



**Board:**

Mark Elam, Chairman      Richard (Rick) Toomey, DHA, FACHE  
David W. Gillespie, MD, Vice-Chairman      Seema Shrivastava-Patel  
Charles M. Joye II, P.E., Secretary      Jim Creel, Jr.

**South Carolina Board of Health and Environmental Control  
Agenda  
October 12, 2018**

***Call to Order - 10:00 a.m., Board Room (#3420)***

***South Carolina Department of Health and Environmental Control  
2600 Bull Street, Columbia, S.C.***

1. Minutes of the July 12, 2018 and September 27, 2018 meetings
2. Administrative and Consent Orders issued by Health Regulation
3. Administrative and Consent Orders issued by Environmental Affairs
4. Placement of Epidiolex in Schedule V for Controlled Substances
5. Notice of Proposed Regulation for Repealing Regulation 61-67.1, Requirements for State Water Pollution Control Revolving Fund Loan Assistance
6. Notice of Proposed Regulation Amending Regulation 61-79, Hazardous Waste Management Regulations
7. Notice of Proposed Regulation for Amending Regulation 61-79, Hazardous Waste Management Regulations (exempt from General Assembly Review)
8. Notice of Proposed Regulation for Amending Regulation 61-120, South Carolina Immunization Registry
9. Notice of Proposed Regulation Amending Regulation 61-25, Retail Food Establishments, and Repealing Regulation 61-37, Retail Food Establishment Inspection Fees
10. Notice of Proposed Regulation Amending Regulation 61-56, Onsite Wastewater Systems, and repealing Regulation 61-55, Septic Tank Site Evaluation Fees, Regulation 61-56.1, License to Construct or Clean Onsite Sewage Treatment and Self-Contained Toilets, Regulation 61-56.2, Licensing of Onsite Wastewater Systems Master Contractors
11. Proposed Meeting Dates for 2019
12. Agency Affairs

Executive Session (if needed)

Adjournment

*Notes: The next scheduled meeting is November 8.*

SUMMARY SHEET  
SOUTH CAROLINA BOARD OF HEALTH AND ENVIRONMENTAL CONTROL

October 11, 2018

( ) ACTION/DECISION

(X) INFORMATION

- I. TITLE:** Health Regulation Administrative and Consent Orders.
- II. SUBJECT:** Health Regulation Administrative Orders, Consent Orders, and Emergency Suspension Orders for the period of June 1, 2018, through August 31, 2018.
- III. FACTS:** For the period of June 1, 2018, through August 31, 2018, Health Regulation reports one (1) Administrative Order and thirteen (13) Consent Orders totaling seventy-two thousand four hundred fifty dollars (\$72,450) in assessed monetary penalties.

Health Regulation Bureau	Health Care Facility, Provider, or Equipment	Administrative Orders	Consent Orders	Emergency Suspension Orders	Assessed Penalties
Health Facilities Licensing	Community Residential Care Facility	1	3	0	\$42,000
	Adult Day Care Facility	0	1	0	\$2,000
	Body Piercing Facility	0	1	0	\$0
	Hospice Program	0	1	0	\$17,700
	Tattoo Facility	0	1	0	\$6,700
	Midwives	0	1	0	\$0
EMS & Trauma	Paramedic	0	2	0	\$0
Radiological Health	X-Ray	0	3	0	\$4,050
<b>TOTAL</b>		<b>1</b>	<b>13</b>	<b>0</b>	<b>\$72,450</b>

Approved By:



Shelly Bezanson Kelly  
Director of Health Regulation

HEALTH REGULATION ENFORCEMENT REPORT  
SOUTH CAROLINA BOARD OF HEALTH AND ENVIRONMENTAL CONTROL

October 11, 2018

**Bureau of Health Facilities Licensing**

Facility Type	Total # of Beds	Total # of Licensed Facilities in South Carolina
Community Residential Care Facilities	19,701	487

**1. Haven in the Summit (CRCF) – Columbia, SC**

Investigation: The Department visited Haven in the Summit (“Haven”) on March 8, 2016, January 11, 2017, and April 5, 2017, to conduct general inspections, and March 9, 2017, and April 27, 2017, to conduct complaint investigations.

Violations: Based upon the inspections and investigations, the Department cited Haven for thirty (30) violations of Regulation 61-84, Standards for Licensing Community Residential Care Facilities. Specifically, Haven was cited three (3) times for violating Section 401, for failing to implement facility policies; one (1) time for violating Section 505.A, for failing to have documentation of a two-step tuberculin skin test for a staff member; three (3) times for violating Section 601, for failing to follow incident reporting requirements; two (2) times for violating Section 701.B.6, for failing to document notes of observation in residents’ records on at least a monthly basis and failing to document notes of observation in a resident’s record on a daily basis until the resident’s condition stabilized; three (3) times for violating Section 702, for failing to have documentation of a resident’s assessment and failing to ensure assessments were conducted no later than seventy-two (72) hours after admission; six (6) times for violating Section 703, for failing to timely complete individual care plans and failing to ensure all required information was entered; one (1) time for violating Section 801.D.3, by retaining a resident requiring the skills of a licensed nurse in excess of fourteen (14) consecutive days; three (3) times for violating Section 1101.A, for failing to comply with physical examination requirements for residents; one (1) time for violating Section 1203.F, for failing to ensure reviews of medical administration records were conducted at shift change; two (2) times for violating Section 1206.C.2, for failing to ensure reviews of control sheets were conducted at shift change; two (2) times for violating Section 1601, for failing to keep all equipment and building components in good repair and operating condition; one (1) time for violating Section 1702.A, for failing to record the millimeters of induration for the first step of a resident’s tuberculin skin test; one (1) time for violating Section 1702.D.2.a, for failing to ensure tuberculin skin tests for staff members were completed prior to resident contact; and one (1) time for violating Section 2602.A.1, for failing to ensure mattresses on resident beds had moisture-proof covers.

Enforcement Action: Pursuant to the Consent Order executed June 1, 2018, the Department assessed a fourteen thousand five hundred dollar (\$14,500) monetary penalty against Haven. The Consent Order required Haven to submit eight thousand dollars (\$8,000) of the assessed monetary penalty within thirty (30) days of execution of the Consent Order. The remainder of the assessed monetary penalty will be stayed upon a six (6) month period of substantial compliance with R.61-84 and the Consent Order. Additionally, Haven agreed to initiate action to correct the violations that initiated this enforcement action. Finally, Haven agreed to schedule and attend a compliance assistance meeting with Department representatives within forty-five (45) days of execution of the Consent Order. The monetary penalty was paid July 12, 2018.

Prior Sanctions: None.

**2. Anderson Oaks Assisted Living (CRCF) – Conway, SC**

Investigation: The Department visited Anderson Oaks Assisted Living (“Anderson”) on June 1, 2016, and August 29, 2017, to conduct general inspections.

Violations: Based upon the inspections and investigations, the Department cited Anderson for eighteen (18) violations of Regulation 61-84, Standards for Licensing Community Residential Care Facilities. Specifically, Anderson was cited two (2) times for violating Section 501.A, for failing to ensure criminal background checks for staff members were conducted

prior to hiring; one (1) time for violating Section 701.B.6, for failing to document daily notes of observation for changes in a resident's condition; two (2) times for violating Section 702, for failing to follow requirements for resident assessments; one (1) time for violating Section 703.B.1, for failing to ensure a resident's Individual Care Plan included wound care provided by a hospice provider; one (1) time for violating Section 801.C.8, for retaining a resident inappropriate for care in a CRCF for more than fourteen (14) consecutive days; two (2) times for violating Section 1101.A, for failing to follow physical examination requirements; four (4) times for violating Section 1702, for failing to maintain compliance with tuberculosis screening requirements; two (2) times for violating Section 1703.A.3, for failing to safely store harmful chemicals; one (1) time for violating Section 1706.B.3, for failing to ensure soiled linen and clothing containers were covered or enclosed; one (1) time for violating Section 2104.A, for failing to conspicuously post "No Smoking" signs in the vicinity of oxygen administration or storage; and one (1) time for violating Section 2301.B, for failing to ensure hot water fixtures accessible to residents did not exceed one hundred twenty (120) degrees Fahrenheit.

Enforcement Action: Pursuant to the Consent Order executed July 13, 2018, the Department assessed a nine thousand dollar (\$9,000) monetary penalty against Anderson. The Consent Order required Anderson to submit five thousand dollars (\$5,000) of the assessed monetary penalty within thirty (30) days of execution of the Consent Order. The remainder of the assessed monetary penalty will be stayed upon a six (6) month period of substantial compliance with R.61-84 and the Consent Order. Additionally, Anderson agreed to initiate action to correct the violations that initiated this enforcement action. Finally, Anderson agreed to schedule and attend a compliance assistance meeting with Department representatives within forty-five (45) days of execution of the Consent Order. The monetary penalty was paid July 11, 2018.

Prior Sanctions: None.

### **3. Harborchase of Aiken (CRCF) – Aiken, SC**

Investigation: The Department visited Harborchase of Aiken (Harborchase or the Facility) to conduct general inspections on September 26, 2016 and October 6, 2017, follow-up inspections on December 9, 2016, March 10, 2017 and January 5, 2018, and food and sanitation inspections on November 3, 2016, December 9, 2016 and October 6, 2017.

Violations: Based upon the inspections, the Department cited Harborchase for violations of Regulation 61-84, Standards for Licensing Community Residential Care Facilities. Specifically, Harborchase was cited one (1) time for violation of 61-84 Section 501.A, by failing to have documentation of a criminal background check for a staff member; two (2) times for violation of 61-84 Section 504.A, by failing to have documentation of inservice training for a staff member available and by failing to ensure that annual inservice training in OSHA standards regarding blood-borne pathogens for a staff member was signed and dated by the individual receiving the training; one (1) time for violation of 61-84 Section 504.A.5, by failing to ensure that training in specific person care for a staff member was conducted prior to initial resident contact; one (1) time for violation of 61-84 Section 604.B.1, by failing to notify the Department within 72 hours of a change in administrator status and by failing to provide to the Department in writing within ten days the name of a newly-appointed administrator, the effective date of appointment, a copy of the administrator's license, and the hours each day the individual will be working as the administrator of the Facility; one (1) time for violation of 61-84 Section 702, by failing to have a resident's written assessment available and by failing to complete a resident's written assessment within 72 hours of admission; four (4) times for violation of 61-84 Section 703.A, by failing to ensure a resident's ICP was signed and dated by the administrator (or designee), and/or the sponsor or responsible party when appropriate, by failing to ensure residents' ICPs were developed within seven days of admission, by failing to ensure residents' ICPs were reviewed and/or revised at least semi-annually, and by failing to ensure a resident's ICP was available; two (2) times for violation of 61-84 Section 801.D.2, by retaining residents who were dependent in all ADLs for more than 14 consecutive days; one (1) time for violation of 61-84 Section 801.D.3, by retaining a resident needing the continuous daily attention of a licensed nurse for more than 14 consecutive days; two (2) times for violation of 61-84 Section 801.F, by failing to transfer a resident in need of continuous nursing supervision within 30 days to a location capable of providing for the resident's needs and by failing to coordinate the transfers of two residents in need of continuous nursing supervision with the residents, next-of-kin/responsible party, and sponsor; one (1) time for violation of 61-84 Section 901.C, by failing to administer a resident's medication as prescribed by the physician or other authorized healthcare provider; two (2) times for violation of 61-84 Section 1101.A, by failing to conduct residents' physical examinations annually and by failing ensure a resident's physical examination addressed the resident's self-administration status, the appropriateness of placement in a CRCF, and the need of (or lack thereof) for the continuous daily attention of a licensed nurse; one (1) time for violation of 61-84 Section 1203.A, by failing to properly record the administration of medications to residents by initialing on the residents' MARs as the medications were administered; one (1) time for violation of 61-84 Section 1203.A, by failing to properly record the administration of medications to residents



by initialing on the residents' MARs as the medications were administered; three (3) times for violation of 61-84 Section 1301.A, by failing to ensure the Facility's food preparation met the requirements of Regulation 61-25, *Retail Food Establishments*; two (2) time for violation of 61-84 Section 1702.E.1.a.1, by failing to have documentation of the second step of residents' two-step TSTs available; one (1) time for violation of 61-84 Section 1706.B.3, by failing to ensure soiled clothing and linens were kept in enclosed/covered containers; and, three (3) times for violation of 61-84 Section 2301.B, by failing to ensure hot water supplied to plumbing fixtures was at least 100 degrees F, but not to exceed 120 degrees F.

Enforcement Action: By Consent Order (CO-HL-12-2018) executed August 13, 2018, the Department assessed a \$13,500 monetary penalty against Harborchase for its violations of Regulation 61-84. Harborchase was required to pay \$8,000 of the assessed monetary penalty to the Department within 30 days of the date of execution of the Consent Order. The remaining \$5,500 of the assessed monetary penalty was stayed upon a six-month period of substantial compliance with Regulation 61-84 and the Consent Order, as determined by the Department. Additionally, the Facility was required to initiate action to correct the violations that initiated the enforcement action and to ensure that all violations of Regulation 61-84 are not repeated, and to schedule and attend a compliance assistance meeting with representatives of the Department's Bureau of Health Facilities Licensing within 45 days of execution of the Consent Order.

Prior Sanctions: None.

#### **4. Betty A. Miles (Unlicensed CRCF) – Columbia, SC**

Investigation: The Department visited 490 Koon Store Road, Columbia, S.C. 29203-9573 on July 3, 2018 to conduct a complaint investigation.

Violations: Based upon the inspections, the Department cited Betty A. Miles for a violation of Regulation 61-84, Standards for Licensing Community Residential Care Facilities. Specifically, Mrs. Miles was cited one (1) time for violation of S.C. Code Ann. Section 44-7-260(A)(6) (2017 and 61-84 Section 103.A (Supp. 2017) by operating an unlicensed community residential care facility (CRCF) at 490 Koon Store Road, Columbia, S.C. 29203-9573.

Enforcement Action: By Administrative Order, executed August 29, 2018, the Department assessed Mrs. Miles a \$5,000 civil monetary penalty within 30 days of execution of the Administrative Order. Additionally, Mrs. Miles was ordered to immediately cease operating 490 Koon Store Road, Columbia, S.C. 29203-9573 as a CRCF, unless and until she obtained licensure<sup>1</sup> from the Department, and to ensure the safety, health, and well-being of the occupants of the Facility.

Prior Sanctions:

1. By Consent Order (CO-HL-08-2012), executed February 5, 2013, the Department assessed Miles Residential Care<sup>2</sup> (Miles) a civil monetary penalty in the amount of \$21,500 for its violations of Regulation 61-84. Miles Residential Care was required to pay to the Department \$4,800 of the assessed monetary penalty in twelve (12) monthly installments of \$400. The remainder of the assessed penalty (\$16,700) was stayed upon Miles Residential Care remaining in substantial compliance with Regulation 61-84 and the Consent Order for 12 months. Additionally, the Facility was required to initiate action to correct the violations that initiated the enforcement action, and scheduled and attend a compliance assistance meeting with representatives of the Department within 45 days of execution of the Consent Order. At the time of the compliance assistance meeting, the Facility was required to schedule a date and time for Department representatives to conduct food service training for the Facility's staff at the location of Miles Residential Care.
2. By Administrative Order, executed October 10, 2016, the Department revoked the license of Miles Residential Care to operate as a CRCF for its violations<sup>3</sup> and noncompliance with Regulation 61-84.

<sup>1</sup> According to the Richland County Public Index, on July 4, 2018, an officer from the Richland County Sheriff's Office arrested Ms. Miles and charged her with four counts of knowingly and willfully neglecting a vulnerable adult. See S.C. Code Ann. § 43-35-85(C). Pursuant to S.C. Code Ann. Section 44-7-264(B)(1)(a), the Department must not issue a CRCF license to an applicant who has been convicted of neglect of a vulnerable adult, as defined by Section 43-35-10.

<sup>2</sup> Betty A. Miles and Louis B. Miles held license number CRC-0695 to operate Miles Residential Care, 490 Koon Store Road, Columbia, S.C. 20203-9573 as a CRCF. Miles was license by the Department since December 10, 1992 and licensed for a total of 7 beds. Mrs. Miles was the administrator and owner of the parcel of land located at 490 Koon Store Road, Columbia, S.C.

<sup>3</sup> Between January 16, 2014 and June 15, 2016 the Department cited Miles Residential Care for 141 violations of Regulation 61-84,

Facility Type	Total # of Participants	Total # of Licensed Facilities in South Carolina
Day Care Facilities for Adults	4,570	95

**5. Ruth Louis Adult Health Day Care #2 (ADC) – Kingstree, SC**

Investigation: The Department visited Ruth Louis Adult Health Day Care #2 (“Ruth”) on December 16, 2015, and March 23, 2017, to conduct general inspections, and May 31, 2016, to conduct a follow-up inspection.

Violations: Based upon the inspections and investigations, the Department cited Ruth for twenty-nine (29) violations of Regulation 61-75, Standards for Licensing Day Care Facilities for Adults. Specifically, Ruth was cited one (1) time for violating Section 202.D, for failing to timely submit a Plan of Correction for the violations cited during the May 2016 follow-up inspection; three (3) times for violating Section 404, for failing to have documentation of criminal background checks for staff members and failing to maintain accurate and current information for staff members; one (1) time for violating Section 404.D, for failing to have documentation of health assessments for staff members; eight (8) times for violating Sections 404.E and 404.F, for failing to have documentation of required training for staff members; two (2) times for violating Section 404.G, for failing to have documentation of an annual performance evaluation and current job description for a staff member, and failing to maintain personnel files for staff members; one (1) time for violating Section 404.H, for failing to have documentation of CPR certification for at least one staff member present with participants; two (2) times for violating Section 503.A.1, for failing to include pictures of participants in participant records; three (3) times for violating Sections 503.A.2 and 503.A.3, for failing to follow pre-enrollment physical examination requirements for participants and failing to include the physician’s contact information in participant records; three (3) times for violating Section 503.A.4, for failing to have documentation of Individual Plans of Care, initial assessments, and quarterly notes of observation for participants; one (1) time for violating Section 803.B, for failing to store cleaning materials in a locked closet or cabinet; one (1) time for violating Section 803.D, for failing to keep floors in good repair and free from hazards; one (1) time for violating Section 807.A, for failing to have documentation of an annual tuberculosis risk assessment; one (1) time for violating Section 1201, for failing to maintain its equipment in good repair; and one (1) time for violating Section 1203.C, for failing to ensure the men’s restroom for participants had a covered waste receptacle.

Enforcement Action: Pursuant to the Consent Order executed July 14, 2018, the Department assessed a two thousand dollar (\$2,000) monetary penalty against Ruth. The Consent Order required Ruth to submit eight hundred dollars (\$800) of the assessed monetary penalty within thirty (30) days of execution of the Consent Order. The remainder of the assessed monetary penalty will be stayed upon a six (6) month period of substantial compliance with R.61-75 and the Consent Order. Additionally, Ruth agreed to initiate action to correct the violations that initiated this enforcement action. The monetary penalty was paid July 10, 2018.

Prior Sanctions: None.

Facility Type	Total # of Licensed Facilities in South Carolina
Body Piercing Facilities	37

**6. Abnormal Gifts (Body Piercing Facility) – Easley, SC**

Investigation: The Department visited Abnormal Gifts (“Abnormal”) on November 30, 2016, to conduct a routine inspection.

Violations: Based upon the inspections, the Department cited Abnormal for four (4) violations of Regulation 61-109, Standards for Permitting Body Piercing Facilities. Specifically, Abnormal was cited two (2) times for violating Section

which included 56 Class I violations, 72 Class II violations and 13 Class III violations.

302.D, for failing to timely submit a Plan of Correction for the violations cited during the November 2016 inspection; one (1) time for violating Section 1003, for failing to have documentation of charges for body piercing procedures performed; and one (1) time for violating Section 1202.A, for failing to have documentation of Hepatitis B vaccinations for technicians, or an offer and refusal, or documentation that the vaccine was contraindicated.

Enforcement Action: Pursuant to the Consent Order executed July 23, 2018, the Department placed Abnormal on probation until the conditions of the Consent Order are satisfied, as determined by the Department. Additionally, pursuant to the terms of the Consent Order, Abnormal was required to post a probationary letter from the Department in a conspicuous location in the facility. Moreover, Abnormal agreed to correct the violations which prompted this enforcement action, ensure that all violations of R.61-109 are not repeated, and schedule and attend a compliance assistance meeting with Department representatives within forty-five (45) days of execution of the Consent Order. Finally, Abnormal acknowledged that the Department will conduct a follow-up inspection within thirty (30) days following the compliance assistance meeting. If no violations are found during the follow-up inspection, the probation will be lifted. However, if violations are found, Abnormal will be required to timely submit an acceptable Plan of Correction (“POC”). Upon receipt of an acceptable POC, the Department will lift the probation.

Prior Sanctions: None.

Facility Type	Total # of Licensed Outpatient Hospices in South Carolina	Total # of Counties Served
Hospice Programs	1,650	88

## 7. Hospice Care of Sumter (Hospice Program) – Sumter, SC

Investigation: The Department visited Hospice Care of Sumter (the Facility) to conduct a general inspection on February 2, 2016, a complaint investigation on April 7, 2017 and follow-up inspections on November 4, 2016 and February 10, 2017. Additionally, the Department issued citations-by-mail on February 8, 2017 and March 10, 2017.

Violations: Based upon the inspections, the Department cited Hospice Care of Sumter for violations of Regulation 61-78, Standards for Licensing Hospices. Specifically, Hospice Care of Sumter was cited two (2) times for violation of 61-78 Section 302.D (Supp. 2016), by failing to timely submit a POC for the violations cited as a result of inspections; two (2) times for violation of 61-78 Section 601.B (Supp. 2016), by failing to have documentation of criminal background checks for staff members; two (2) times for violation of 61-78 Section 501.C (Supp. 2016), by failing to have documentation of assigned duties and responsibilities for staff members; one (1) time for violation of 61-78 Section 505.A.1 (2012), by failing to have documentation of training in management/care of persons with contagious and/or communicable diseases for a staff member; one (1) time for violation of 61-78 Section 505.A.2 (2012), by failing to have documentation of training in care of persons specific to the physical/mental condition being cared for by the hospice for a staff member; one (1) time for violation of 61-78 Section 505.A.3 (2012) and one (1) time for a violation of Section 605.A.3 (Supp.2016), by failing to have documentation of training in use of restraints for designated staff members; one (1) time for violation of 61-78 Section 505.A.4 (2012) and one (1) time for Section 605.A.4 (Supp. 2016), by failing to have documentation of training in OSHA standards regarding bloodborne pathogens for staff members; one (1) time for violation of 61-78 Section 505.A.6, by failing to have documentation of training in confidentiality of patient information and records and the protection of patient rights for a staff member; one (1) time for violation of 61-78 Section 505.B (2012) and one (1) time for Section 605.B (Supp. 2016), by failing to have documentation of orientation for staff members; one (1) time for violation of 61-78 Section 506.A (2012) and one time for violation of Section 606.A (Supp. 2016), by failing to have documentation of health assessments for staff members; one (1) time for violation of 61-78 Section 702.B.2 (2012), by failing to ensure all orders for care from physicians or other authorized healthcare providers are completed prior to, or at the time of admission, and updated when revised; two (2) times for violation of 61-78 Section 802.B.3 (Supp. 2016), by failing to have documentation of care, treatment, and services provided; one (1) time for violation of 61-78 Section 802.B.7 (Supp. 2016), by failing to have documentation of the time and circumstances of a patient’s death; one (1) time for violation of 61-78 Section 704 (2012), by failing to develop a plan of care for a patient within 48 hours of admission. In addition, the Facility violated Section 804 (Supp. 2016) on February 10, 2017, by failing to have documentation of plans of care for patients; one (1) time for violation of 61-78 Section 801.C.1 (2012), by failing to have documentation verifying that a patient was certified by the physician to

be terminally ill; one (1) time for violation of 61-78 Section 801.C.4 (2012) and one time (1) time for violation of Section 900.C.4 (Supp. 2016), by failing to have documentation verifying patients are not likely to endanger themselves or others as determined by a physician or other authorized healthcare provider; one (1) time for violation of 61-78 Section 1200.A (Supp. 2016), by failing to have documentation of medical history and physical assessment for patients; one (1) time for violation of 61-78 Section 1202.B.1 (2012) and one (1) time for a violation of Section 1303.B.1 (Supp. 2016), by failing to have documentation of two-step TSTs for staff members; one (1) time for violation of 61-78 Section 1401.A (2012) and one (1) time for a violation of Section 1500.A (Supp. 2016), by failing to have documentation of a written, implemented quality improvement program; and, one (1) time for violation of 61-75 Section 1602.A (Supp. 2016), by failing to ensure a verbal order for treatment was signed by a physician and received by an authorized healthcare provider.

**Enforcement Action:** By Consent Order (CO-HL-03-2018), executed August 8, 2018, the Department assessed a \$17,700 monetary penalty against Hospice Care of Sumter for its violations of Regulation 61-78. Hospice Care of Sumter was required to pay \$10,000 of the assessed monetary penalty to the Department in five (5) consecutive installment of \$2,000. The remaining \$7,700 of the assessed monetary penalty was stayed upon a six-month period of substantial compliance with Regulation 61-78 and the Consent Order, as determined by the Department. Additionally, Hospice Care of Sumter was required to initiate action to correct the violations that initiated the enforcement action and to ensure that all violations of Regulation 61-78 are not repeated.

**Prior Sanctions:** None.

Facility Type	Total # of Participants	Total # of Licensed Facilities in South Carolina
Tattoo Facilities	4,570	95

**8. Devine Street Tattoo (Tattoo Facility) – Columbia, SC**

**Investigation:** The Department visited Devine Street Tattoo to conduct a routine inspection on April 21, 2017 and a follow-up inspection on July 14, 2017. Additionally, the Department issued a citation-by mail on August 1, 2017 for Devine Street Tattoo's failure to provide a plan of correction (POC) to the April 21, 2017 inspection report of visit.

**Violations:** Based upon the inspections, the Department cited Devine Street Tattoo for violations of Regulation 61-111, Standards for Licensing Tattoo Facilities. Specifically, Devine Street Tattoo was cited one (1) time for violation of 61-111 Section 301.C, by failing to allow Department representatives access to all objects at the time of the inspection; one (1) time for violation of 61-111 Section 302.D, by failing to submit an acceptable POC to the violations cited as a result of the Department's inspection on April 21, 2017; one (1) time for violation of 61-111 Section 500.A, by failing to have documentation of policies and procedures. In addition, the Facility violated Section 500.A on July 14, 2017, by failing to implement its policies and procedures; one (1) time for violation of 61-111 Section 601.D, by failing to have documentation of training backgrounds for staff members; one (1) time for violation of 61-111 Section 801.B.1, by failing to have documentation of a means of verification of a client's identity; two (2) times for violation of 61-111 Section 801.B.2, by failing to ensure the explanation of client rights and informed consents for clients were signed by the tattoo artist; two (2) times for violation of 61-111 Section 801.B.3, by failing to have documentation of the site of tattoo procedures performed; one (1) time for violation of 61-111 Section 801.B.6, by failing to ensure documentation of emergency contact information for clients included an address; one (1) time for violation of 61-111 Section 1204.E, by failing to test the effectiveness of the autoclave in killing bacterial endospores on a monthly basis; one (1) time for violation of 61-111 Section 1205.A.3, by failing to store chemicals and cleaning materials in a cabinet, closet, or room that is inaccessible to clients; one (1) time for violation of 61-111 Section 1602.A.3, by failing to ensure a sink with hot running water was provided for every five work stations for hand washing; was cited one (1) time for violation of 61-111 Section 1603.B, by failing to ensure expired supplies are removed from the Facility and destroyed; and, one (1) time for violation of 61-111 Section 1701, by failing to ensure fire extinguishers are provided as required by the applicable codes in Section 1502.

**Enforcement Action:** By Consent Order (CO-HL-08-2018), executed August 21, 2018, the Department assessed a \$6,700 monetary penalty against Devine Street Tattoo for its violations of Regulation 61-111. Devine Street Tattoo was required to pay \$4,000 of the assessed monetary penalty to the Department within 30 days of execution of the Consent Order. The

remaining \$2,700 of the assessed monetary penalty was stayed upon a six-month period of substantial compliance with Regulation 61-111 and the Consent Order, as determined by the Department. Additionally, Devine Street Tattoo was required to initiate action to correct the violations that initiated the enforcement action and to ensure that all violations of Regulation 61-111 are not repeated, and to schedule and attend a compliance assistance meeting with representatives of the Department's Bureau of Health Facilities Licensing within 45 days of execution of the Consent Order.

Prior Sanctions: None.

License Type	Total # of Licensed Midwives
Midwives	43

**9. Linda Weaver (Midwife) – Spartanburg, SC**

Investigation: The Department conducted a complaint investigation on July 24, 2018, which included reviews of a mother's and a newborn's record.

Violations: Based upon the investigation, the Department cited Linda Weaver for violations of Regulation 61-24, Midwives. Specifically, Linda Weaver was cited one (1) time for violation of 61-24 Section K.34 (Supp. 2017), for failing to obtain medical consultation, or refer for medical care, a mother who had meconium-stained amniotic fluid; and, one (1) time for violation of 61-24 Section M.1 (Supp. 2017), for failing to carry out emergency measures in the absence of medical help.

Enforcement Action: By Consent Order (CO-HL-14-2018), executed August 31, 2018, the Consent Order imposed a 90-day suspension of Ms. Weaver's midwife license which was held in abeyance pending her completion of a training module entitled, *Fetal Assessment In Labor*, available through HiveCR: Online Continuing Education for Midwives. Additionally, Ms. Weaver was required to submit proof of completion of the training module within thirty days of execution of the Consent Order and to implement action to correct the violations that initiated this enforcement action and to ensure that all violations of Regulation 61-24 are not repeated. The Department received evidence of completion of the training module on August 28, 2018.

Prior Sanctions: None.

**Bureau of EMS & Trauma**

EMS Provider Type	Total # of Providers in South Carolina
EMT	6,218
Advanced EMT	399
Paramedic	3,688
Athletic Trainers	1,000
Ambulance Services Provider	264
First Responder Services Provider	2

## **10. Harry R. Hill, II (Paramedic)**

Investigation: The Department received notification that an EMT class was being instructed by an individual that was not certified as an EMT instructor. The Department initiated an investigation and made the following findings. On November 13, 2017, Mr. Hill acted as the lead instructor for Class 0100051, an EMT-Basic course conducted by Spartanburg Community College Continuing Education at the Boiling Springs Fire Department. Mr. Hill was the only instructor present and teaching the course. Mr. Hill does not hold a current South Carolina instructor certification at any level.

Violations: As a result of its investigation, the Department found Mr. Hill committed misconduct, as defined by S.C. Code Section 44-61-80(F)(17) and Section 1100(B)(17) of Regulation 61-7, Emergency Medical Services, by violating S.C. Code Section 44-61-80(G) and Section 907(E) of Regulation 61-7, which require that instructors of EMT courses be certified by the Department and all training courses be supervised by certified instructors.

Enforcement Action: Pursuant to the Consent Order executed June 20, 2018, Mr. Hill agreed to not supervise or instruct any EMT-Basic, Advanced, or Paramedic classes in South Carolina. Mr. Hill further agreed to not submit to the Department an application for instructor certification for a period of one (1) year from execution of the Consent Order.

Prior Sanctions: None.

## **11. Matthew C. McLellan (Paramedic)**

Investigation: The Department received allegations regarding the standard of care provided by Mr. McLellan while working for Florence County EMS. The Department initiated an investigation and made the following findings. On October 22, 2017, Mr. McLellan violated protocol by ambulating a patient who was suffering from respiratory distress and shortness of breath. The patient subsequently deteriorated during transport, became unresponsive, and went into cardiac arrest. On October 24, 2017, Mr. McLellan violated protocol by failing to perform a 12-lead EKG on a patient exhibiting signs and symptoms of cardiac illness and/or injury. The patient refused transport to the hospital, but patient care report did not include the patient's informed refusal, the EMT's efforts to convince the patient to accept care, and efforts by the EMTs to protect the patient after the refusal. The patient later presented to a hospital emergency room in cardiac arrest.

Violations: As a result of its investigation, the Department found that Mr. McLellan committed misconduct, as defined by S.C. Code Section 44-61-80(F)(6) and Section 1100(B)(6) of Regulation 61-7, Emergency Medical Services, by disregarding physician orders regarding emergency medical treatment. In addition, the Department found Mr. McLellan committed misconduct, as defined by S.C. Code Section 44-61-80(F)(17) and Section 1100(B)(17) of Regulation 61-7, by violating Regulation 61-7, Section 1303(c), which requires PCRs involving refusals to include, among other things, information regarding the provider's efforts to convince the patient to accept care and efforts by the provider to protect the patient after the refusal if the patient becomes incapacitated.

Enforcement Action: Pursuant to the Consent Order executed August 2, 2018, Mr. McLellan agreed to immediately surrender his paramedic certification and will be issued an advanced EMT certification for a period of one-year or upon submission of proof of successful completion of prescribed course.

Prior Sanctions: None.

### **Bureau of Radiological Health**

## **12. Ashley Dental Associates, P.A. (X-Ray Facility)**

Investigation: On January 9, 2018, the Department conducted a routine inspection and found that Ashley Dental Associates, P.A. failed to show current records of equipment performance records. The Department cited the same violations during inspections on November 26, 2007 and March 27, 2013.

Violations: As a result of the investigation, the Department found Ashley Dental Associates, P.A. repeatedly violated Regulation 61-64, X-Rays (Title B), by failing to complete equipment performance testing.

Enforcement Action: Pursuant to the Consent Order executed August 28, 2018, the Department assessed a \$1,700 monetary penalty with \$425 due within 30 days of the execution of the Consent Order and \$1,275 stayed. The Department reserved the right to collect the stayed amount if Ashley Dental Associates, P.A failed to pay the initial balance within 30 days or was found to be not compliant with Regulation 61-64, RHB 4.2.16.1 during the 36 months following the Consent Order.

Prior Sanctions: None.

### **13. Interstate Health Physics Consulting, LLC (X-Ray Vendor)**

Investigation: On March 23, 2018, the Department received an Equipment Replacement Notification signed by Interstate Health Physics Consulting, LLC's Bruce Gossett, for Palmetto Wellness & Injury Center, that indicated Carolina Radiology Solutions as the sales vendor. On March 29, 2018, the Department received documentation that indicted that Mr. Gossett was aware that the actual vendor where the equipment was purchased was not registered in SC. On April 3, 2018, the Department received a Report of Sale or Installation of X-Ray Equipment from Sharp Medical, Inc., indicating his company sold x-ray equipment at Palmetto Wellness & Injury Center. On April 9, 2018, the Department received a letter from Carolina Radiology Solutions indicating that Mr. Gossett contacted the company to obtain their vendor number for use for the Palmetto Wellness & Injury Center installation.

Violations: As a result of the investigation, the department found that Interstate Health Physics Consulting, LLC violated Regulation 61-64, X-Rays (Title B), by making a material false statement to the Department.

Enforcement Action: Pursuant to the Consent Order executed July 30, 2018, the Department assessed a \$650 civil penalty with \$450 due within 30 days of the execution on the Consent Order and \$200 stayed. The Department reserved the right to collect the stayed amount if Interstate Health Physics Consulting, LLC failed to pay the initial balance within 30 days or was found to be not compliant with Regulation 61-64, RHB 1.12.2.

Prior Sanctions: None.

### **14. Charleston Non-Surgical Center, LLC (X-Ray Facility)**

Investigation: On January 9, 2018, the Department conducted a routine inspection and found that Charleston Non-Surgical Center, LLC failed to show current records of equipment performance testing. The Department cited the same violations during inspections on April 18, 2012 and March 26, 2015.

Violations: As a result of the investigation, the Department found that Charleston Non-Surgical Center, LLC repeatedly violated Regulation 61-64, X-Rays (Title B), by failing to complete equipment performance testing.

Enforcement Action: Pursuant to the Consent Order executed August 28, 2018, the Department assessed a \$1,700 monetary penalty with \$425 due within 30 days of the execution of the Consent Order and \$1,275 stayed. The Department reserved the right to collect the stayed amount if Charleston Non-Surgical Center, LLC failed to pay the initial balance within 30 days or was found to be not compliant with Regulation 61-64, RHB 4.2.16.1 during the 24 months following the Consent Order.

Prior Sanctions: None.

SUMMARY SHEET  
BOARD OF HEALTH AND ENVIRONMENTAL CONTROL  
October 11, 2018

\_\_\_\_\_ ACTION/DECISION

X  INFORMATION

- 1. TITLE:** Administrative and Consent Orders issued by the Office of Environmental Affairs.
- 2. SUBJECT:** Administrative and Consent Orders issued by the Office of Environmental Affairs during the period June 1, 2018 through August 31, 2018.
- 3. FACTS:** For the period of June 1, 2018 through August 31, 2018, the Office of Environmental Affairs issued two hundred sixty-four (264) Consent Orders with total assessed civil penalties in the amount of four hundred five thousand, one hundred fifty five dollars \$405,155.00 and twenty-one (21) Administrative Orders with total assessed civil penalties in the amount of two hundred forty five thousand, six hundred eighty seven dollars and 50 cents \$245,687.50.

Bureau and Program Area	Administrative Orders	Assessed Penalties	Consent Agreements	Consent Orders	Assessed Penalties
<b>Land and Waste Management</b>					
UST Program	13	\$224,750.00	0	3	\$3,000.00
Aboveground Tanks	0	0	0	0	0
Solid Waste	1	\$5,937.50	0	4	\$11,500.00
Hazardous Waste	0	0	0	3	\$16,750.00
Infectious Waste	0	0	0	4	\$18,405.00
Mining	0	0	0	1	\$1,000.00
<b>SUBTOTAL</b>	<b>14</b>	<b>\$230,687.50</b>	<b>0</b>	<b>15</b>	<b>\$50,655.00</b>
<b>Water</b>					
Recreational Water	1	\$9,000.00	0	62	\$66,350.00
Drinking Water	0	0	0	8	\$8,000.00
Water Pollution	0	0	0	17	\$51,750.00
Dam Safety	0	0	0	1	0
<b>SUBTOTAL</b>	<b>1</b>	<b>\$9,000.00</b>	<b>0</b>	<b>88</b>	<b>\$126,100.00</b>
<b>Air Quality</b>					
<b>SUBTOTAL</b>	<b>0</b>	<b>0</b>	<b>0</b>	<b>8</b>	<b>\$70,450.00</b>
<b>Environmental Health Services</b>					
Food Safety	3	\$4,000.00	0	148	\$156,850.00
Onsite Wastewater	3	\$2,000.00	0	3	\$1,000.00
<b>SUBTOTAL</b>	<b>6</b>	<b>\$6,000.00</b>	<b>0</b>	<b>151</b>	<b>\$157,850.00</b>
<b>OCRM</b>					
<b>SUBTOTAL</b>	<b>0</b>	<b>0</b>	<b>0</b>	<b>2</b>	<b>\$100.00</b>
<b>TOTAL</b>	<b>21</b>	<b>\$245,687.50</b>	<b>0</b>	<b>264</b>	<b>\$405,155.00</b>

Submitted by:



Myra C. Reece  
Director of Environmental Affairs



**ENVIRONMENTAL AFFAIRS ENFORCEMENT REPORT  
BOARD OF HEALTH AND ENVIRONMENTAL CONTROL  
October 11, 2018**

**BUREAU OF LAND AND WASTE MANAGEMENT**

**Underground Storage Tank Enforcement**

- 1) Order Type and Number: Administrative Order 17-0439-UST  
Order Date: May 8, 2018  
Individual/Entity: **Sanjay & Ulka Patel**  
Facility: Forestbrook Grocery  
Location: 1272 Forestbrook Road  
Myrtle Beach, SC 29579  
Mailing Address: 2521 Hunters Trail  
Myrtle Beach, SC 29588  
County: Horry  
\*Previous Orders: AO 14-0176-UST (\$14,250.00)  
Permit/ID Number: 17398  
Violations Cited: The State Underground Petroleum Environmental Response Bank Act of 1988 (SUPERB Act), S.C. code Ann. § 44-26-10 (2002 and Supp. 2016); and South Carolina Underground Storage Tank Control Regulation, 7 S.C. Code Ann. Regs. 61-92.280.31 (a), 280.31(c), 280.34(c), 280.40(a), 280.40(a)(2), 280.43(h), 280.50, 280.242(b)(3), 280.242(b)(4), and 280.245 (2017).

Summary: Sanjay and Ulka Patel (Individual/Entity), own and operate underground storage tanks located in Myrtle Beach, South Carolina. The Department conducted an inspection on September 27, 2017 and issued a Notice of Alleged Violation because the rectifier was reading 0 amps; there was no impressed current log available at the inspection; there were no release detection records available at the inspection; there was odorous soil under dispenser 1/2; there was no A/B log and no C operator list available at the inspection. The Individual/Entity has violated the SUPERB Act and the South Carolina Underground Storage Tank Regulation, as follows: failed to maintain the corrosion protection system to continuously provide corrosion protection to the metal components of that portion of the tank and piping that routinely contain regulated substances and are in contact with the ground; failure to inspect the impressed current cathodic protection system every sixty (60) days; failed to provide records to the Department upon request; failed to provide adequate release detection methods for an underground storage tank system; failed to properly maintain release detection equipment; failed to conduct proper release detection using SIR; failed to report a suspected release; failed to validate monthly requirements have been performed; failed to physically visit each assigned facility once a quarter; and failed to designate in writing Class C operators and keep a copy at the Facility.

Action: The Individual/Entity is required to: submit proof that the anode wires have been re-buried in the parking lot; submit proof that the rectifier has been repaired, and current corrosion protection system test results after all repairs have been completed; submit twelve (12) months of SIR records, or tank tightness and line tightness test results for all USTs; submit proof of a valid release detection method; submit site check results for dispenser 1/2 and proof of repairs; submit an A/B Operator log; submit a list of C operators; and pay a civil penalty in the amount of ten thousand, seven hundred dollars **(\$10,700.00)**.

2) Order Type and Number: Administrative Order 17-0312-UST  
Order Date: May 18, 2018  
Individual/Entity: **Teddie Pryor**  
Facility: Pryor's Towing & Radiator LLC  
Location: 2851 Rivers Avenue  
North Charleston, SC 29405-8029  
Mailing Address: 2700 Crestline Drive  
North Charleston, SC 29405  
County: Charleston  
Previous Orders: None  
Permit/ID Number: 11358  
Violations Cited: The State Underground Petroleum Environmental Response Bank Act of 1988 (SUPERB Act), S.C. code Ann. § 44-2-60(A) (2002 and Supp. 2016); and South Carolina Underground Storage Tank Control Regulation, 7 S.C. Code Ann. Regs. 61-92.280.70(c), 280.93(a), and 280.110(c) (2017).

Summary: Teddie Pryor (Individual/Entity), owns underground storage tanks located in North Charleston, South Carolina. On February 23, 2017, the Department issued a Notice of Alleged Violation/Notice of Enforcement Conference because the USTs had been temporarily out of service for more than twelve (12) months and did not meet corrosion protection standards; there was no current financial responsibility documentation on file; and the annual tank registration fees for fiscal years 2016, 2017, and 2018 had not been paid. The Individual/Entity has violated the SUPERB Act and the South Carolina Underground Storage Tank Regulation, as follows: failed to pay annual underground storage tank registration fees, failed to permanently close USTs that have been temporarily out of service for greater than twelve (12) months and do not meet current corrosion protection standards, failed to demonstrate financial responsibility for an UST system, and failed to submit evidence of financial assurance to the Department upon request.

Action: The Individual/Entity is required to: submit a completed Tank/Sludge Disposal form; permanently close the USTs and submit an UST Closure and Assessment Report, submit a completed Certificate of Financial Responsibility form and provide evidence of financial assurance if contamination found, pay annual underground storage tank registration fees and associated late fees in the amount of seven thousand, two hundred sixty dollars (\$7,260.00), and pay a civil penalty in the amount of twenty-eight thousand, one hundred dollars (**\$28,100.00**).

3) Order Type and Number: Administrative Order 17-0419-UST  
Order Date: June 4, 2018  
Individual/Entity: **Thrift Brothers Lumber Co., Inc.**  
Facility: Thrift Brothers Lumber Co., Inc.  
Location: 111 Toccoa Highway  
Westminster, SC 29693  
Mailing Address: P.O. Box 349  
Westminster, SC 29693-0349  
County: Oconee  
Previous Orders: None  
Permit/ID Number: 06676  
Violations Cited: The State Underground Petroleum Environmental Response Bank Act of 1988 (SUPERB Act), S.C. code Ann. § 44-2-60(A) (2002 and Supp. 2016); and South Carolina Underground Storage Tank Control Regulation, 7 S.C. Code Ann. Regs. 61-92.280.93(a), and 280.110(c) (2017).

Summary: Thrift Brothers Lumber Co., Inc. (Individual/Entity), owns and operates underground storage tanks located in Westminster, South Carolina. On August 30, 2017, the Department issued a Notice of Alleged Violation because the annual tank registration fees for fiscal year 2018 had not been paid. On September 1, 2017, the Department issued a Notice of Alleged Violation because there was no current financial responsibility documentation on file. The Individual/Entity has violated the SUPERB Act and the South Carolina Underground Storage Tank Regulation, as follows: failed to pay annual underground storage tank registration fees, failed to demonstrate financial responsibility for an UST system, and failed to submit evidence of financial assurance to the Department upon request.

Action: The Individual/Entity is required to: submit a completed Certificate of Financial Responsibility form and provide evidence of financial assurance, pay annual underground storage tank registration fees and associated late fees in the amount of one thousand, two hundred ten dollars (\$1,210.00), and pay a civil penalty in the amount of five thousand, fifty dollars (**\$5,050.00**).

4) Order Type and Number: Administrative Order 17-0460-UST  
Order Date: June 4, 2018  
Individual/Entity: **Timothy R. West**  
Facility: Former Dean's Service Center  
Location: 1220 North Fifth Street  
Hartsville, SC 29551  
Mailing Address: 1009 Pineneedle Road  
Hartsville, SC 29551  
County: Darlington  
Previous Orders: None  
Permit/ID Number: 02789  
Violations Cited: The State Underground Petroleum Environmental Response Bank Act of 1988 (SUPERB Act), S.C. code Ann. § 44-2-60(A) (2002 and Supp. 2016); and South Carolina Underground Storage Tank Control Regulation, 7 S.C. Code Ann. Regs. 61-92.280.70(c), 280.93(a), and 280.110(c) (2017).

Summary: Timothy R. West (Individual/Entity), owns underground storage tanks located in Hartsville, South Carolina. On October 9, 2017, the Department issued a Notice of Alleged Violation/Notice of Enforcement Conference because the USTs had been temporarily out of service for more than twelve (12) months and did not meet corrosion protection standards; no current financial responsibility documentation was on file; and the annual tank registration fees for fiscal years 2015 through 2018 had not been paid. The Individual/Entity has violated the SUPERB Act and the South Carolina Underground Storage Tank Regulation, as follows: failed to pay annual underground storage tank registration fees, failed to permanently close USTs that have been temporarily out of service for greater than twelve (12) months and do not meet current corrosion protection standards, failed to demonstrate financial responsibility for an UST system, and failed to submit evidence of financial assurance to the Department upon request.

Action: The Individual/Entity is required to: submit a completed Tank/Sludge Disposal form; permanently close the USTs and submit an UST Closure and Assessment Report, submit a completed Certificate of Financial Responsibility form and provide evidence of financial assurance if contamination found, pay annual underground storage tank registration fees and associated late fees in the amount of eleven thousand, four hundred ninety-five dollars (\$11,495.00), and pay a civil penalty in the amount of thirty-four thousand, two hundred twenty-five dollars (**\$34,225.00**).

5) Order Type and Number: Administrative Order 17-0140-UST  
Order Date: June 6, 2018  
Individual/Entity: **Joaquim Morais**  
Facility: Amy's Grill  
Location: 12132 North Highway 905  
Longs, SC 29718  
Mailing Address: P.O. Box 141  
Jefferson, SC 29568  
County: Horry  
Previous Orders: AO 16-0018-UST (\$9,800.00)  
Permit/ID Number: 13066  
Violations Cited: The State Underground Petroleum Environmental  
Response Bank Act of 1988 (SUPERB Act), S.C. code Ann. § 44-2-60(A) (2002 and Supp. 2016).

Summary: Joaquim Morais (Individual/Entity) owns underground storage tanks located in Longs, South Carolina. On May 1, 2017, the Department issued a Notice of Alleged Violation because the annual tank registration fees for fiscal year 2017 had not been paid. On August 4, 2017, the Department issued Notice of Alleged Violation because the annual tank registration fees for fiscal year 2018 had not been paid. The Individual/Entity has violated the SUPERB Act and South Carolina Underground Storage Tank Regulation, as follows: failed to pay annual underground storage tank registration fees.

Action: The Individual/Entity is required to: pay annual underground storage tank registration fees and associated late fees in the amount of two thousand, four hundred twenty dollars (\$2,420.00), and pay a civil penalty in the amount of three thousand, six hundred dollars (**\$3,600.00**).

6) Order Type and Number: Administrative Order 18-0089-UST  
Order Date: June 6, 2018  
Individual/Entity: **Albert Rollings**  
Facility: City Service  
Location: 204 South Main Street  
Jefferson, SC 29718  
Mailing Address: P.O. Box 141  
Jefferson, SC 29718  
County: Chesterfield  
Previous Orders: AO 14-0286-UST (\$2,550.00)  
Permit/ID Number: 02300  
Violations Cited: The State Underground Petroleum Environmental  
Response Bank Act of 1988 (SUPERB Act), S.C. code Ann. § 44-2-60(A) (2002 and Supp. 2016);  
and South Carolina Underground Storage Tank Control Regulation, 7 S.C. Code Ann. Regs. 61-  
92.280.70(c), 280.93(a), and 280.110(c) (2017).

Summary: Albert Rollings (Individual/Entity) owns underground storage tanks located in Jefferson, South Carolina. On December 28, 2017, the Department issued a Notice of Alleged Violation because the USTs had been temporarily out of service for more than twelve (12) months and did not meet corrosion protection standards; no current financial responsibility documentation was on file; and annual tank registration fees for fiscal years 2016, 2017, and 2018 had not been paid. The Individual/Entity has violated the SUPERB Act and the South Carolina Underground Storage Tank Regulation, as follows: failed to pay annual underground storage tank registration fees, failed to permanently close USTs that have been temporarily out of service for greater than twelve (12) months and do not meet current corrosion protection standards, failed to demonstrate financial responsibility for an UST system, and failed to submit evidence of financial assurance to the Department upon request.

Action: The Individual/Entity is required to: submit a completed Tank/Sludge Disposal form; permanently close the USTs and submit an UST Closure and Assessment Report, submit a completed Certificate of Financial Responsibility form and provide evidence of financial assurance if contamination found, pay annual underground storage tank registration fees and associated late fees in the amount of three thousand, six hundred thirty dollars (\$3,630.00), and pay a civil penalty in the amount of nineteen thousand, eight hundred fifty dollars (**\$19,850.00**).

7) Order Type and Number: Administrative Order 17-0369-UST  
Order Date: June 25, 2018  
Individual/Entity: **Robert M. Youmans, II**  
Facility: RMY, Inc.  
Location: 1890 Main Street North  
Allendale, SC 29810  
Mailing Address: 40 Northview Drive  
Beaufort, SC 29906  
County: Allendale  
Previous Orders: None  
Permit/ID Number: 00329  
Violations Cited: The State Underground Petroleum Environmental Response Bank Act of 1988 (SUPERB Act), S.C. code Ann. § 44-2-60(A) (2002 and Supp. 2016); and South Carolina Underground Storage Tank Control Regulation, 7 S.C. Code Ann. Regs. 61-92.280.70(c) (2017).

Summary: Robert M. Youmans, II (Individual/Entity), owns underground storage tanks located in Allendale, South Carolina. On August 3, 2016, the Department issued a Notice of Alleged Violation/Notice of Enforcement Conference because the USTs had been temporarily out of service for more than twelve (12) months and did not meet corrosion protection standards; and annual underground storage registration fees for fiscal years 2016 and 2017 had not been paid. On September 1, 2017, the Department issued a Notice of Alleged Violation/Notice of Enforcement Conference because the annual underground storage tank registration fees for fiscal year 2018 had not been paid. The Individual/Entity has violated the SUPERB Act and the South Carolina Underground Storage Tank Regulation, as follows: failed to pay annual underground storage tank registration fees and failed to permanently close USTs that have been temporarily out of service for greater than twelve (12) months and do not meet current corrosion protection standards.

Action: The Individual/Entity is required to: submit a completed Tank/Sludge Disposal form; permanently close the USTs and submit an UST Closure and Assessment Report, pay annual underground storage tank registration fees and associated late fees in the amount of five thousand, two hundred eighty dollars (\$5,280.00), and pay a civil penalty in the amount of sixteen thousand, one hundred twenty-five dollars (**\$16,125.00**).

8) Order Type and Number: Administrative Order 17-0464-UST  
Order Date: June 25, 2018  
Individual/Entity: **Rodney Graham**  
Facility: Pit Stop  
Location: 1209 Highway 501  
Conway, SC 29526-8320  
Mailing Address: P.O. Box 973  
Conway, SC 29526  
County: Horry  
Previous Orders: None

Permit/ID Number: 14427  
Violations Cited: The State Underground Petroleum Environmental Response Bank Act of 1988 (SUPERB Act), S.C. code Ann. § 44-2-60(A) (2002 and Supp. 2016); and South Carolina Underground Storage Tank Control Regulation, 7 S.C. Code Ann. Regs. 61-92.280.70(c), 280.93(a), and 280.110(c) (2017).

Summary: Rodney Graham (Individual/Entity), owns and operates underground storage tanks located in Conway, South Carolina. On October 9, 2017, the Department issued a Notice of Alleged Violation/Notice of Enforcement Conference because the USTs had been temporarily out of service for more than twelve (12) months and did not meet corrosion protection standards; there was no current financial responsibility documentation on file; and, annual underground storage tank registration fees for fiscal year 2013 through 2018 had not been paid. The Individual/Entity has violated the SUPERB Act and the South Carolina Underground Storage Tank Regulation, as follows: failed to pay annual underground storage tank registration fees, failed to permanently close USTs that have been temporarily out of service for greater than twelve (12) months and do not meet current corrosion protection standards, failed to demonstrate financial responsibility for an UST system, and failed to submit evidence of financial assurance to the Department upon request.

Action: The Individual/Entity is required to: submit a completed Tank/Sludge Disposal form; permanently close the USTs and submit an UST Closure and Assessment Report, submit a completed Certificate of Financial Responsibility form and provide evidence of financial assurance if contamination found, pay annual underground storage tank registration fees and associated late fees in the amount of eleven thousand, six hundred sixteen dollars (\$11,616.00), and pay a civil penalty in the amount of forty one thousand, two hundred fifty dollars (**\$41,250.00**).

9) Order Type and Number: Administrative Order 17-0358-UST  
Order Date: July 17, 2018  
Individual/Entity: **Frank McGuire, Jr.**  
Facility: Express Mart  
Location: 1025 Pole Branch Road  
Clover, SC 29710-6001  
Mailing Address: P.O. Box 37599  
Rock Hill, SC 29732  
County: York  
Previous Orders: AO 15-0076-UST (\$2,650.00)  
AO 16-0284-UST (\$10,600.00)  
Permit/ID Number: 17835  
Violations Cited: The State Underground Petroleum Environmental Response Bank Act of 1988 (SUPERB Act), S.C. code Ann. § 44-2-60(A) (2002 and Supp. 2016).

Summary: Frank McGuire, Jr. (Individual/Entity) owns underground storage tanks located in Clover, South Carolina. On August 4, 2017, the Department issued a Notice of Alleged Violation the annual underground storage tank registration fees for fiscal year 2018 had not been paid. The Individual/Entity has violated the SUPERB Act as follows: failed to pay annual underground storage tank registration fees.

Action: The Individual/Entity is required to: pay annual underground storage tank registration fees in the amount of six hundred five dollars (\$605.00) and pay a civil penalty in the amount of nine hundred dollars (**\$900.00**).

- 10) Order Type and Number: Administrative Order 17-0410-UST  
Order Date: August 8, 2018  
Individual/Entity: **Shiv One LLC**  
Facility: Coosawhatchie General Store  
Location: 6282 West Frontage Road  
Coosawhatchie, SC 29936  
Mailing Address: Same  
County: Jasper  
Previous Orders: CO 16-0178-UST (\$1,200.00)  
Permit/ID Number: 10422  
Violations Cited: The State Underground Petroleum Environmental Response Bank Act of 1988 (SUPERB Act), S.C. code Ann. § 44-2-10 (2002 and Supp. 2016); and South Carolina Underground Storage Tank Control Regulation, 7 S.C. Code Ann. Regs. 61-92.280.93(a), and 280.110(c) (2017).

Summary: Shiv One LLC (Individual/Entity), owns and operates underground storage tanks located in Coosawhatchie, South Carolina. On August 16, 2017, the Department issued a Notice of Alleged Violation, because there was no financial responsibility on file with the Department. The Individual/Entity has violated the SUPERB Act and the South Carolina Underground Storage Tank Regulation, as follows: failed to demonstrate financial responsibility for an UST system, and failed to submit evidence of financial assurance to the Department upon request.

Action: The Individual/Entity is required to: submit a completed Certificate of Financial Responsibility form and submit evidence of financial assurance and pay a civil penalty in the amount of four thousand, seven hundred fifty dollars **(\$4,750.00)**.

- 11) Order Type and Number: Administrative Order 17-0033-UST  
Order Date: August 15, 2018  
Individual/Entity: **Joseph T. Hardee**  
Facility: Hardee's Grocery  
Location: 535 Main Street  
Gilbert, SC 29054  
Mailing Address: 537 Main Street  
Gilbert, SC 29054  
County: Lexington  
Previous Orders: AO15-0371-UST (\$600.00)  
AO16-0106-UST (\$2,500.00)  
Permit/ID Number: 14755  
Violations Cited: The State Underground Petroleum Environmental Response Bank Act of 1988 (SUPERB Act), S.C. code Ann. § 44-2-60(A) (2002 and Supp. 2016); and South Carolina Underground Storage Tank Control Regulation, 7 S.C. Code Ann. Regs. 61-92.280.70(c), 280.93(a), and 280.110(c) (2017).

Summary: Joseph T. Hardee (Individual/Entity), owned and operated underground storage tanks located in Gilbert, South Carolina. On June 14, 2018, the Department issued a Notice of Alleged Violation/Notice of Enforcement Conference because the Department had not received an UST Closure and Assessment Report, there was no current financial responsibility documentation on file, and annual underground storage tank registration fees for fiscal years 2016 and 2017 had not been paid. On June 20, 2018, Department Personnel were present for an enforcement conference; however, the Individual/Entity did not attend. The Individual/Entity has violated the SUPERB Act and the South Carolina Underground Storage Tank Regulation, as follows: failed to pay annual underground storage tank registration fees, failed to notify the Department prior to permanent tank closure and failed to submit an UST Closure

Assessment Report, failed to demonstrate financial responsibility for an UST system, and failed to submit evidence of financial assurance to the Department upon request.

Action: The Individual/Entity is required to: submit an UST Closure and Assessment Report, submit a completed Certificate of Financial Responsibility form and provide evidence of financial assurance if contamination is found, pay annual underground storage tank registration fees and associated late fees in the amount of three thousand, six hundred thirty dollars (\$3,630.00), and pay a civil penalty in the amount of forty-seven thousand, six hundred dollars **(\$47,600.00)**.

12) Order Type and Number: Administrative Order 17-0138-UST  
Order Date: August 20, 2018  
Individual/Entity: **Nixon Robert Small**  
Facility: Former Union School Bus Shop  
Location: 1734 Jonesville Highway  
Union, SC 29379  
Mailing Address: 453 West Hillcrest Avenue  
Union, SC 29379  
County: Union  
Previous Orders: None  
Permit/ID Number: 08951  
Violations Cited: The State Underground Petroleum Environmental Response Bank Act of 1988 (SUPERB Act), S.C. code Ann. § 44-2-10 (2002 and Supp. 2016); and South Carolina Underground Storage Tank Control Regulation, 7 S.C. Code Ann. Regs. 61-92.280.71(a), 280.72(a) and (c), 280.93(a), and 280.110(c) (2017).

Summary: Nixon Robert Small (Individual/Entity), owned an underground storage tank located in Union, South Carolina. On July 11, 2018, the Department issued a Notice of Alleged Violation/Notice of Enforcement Conference because the Department had not received an UST Closure and Assessment Report and there was no current financial responsibility documentation on file. On July 26, 2018, Department Personnel were present for an enforcement conference; however, the Individual/Entity did not attend. The Individual/Entity has violated the SUPERB Act and the South Carolina Underground Storage Tank Regulation, as follows: failed to notify the Department prior to permanent tank closure and failed to submit an UST Closure and Assessment Report, failed to demonstrate financial responsibility for an UST system, and failed to submit evidence of financial assurance to the Department upon request.

Action: The Individual/Entity is required to: submit an UST Closure and Assessment Report, submit a completed Certificate of Financial Responsibility form and provide evidence of financial assurance if contamination is found, and pay a civil penalty in the amount of six thousand, six hundred dollars **(\$6,600.00)**.

13) Order Type and Number: Administrative Order 17-0159-UST  
Order Date: August 22, 2018  
Individual/Entity: **Situ, LLC**  
Facility: Cruizers 15 and Cruizers 5  
Location: 1000 E. Liberty St. and 1504 S. Main St.  
Marion, SC and Darlington, SC  
Mailing Address: 3352 Thornblade Drive  
Florence, SC 29501  
County: Marion and Darlington  
Previous Orders: None  
Permit/ID Number: 18713 and 18729



Violations Cited: The State Underground Petroleum Environmental Response Bank Act of 1988 (SUPERB Act), S.C. code Ann. § 44-2-10 (2002 and Supp. 2016); and South Carolina Underground Storage Tank Control Regulation, 7 S.C. Code Ann. Regs. 61-92.280.65 (2017).

Summary: Situ, LLC (Individual/Entity), owns and operates underground storage tanks located in Marion and Darlington, South Carolina. On January 23, 2017, the Department issued a Notice of Alleged Violation because a Site-Specific Work Plan (SSWP) for an Initial Groundwater Assessment (IGWA) Cruizers 15 had not been submitted to the Department. On June 19, 2017, the Department issued a Notice of Alleged Violation because a SSWP for an IGWA at Cruizers 5 had not been submitted to the Department. On October 3, 2017, the Department issued a proposed Consent Order for SSWPs for an IGWA at both Facilities. The Individual/Entity did not submit the SSWPs and did not sign the Consent Order. The Individual/Entity has violated the SUPERB Act and the South Carolina Underground Storage Tank Regulation, as follows: failed to determine the full extent of a release in accordance with a schedule established by the Department.

Action: The Individual/Entity is required to: submit a SSWP for an IGWA at Cruizers 15; submit a SSWP for an IGWA at Cruizers 5; pay a civil penalty in the amount of six thousand dollars (**\$6,000.00**) and pay a stipulated penalty of six thousand, four hundred dollars (\$6,400.00) should any requirement of the Order not be met.

14) Order Type and Number: Consent Order 18-0126-UST  
Order Date: June 29, 2018  
Individual/Entity: **Speedway LLC**  
Facility: Speedway 4571  
Location: 2798 East Main Street  
Spartanburg, SC 29009  
Mailing Address: 500 Speedway Drive  
Enon, OH 45323-1056  
County: Spartanburg  
Previous Orders: None  
Permit/ID Number: 17493  
Violations Cited: The State Underground Petroleum Environmental Response Bank Act of 1988 (SUPERB Act), S.C. code Ann. § 44-2-10 (2002 and Supp. 2014); and South Carolina Underground Storage Tank Control Regulation, 7 S.C. Code Ann. Regs. 61-92.280.20(c)(1)(ii) (2017).

Summary: Speedway LLC (Individual/Entity) owns and operates underground storage tank located in Spartanburg, South Carolina. On May 3, 2018, the Department conducted a routine inspection and issued a Notice of Alleged Violation because there was no drop tube shutoff valve present on the premium UST. On May 16, 2018, the Department received proof that a drop tube shutoff valve had been installed on the premium UST. The Individual/Entity has violated the SUPERB Act and the South Carolina Underground Storage Tank Regulation, as follows: failed to maintain overfill prevention equipment on an underground storage tank system.

Action: The Individual/Entity is required to: pay a civil penalty in the amount of one thousand dollars (**\$1,000.00**).

- 15) Order Type and Number: Consent Order 18-0134-UST  
Order Date: July 18, 2018  
Individual/Entity: **Enmark Stations, Inc.**  
Facility: Enmark 890  
Location: 8933 Old Number 6 Highway  
Santee, SC, 29142  
Mailing Address: P.O. Box 728  
Savannah, GA, 31402-0728  
County: Orangeburg  
Previous Orders: None  
Permit/ID Number: 11756  
Violations Cited: The State Underground Petroleum Environmental Response Bank Act of 1988 (SUPERB Act), S.C. code Ann. § 44-2-10 (2002 and Supp. 2016) and South Carolina Underground Storage Tank Control Regulation, 7 S.C. Code Ann. Regs. 61-92.280.20(c)(1)(ii) (2017).

Summary: Enmark Stations, Inc. (Individual/Entity), owns and operates underground storage tanks located in Santee, South Carolina. On May 29, 2018, the Department conducted a routine inspection and issued a Notice of Alleged Violation because there was a stick in the drop tube shutoff valve on tank number 2. The stick was removed from the drop tube. The Individual/Entity has violated the State Underground Petroleum Environmental Response Bank Act of 1988 and the South Carolina Underground Storage Tank Control Regulation as follows: failed to maintain overfill prevention equipment on an UST system.

Action: The Individual/Entity is required to pay a civil penalty in the amount of one thousand dollars (**\$1,000.00**).

- 16) Order Type and Number: Consent Order 18-0135-UST  
Order Date: July 18, 2018  
Individual/Entity: **Spinx Company, Inc.**  
Facility: Spinx 364  
Location: 845 Jedburg Road  
Summerville, SC 29486  
Mailing Address: P.O. Box 8624  
Greenville, SC 29604  
County: Dorchester  
Previous Orders: None  
Permit/ID Number: 19879  
Violations Cited: The State Underground Petroleum Environmental Response Bank Act of 1988 (SUPERB Act), S.C. code Ann. § 44-2-10 (2002 and Supp. 2014); and South Carolina Underground Storage Tank Control Regulation, 7 S.C. Code Ann. Regs. 61-92.280.20(c)(1)(ii) (2017).

Summary: Spinx Company, Inc. (Individual/Entity), located in Greenville, South Carolina, owns and operates underground storage tanks located in Summerville, South Carolina. On May 25, 2018, the Department conducted a routine inspection and issued a Notice of Alleged Violation because there was a stick in the drop tube shutoff valve on the regular unleaded tank. The stick was removed while Department's Inspector was on site. The Individual/Entity has violated the SUPERB Act and South Carolina Underground Storage Tank Regulation, as follows: failed to maintain overfill prevention equipment on an underground storage tank system.

Action: The Individual/Entity is required to: pay a civil penalty in the amount of one thousand dollars (**\$1,000.00**).

### **Solid Waste Enforcement**

17) Order Type and Number: Administrative Order 18-12-SW  
Order Date: May 31, 2018  
Individual/Entity: **Jake Marcengill**  
Facility: Spring Valley Recycling  
Location: 1151 Carrandine Road  
Seneca, SC 29678  
Mailing Address: 1028 Friendship Road  
Seneca, SC 29678  
County: Oconee  
Previous Orders: None  
Permit/ID Number: N/A  
Violations Cited: South Carolina Solid Waste Policy and Management Act of 1991 (Act) (2002), S.C. Code Ann., 44-96-10 et seq. (2002 & Supp. 2016) and Solid Waste Management: Waste Tire Regulation 61-107.3 (2015)

Summary: Jake Marcengill (Individual/Entity), operated Spring Valley Recycling located in Seneca South Carolina. On March 2, 2017, March 23, 2017, June 7, 2017, July 21, 2017, February 26, 2018, and April 18, 2018, the Department conducted inspections. The Individual/Entity has violated the South Carolina Solid Waste Policy and Management Act and Solid Waste Management: Waste Tire Regulation as follows operated a waste tire collection facility without a permit from the Department, in that greater than one hundred twenty (120) waste tires were stored at the Facility.

Action: The Individual/Entity is required to: remove and dispose of all waste tires at the facility and provide the Department with disposal receipts; and, pay a civil penalty in the amount of five thousand nine hundred thirty-seven dollars fifty cents (**\$5,937.50**).

18) Order Type and Number: Consent Order 18-11-SW  
Order Date: June 13, 2018  
Individual/Entity: **Derek Brown and Shandel C. Brown**  
Facility: Private Property, TMS #3-10-00-045.00  
Location: 4520 Cannons Campground Road  
Spartanburg, SC  
Mailing Address: P.O. Box 1226  
Cowpens, SC 29330  
County: Spartanburg  
Previous Orders: None  
Permit/ID Number: N/A  
Violations Cited: South Carolina Solid Waste Policy and Management Act of 1991 (Act), and Solid Waste Management: Solid Waste Landfills and Structural Fill Regulation 61-107.19 (Regulation).

Summary: Derek Brown and Shandel C. Brown (Individual/Entity), located in Spartanburg, South Carolina, are responsible for operating a structural fill without a permit. The Department conducted an inspection on November 20, 2017 and determined that the Site had been filled without a structural fill permit from the Department. The Individual/Entity has violated the South Carolina Solid Waste Policy and

Management Act and the Solid Waste Management: Solid Waste Landfills and Structural Fill Regulation as follows: failed to receive written approval from the Department to operate under the Permit-by-rule for a specific site, prior to engaging in structural fill activity.

Action: The Individual/Entity is required to: complete closure activities of the Site; record notation of deed; pay a civil penalty in the amount of five hundred dollars (**\$500.00**); and, pay a stipulated penalty in the amount of three thousand dollars (\$3,000.00) should any requirement of the Order not be met.

- 19) Order Type and Number: Consent Order 18-07-SW  
Order Date: June 26, 2018  
Individual/Entity: **New Century Construction Company, LLC**  
Facility: New Century Construction Class 1 Landfill  
Location: 1437 Davis Mill Road  
Seneca, SC  
Mailing Address: 100 War Woman Trail  
Seneca, SC 29672  
County: Oconee  
Previous Orders: None  
Permit/ID Number: 372649-1701  
Violations Cited: South Carolina Solid Waste Policy and Management Act of 1991 (Act), Solid Waste Management: Solid Waste Landfills and Structural Fill Regulation 61-107. (Regulation) and Permit 372649-1701.

Summary: New Century Construction Company, LLC (Individual/Entity), located in Seneca, South Carolina, owns and operates a Class 1 landfill. The Department conducted inspections on February 22, 2017, May 26, 2017, July 12, 2017, and November 1, 2017. The Individual/Entity has violated the South Carolina Solid Waste Policy and Management Act and the Solid Waste Management: Solid Waste Landfills and Structural Fill Regulation as follows: failed to have the one hundred (100) foot buffer from any property line; failed to restrict, to the working face of the landfill, the unloading of solid waste intended for disposal in the landfill; failed to confine the working face to as small an area as the equipment can safely and efficiently operate; failed to spread waste in uniform layers; failed to place, at least quarterly, a uniform layer of clean soil no less than six (6) inches in depth over all exposed waste material; failed to clearly mark the waste disposal boundary prior to the disposal of waste by placing permanent markings every three-hundred (300) feet around the boundary; and failed to keep a daily log of waste disposed of at the landfill.

Action: The Individual/Entity is required to: have the property line surveyed and clearly marked and obtain a waiver from the adjacent property owner, if necessary; clearly mark the waste disposal boundaries; ensure that no waste piles are outside of the working face area; ensure the waste is spread in uniform layers; ensure that there is adequate cover on both active and inactive areas, and slopes are 3:1; complete the differentiation of daily logs for the wood grinding operation, landfill, and, recovered material processing; pay a civil penalty in the amount of three thousand, five hundred dollars (**\$3,500.00**) and, pay a stipulated penalty in the amount of ten thousand dollars (\$10,000.00) should any requirement of the Order not be met.

- 20) Order Type and Number: Consent Order 18-14-SW  
Order Date: August 2, 2018  
Individual/Entity: **378 Recycle Center, LLC**  
Facility: 378 Recycle Center Wood Processing  
Location: 4520 Cannons Campground Road  
Lexington, South Carolina

Mailing Address: 5009 Sunset Blvd.  
Lexington, South Carolina 29072  
County: Lexington  
Previous Orders: 16-23-SW (\$4,400.00)  
Permit/ID Number: 322456-3002  
Violations Cited: South Carolina Solid Waste Policy and Management Act of 1991, 15A S.C. Code Ann. Laws, § 44-96-10 et seq. (2002 & Supp. 2016) (Act) and Solid Waste Management: Solid Waste Landfills and Structural Fill, 8 S.C. Code Ann. Regs., R. 61-107.19 (2016) (Regulation).

Summary: 378 Recycle Center, LLC (Individual/Entity), located in Lexington, South Carolina, is responsible for operating a wood processing facility. The Department conducted inspections on January 26, 2018, and March 12, 2018, and determined that the amount of unprocessed feedstock at the Facility exceeded the permitted allowance of 1,425 cubic yards. The Individual/Entity has violated the South Carolina Solid Waste Policy and Management Act and the Solid Waste Management: Solid Waste Landfills and Structural Fill Regulation as follows: exceeded the maximum capacity of feedstock and other materials allowed by the permit.

Action: The Individual/Entity is required to: cease accepting deliveries of any feedstocks or other materials for processing until the storage of unprocessed feedstocks or other materials is less than 1,425 cubic yards; and, pay a civil penalty in the amount of seven thousand, five hundred dollars **(\$7,500.00)**

21) Order Type and Number: Consent Order 18-05-SW  
Order Date: August 20, 2018  
Individual/Entity: **H. S. Willis, Jr.**  
Facility: H.S. Willis, Jr. Residence  
Location: 220 Barway Drive  
Aiken, SC 29083  
Mailing Address: Same  
County: Aiken  
Previous Orders: None  
Permit/ID Number: N/A  
Violations Cited: South Carolina Solid Waste Policy and Management Act of 1991, 15A S.C. Code Ann. Laws, § 44-96-10 et seq. (2002 & Supp. 2016) (Act) and Solid Waste Management: Waste Tires, 8 S.C. Code Ann. Regs., R. 61-107.3 (2015); Part III.A.1.

Summary: Mr. H.S. Willis, Jr. (Individual/Entity), located in Aiken, South Carolina, has approximately two hundred fifty (250) waste tires stored on his property. On October 24, 2017, December 21, 2017, March 6, 2018, and June 26, 2018, the Department conducted inspections. The Individual/Entity has violated the South Carolina Solid Waste Policy and Management Act and the Solid Waste Management: Waste Tire Regulation as follows: stored greater than one hundred twenty (120) waste tires at the Site without first obtaining a permit from the Department to operate a waste tire collection facility.

Action: The Individual/Entity is required to: dispose of the waste tires at a facility permitted by the Department to accept waste tires; provide disposal receipts to the Department; and pay a **stipulated civil penalty** in the amount of four thousand, three hundred seventy-five dollars **(\$4,375.00)** should any of the requirements of the Order not be met.

## Hazardous Waste Enforcement

- 22) Order Type and Number: Consent Order 18-13-HW  
Order Date: June 6, 2018  
Individual/Entity: **Hentzen Coatings, Inc.**  
Facility: Hentzen Coatings, Inc.  
Location: 307 Echelon Road  
Greenville, SC 29605  
Mailing Address: 5182 12~~th~~ Avenue North  
Clearwater, FL 33760  
County: Greenville  
Previous Orders: None  
Permit/ID Number: SCR 000 766 345  
Violations Cited: The South Carolina Hazardous Waste Management Act, S.C. Code Ann. §44-56-10 et seq (2002 and Supp. 2016), and the South Carolina Hazardous Waste Management Regulation, 6 and 7 S.C. Code Ann. Regs. 61-79 (2012 and Supp. 2016).

Summary: Hentzen Coatings, Inc. (Individual/Entity) specializes in aerospace coatings at its facility located in Greenville, South Carolina. The Department conducted an inspection on November 9, 2017. The Individual/Entity violated the South Carolina Hazardous Waste Management Act and the South Carolina Hazardous Waste Management Regulations as follows: failed to have solvent-contaminated wipes, when accumulated, stored, and transported, contained in non-leaking, closed containers that are labeled "Excluded Solvent-Contaminated Wipes;" failed to maintain the required solvent-contaminated wipe documentation at the facility; failed to ensure while being accumulated onsite, each container is labeled marked clearly with the EPA Hazardous Waste Number and the words: "Hazardous Waste - federal laws prohibit improper disposal;" failed to accurately determine if that waste was a hazardous waste; failed to keep containers holding hazardous waste closed, except when it is necessary to add or remove waste; failed to include the name of the individual conducting the hazardous waste weekly inspections in the inspection log; failed to clean up a hazardous waste discharge that occurred during processing; failed to maintain lamps in a manner to prevent a release and to keep such containers closed; failed to label or mark clearly each container of universal lamps; and, failed to demonstrate the length of time universal waste had been accumulated from the date it became a waste.

Action: The Individual/Entity is required to: pay a civil penalty in the amount of nine thousand, five hundred dollars (**\$9,500.00**).

- 23) Order Type and Number: Consent Order 18-16-HW  
Order Date: June 29, 2018  
Individual/Entity: **Edwards Auto Sales Co, Inc.**  
Facility: Edwards Auto Sales  
Location: 3440 Blue Ridge Blvd.  
Walhalla, SC 29691  
Mailing Address: P.O. Box 709  
Walhalla, SC 29691  
County: Oconee  
Previous Orders: None  
Permit/ID Number: SCR 036 282 903  
Violations Cited: The South Carolina Hazardous Waste Management Act S.C. Code Ann. §44-56-10 et seq (2002 and Supp. 2016); The South Carolina Hazardous Waste Management Regulations, 6 and 7 S.C. Code Ann. Regs (2012 and Supp. 2016); South Carolina Solid Waste Policy and Management Act of 1991 (Act), 15A S.C. Code Ann. Laws, §44-06-10

seq(2002 & Supp. 2016); and The Solid Waste Management: Used Oil, 8 S.C. Code Ann. Regs. 61-107.279 (2012)

Summary: Edwards Auto Sales Co, Inc. (Individual/Entity) operates an automobile sales and maintenance facility in Walhalla, South Carolina. On January 4, 2018, the Department conducted an inspection at the facility. The Individual/Entity violated the South Carolina Hazardous Waste Management Act, Hazardous Waste Management Regulations and Used Oil Regulation as follows: failed to remove, within three days, excess waste in a satellite accumulation area; failed to post the following information next to the telephone: location of fire extinguishers and spill control equipment, and if present, fire alarm; failed to ensure that all employees are thoroughly familiar with proper waste handling and emergency procedures relevant to their responsibilities during normal facility operations and emergencies; failed to contain any lamp in containers or packages that are structurally sound, adequate to prevent breakage, and compatible with the contents of the lamps; failed to label or mark clearly each lamp or container or package in which such lamps are contained with one of the following phrases: "Universal Waste - Lamp(s)," or "Waste Lamp(s)," or "Used Lamp(s);" failed to demonstrate the length of time that the universal waste has been accumulated from the date it becomes a waste or is received; failed to ensure that containers and above ground tanks used to store used oil at generator facilities are closed to prevent spillage or contamination from precipitation; and failed to ensure that containers and above ground tanks used to store used oil at generator facilities are labeled or marked clearly with the words "Used Oil."

Action: The Individual/Entity has agreed to pay a civil penalty in the amount of two thousand dollars (**\$2,000.00**).

24) Order Type and Number: Consent Order 18-17-HW  
Order Date: August 20, 2018  
Individual/Entity: **FN America, LLC**  
Facility: FN America  
Location: 797 Old Clemson Road  
Columbia, SC 29229  
Mailing Address: Same  
County: Richland  
Previous Orders: N/A  
Permit/ID Number: SCR 991 279 399  
Violations Cited: The South Carolina Hazardous Waste Management Act, S.C. Code Ann. §44-56-10 et seq(2002 and Supp. 2016); the South Carolina Hazardous Waste Management Regulation, 6 and 7 S.C. Code Ann. Regs. 61-79 (2012 and Supp. 2016); the South Carolina Hazardous Waste Regulations, 6 and 7 S.C. Code Ann. Regs. 61-79 (2012 and Supp. 2016); and the Solid Waste Management: Used Oil, 8 S.C. Code Ann. Regs., R. 61-107.279 (2012)

Summary: FN America, LLC (Individual/Entity) manufactures firearms at its facility located at 797 Old Clemson Rd, Columbia, South Carolina. On November 30, 2017, representatives of the Department and the United States Environmental Protection Agency (EPA) conducted an inspection at the facility. The Individual/Entity violated the South Carolina Hazardous Waste Management Act and the Hazardous Waste Management Regulations as follows: failed to keep a container holding hazardous waste closed during storage, except when it is necessary to add or remove waste; failed to manage a container holding hazardous waste so that it must not be opened, handled, or stored in a manner which may rupture the container or cause it to leak; failed to mark each container containing hazardous waste permanently and legibly with the following "Hazardous waste - federal laws prohibit improper disposal;" failed to clearly mark each container with the date each period of accumulation begins; failed to mark each satellite accumulation container with the words "HAZARDOUS WASTE" or other words that identify the contents of the container; failed to clean up any hazardous waste discharge that occurs during generation or processing or storage; and take such other action as may be required or approved by Federal, State or local officials so that the

hazardous waste discharge no longer presents a hazard to human health or the environment; failed to label or mark clearly each lamp or container or package in which such lamps are contained with one of the following phrases: "Universal Waste - Lamp(s)," or "Waste Lamp(s)," or "Used Lamp(s);" failed to accumulate universal waste no longer than one year from the date the universal waste is generated, or received from another handler; failed to demonstrate the length of time that the universal waste has been accumulated from the date it becomes a waste or is received; and, failed to ensure that containers and above ground tanks used to store used oil at generator facilities are labeled or marked clearly with the words "Used Oil."

Action: The Individual/Entity is required to: pay a civil penalty of five thousand, two hundred and fifty dollars (**\$5,250.00**).

### **Infectious Waste Enforcement**

25) Order Type and Number: Consent Order 18-11-IW  
Order Date: June 26, 2018  
Individual/Entity: **Palmetto Primary Care Physicians**  
Facility: Palmetto Primary Care Physicians  
Location: 87 Springview Lane  
Summerville, SC  
Mailing Address: 1101 Trolley Road, Suite 100  
Summerville, SC 29485  
County: Dorchester  
Previous Orders: None  
Permit/ID Number: SC25-0035G  
Violations Cited: The South Carolina Infectious Waste Management Act S.C. Code Ann. §44-93-10et seq(Rev. 2002 and Supp. 2016); The South Carolina Infectious Waste Management Regulations, 8 S.C. Code Ann. Regs. 61-30.D(1) and R.61-30.G(12)(b) (2012)

Summary: Palmetto Primary Care Physicians (Individual/Entity) operates a medical facility Summerville, South Carolina. On July 24, 2017, the Department mailed an invoice for infectious waste generator registration fees for July 1,2017 through July 1, 2018. Subsequent invoices including penalties were mailed on August 31, 2017, October 16, 2017, and October 24, 2017. The Individual/Entity has violated the South Carolina Infectious Waste Management Act and Regulation as follows: failed to pay the annual fees and late fees as a generator of infectious waste.

Action: The Individual/Entity is required to; pay annual fees and associated late fees in the amount of two hundred six dollars and twenty-five cents (\$206.25); and, pay a civil penalty in the amount of eight hundred dollars (**\$800.00**).

26) Order Type and Number: Consent Order 18-12-IW  
Order Date: July 20, 2018  
Individual/Entity: **Environmental Options, Inc.**  
Facility: Environmental Options, Inc.  
Location: 413 Energy Boulevard  
Rocky Mount, VA 24151  
Mailing Address: P.O. Box 879  
Rocky Mount, VA 24151  
County: Out of State Transporter  
Previous Orders: None



Permit/ID Number: N/A  
Violations Cited: The South Carolina Infectious Waste Management Act, §44-93-30 (2002), and the South Carolina Infectious Waste Management Regulation, 8 S.C. Code Ann. Regs. 61-105 (2012).

Summary: Environmental Options, Inc. (Individual/Entity) is a full service environmental company providing waste disposal options at its facility located at 413 Energy Boulevard, in Rocky Mount, Virginia. The Department conducted an inspection on April 25, 2018, at Greenville Women's Clinic PA (an infectious waste generator). The Individual/Entity has violated the South Carolina Infectious Waste Management Act and Regulations as follows: engaged in the transportation of infectious waste in South Carolina without registering annually with the Department as an infectious waste transporter and paying applicable fees; accepted a shipment of infectious waste that was transported within South Carolina without being accompanied by an infectious waste manifest; and, failed to ensure products of conception are incinerated, cremated, interred, or donated for medical research.

Action: The Individual/Entity is required to pay a civil penalty in the amount of five thousand, five hundred twenty-five dollars (**\$5,525.00**).

27) Order Type and Number: Consent Order 18-14-IW  
Order Date: August 2, 2018  
Individual/Entity: **Clean Management Environmental Group, Inc.**  
Facility: Clean Management Environmental Group, Inc.  
Location: 915 Industrial Road  
Walterboro, SC 29488  
Mailing Address: P.O. Box 1606  
Walterboro, SC 29488  
County: Colleton  
Previous Orders: None  
Permit/ID Number: N/A  
Violations Cited: The South Carolina Infectious Waste Management Act, §44-93-30 (2002), and the South Carolina Infectious Waste Management Regulation, 8 S.C. Code Ann. Regs. 61-105 (2012).

Summary: Clean Management Environmental Group, Inc. (Individual/Entity) is a full service environmental company providing a wide array of environmental services to include arranging for transportation of nonhazardous and hazardous waste for disposal, and other industrial services at its facility located at 915 Industrial Road, in Walterboro, South Carolina. An inspection was conducted on April 25, 2018 at Greenville Women's Clinic PA, an infectious waste generator. The Individual/Entity has violated the South Carolina Infectious Waste Management Act and the Infectious Waste Management Regulations as follows: failed to hire a registered infectious waste transporter (subcontractor) to transport Greenville Women's infectious waste and failed to have its subcontractor comply with the requirement that products of conception be incinerated, cremated, interred, or donated for medical research.

Action: The Individual/Entity is required to pay a civil penalty in the amount of four thousand, five hundred dollars (**\$4,500.00**).

28) Order Type and Number: Consent Order 18-15-IW  
Order Date: August 20, 2018  
Individual/Entity: **SterAssure Processing, LLC**  
Facility: SterAssure Processing, LLC  
Location: 4 Augusta Arbor Way

Greenville, SC 29605  
Mailing Address: Same  
County: Greenville  
Previous Orders: None  
Permit/ID Number: IWF000001  
Violations Cited: The South Carolina Infectious Waste Management Act, §44-93-30 (2002), and the South Carolina Infectious Waste Management Regulation, 8 S.C. Code Ann. Regs. 61-105 (2012).

Summary: SterAssure Processing, LLC (Individual/Entity) is a registered South Carolina infectious waste transporter with a treatment facility located at 4 Augusta Arbor Way, Greenville, South Carolina. The Department conducted inspections on December 4, 2017, and December 14, 2017. The Individual/Entity violated the South Carolina Infectious Waste Management Act and the Infectious Waste Management Regulations as follows: failed to properly operate and maintain all facilities and systems of treatment and control; failed to submit written notification of noncompliance within fifteen (15) days; failed to comply with and maintain facility documents as outlined in the regulations; failed to disinfect vehicle bodies and any surface that came in contact with infectious waste prior to reuse; failed to properly train employees; failed to comply with and post emergency preparedness and emergency response procedures; failed to maintain and complete manifests in accordance with the requirements; accepting infectious waste that was not labeled and packaged in accordance with the requirements; failed to store infectious waste in a manner that afforded protection from animals, vectors, weather conditions and the public; failed to properly maintain and repair the facility's treatment equipment; and failed to control the number of loaded and unloaded shipments of infectious waste to prevent a backlog of infectious waste stored onsite.

Action: The Individual/Entity is required to: not operate its treatment facility until it has submitted a permit modification to the Department for review and approval, pay a civil penalty in the amount of seven thousand, five hundred eighty dollars (**\$7,580.00**); and pay a suspended penalty in the amount of sixty eight thousand, two hundred twenty dollars (\$68,220.00) should any requirement of the Order not be met.

### **Mining Enforcement**

29) Order Type and Number: Consent Order 18-06-MSWM  
Order Date: July 09, 2018  
Individual/Entity: **Donald Richardson and Son, Inc.**  
Facility: Ricky's Dirt Pit  
Location: 0.3 Miles from the intersection of S-26-29 and S-26-962  
Horry County, SC  
Mailing Address: P.O. Box 205  
Conway, SC 29526  
County: Horry  
Previous Orders: None  
Permit/ID Number: I-001099  
Violations Cited: South Carolina Mining Act (2008 and Supp. 2015), and, South Carolina Mining Regulation (2012).

Summary: Donald Richardson and Son, Inc. (Individual/Entity) owns and operates a mine in Horry County, South Carolina. The Department conducted an inspection on April 11, 2017. The Individual/Entity has violated the South Carolina Mining Act, South Carolina Mining Regulation and the SC General Operating Permit as follows: conducted mining outside the permitted acreage allowed by the Individual Permit

Action: The Individual/Entity is required to: cease and desist all mining activities other than

reclamation of the site and pay a civil penalty in the amount of one thousand dollars **(\$1,000.00)**.

## **BUREAU OF WATER**

### **Recreational Waters Enforcement**

30) Order Type and Number: Administrative Order No. 18-087-RW  
Order Date: April 30, 2018  
Individual/Entity: MG Hotel Latta, LLC  
Facility: Best Western Executive Inn  
Location: 1534 Highway 38 West  
Latta, SC 29565  
Mailing Address: Same  
County: Dillon  
Previous Orders: 15-017-DW (\$840.00)  
15-089-RW (\$1,360.00)  
Permit/ID Number: 17-1001B  
Violations Cited: S.C. Code Ann. Regs. 61-51(J)

Summary: MG Hotel Latta, LLC (Individual/Entity) owns and is responsible for the proper operation and maintenance of a pool. On February 1, 2017, June 13, 2017, and December 28, 2017, the pool was inspected, and a violation was issued for failure to properly operate and maintain. The Individual/Entity has violated the Public Swimming Pools Regulation as follows: the chlorine and pH levels were not within the acceptable range of water quality standards; the bound and numbered log book was not available for review; and the current pool operator of record information was not posted to the public.

Action: The Individual/Entity is required to: submit a corrective action plan and schedule implementation to address the deficiencies; and pay a civil penalty in the amount of nine thousand dollars **(\$9,000.00)**.

31) Order Type and Number: Consent Order 18-097-RW  
Order Date: June 21, 2018  
Individual/Entity: **Princeton Place Homeowners Association, Inc.**  
Facility: Princeton Place  
Location: 4315 Princeton Place  
Little River, SC 29566  
Mailing Address: Same  
County: Horry  
Previous Orders: None  
Permit/ID Number: 26-J07-1  
Violations Cited: S.C. Code Ann. Regs. 61-51 (J)

Summary: Princeton Place Homeowners Association, Inc. (Individual/Entity) owns and is responsible for the proper operation and maintenance of a pool. On June 15, 2017, July 18, 2017, and July 27, 2017, the pool was inspected, and a violation was issued for failure to properly operate and maintain. The Individual/Entity has violated the Public Swimming Pools Regulation as follows: the pH level was not within the acceptable range of water quality standards; the facility address was not posted at the emergency notification device; the bound and numbered log book was not available for review; and there

was no drinking water fountain. On August 3, 2017, a follow-up inspection was conducted, and it was determined that all of the deficiencies had been addressed except for the installation of a drinking water fountain.

Action: The Individual/Entity is required to: install a drinking water fountain by April 1, 2018; and pay a civil penalty in the amount of one thousand, six hundred eighty dollars **(\$1,680.00)**. The civil penalty has been paid. The Individual/Entity has installed a drinking water fountain.

32) Order Type and Number: Consent Order 18-098-RW  
Order Date: June 25, 2018  
Individual/Entity: **701 South Ocean Blvd., LLC**  
Facility: Bali Bay  
Location: 701 South Ocean Boulevard  
Myrtle Beach, SC 29577  
Mailing Address: 5200 Blue Lagoon Drive, Suite 400  
Miami, FL 33126  
County: Horry  
Previous Orders: None  
Permit/ID Number: 26-1905B  
Violations Cited: S.C. Code Ann. Regs. 61-51(J)

Summary: 701 South Ocean Blvd., LLC (Individual/Entity) owns and is responsible for the proper operation and maintenance of a pool. On May 24, 2018, the pool was inspected, and a violation was issued for failure to properly operate and maintain. The Individual/Entity has violated the Public Swimming Pool Regulation as follows: a skimmer was missing a weir; the chlorine and pH levels were not within the acceptable range of water quality standards; the life ring was deteriorated and did not have a permanent attached rope; the shepherd's crook was missing a bolt and was not permanently attached to the handle; the emergency notification device was not operational; the pool rules sign was not completely filled out; the current pool operator of record information was not posted to the public; the bound and numbered log book was not available for review; and the pool equipment room was not accessible. On May 25, 2018, a follow-up inspection was conducted, and it was determined that all of the deficiencies had been addressed.

Action: The Individual/Entity is required to: pay a civil penalty in the amount of three hundred forty dollars **(\$340.00)**. The civil penalty has been paid.

33) Order Type and Number: Consent Order 18-099-RW  
Order Date: June 25, 2018  
Individual/Entity: **Wassamassaw Plantation Homeowners Association, Inc.**  
Facility: Wassamassaw Plantation  
Location: 1080 Wassamassaw Plantation Drive  
Moncks Corner, SC 29461  
Mailing Address: 7301 Rivers Avenue, Suite 245  
North Charleston, SC 29406  
County: Berkeley  
Previous Orders: None  
Permit/ID Number: 08-1039B  
Violations Cited: S.C. Code Ann. Regs. 61-51(J)

Summary: Wassamassaw Plantation Homeowners Association, Inc. (Individual/Entity) owns and is responsible for the proper operation and maintenance of a pool. On June 22, 2017, and August 8, 2017,

the pool was inspected, and a violation was issued for failure to properly operate and maintain. Individual/Entity has violated the Public Swimming Pools Regulation as follows: the pool wall was chipped; there was debris in the skimmer baskets; a skimmer was missing a weir; the bathrooms were not accessible; a gate did not self-close and latch; the chlorine and pH levels were not within the acceptable range of water quality standards; the emergency notification device was not operational; and the bound numbered log book was not maintained on a daily basis.

Action: The Individual/Entity is required to: submit a corrective action plan and schedule implementation to address the deficiencies; and pay a **suspended penalty** in the amount of six hundred eighty dollars (**\$680.00**) should any requirement of the Order not be met. The Individual/Entity submitted a corrective action plan and corrected the deficiencies.

34) Order Type and Number: Consent Order 18-100-RW  
Order Date: June 28, 2018  
Individual/Entity: **1751 Dogwood, LLC**  
Facility: Oasis at Ashley Apartments  
Location: 1751 Dogwood Road  
Charleston, SC 29414  
Mailing Address: Same  
County: Charleston  
Previous Orders: None  
Permit/ID Number: 10-1263B  
Violations Cited: S.C. Code Ann. Regs. 61-51(J)

Summary: 1751 Dogwood, LLC (Individual/Entity) owns and is responsible for the proper operation and maintenance of a pool. On May 29, 2018, the pool was inspected, and a violation was issued for failure to properly operate and maintain. The Individual/Entity has violated the Public Swimming Pools Regulation as follows: the foot rinse shower was not operating properly; there were non-pool-related items stored in the equipment room; the chlorine and pH levels were not within the acceptable range of water quality standards; the cyanuric acid level was above the water quality standards acceptable limit; the life ring did not have a permanently attached rope; the "Shallow Water - No Diving Allowed" signs did not have the correct wording; and the "No Lifeguard on Duty - Swim at Your Own Risk" signs did not have the correct wording.

Action: The Individual/Entity is required to: submit a corrective action plan and schedule implementation to address the deficiencies; and pay a civil penalty in the amount of three hundred forty dollars (**\$340.00**). The civil penalty has been paid. The Individual/Entity submitted a corrective action plan and corrected the deficiencies.

35) Order Type and Number: Consent Order 18-101-RW  
Order Date: July 3, 2018  
Individual/Entity: **Shri Asapuri, LLC**  
Facility: Clarion Inn  
Location: 310 Johnnie Dodds Boulevard  
Mount Pleasant, SC 29464  
Mailing Address: Same  
County: Charleston  
Previous Orders: None  
Permit/ID Number: 10-540-1  
Violations Cited: S.C. Code Ann. Regs. 61-51(J)

Summary: Shri Asapuri, LLC (Individual/Entity) owns and is responsible for the proper operation and maintenance of a pool. On May 31, 2018, the pool was inspected, and a violation was issued for failure to properly operate and maintain. The Individual/Entity has violated the Public Swimming Pools Regulation as follows: a ladder was missing bumpers; a skimmer was missing a weir; the foot rinse shower was not operating properly; there were non-pool related items stored in the equipment room; a light in the pool wall was out of its niche; the gate did not self-close and latch; the life ring was deteriorated; only one "Shallow Water - No Diving Allowed" sign was posted; only one "No Lifeguard On Duty - Swim At Your Own Risk" sign was posted; and the bound and numbered log book was not maintained on a daily basis.

Action: The Individual/Entity is required to: submit a corrective action plan and schedule implementation to address the deficiencies; and pay a civil penalty in the amount of three hundred forty dollars (**\$340.00**). The Individual/Entity submitted a corrective action plan and schedule of implementation to address the deficiencies.

36) Order Type and Number: Consent Order 18-102-RW  
Order Date: July 6, 2018  
Individual/Entity: **Fairway Lakes Homeowners Association, Inc.**  
Facility: Fairway Lakes  
Location: Fairway Lakes Drive (off of 3<sup>rd</sup> Avenue)  
Myrtle Beach, SC 29577  
Mailing Address: 1700 North Oak Street, Unit C  
Myrtle Beach, SC 29577  
County: Horry  
Previous Orders: None  
Permit/ID Number: 26-796-1  
Violations Cited: S.C. Code Ann. Regs. 61-51(J)

Summary: Fairway Lakes Homeowners Association, Inc. (Individual/Entity) owns and is responsible for the proper operation and maintenance of a pool. On May 30, 2018, the pool was inspected, and a violation was issued for failure to properly operate and maintain. The Individual/Entity has violated the Public Swimming Pools Regulation as follows: the lifeline floats were not properly spaced; a ladder was not tight and secure; a skimmer cover was broken; the bathroom did not have soap; a gate did not self-close and latch; the chlorine and pH levels were not within the acceptable range of water quality standards; and the bound and numbered log book was not maintained on a daily basis.

Action: The Individual/Entity is required to: submit a corrective action plan and schedule implementation to address the deficiencies; and pay a civil penalty in the amount of three hundred forty dollars (**\$340.00**). The civil penalty has been paid.

37) Order Type and Number: Consent Order 18-103-RW  
Order Date: July 6, 2018  
Individual/Entity: **Inlet Pointe Homeowners' Association, Inc.**  
Facility: Inlet Pointe  
Location: 1582 South Waccamaw Drive  
Murrells Inlet, SC 29576  
Mailing Address: Same  
County: Georgetown  
Previous Orders: None  
Permit/ID Number: 22-107-1  
Violations Cited: S.C. Code Ann. Regs. 61-51(J) &

61-51(K)(1)(c)

Summary: Inlet Pointe Homeowners' Association, Inc. (Individual/Entity) owns and is responsible for the proper operation and maintenance of a pool. On June 1, 2018, the pool was inspected, and a violation was issued for failure to properly operate and maintain; and on June 4, 2018, the pool was inspected, and a violation was issued for failure to properly operate and maintain and for re-opening prior to receiving Department approval. The Individual/Entity has violated the Public Swimming Pools Regulation as follows: a skimmer was missing a weir; there was no drinking water fountain; there was no life ring; the emergency notification device was not operational; a ladder was missing a bumper; the chlorine level was not within the acceptable range of water quality standards; and the pool was operating prior to receiving Department approval.

Action: The Individual/Entity is required to: submit a corrective action plan and schedule implementation to address the deficiencies; and pay a civil penalty in the amount of one thousand, two hundred dollars (**\$1,020.00**). The civil penalty has been paid.

38) Order Type and Number: Consent Order 18-104-RW  
Order Date: July 6, 2018  
Individual/Entity: **Lavenden, Inc.**  
Facility: Southern Breeze  
Location: 1901 South Ocean Boulevard  
Myrtle Beach, SC 29577  
Mailing Address: Same  
County: Horry  
Previous Orders: None  
Permit/ID Number: 26-624-1  
Violations Cited: S.C. Code Ann. Regs. 61-51(J)

Summary: Lavenden, Inc. (Individual/Entity) owns and is responsible for the proper operation and maintenance of a pool. On June 1, 2018, the pool was inspected, and a violation was issued for failure to properly operate and maintain. The Individual/Entity has violated the Public Swimming Pools Regulation as follows: a ladder was missing bumpers; a gate did not self-close and latch; the chlorine and pH levels were not within the acceptable range of water quality standards; the life ring and life ring rope were deteriorated; there was no pool rules sign; and the current pool operator of record information was not posted to the public.

Action: The Individual/Entity is required to: submit a corrective action plan and schedule implementation to address the deficiencies; and pay a civil penalty in the amount of three hundred forty dollars (**\$340.00**). The civil penalty has been paid. The Individual/Entity submitted a corrective action plan and corrected the deficiencies.

39) Order Type and Number: Consent Order 18-105-RW  
Order Date: July 11, 2018  
Individual/Entity: **Sejwad V, LLC**  
Facility: Holiday Inn Express  
Location: 7329 Garners Ferry Road  
Columbia, SC 29209  
Mailing Address: Same  
County: Richland  
Previous Orders: 16-019-RW (\$680.00)  
Permit/ID Number: 40-1057B

Violations Cited:

S.C. Code Ann. Regs. 61-51(J)

Summary: Sejwad V, LLC (Individual/Entity) owns and is responsible for the proper operation and maintenance of a pool. On March 1, 2018, May 18, 2018, and June 4, 2018, the pool was inspected, and violation was issued for failure to properly operate and maintain. The Individual/Entity has violated the Public Swimming Pools Regulation as follows: a ladder was missing bumpers; there was standing water on the pool deck; a skimmer was missing a weir; the chlorine level was not within the acceptable range of water quality standards; and the bound and numbered log book was not maintained on a daily basis.

Action: The Individual/Entity is required to: submit a corrective action plan and schedule implementation to address the deficiencies; and pay a civil penalty in the amount of four thousand, eight hundred dollars (**\$4,080.00**). The civil penalty has been paid.

40) Order Type and Number: Consent Order 18-106-RW  
Order Date: July 11, 2018  
Individual/Entity: **Landmark Homeowners' Association, Inc.**  
Facility: Landmark Resort  
Location: 1501 South Ocean Boulevard  
Myrtle Beach, SC 29577  
Mailing Address: 4615 Oleander Drive, Suite 202  
Myrtle Beach, SC 29577  
County: Horry  
Previous Orders: None  
Permit/ID Number: 26-L67-1, 26-L59-1, 26-L69-1  
Violations Cited: S.C. Code Ann. Regs. 61-51(J)

Summary: Landmark Homeowners' Association, Inc. (Individual/Entity) owns and is responsible for the proper operation and maintenance of a pool, kiddie pool, and spa. On March 5, 2018, the spa was inspected, and a violation was issued for failure to properly operate and maintain; and on May 23, 2018, the pool, kiddie pool, and spa were inspected, and violations were issued for failure to properly operate and maintain. The Individual/Entity has violated the Public Swimming Pools Regulation as follows: the deck was chipped; a skimmer basket was floating; the chlorine level was not within the acceptable range of water quality standards; a ladder was missing bumpers; there was no drinking water fountain; a gate did not self-close and latch; only one "Shallow Water - No Diving Allowed" sign was posted; only one "No Lifeguard On Duty - Swim At Your Own Risk" sign was posted; the current pool operator of record information was not posted to the public; the foot rinse shower was not operating properly; a section of the perimeter fencing was missing; the emergency notification device was not operational; the pool rule sign was not completely filled out; the bound and numbered log book was not available for review (pool and spa); the bound and numbered log book was not maintained on a daily basis (kiddie pool); and there was no spa rules sign.

Action: The Individual/Entity is required to: submit a corrective action plan and schedule implementation to address the deficiencies; and pay a civil penalty in the amount of one thousand, three hundred sixty dollars (**\$1,360.00**). The Individual/Entity submitted a corrective action plan and corrected the deficiencies.



41) Order Type and Number: Consent Order 18-108-RW  
Order Date: July 11, 2018  
Individual/Entity: **Core Campus Columbia I, LLC**  
Facility: Hub on Campus Columbia  
Location: 1426 Main Street  
Columbia, SC 29201  
Mailing Address: 3508 Far West Boulevard, Suite 355  
Austin, TX 78731  
County: Richland  
Previous Orders: 17-107-RW (\$1,020.00);  
18-083-RW (\$1,360.00)  
Permit/ID Number: 40-1143D  
Violations Cited: S.C. Code Ann. Regs. 61-51(J)

Summary: Core Campus Columbia I, LLC (Individual/Entity) owns and is responsible for the proper operation and maintenance of a spa. On May 23, 2018, the spa was inspected, and a violation was issued for failure to properly operate and maintain. The Individual/Entity has violated the Public Swimming Pool Regulation as follows: the foot rinse shower was not operating properly; the pH level was not within the acceptable range of water quality standards; the main drain grate was not in place; the emergency notification device was not operational; there was no pool rules sign; only one "No Lifeguard On Duty - Swim At Your Own Risk" sign was posted; the facility could not produce current valid documentation of pool operator certification; the bound and numbered log book was not available for review; the disinfecting equipment was not operating properly; and the automatic controller was not operating properly.

Action: The Individual/Entity is required to: submit a corrective action plan and schedule implementation to address the deficiencies; and pay a civil penalty in the amount of two thousand, two hundred dollars (**\$2,200.00**). The civil penalty has been paid.

42) Order Type and Number: Consent Order 18-107-RW  
Order Date: July 16, 2018  
Individual/Entity: **Charleston Properties I, LLC**  
Facility: 930 NoMo  
Location: 930 Morrison Drive  
Charleston, SC 29414  
Mailing Address: Same  
County: Charleston  
Previous Orders: None  
Permit/ID Number: 10-1251B  
Violations Cited: S.C. Code Ann. Regs. 61-51(J)

Summary: Charleston Properties I, LLC (Individual/Entity) owns and is responsible for the proper operation and maintenance of a pool. On May 24, 2018, the pool was inspected, and a violation was issued for failure to properly operate and maintain. The Individual/Entity has violated the Public Swimming Pool Regulation as follows: the bathrooms did not have paper towels; the drinking water fountain was not operating properly; a light in the pool wall was out of its niche; the chlorine level was not within the acceptable range of water quality standards; the main drain grate was broken; there was no life ring; the emergency notification device was not approvable; the bound and numbered log book was not available for review; and there were chlorine sticks in the skimmer baskets.

Action: The Individual/Entity is required to: submit a corrective action plan and schedule implementation to address the deficiencies; and pay a civil penalty in the amount of three hundred forty dollars (**\$340.00**).

43) Order Type and Number: Consent Order 18-109-RW  
Order Date: July 16, 2018  
Individual/Entity: **Pawley's Pier Village, Inc.**  
Facility: Pawley's Pier Village  
Location: 320 Myrtle Avenue  
Pawleys Island, SC 29585  
Mailing Address: Same  
County: Georgetown  
Previous Orders: None  
Permit/ID Number: 22-012-1  
Violations Cited: S.C. Code Ann. Regs. 61-51(J)

Summary: Pawley's Pier Village, Inc. (Individual/Entity) owns and is responsible for the proper operation and maintenance of a pool. On June 4, 2018, the pool was inspected, and a violation was issued for failure to properly operate and maintain. The Individual/Entity has violated the Public Swimming Pool Regulation as follows: a skimmer was missing a weir; there was no drinking water fountain; the chlorine level was not within the acceptable range of water quality standards; the life ring was deteriorated and was not United States Coast Guard approved; the emergency notification device was not approvable; only one "Shallow Water - No Diving Allowed" sign was posted; the current pool operator of record information was not posted to the public; the facility could not produce current valid documentation of pool operator certification; the disinfection equipment was not accessible; and the automatic controller was not accessible. Later that day, a follow-up inspection was conducted, and it was determined that all of the deficiencies had been addressed.

Action: The Individual/Entity is required to: pay a civil penalty in the amount of three hundred forty dollars (**\$340.00**). The civil penalty has been paid.

44) Order Type and Number: Consent Order 18-110-RW  
Order Date: July 16, 2018  
Individual/Entity: **DBC Woodland Village Limited Partnership**  
Facility: Woodland Village Apartments  
Location: 2221 Bush River Road  
Columbia, SC 29212  
Mailing Address: 51 Pennwood Place, Suite 200  
Warrendale, PA 15086  
County: Lexington  
Previous Orders: None  
Permit/ID Number: 32-036-1, 32-049-1  
Violations Cited: S.C. Code Ann. Regs. 61-51(J) & 61-51(K)(1)(c)

Summary: DBC Woodland Village Limited Partnership (Individual/Entity) owns and is responsible for the proper operation and maintenance of two pools. On April 9, 2018, the pools were inspected, and violations were issued for failure to properly operate and maintain; and on June 8, 2018, the pools were inspected, and a violation was issued for re-opening pool Permit No. 32-036-1 prior to receiving Department approval. Pool Permit No. 32-049-1 was closed to the public. The Individual/Entity has violated the Public Swimming Pools Regulation as follows: there were cracked floats on the lifeline; a ladder and handrail were not tight and secure; the pool floor and walls were dirty; there was algae on the pool wall; the pool furniture was not at least four feet from the edge of the pool; there was debris in the skimmer baskets; a skimmer was missing a weir; the water level was too low; the drinking water fountain was not operating properly; the foot rinse shower was not operating properly; the main drain grates were not visible due to cloudy water; the life ring was deteriorated; there was no shepherd's crook; there was no pool rules sign; there

were no “Shallow Water – No Diving Allowed” signs posted; there were no “No Lifeguard On Duty – Swim At Your Own Risk” signs posted; the current pool operator of record information was not posted to the public; the bound and numbered log book was not available for review; the disinfection equipment was not operating properly; and pool Permit No. 32-036-1 was operating prior to receiving Department approval.

Action: The Individual/Entity is required to: submit a corrective action plan and schedule implementation to address the deficiencies; and pay a civil penalty in the amount of seven hundred seventy dollars (**\$770.00**). The civil penalty has been paid.

45) Order Type and Number: Consent Order 18-111-RW  
Order Date: July 16, 2018  
Individual/Entity: **Shri Hari Properties of Columbia, LLC**  
Facility: Quality Inn  
Location: 499 Piney Grove Road  
Columbia, SC 29615  
Mailing Address: 4308 Broad Street  
Sumter, SC 29154  
County: Lexington  
Previous Orders: None  
Permit/ID Number: 32-128-1  
Violations Cited: S.C. Code Ann. Regs. 61-51(J)

Summary: Shri Hari Properties of Columbia, LLC (Individual/Entity) owns and is responsible for the proper operation and maintenance of a pool. On June 4, 2018, the pool was inspected, and a violation was issued for failure to properly operate and maintain. The Individual/Entity has violated the Public Swimming Pools Regulation as follows: a ladder was missing bumpers; there was no drinking water fountain; there was no foot rinse shower; there were non-pool related items stored in the equipment room; the pool equipment room piping was leaking; a gate did not self-close and latch; the chlorine level was not within the acceptable range of water quality standards; the pool rules sign was not completely filled out; only one “No Lifeguard On Duty – Swim At Your Own Risk” sign was posted; the current pool operator of record information was not posted to the public; and the bound and numbered log book was not maintained on a daily basis.

Action: The Individual/Entity is required to: submit a corrective action plan and schedule implementation to address the deficiencies; and pay a civil penalty in the amount of three hundred forty dollars (**\$340.00**). The civil penalty has been paid.

46) Order Type and Number: Consent Order 18-112-RW  
Order Date: July 16, 2018  
Individual/Entity: **The Palace Horizontal Property Regime, Inc.**  
Facility: Myrtle Beach Palace Resort  
Location: 1605 South Ocean Boulevard  
Myrtle Beach, SC 29577  
Mailing Address: 7400 North Kings Highway  
Myrtle Beach, SC 29572  
County: Horry  
Previous Orders: None  
Permit/ID Number: 26-C32-1  
Violations Cited: S.C. Code Ann. Regs. 61-51(J)

Summary: The Palace Horizontal Property Regime, Inc. (Individual/Entity) owns and is responsible for the proper operation and maintenance of a spa. On February 14, 2018, and May 30, 2018, the spa was inspected, and a violation was issued for failure to properly operate and maintain. The Individual/Entity has violated the Public Swimming Pools Regulation as follows: the chlorine and pH levels were not within the acceptable range of water quality standards.

Action: The Individual/Entity is required to: submit a corrective action plan and schedule implementation to address the deficiencies; and pay a civil penalty in the amount of six hundred eighty dollars (**\$680.00**). The Individual/Entity submitted a corrective action plan and corrected the deficiencies.

47) Order Type and Number: Consent Order 18-113-RW  
Order Date: July 17, 2018  
Individual/Entity: **The St. Clements Homeowners Association, Inc.**  
Facility: St. Clements  
Location: 70<sup>th</sup> Avenue North  
Myrtle Beach, SC 29572  
Mailing Address: 1125 48<sup>th</sup> Avenue North  
Myrtle Beach, SC 29577  
County: Horry  
Previous Orders: None  
Permit/ID Number: 26-E53-1  
Violations Cited: S.C. Code Ann. Regs. 61-51(J)

Summary: The St. Clements Homeowners Association, Inc. (Individual/Entity) owns and is responsible for the proper operation and maintenance of a pool. On May 30, 2018, the pool was inspected and a violation was issued for failure to properly operate and maintain. The Individual/Entity has violated the Public Swimming Pools Regulation as follows: a skimmer basket was missing a weir; there was no drinking water fountain; the shepherd's crook was not mounted in the designated location; the pool rule sign was not completely filled out; only one "No Lifeguard On Duty - Swim At Your Own Risk" sign was posted; and the current pool operator of record information was not posted to the public. Later that day a follow-up inspection was conducted, and it was determined that all of the deficiencies had been addressed.

Action: The Individual/Entity is required to: pay a civil penalty in the amount of three hundred forty dollars (**\$340.00**).

48) Order Type and Number: Consent Order 18-115-RW  
Order Date: July 23, 2018  
Individual/Entity: **MB Hotel, Inc.**  
Facility: Cabana Shores  
Location: 5701 North Ocean Boulevard  
Myrtle Beach, SC 29577  
Mailing Address: Same  
County: Horry  
Previous Orders: None  
Permit/ID Number: 26-534-1  
Violations Cited: S.C. Code Ann. Regs. 61-51(J)

Summary: MB Hotel, Inc. (Individual/Entity) owns and is responsible for the proper operation and maintenance of a pool. On June 5, 2018, the pool was inspected, and a violation was issued for failure to properly operate and maintain. The Individual/Entity has violated the Public Swimming Pools Regulation

follows: tiles on the pool wall were missing; a skimmer was missing a weir; the foot rinse shower was not operating properly; there was no drinking water fountain; there was no life ring; there was no shepherd's crook; there was no pool rules sign; and the bound and numbered log book was not maintained on a daily basis.

Action: The Individual/Entity is required to: submit a corrective action plan and schedule implementation to address the deficiencies; and pay a civil penalty in the amount of three hundred forty dollars **(\$340.00)**.

49) Order Type and Number: Consent Order 18-116-RW  
Order Date: July 23, 2018  
Individual/Entity: **Atalaya Towers Homeowner's Association, Inc.**  
Facility: Atalaya Towers  
Location: 912 North Waccamaw Drive  
Murrells Inlet, SC 29576  
Mailing Address: Same  
County: Horry  
Previous Orders: None  
Permit/ID Number: 26-E41-1  
Violations Cited: S.C. Code Ann. Regs. 61-51(J)

Summary: Atalaya Towers Homeowner's Association, Inc. (Individual/Entity) owns and is responsible for the proper operation and maintenance of a pool. On June 12, 2018, the pool was inspected and a violation was issued for failure to properly operate and maintain. The Individual/Entity has violated the Public Swimming Pools Regulation as follows: a skimmer was missing a weir; there was no drinking water fountain; the chlorine and pH levels were not within the acceptable range of water quality standards; the cyanuric acid level was above the water quality standards acceptable limit; the shepherd's crook was missing a bolt; and the bound and numbered log book was not maintained on a daily basis.

Action: The Individual/Entity is required to: submit a corrective action plan and schedule implementation to address the deficiencies; and pay a civil penalty in the amount of three hundred forty dollars **(\$340.00)**. The civil penalty has been paid.

50) Order Type and Number: Consent Order 18-117-RW  
Order Date: July 23, 2018  
Individual/Entity: **Southwood Realty Company**  
Facility: Sabal Palms Apartment Homes  
Location: 100 Lochaven Drive  
Charleston, SC 29414  
Mailing Address: P.O. Box 280  
Gastonia, NC 28054  
County: Charleston  
Previous Orders: None  
Permit/ID Number: 10-1050B  
Violations Cited: S.C. Code Ann. Regs. 61-51(J)

Summary: Southwood Realty Company (Individual/Entity) owns and is responsible for the proper operation and maintenance of a pool. On May 18, 2018, and June 27, 2018, the pool was inspected, and a violation was issued for failure to properly operate and maintain. The Individual/Entity has violated the Public Swimming Pools Regulation as follows: a ladder was missing bumpers; only one "Shallow Water -

No Diving Allowed" sign was posted; only one "No Lifeguard On Duty - Swim At Your Own Risk" sign was posted; the current pool operator of record information was not posted to the public; the log book was not properly bound and numbered; the chlorine level was not within the acceptable range of water quality standards; and the cyanuric acid level was above the water quality standards acceptable limit.

Action: The Individual/Entity is required to: submit a corrective action plan and schedule implementation to address the deficiencies; and pay a civil penalty in the amount of six hundred eighty dollars **(\$680.00)**.

51) Order Type and Number: Consent Order 18-118-RW  
Order Date: July 23, 2018  
Individual/Entity: **Lullwater at Saluda Pointe, LLC**  
Facility: Lullwater at Saluda Pointe  
Location: 101 Saluda Pointe Drive  
Lexington, SC 29071  
Mailing Address: Same  
County: Lexington  
Previous Orders: None  
Permit/ID Number: 32-1053B & 32-1054D  
Violations Cited: S.C. Code Ann. Regs. 61-51(J)

Summary: Lullwater at Saluda Pointe, LLC (Individual/Entity) owns and is responsible for the proper operation and maintenance of a pool and a spa. On March 13, 2018, the spa was inspected, and a violation was issued for failure to properly operate and maintain; and on June 8, 2018, the pool and spa were inspected, and violations were issued for failure to properly operate and maintain. The Individual/Entity has violated the Public Swimming Pools Regulation as follows: the water level was low; the coping was detached from the deck; all of the skimmer baskets were floating; the pump room door was open; the chlorine and pH levels were not within the acceptable range of water quality standards; the bound and numbered log book was not being maintained properly; and the disinfection equipment was not operating properly and the piping was leaking.

Action: The Individual/Entity is required to: submit a corrective action plan and schedule implementation to address the deficiencies; and pay a civil penalty in the amount of one thousand, two hundred dollars **(\$1,020.00)**.

52) Order Type and Number: Consent Order 18-114-RW  
Order Date: July 24, 2018  
Individual/Entity: **Jai Sat Chit Ananad, LLC**  
Facility: Days Inn Richburg  
Location: 3217 Lancaster Highway  
Richburg, SC 29729  
Mailing Address: Same  
County: Chester  
Previous Orders: None  
Permit/ID Number: 12-008-1  
Violations Cited: S.C. Code Ann. Regs. 61-51(J)

Summary: Jai Sat Chit Ananad, LLC (Individual/Entity) owns and is responsible for the proper operation and maintenance of a pool. On June 12, 2018, the pool was inspected, and a violation was issued for failure to properly operate and maintain. The Individual/Entity has violated the Public Swimming Pool Regulation as follows: the plaster on the pool floor was chipped; the drinking water fountain was not

operating properly; the pool equipment room was not locked; the cyanuric acid level was above the water quality standards acceptable limit; there was no pool rules sign; only one "Shallow Water - No Diving Allowed" sign was posted; only one "No Lifeguard On Duty - Swim At Your Own Risk" sign was posted; the current pool operator of record information was not posted to the public; the log book was not properly bound and numbered; and the log book was not maintained on a daily basis.

Action: The Individual/Entity is required to: submit a corrective action plan and schedule implementation to address the deficiencies; and pay a civil penalty in the amount of three hundred forty dollars **(\$340.00)**. The civil penalty has been paid.

53) Order Type and Number: Consent Order 18-120-RW  
Order Date: July 24, 2018  
Individual/Entity: **Sanam Hospitality, LLC**  
Facility: Quality Inn and Suites  
Location: 1004 South Ocean Boulevard  
Myrtle Beach, SC 29577  
Mailing Address: Same  
County: Horry  
Previous Orders: None  
Permit/ID Number: 26-450-1  
Violations Cited: S.C. Code Ann. Regs. 61-51(J) & 61-51(K)(1)(c)

Summary: Sanam Hospitality, LLC (Individual/Entity) owns and is responsible for the proper operation and maintenance of a pool. On May 24, 2018, the pool was inspected, and a violation was issued for failure to properly operate and maintain; and on May 29, 2018, the pool was inspected, and a violation was issued for failure to properly operate and maintain and for reopening prior to receiving Department approval. The Individual/Entity has violated the Public Swimming Pools Regulation as follows: a ladder was not tight and secure and was missing bumpers; there was no drinking water fountain; a gate did not self close and latch; the deck was not clean and clear of hazards; a section of the perimeter fencing had openings greater than four inches; the life ring was deteriorated; the bound and numbered log book was not maintained on a daily basis; and the pool was operating prior to receiving Department approval.

Action: The Individual/Entity is required to: submit a corrective action plan and schedule implementation to address the deficiencies; and pay a civil penalty in the amount of one thousand, two hundred dollars **(\$1,020.00)**. The civil penalty has been paid.

54) Order Type and Number: Consent Order 18-119-RW  
Order Date: July 25, 2018  
Individual/Entity: **Inlet Gardens Homeowners Association, Inc.**  
Facility: Inlet Gardens  
Location: Pendergrass Avenue  
Murrells Inlet, SC 29576  
Mailing Address: 5177 Inlet Garden Court  
Murrells Inlet, SC 29576  
County: Georgetown  
Previous Orders: None  
Permit/ID Number: 22-048-1  
Violations Cited: S.C. Code Ann. Regs. 61-51(J)

Summary: Inlet Gardens Homeowners Association, Inc. (Individual/Entity) owns and is responsible for the proper operation and maintenance of a pool. On June 11, 2018, the pool was inspected, and a

violation was issued for failure to properly operate and maintain. The Individual/Entity has violated the Public Swimming Pools Regulation as follows: a skimmer was missing a weir; the drinking water fountain was not operating; there was no foot rinse shower; the gate did not self-close and latch; the emergency notification device was not operating; the current pool operator of record information was not posted to the public; the bound and numbered log book was not available for review; and there were chlorine sticks in the skimmer baskets. On June 13, 2018, a follow-up inspection was conducted, and it was determined that all of the deficiencies had been addresses.

Action: The Individual/Entity is required to: pay a civil penalty in the amount of three hundred forty dollars (**\$340.00**). The civil penalty has been paid.

55) Order Type and Number: Consent Order 18-121-RW  
Order Date: July 27, 2018  
Individual/Entity: **Sesqui Place at Wildewood HOA, Inc.**  
Facility: Sesqui Place at Wildewood  
Location: 463 Sesqui Trail  
Columbia, SC 29223  
Mailing Address: 12 Sesqui Court  
Columbia, SC 29223  
County: Richland  
Previous Orders: None  
Permit/ID Number: 40-350-1, 40-351-1  
Violations Cited: S.C. Code Ann. Regs. 61-51(J)(22)

Summary: Sesqui Place at Wildewood HOA, Inc. (Individual/Entity) owns and is responsible for the proper operation and maintenance of a pool and kiddie pool. On May 30, 2017, September 1, 2017, June 4, 2018, and June 15, 2018, Department staff conducted inspections of the pool and kiddie pool and observed that the pool and kiddie pool were closed to the public and were not being operated maintained. Following the inspections, Department staff determined that the pool and kiddie pool have been permanently closed. The Individual/Entity has violated the Public Swimming Pools Regulation as follows: failure to appropriately cover the pool and kiddie pool or drain the pool and kiddie pool of stagnant water and secure them with a fence to prevent access.

Action: The Individual/Entity is required to: make all required operational and maintenance upgrades to the pool and kiddie pool or fill in or remove the pool and kiddie pool in accordance with an approved change order request form; and pay a **stipulated penalty** in the amount of six hundred eighty dollars (**\$680.00**) should any requirement of the Order not be met.

56) Order Type and Number: Consent Order 18-122-RW  
Order Date: July 30, 2018  
Individual/Entity: **Continental 234 Fund, LLC**  
Facility: Springs at Essex Farms  
Location: 3245 Glenn McConnell Parkway  
Charleston, SC 29414  
Mailing Address: Same  
County: Charleston  
Previous Orders: None  
Permit/ID Number: 10-1246B  
Violations Cited: S.C. Code Ann. Regs. 61-51(J)



Summary: Continental 234 Fund, LLC (Individual/Entity) owns and is responsible for the proper operation and maintenance of a pool. On May 23, 2018, and June 26, 2018, the pool was inspected, and a violation was issued for failure to properly operate and maintain. The Individual/Entity has violated the Public Swimming Pools Regulation as follows: the chlorine and pH levels were not within the acceptable range of water quality standards; the cyanuric acid level was above the water quality standards acceptable limit; and the bound and numbered log book was not maintained on a daily basis.

Action: The Individual/Entity is required to: submit a corrective action plan and schedule implementation to address the deficiencies; and pay a civil penalty in the amount of six hundred eighty dollars **(\$680.00)**.

57) Order Type and Number: Consent Order 18-123-RW  
Order Date: July 30, 2018  
Individual/Entity: **KTAD RE Holdings, LLC**  
Facility: KTAD  
Location: 407 9<sup>th</sup> Avenue South  
Myrtle Beach, SC 29577  
Mailing Address: Same  
County: Horry  
Previous Orders: None  
Permit/ID Number: 26-1955B & 26-1956D  
Violations Cited: S.C. Code Ann. Regs. 61-51(J)

Summary: KTAD RE Holdings, LLC (Individual/Entity) owns and is responsible for the proper operation and maintenance of a pool and a spa. On June 13, 2018, the pool and spa were inspected, and violations were issued for failure to properly operate and maintain. The Individual/Entity has violated the Public Swimming Pools Regulation as follows: the gate did not self-close and latch; the chlorine and pH levels were not within the acceptable range of water quality standards; the emergency notification device was not operating; the pool rules sign was not completely filled out; only one "No Lifeguard On Duty - Swim At Your Own Risk" sign was posted; the current pool operator of record information was not posted to the public; the bound and numbered log book was not maintained on a daily basis; the spa water level was too high and the spa was overflowing; and the spa rules sign was not completely filled out.

Action: The Individual/Entity is required to: submit a corrective action plan and schedule implementation to address the deficiencies; and pay a civil penalty in the amount of six hundred eighty dollars **(\$680.00)**. The civil penalty has been paid.

58) Order Type and Number: Consent Order 18-124-RW  
Order Date: July 30, 2018  
Individual/Entity: **Shree Hari Hospitality Columbia, LLC**  
Facility: Comfort Suites  
Location: 1540 Daulton Drive  
Columbia, SC 29223  
Mailing Address: Same  
County: Richland  
Previous Orders: None  
Permit/ID Number: 40-1090B  
Violations Cited: S.C. Code Ann. Regs. 61-51(J)

Summary: Shree Hari Hospitality Columbia, LLC (Individual/Entity) owns and is responsible for the proper operation and maintenance of a pool. On May 18, 2018, and May 29, 2018, the pool was inspected

and a violation was issued for failure to properly operate and maintain. The Individual/Entity has violated the Public Swimming Pools Regulation as follows: a handrail was not tight and secure; a ladder was not tight and secure; a skimmer was missing a weir; a gate did not self-close and latch; the chlorine level was not within the acceptable range of water quality standards; the cyanuric acid level was above the water quality standards acceptable limit; and the bound and numbered log book was not available for review on the first inspection and was not maintained on a daily basis on the second inspection.

Action: The Individual/Entity is required to: submit a corrective action plan and schedule implementation to address the deficiencies; and pay a civil penalty in the amount of six hundred eighty dollars **(\$680.00)**.

59) Order Type and Number: Consent Order 18-125-RW  
Order Date: July 30, 2018  
Individual/Entity: **Westcott Ridge Homeowner's Association**  
Facility: Westcott Ridge Amenity Center  
Location: Westcott Ridge Road  
Chapin, SC 29036  
Mailing Address: 4910 Trenholm Road  
Columbia, SC 29206  
County: Richland  
Previous Orders: None  
Permit/ID Number: 40-1100B  
Violations Cited: S.C. Code Ann. Regs. 61-51(J)

Summary: Westcott Ridge Homeowner's Association (Individual/Entity) owns and is responsible for the proper operation and maintenance of a pool. On June 22, 2018, the pool was inspected, and a violation was issued for failure to properly operate and maintain. The Individual/Entity has violated the Public Swimming Pools Regulation as follows: the lifeline rope was deteriorated and the floats were not properly spaced; a "No Diving" tile was missing; the pool floor was dirty; the pool furniture was not at least four feet from the edge of the pool; a skimmer was missing a weir; non pool-related items were stored in the equipment room; the pool equipment room piping was leaking; the chlorine level was not within acceptable range of water quality standards; the life ring rope was tangled; the bolts on the shepherd's crook were loose; the emergency notification device was not operational; the pool rules sign was not completely filled out; and the bound and numbered log book was missing cyanuric acid readings.

Action: The Individual/Entity is required to: submit a corrective action plan and schedule implementation to correct the deficiencies; and pay a civil penalty in the amount of three hundred forty dollars **(\$340.00)**.

60) Order Type and Number: Consent Order 18-126-RW  
Order Date: July 30, 2018  
Individual/Entity: **Heron Reserve Limited Partnership**  
Facility: Heron Reserve Apartments  
Location: 3301 Glenn McConnell Pkwy  
Charleston, SC 29414  
Mailing Address: P.O. Box 31417  
Charleston, SC 29417  
County: Charleston  
Previous Orders: None  
Permit/ID Number: 10-568-1  
Violations Cited: S.C. Code Ann. Regs. 61-51(J)

Summary: Heron Reserve Limited Partnership (Individual/Entity) owns and is responsible for the proper operation and maintenance of a pool. On May 18, 2018, and June 26, 2018, the pool was inspected and a violation was issued for failure to properly operate and maintain. The Individual/Entity has violated the Public Swimming Pools Regulation as follows: the chlorine and pH levels were not within the acceptable range of water quality standards; the cyanuric acid level was above the water quality standards acceptable limit; and the bound and numbered log book was not maintained on a daily basis.

Action: The Individual/Entity is required to: submit a corrective action plan and schedule implementation to address the deficiencies; and pay a civil penalty in the amount of six hundred eighty dollars **(\$680.00)**. The civil penalty has been paid. The Individual/Entity submitted a corrective action plan and corrected the deficiencies.

61) Order Type and Number: Consent Order 18-127-RW  
Order Date: August 3, 2018  
Individual/Entity: **Lakewood Village Council of Co-Owners, Inc.**  
Facility: Lakewood Village Condos  
Location: 240 Jamil Road  
Columbia, SC 29210  
Mailing Address: 1320 Main Street, Suite 300  
Columbia, SC 29201  
County: Lexington  
Previous Orders: None  
Permit/ID Number: 32-094-1  
Violations Cited: S.C. Code Ann. Regs. 61-51(J)

Summary: Lakewood Village Council of Co-Owners, Inc. (Individual/Entity) owns and is responsible for the proper operation and maintenance of a pool. On June 6, 2018, and July 12, 2018, the pool was inspected, and a violation was issued for failure to properly operate and maintain. The Individual/Entity has violated the Public Swimming Pools Regulation as follows: the lifeline floats were not properly spaced; depth marker tiles were missing; a handrail was not tight and secure; a ladder was missing bumpers; the pool floor was dirty; the pool walls were dirty; the deck was uneven with sharp edges; there was debris in the skimmer baskets; a skimmer was missing a weir; the bathroom was not clean; the step edge tile strip was not within one inch of the edge of the step; the pool equipment room piping was leaking; the life ring was deteriorated; the emergency notification device was not operational; the facility address was not posted at the emergency notification device; the pool rules sign was not completely filled out; the current pool operator of record information was not posted to the public; and the bound and numbered log book was not maintained on a daily basis.

Action: The Individual/Entity is required to: submit a corrective action plan and schedule implementation to address the deficiencies; and pay a civil penalty in the amount of six hundred eighty dollars **(\$680.00)**.

62) Order Type and Number: Consent Order 18-128-RW  
Order Date: August 8, 2018  
Individual/Entity: **Seabrook Island Club**  
Facility: Seabrook Island Club  
Location: 3772 Seabrook Island Road  
Johns Island, SC 29455  
Mailing Address: Same

County: Charleston  
Previous Orders: None  
Permit/ID Number: 10-1182B  
Violations Cited: S.C. Code Ann. Regs. 61-51(J)

Summary: Seabrook Island Club (Individual/Entity) owns and is responsible for the proper operation and maintenance of a pool. On June 6, 2018, and July 10, 2018, the pool was inspected, and a violation was issued for failure to properly operate and maintain. The Individual/Entity has violated the Public Swimming Pools Regulation as follows: the chlorine and pH levels were not within the acceptable range of water quality standards.

Action: The Individual/Entity is required to: submit a corrective action plan and schedule implementation to address the deficiencies; and pay a civil penalty in the amount of six hundred eighty dollars **(\$680.00)**. The civil penalty has been paid. The Individual/Entity submitted a corrective action plan and corrected the deficiencies.

63) Order Type and Number: Consent Order 18-129-RW  
Order Date: August 10, 2018  
Individual/Entity: **Carnaby Square Association, Inc.**  
Facility: Carnaby Square Condominiums  
Location: 1700 Grays Inn Road  
Columbia, SC 29210  
Mailing Address: Same  
County: Richland  
Previous Orders: None  
Permit/ID Number: 40-065-1  
Violations Cited: S.C. Code Ann. Regs. 61-51(J)

Summary: Carnaby Square Association, Inc. (Individual/Entity) owns and is responsible for the proper operation and maintenance of a pool. On June 14, 2018, and July 11, 2018, the pool was inspected and a violation was issued for failure to properly operate and maintain. The Individual/Entity has violated the Public Swimming Pools Regulation as follows: there were cracked floats on the lifeline; a ladder was not tight and secure and was missing bumpers; a skimmer was missing a weir; there was no drinking water fountain; the foot rinse shower was not operating properly; the fill spout was not made of stainless steel or equivalent; the facility address was not posted at the emergency notification device; the pool wall was dirty; and the cyanuric acid level was not checked weekly.

Action: The Individual/Entity is required to: submit a corrective action plan and schedule implementation to address the deficiencies; and pay a civil penalty in the amount of six hundred eighty dollars **(\$680.00)**.

64) Order Type and Number: Consent Order 18-130-RW  
Order Date: August 10, 2018  
Individual/Entity: **Bees Ferry-FCA, LLC**  
Facility: Bees Ferry Apartments  
Location: 2020 Proximity Drive  
Charleston, SC 29414  
Mailing Address: 300 South Trion Street, Suite 420  
Charlotte, NC 28202  
County: Charleston  
Previous Orders: 16-109-RW (\$680.00)

Permit/ID Number: 10-1216B & 10-1217D  
Violations Cited: S.C. Code Ann. Regs. 61-51(J)

Summary: Bees Ferry-FCA, LLC (Individual/Entity) owns and is responsible for the proper operation and maintenance of a pool and a spa. On May 8, 2018, and June 26, 2018, the pool and spa were inspected and violations were issued for failure to properly operate and maintain. The Individual/Entity has violated the Public Swimming Pools Regulation as follows: the chlorine and pH levels were not within the acceptable range of water quality standards; the cyanuric acid level was above the water quality standards acceptable limit; the emergency notification device was not operating; the pool/spa rules signs were not completely filled out; the cyanuric acid levels were not recorded in the bound and numbered log book; and the bound and numbered log book was not maintained on a daily basis.

Action: The Individual/Entity is required to: submit a corrective action plan and schedule implementation to address the deficiencies; and pay a civil penalty in the amount of two thousand, forty dollars **(\$2,040.00)**.

65) Order Type and Number: Consent Order 18-131-RW  
Order Date: August 13, 2018  
Individual/Entity: **Villas of West Ashley Condominium Owners Association, Inc.**  
Facility: Villas of West Ashley  
Location: 3526 Mary Ader Avenue  
Charleston, SC 29414  
Mailing Address: 124 #A Ashley Villa Circle  
Charleston, SC 29414  
County: Charleston  
Previous Orders: None  
Permit/ID Number: 10-1045B  
Violations Cited: S.C. Code Ann. Regs. 61-51(J)

Summary: Villas of West Ashley Condominium Owners Association, Inc. (Individual/Entity) owns and is responsible for the proper operation and maintenance of a pool. On May 18, 2018, and June 28, 2018, the pool was inspected, and a violation was issued for failure to properly operate and maintain. The Individual/Entity has violated the Public Swimming Pools Regulation as follows: a handrail was not tight and secure; a skimmer was missing a weir; the bathrooms were not accessible; there was no drinking water fountain; the chlorine and pH levels were not within the acceptable range of water quality standards; the main drain grate was not in place; the shepherd's crook was not permanently attached to the handle; and the bound and numbered log book was not maintained on a daily basis. On June 29, 2018, a follow-up inspection was conducted, and it was determined that all of the deficiencies had been addressed.

Action: The Individual/Entity is required to: pay a civil penalty in the amount of five hundred sixty dollars **(\$560.00)**.

66) Order Type and Number: Consent Order 18-132-RW  
Order Date: August 14, 2018  
Individual/Entity: **WMJ, LLC**  
Facility: Sea Dip Motel  
Location: 2608 North Ocean Boulevard  
Myrtle Beach, SC 29577  
Mailing Address: Same  
County: Horry

Previous Orders: 17-092-RW (26-Q21-1) (\$2,040.00);  
17-141-RW (26-D97-1) (\$2,040.00)  
Permit/ID Number: 26-Q21-1; 26-D97-1  
Violations Cited: S.C. Code Ann. Regs. 61-51(j)

Summary: WMJ, LLC (Individual/Entity) owns and is responsible for the proper operation and maintenance of two spas. On May 24, 2018, and June 21, 2018, the spas were inspected, and violations were issued for failure to properly operate and maintain. The Individual/Entity has violated the Public Swimming Pools Regulation as follows: skimmers were missing weirs; the chlorine and pH levels were not within the acceptable range of water quality standards; the cyanuric acid level was above the water quality standards acceptable limit; and the bound and numbered log book was not maintained on a daily basis.

Action: The Individual/Entity is required to: submit a corrective action plan and schedule implementation to address the deficiencies; and pay a civil penalty in the amount of two thousand, two hundred forty dollars (**\$2,240.00**). The civil penalty has been paid.

67) Order Type and Number: Consent Order 18-133-RW  
Order Date: August 14, 2018  
Individual/Entity: **Mid- America Apartment Communities, Inc.**  
Facility: Colonial Village at Hampton Pointe Apartments  
Location: 1916 Sam Rittenburg Boulevard  
Charleston, SC 29407  
Mailing Address: Same  
County: Charleston  
Previous Orders: 17-148-RW (\$680.00)  
Permit/ID Number: 10-361-1  
Violations Cited: S.C. Code Ann. Regs. 61-51(j)

Summary: Mid-America Apartment Communities, Inc. (Individual/Entity) owns and is responsible for the proper operation and maintenance of a pool. On May 25, 2018, and July 12, 2018, the pool was inspected, and a violation was issued for failure to properly operate and maintain. The Individual/Entity has violated the Public Swimming Pools Regulation as follows: the pool floor was dirty; the drinking water fountain was not operating; the chlorine level was not within the acceptable range of water quality standards; the life ring was deteriorated and did not have a permanently attached rope; the bound and numbered log book was not available for review on the first inspection; and the cyanuric acid level readings were not recorded weekly in the log book on the second inspection.

Action: The Individual/Entity is required to: submit a corrective action plan and schedule implementation to address the deficiencies; and pay a civil penalty in the amount of one thousand, three hundred sixty dollars (**\$1,360.00**). The Individual/Entity submitted a corrective action plan and corrected the deficiencies.

68) Order Type and Number: Consent Order 18-134-RW  
Order Date: August 14, 2018  
Individual/Entity: **Beaufort Lodging, LLC**  
Facility: Hampton Inn  
Location: 2342 Boundary Street  
Beaufort, SC 29902  
Mailing Address: 14901 Holiday Lane  
Cornelius, NC 28031

County: Beaufort  
Previous Orders: 16-115-RW (\$680.00)  
Permit/ID Number: 07-502-1  
Violations Cited: S.C. Code Ann. Regs. 61-51(J)

Summary: Beaufort Lodging, LLC (Individual/Entity) owns and is responsible for the proper operation and maintenance of a pool. On May 31, 2018, and June 27, 2018, the pool was inspected, and a violation was issued for failure to properly operate and maintain. The Individual/Entity has violated the Public Swimming Pools Regulation as follows: a ladder was missing bumpers and bolt covers; the chlorin level was not within the acceptable range of water quality standards; and the bound and numbered log book was not maintained on a daily basis.

Action: The Individual/Entity is required to: submit a corrective action plan and schedule implementation to address the deficiencies; and pay a civil penalty in the amount of one thousand, three hundred sixty dollars **(\$1,360.00)**.

69) Order Type and Number: Consent Order 18-135-RW  
Order Date: August 14, 2018  
Individual/Entity: **Piney Grove Investments, Inc.**  
Facility: Country Inn & Suites  
Location: 408 Piney Grove Road  
Columbia, SC 29206  
Mailing Address: Same  
County: Lexington  
Previous Orders: None  
Permit/ID Number: 32-1090D  
Violations Cited: S.C. Code Ann. Regs. 61-51(J)

Summary: Piney Grove Investments, Inc. (Individual/Entity) owns and is responsible for the proper operation and maintenance of a spa. On March 6, 2018, and June 5, 2018, the spa was inspected, and a violation was issued for failure to properly operate and maintain. The Individual/Entity has violated the Public Swimming Pools Regulation as follows: the drinking water fountain was not operating; there were chemicals stored in the pump room; the chlorine and pH levels were not within the acceptable range of water quality standards; the spa thermometer was broken and the spa temperature was not being recor on the spa rules sign; the pool equipment room piping was leaking; the spa temperature was above 104 degrees Fahrenheit; the bound and numbered log book was not maintained a minimum of three times p week by the pool operator of record; and the automatic controller was not working.

Action: The Individual/Entity is required to: submit a corrective action plan and schedule implementation to address the deficiencies; and pay a civil penalty in the amount of six hundred eighty dollars **(\$680.00)**. The civil penalty has been paid.

70) Order Type and Number: Consent Order 18-136-RW  
Order Date: August 15, 2018  
Individual/Entity: **Harbour View, LLC**  
Facility: Sleep Inn at Harbour View  
Location: 909 US-17 North  
Little River, SC 29566  
Mailing Address: P.O. Box 1117  
Myrtle Beach, SC 29578  
County: Horry

Previous Orders: None  
Permit/ID Number: 26-P82-1  
Violations Cited: S.C. Code Ann. Regs. 61-51(J)

Summary: Harbour View, LLC (Individual/Entity) owns and is responsible for the proper operation and maintenance of a pool. On June 12, 2018, and July 16, 2018, the pool was inspected, and a violation was issued for failure to properly operate and maintain. The Individual/Entity has violated the Public Swimming Pools Regulation as follows: a ladder was missing bumpers; a skimmer was missing a weir; a gate did not self-close and latch; the chlorine and pH levels were not within the acceptable range of water quality standards; the life ring did not have a permanently attached rope; the pool rules sign was not completely filled out; only one "Shallow Water - No Diving Allowed" sign was posted; the current pool operator of record information was not posted to the public; and the bound and numbered log book was not maintained on a daily basis.

Action: The Individual/Entity is required to: submit a corrective action plan and schedule implementation to address the deficiencies; and pay a civil penalty in the amount of five hundred sixty dollars (**\$560.00**). The civil penalty has been paid. The Individual/Entity submitted a corrective action plan and corrected the deficiencies.

71) Order Type and Number: Consent Order 18-137-RW  
Order Date: August 17, 2018  
Individual/Entity: **Royal Dunes Beach Villas at Port Royal Resort Owners Association, Inc.**  
Facility: Royal Dunes Resort  
Location: 8 Wimbledon Court  
Hilton Head, SC 29928  
Mailing Address: Same  
County: Beaufort  
Previous Orders: None  
Permit/ID Number: 07-456-1  
Violations Cited: S.C. Code Ann. Regs. 61-51(J)

Summary: Royal Dunes Beach Villas at Port Royal Resort Owners Association, Inc. (Individual/Entity) owns and is responsible for the proper operation and maintenance of a spa. On June 14, 2018, and July 13, 2018, the spa was inspected, and a violation was issued for failure to properly operate and maintain. The Individual/Entity has violated the Public Swimming Pools Regulation as follows: the chlorine and pH levels were not within the acceptable range of water quality standards; the cyanuric acid level was above the water quality standards acceptable limit; and the spa rules sign was not completely filled out.

Action: The Individual/Entity is required to: submit a corrective action plan and schedule implementation to address the deficiencies; and pay a civil penalty in the amount of six hundred eighty dollars (**\$680.00**).

72) Order Type and Number: Consent Order 18-138-RW  
Order Date: August 17, 2018  
Individual/Entity: **Waterford Apartment Complex Operating Company, LLC**  
Facility: Waterford Apartments  
Location: 1340 Longcreek Drive  
Columbia, SC 29210



Mailing Address: Same  
County: Richland  
Previous Orders: None  
Permit/ID Number: 40-218-1  
Violations Cited: S.C. Code Ann. Regs. 61-51(J)

Summary: Waterford Apartment Complex Operating Company, LLC (Individual/Entity) owns and is responsible for the proper operation and maintenance of a pool. On June 14, 2018, and July 10, 2018, the pool was inspected, and a violation was issued for failure to properly operate and maintain. The Individual/Entity has violated the Public Swimming Pools Regulation as follows: a handrail was not tight and secure; a skimmer was missing a weir; the fill spout was not made of stainless steel or equivalent; the facility address was not posted at the emergency notification device; the bound and numbered log book was not maintained on a daily basis; the chlorine level was not within the acceptable range of water quality standards; the cyanuric acid level was above the water quality standards acceptable limit; and the cyanuric acid level was not checked weekly.

Action: The Individual/Entity is required to: submit a corrective action plan and schedule implementation to address the deficiencies; and pay a civil penalty in the amount of six hundred eighty dollars **(\$680.00)**.

73) Order Type and Number: Consent Order 18-139-RW  
Order Date: August 20, 2018  
Individual/Entity: **Sunrise Hotels of Charleston, LLC**  
Facility: Comfort Inn Charleston  
Location: 144 Bee Street  
Charleston, SC 29401  
Mailing Address: Same  
County: Charleston  
Previous Orders: 14-070-DW (\$800.00);  
16-219-RW (\$1,360.00);  
18-055-RW (\$5,040.00)  
Permit/ID Number: 10-411-1  
Violations Cited: S.C. Code Ann. Regs. 61-51(J)

Summary: Sunrise Hotels of Charleston, LLC (Individual/Entity) owns and is responsible for the proper operation and maintenance of a pool. On May 29, 2018, and June 28, 2018, the pool was inspected and a violation was issued for failure to properly operate and maintain. The Individual/Entity has violated the Public Swimming Pools Regulation as follows: the chlorine level was not within the acceptable range of water quality standards; the pool rules sign was not completely filled out; and the bound and numbered log book was not maintained on a daily basis on both inspections, and was not maintained a minimum of three times per week by the pool operator of record on the second inspection.

Action: The Individual/Entity is required to: submit a corrective action plan and schedule implementation to address the deficiencies; and pay a civil penalty in the amount of four thousand, four hundred dollars **(\$4,400.00)**. The civil penalty has been paid.

74) Order Type and Number: Consent Order 18-140-RW  
Order Date: August 20, 2018  
Individual/Entity: **Carolina Fitness Group, LLC**  
Facility: Gold's Gym Rock Hill  
Location: 2182 Cherry Road

Mailing Address: Rock Hill, SC 29732  
P.O. Box 1522  
Albermarle, NC 28022  
County: York  
Previous Orders: None  
Permit/ID Number: 46-1141B; 46-1142D  
Violations Cited: S.C. Code Ann. Regs. 61-51(J)

Summary: Carolina Fitness Group, LLC (Individual/Entity) owns and is responsible for the proper operation and maintenance of a pool and a spa. On February 28, 2018, June 15, 2018, and July 13, 2018 the pool and spa were inspected, and violations were issued for failure to properly operate and maintain. The Individual/Entity has violated the Public Swimming Pools Regulation as follows: a skimmer was missing a weir; a handrail was not tight and secure; the chlorine and pH levels were not within the acceptable range of water quality standards; the bound and numbered log book was not maintained on a daily basis; the disinfection equipment was not operating properly; and the automatic controller was not operating properly.

Action: The Individual/Entity is required to: submit a corrective action plan and schedule implementation to address the deficiencies; and pay a civil penalty in the amount of four thousand, eight hundred dollars (**\$4,080.00**).

75) Order Type and Number: Consent Order 18-141-RW  
Order Date: August 22, 2018  
Individual/Entity: **9 Marina, LLC**  
Facility: Days Inn  
Location: 9 Marina Side Drive  
Hilton Head Island, SC 29928  
Mailing Address: 5625 FM 1960 Road West, Suite 500  
Houston, TX 77069  
County: Beaufort  
Previous Orders: 15-107-RW (\$680.00);  
16-141-RW (\$680.00)  
Permit/ID Number: 07-379-1  
Violations Cited: S.C. Code Ann. Regs. 61-51(J)

Summary: 9 Marina, LLC (Individual/Entity) owns and is responsible for the proper operation and maintenance of a pool. On June 5, 2018, and July 9, 2018, the pool was inspected, and a violation was issued for failure to properly operate and maintain. The Individual/Entity has violated the Public Swimming Pools Regulation as follows: a ladder was missing bumpers and bolt covers; a handrail was split and had sharp edges; the deck was uneven with sharp edges; the gate did not self-close and latch; the shepherd crook was not permanently attached to the handle; the chlorine level was not within the acceptable range of water quality standards; and the bound and numbered log book was not maintained on a daily basis.

Action: The Individual/Entity is required to: submit a corrective action plan and schedule implementation to address the deficiencies; and pay a civil penalty in the amount of two thousand, seven hundred twenty dollars (**\$2,720.00**). The civil penalty has been paid. The Individual/Entity submitted a corrective action plan and corrected the deficiencies.

76) Order Type and Number: Consent Order 18-142-RW  
Order Date: August 22, 2018  
Individual/Entity: **South Shores Homeowners Association, Inc.**  
Facility: South Shores I  
Location: 12 Avenue S  
Surfside Beach, SC 29577  
Mailing Address: Same  
County: Horry  
Previous Orders: None  
Permit/ID Number: 26-937-1  
Violations Cited: S.C. Code Ann. Regs. 61-51(J)

Summary: South Shores Homeowners Association, Inc. (Individual/Entity) owns and is responsible for the proper operation and maintenance of a pool. On June 14, 2018, the pool was inspected, and a violation was issued for failure to properly operate and maintain. The Individual/Entity has violated the Public Swimming Pools Regulation as follows: the lifeline floats were not properly spaced; skimmers were missing weirs; the chlorine and pH levels were not within the acceptable range of water quality standards; the cyanuric acid level was above the water quality standards acceptable limit; the pool rules sign was not completely filled out; only one "Shallow Water - No Diving Allowed" sign was posted; and the current pool operator of record information was not posted to the public.

Action: The Individual/Entity is required to: submit a corrective action plan and schedule implementation to address the deficiencies; and pay a civil penalty in the amount of three hundred forty dollars (**\$340.00**). The civil penalty has been paid. The Individual/Entity submitted a corrective action plan and corrected the deficiencies.

77) Order Type and Number: Consent Order 18-143-RW  
Order Date: August 22, 2018  
Individual/Entity: **Preserve at Spears Creek/H.P., L.L.C.**  
Facility: Preserve at Spears Creek  
Location: 325 Spears Creek Church Road  
Columbia, SC 29045  
Mailing Address: Same  
County: Richland  
Previous Orders: None  
Permit/ID Number: 40-1081B  
Violations Cited: S.C. Code Ann. Regs. 61-51(J)

Summary: Preserve at Spears Creek/H.P., L.L.C. (Individual/Entity) owns and is responsible for the proper operation and maintenance of a pool. On May 29, 2018, and July 10, 2018, the pool was inspected and a violation was issued for failure to properly operate and maintain. The Individual/Entity has violated the Public Swimming Pools Regulation as follows: a ladder was missing bumpers; a skimmer was missing a weir; the fill spout was not made of stainless steel or equivalent; the chlorine level was not within the acceptable range of water quality standards; the automatic controller was not operating properly; a bolt cover was not secure; some of the tiles on the pool wall were missing; a skimmer basket was not seated properly; there were non-pool related items stored in the equipment room; there were chemicals stored in the equipment room; the step edge tile stripe was not within one inch of the step edge and was missing front of the handrail; the cyanuric acid level was not checked weekly; and the bound and numbered log book was not maintained on a daily basis.

Action: The Individual/Entity is required to: submit a corrective action plan and schedule implementation to address the deficiencies; and pay a civil penalty in the amount of six hundred eighty dollars **(\$680.00)**.

78) Order Type and Number: Consent Order 18-144-RW  
Order Date: August 22, 2018  
Individual/Entity: **Twilight Surf Motel, LLC**  
Facility: Twilight Surf Motel  
Location: 1703 South Ocean Boulevard  
Myrtle Beach, SC 29577  
Mailing Address: Same  
County: Horry  
Previous Orders: 14-066-DW (\$800.00);  
18-018-RW (\$2,040.00)  
Permit/ID Number: 26-370-1  
Violations Cited: S.C. Code Ann. Regs. 61-51(J)

Summary: Twilight Surf Motel, LLC (Individual/Entity) owns and is responsible for the proper operation and maintenance of a pool. On May 31, 2018, and June 27, 2018, the pool was inspected, and a violation was issued for failure to properly operate and maintain. The Individual/Entity has violated the Public Swimming Pools Regulation as follows: the lifeline did not have the required number of floats and the floats were not properly spaced; a skimmer was missing a weir; there was no drinking water fountain there was no foot rinse shower; the gate did not self-close and latch; and the chlorine and pH levels were not within the acceptable range of water quality standards.

Action: The Individual/Entity is required to: submit a corrective action plan and schedule implementation to address the deficiencies; and pay a civil penalty in the amount of two thousand, seven hundred twenty dollars **(\$2,720.00)**.

79) Order Type and Number: Consent Order 18-145-RW  
Order Date: August 22, 2018  
Individual/Entity: **Abi KOA Fort Mill, LLC**  
Facility: Charlotte Fort Mill KOA  
Location: 940 Gold Hill Road  
Fort Mill, SC 29708  
Mailing Address: Same  
County: York  
Previous Orders: None  
Permit/ID Number: 46-033-1  
Violations Cited: S.C. Code Ann. Regs. 61-51(J)

Summary: Abi KOA Fort Mill, LLC (Individual/Entity) owns and is responsible for the proper operation and maintenance of a pool. On June 12, 2018, and July 13, 2018, the pool was inspected, and a violation was issued for failure to properly operate and maintain. The Individual/Entity has violated the Public Swimming Pools Regulation as follows: the lifeline floats were not properly spaced; a ladder was missing bumpers; the water level was too high; there was no foot rinse shower; a gate did not self-close and latch; the main drain grates were not visible due to cloudy water; the shepherd's crook was missing bolt; and the bound and numbered log book was not available for review on the first inspection, and was not maintained on a daily basis on the second inspection.

Action: The Individual/Entity is required to: submit a corrective action plan and schedule implementation to address the deficiencies; and pay a civil penalty in the amount of six hundred eighty dollars (**\$680.00**). The civil penalty has been paid.

80) Order Type and Number: Consent Order 18-146-RW  
Order Date: August 22, 2018  
Individual/Entity: **Landmark Homeowners' Association, Inc.**  
Facility: Landmark Resort  
Location: 1501 South Ocean Boulevard  
Myrtle Beach, SC 29577  
Mailing Address: 4615 Oleander Dr., Suite 202  
Myrtle Beach, SC 29577  
County: Horry  
Previous Orders: None  
Permit/ID Number: 26-L41-1, 26-L44-1  
Violations Cited: S.C. Code Ann. Regs. 61-51(J)

Summary: Landmark Homeowners' Association, Inc. (Individual/Entity) owns and is responsible for the proper operation and maintenance of a pool and a kiddie pool. On March 5, 2018, and May 23, 2018 the pool and kiddie pool were inspected and violations were issued for failure to properly operate and maintain; on June 29, 2018, the pool was inspected and a violation was issued for failure to properly operate and maintain; and on July 9, 2018, the pool and kiddie pool were inspected and violations were issued for failure to properly operate and maintain. The Individual/Entity has violated the Public Swimming Pools Regulation as follows: a skimmer was missing a weir; a gate did not self-close and latch; the chlorine and pH levels were not within the acceptable range of water quality standards; a main drain grate was broken; only one "No Lifeguard On Duty - Swim At Your Own Risk" sign was posted; and the bound and numbered log book was not maintained on a daily basis.

Action: The Individual/Entity is required to: submit a corrective action plan and schedule implementation to address the deficiencies; and pay a civil penalty in the amount of four thousand, eight hundred dollars (**\$4,080.00**).

81) Order Type and Number: Consent Order 18-147-RW  
Order Date: August 22, 2018  
Individual/Entity: **Beach Club at Montego Inn Homeowners Association, Inc.**  
Facility: Beach Club at Montego Inn  
Location: 1307 South Ocean Boulevard  
Myrtle Beach, SC 29577  
Mailing Address: Same  
County: Horry  
Previous Orders: None  
Permit/ID Number: 26-H76-1  
Violations Cited: S.C. Code Ann. Regs. 61-51(J)

Summary: Beach Club at Montego Inn Homeowners Association, Inc. (Individual/Entity) owns and is responsible for the proper operation and maintenance of a pool. On May 29, 2018, and June 27, 2018, the pool was inspected, and a violation was issued for failure to properly operate and maintain. Individual/Entity has violated the Public Swimming Pools Regulation as follows: a skimmer was missing a weir; the gate did not self-close and latch; the bound and numbered log book was not available for review.

the chlorine level was not within the acceptable range of water quality standards; and the current pool operator of record information was not posted to the public.

Action: The Individual/Entity is required to: submit a corrective action plan and schedule implementation to address the deficiencies; and pay a civil penalty in the amount of six hundred eighty dollars **(\$680.00)**.

82) Order Type and Number: Consent Order 18-148-RW  
Order Date: August 27, 2018  
Individual/Entity: **Sawmill Forest Owners' Association, Inc.**  
Facility: Sawmill Forest  
Location: 1 Sawmill Forest Drive  
Bluffton, SC 29910  
Mailing Address: P.O. Box 7665  
Hilton Head Island, SC 29938  
County: Beaufort  
Previous Orders: None  
Permit/ID Number: 07-519-1  
Violations Cited: S.C. Code Ann. Regs. 61-51(J)

Summary: Sawmill Forest Owners' Association, Inc. (Individual/Entity) owns and is responsible for the proper operation and maintenance of a pool. On June 11, 2018, and July 18, 2018, the pool was inspected, and a violation was issued for failure to properly operate and maintain. The Individual/Entity has violated the Public Swimming Pools Regulation as follows: the chlorine and pH levels were not within the acceptable range of water quality standards.

Action: The Individual/Entity is required to: submit a corrective action plan and schedule implementation to address the deficiencies; and pay a civil penalty in the amount of six hundred eighty dollars **(\$680.00)**. The civil penalty has been paid.

83) Order Type and Number: Consent Order 18-149-RW  
Order Date: August 27, 2018  
Individual/Entity: **Mariner Hotel, LLC**  
Facility: Mariner Hotel  
Location: 7003 North Ocean Boulevard  
Myrtle Beach, SC 29572  
Mailing Address: Same  
County: Horry  
Previous Orders: None  
Permit/ID Number: 26-153-1  
Violations Cited: S.C. Code Ann. Regs. 61-51(J)

Summary: Mariner Hotel, LLC (Individual/Entity) owns and is responsible for the proper operation and maintenance of a pool. On May 30, 2018, and June 21, 2018, the pool was inspected, and a violation was issued for failure to properly operate and maintain. The Individual/Entity has violated the Public Swimming Pools Regulation as follows: a skimmer was missing a weir; the bound and numbered log book was not maintained on a daily basis; a skimmer lid was cracked; the chlorine level was not within the acceptable range of water quality standards; and the facility address was not posted at the emergency notification device. On August 8, 2018, a follow-up inspection was conducted, and it was determined that all of the deficiencies had been addressed.

Action: The Individual/Entity is required to: pay a civil penalty in the amount of five hundred sixty dollars (**\$560.00**). The civil penalty has been paid.

84) Order Type and Number: Consent Order 18-150-RW  
Order Date: August 27, 2018  
Individual/Entity: **Walterboro Hospitality, LLC**  
Facility: Baymont Inn & Suites  
Location: 1286 Sniders Highway  
Walterboro, SC 29488  
Mailing Address: Same  
County: Colleton  
Previous Orders: None  
Permit/ID Number: 15-008-1  
Violations Cited: S.C. Code Ann. Regs. 61-51(J)(10)

Summary: Walterboro Hospitality, LLC (Individual/Entity) owns and is responsible for the proper operation and maintenance of a pool. On July 12, 2018, the Department learned of an accidental drowning that occurred at the pool on July 7, 2018 and visited the pool to notify the Individual/Entity of the violation for failure to report the drowning to the Department. The Individual/Entity has violated the Public Swimming Pools Regulation as follows: failed to report to the Department in writing, on a Department approved form, any death, injury, or accident requiring an EMS response, emergency room visit, or hospitalization within seventy-two hours of the occurrence.

Action: The Individual/Entity is required to: pay a civil penalty in the amount of three hundred forty dollars (**\$340.00**). The civil penalty has been paid.

85) Order Type and Number: Consent Order 18-151-RW  
Order Date: August 28, 2018  
Individual/Entity: **4PR, Inc.**  
Facility: Best Western Patriots Point  
Location: 259 Magrath Darby Boulevard  
Mount Pleasant, SC 29464  
Mailing Address: Same  
County: Charleston  
Previous Orders: None  
Permit/ID Number: 10-569-1  
Violations Cited: S.C. Code Ann. Regs. 61-51(J)

Summary: 4PR, Inc. (Individual/Entity) owns and is responsible for the proper operation and maintenance of a pool. On May 30, 2018, and June 29, 2018, the pool was inspected, and a violation was issued for failure to properly operate and maintain. The Individual/Entity has violated the Public Swimming Pools Regulation as follows: the chlorine level was not within the acceptable range of water quality standards; the cyanuric acid level was above the water quality standards acceptable limit; the life ring was deteriorated; there was no pool rules sign on the first inspection and the pool rules sign was not completely filled out on the second inspection; only one "Shallow Water - No Diving Allowed" sign was posted; only one "No Lifeguard On Duty - Swim At Your Own Risk" sign was posted; and the bound and numbered log book was not maintained on a daily basis.

Action: The Individual/Entity is required to: submit a corrective action plan and schedule implementation to address the deficiencies; and pay a civil penalty in the amount of six hundred eighty dollars (**\$680.00**). The civil penalty has been paid.

86) Order Type and Number: Consent Order 18-152-RW  
Order Date: August 28, 2018  
Individual/Entity: **Broad Creek Landing Horizontal Property Regime, Inc.**  
Facility: Broad Creek Landing Forest Cove  
Location: Broad Creek Landing Drive  
Hilton Head Island, SC 29928  
Mailing Address: 40 Point Comfort Road  
Hilton Head Island, SC 29928  
County: Beaufort  
Previous Orders: None  
Permit/ID Number: 07-319-1  
Violations Cited: S.C. Code Ann. Regs. 61-51(J)

Summary: Broad Creek Landing Horizontal Property Regime, Inc. (Individual/Entity) owns and is responsible for the proper operation and maintenance of a pool. On June 15, 2018, and July 16, 2018, the pool was inspected, and a violation was issued for failure to properly operate and maintain. The Individual/Entity has violated the Public Swimming Pools Regulation as follows: a handrail was missing a bolt cover; a bathroom light did not work; the emergency notification device was not operational; and the facility address was not posted at the emergency notification device.

Action: The Individual/Entity is required to: submit a corrective action plan and schedule implementation to address the deficiencies; and pay a civil penalty in the amount of six hundred eighty dollars (**\$680.00**). The Individual/Entity submitted a corrective action plan and corrected the deficiencies.

87) Order Type and Number: Consent Order 18-153-RW  
Order Date: August 30, 2018  
Individual/Entity: **Sea Mystique Homeowners of Garden City, Inc.**  
Facility: Sea Mystique  
Location: #1 Fawn Vista Drive  
Garden City, SC 29576  
Mailing Address: Same  
County: Horry  
Previous Orders: None  
Permit/ID Number: 26-952-1  
Violations Cited: S.C. Code Ann. Regs. 61-51(J)

Summary: Sea Mystique Homeowners of Garden City, Inc. (Individual/Entity) owns and is responsible for the proper operation and maintenance of a pool. On June 19, 2018, and July 30, 2018, the pool was inspected, and a violation was issued for failure to properly operate and maintain. The Individual/Entity has violated the Public Swimming Pools Regulation as follows: a ladder was missing bumpers; a skimmer was missing a weir; the chlorine and pH levels were not within the acceptable range of water quality standards; the emergency notification device was not operational; the pool rules sign was not completely filled out; and the current pool operator of record information was not posted to the public

Action: The Individual/Entity is required to: submit a corrective action plan and schedule implementation to address the deficiencies; and pay a civil penalty in the amount of six hundred eighty dollars (**\$680.00**). The civil penalty has been paid. The Individual/Entity submitted a corrective action plan and corrected the deficiencies.



88) Order Type and Number: Consent Order 18-154-RW  
Order Date: August 31, 2018  
Individual/Entity: **Wyndham Vacation Resorts, Inc.**  
Facility: Wyndham Village  
Location: 1 King Cotton Road  
Edisto Island, SC 29438  
Mailing Address: Same  
County: Colleton  
Previous Orders: 13-154-DW (\$800.00);  
14-190-DW (\$1,600.00)  
Permit/ID Number: 15-1005D  
Violations Cited: S.C. Code Ann. Regs. 61-51(J)

Summary: Wyndham Vacation Resorts, Inc. (Individual/Entity) owns and is responsible for the proper operation and maintenance of a spa. On May 30, 2018, and July 18, 2018, the spa was inspected, and a violation was issued for failure to properly operate and maintain. The Individual/Entity has violated the Public Swimming Pools Regulation as follows: the drinking water fountain was not operating properly; the chlorine level was not within the acceptable range of water quality standards; the cyanuric acid level was above the water quality standards acceptable limit; there was no thermometer in the spa; and the bound and numbered log book was not maintained on a daily basis.

Action: The Individual/Entity is required to: submit a corrective action plan and schedule implementation to address the deficiencies; and pay a civil penalty in the amount of two thousand, seven hundred twenty dollars **(\$2,720.00)**. The Individual/Entity submitted a corrective action plan and corrected the deficiencies.

89) Order Type and Number: Consent Order 18-155-RW  
Order Date: August 31, 2018  
Individual/Entity: **Shivam Investments, Inc.**  
Facility: Country Inn & Suites  
Location: 200 East Exchange Boulevard  
Columbia, SC 29209  
Mailing Address: Same  
County: Richland  
Previous Orders: 16-027-RW, \$340.00  
Permit/ID Number: 40-394-1 & 40-395-1  
Violations Cited: S.C. Code Ann. Regs. 61-51(J)

Summary: Shivam Investments, Inc. (Individual/Entity) owns and is responsible for the proper operation and maintenance of a pool and a spa. On March 12, 2018, and June 4, 2018, the pool and spa were inspected, and violations were issued for failure to properly operate and maintain. The Individual/Entity has violated the Public Swimming Pools Regulation as follows: the cyanuric acid level was above the water quality standards acceptable limit; the bound and numbered log book was not available for review on the first inspection, and was not maintained on a daily basis on the second inspection; the chlorine and pH levels were not within the acceptable range of water quality standards; the time and temperature were not being recorded on the spa caution sign; a ladder was missing a step tread; and the facility address was not posted at the emergency notification device.

Action: The Individual/Entity is required to: submit a corrective action plan and schedule implementation to address the deficiencies; and pay a civil penalty in the amount of two thousand, forty dollars **(\$2,040.00)**.

90) Order Type and Number: Consent Order 18-156-RW  
Order Date: August 31, 2018  
Individual/Entity: **Bolton Landing Apartments, LLC**  
Facility: Bolton Landing Apartments  
Location: 1450 Bluewater Way  
Charleston, SC 29414  
Mailing Address: Same  
County: Charleston  
Previous Orders: 16-131-RW (\$680.00)  
Permit/ID Number: 10-1184B  
Violations Cited: S.C. Code Ann. Regs. 61-51(J)

Summary: Bolton Landing Apartments, LLC (Individual/Entity) owns and is responsible for the proper operation and maintenance of a pool. On May 18, 2018, and June 27, 2018, the pool was inspected and a violation was issued for failure to properly operate and maintain. The Individual/Entity has violated the Public Swimming Pools Regulation as follows: a ladder was missing; a ladder was missing a bumper; the pool walls were dirty; a skimmer was missing a weir; the drinking water fountain was not operating; the pool rules sign did not have all of the required rules; the bound and numbered log book was not maintained on a daily basis; a ladder was missing non-slip tread inserts; and the chlorine level was not within the acceptable range of water quality standards.

Action: The Individual/Entity is required to: submit a corrective action plan and schedule implementation to address the deficiencies; and pay a civil penalty in the amount of one thousand, three hundred sixty dollars (**\$1,360.00**). The civil penalty has been paid.

91) Order Type and Number: Consent Order 18-157-RW  
Order Date: August 31, 2018  
Individual/Entity: **Willow Lake Homeowner's Association, Inc.**  
Facility: Willow Lake  
Location: North High Duck Trail  
Blythewood, SC 29016  
Mailing Address: 1320 Main Street, Suite 300  
Columbia, SC 29201  
County: Richland  
Previous Orders: None  
Permit/ID Number: 40-343-1 & 40-344-1  
Violations Cited: S.C. Code Ann. Regs. 61-51(J)

Summary: Willow Lake Homeowner's Association, Inc. (Individual/Entity) owns and is responsible for the proper operation and maintenance of a pool and a kiddie pool. On May 30, 2018, and July 2, 2018, the pool and kiddie pool were inspected, and violations were issued for failure to properly operate and maintain. The Individual/Entity has violated the Public Swimming Pools Regulation as follows: a handrail was not tight and secure; a ladder was not tight and secure; a skimmer was missing a weir; the drinking water fountain and the foot rinse shower were not operating; there was no grate over the backwash pit; there was no chemical storage room and bleach barrels were stored outside; there were non-pool related items stored in the pool equipment room; the pool equipment room piping was leaking; the gate did not self-close and latch; a weir was stuck; the Vac-Alert certification was missing; the chlorine level was not within the acceptable range of water quality standards; there were chlorine sticks in the skimmer basket; a bolt cover was in disrepair; the deck was uneven with sharp edges; the bound and numbered log book was missing weekly cyanuric acid readings; and the water quality testing reagents were out of date.

Action: The Individual/Entity is required to: submit a corrective action plan and schedule implementation to address the deficiencies; and pay a civil penalty in the amount of one thousand, three hundred sixty dollars (**\$1,360.00**).

92) Order Type and Number: Consent Order 18-158-RW  
Order Date: August 31, 2018  
Individual/Entity: **Florence Lodging, Inc.**  
Facility: Sleep Inn  
Location: 1833 Florence Park Drive  
Florence, SC 29501  
Mailing Address: Same  
County: Florence  
Previous Orders: None  
Permit/ID Number: 21-124-1  
Violations Cited: S.C. Code Ann. Regs. 61-51(J)

Summary: Florence Lodging, Inc. (Individual/Entity) owns and is responsible for the proper operation and maintenance of a pool. On July 16, 2018, and August 10, 2018, the pool was inspected, and a violation was issued for failure to properly operate and maintain. The Individual/Entity has violated the Public Swimming Pools Regulation as follows: the pool floor was dirty; the pool furniture was not at least four feet from the edge of the pool; the drinking water fountain and foot rinse shower were not operating properly; the chlorine level was not within the acceptable range of water quality standards, the cyanuric acid level was above the water quality standards acceptable limit; the shepherd's crook was not approved length; the pool rules sign was damaged on the first inspection, and the pool rules sign was not completely filled out and did not have all of the required rules on the second inspection; there were no "Shallow Water - No Diving Allowed" signs posted on the first inspection, and both of the "Shallow Water - No Diving Allowed" signs did not have the correct wording or the correct size lettering on the second inspection; and the bound and numbered log book was not maintained on a daily basis.

Action: The Individual/Entity is required to: submit a corrective action plan and schedule implementation to address the deficiencies; and pay a civil penalty in the amount of six hundred eighty dollars (**\$680.00**). The civil penalty has been paid.

### **Drinking Water Enforcement**

93) Order Type and Number: Consent Order 18-019-DW  
Order Date: June 6, 2018  
Individual/Entity: **Sati Maa, LLC**  
Facility: Blythewood Stop N Shop  
Location: 10447 Wilson Blvd.  
Blythewood, SC 29016  
Mailing Address: Same  
County: Richland  
Previous Orders: None  
Permit/ID Number: 4070914  
Violations Cited: S.C. Code Ann. Regs. 61-58.7

Summary: Sati Maa, LLC (Individual/Entity) owns and is responsible for the proper operation and maintenance of a public water system (PWS). On March 19, 2018, the PWS was inspected and rated unsatisfactory for failure to properly operate and maintain. The Individual/Entity has violated the State

Primary Drinking Water Regulation as follows: the well did not have a screened air vent; the electrical wiring was not in conduit; the concrete well pad was severely cracked; there was open space around the casing that appeared to extend through the concrete well pad; there was no housing for the bladder tank; there was no housing for the well; there was no check valve; there were holes drilled into the sanitary seal; there was a capped pipe directly above the seal; there was no pressure gauge; the valve maintenance records were not available for review; the flushing records were not available for review; the leak detect and repair records were not available for review; there was no emergency preparedness plan available for review; and there was no procedures manual available for review.

Action: The Individual/Entity is required to: submit a corrective action plan with a schedule to correct the deficiencies; and pay a **stipulated penalty** in the amount of four thousand dollars (**\$4,000.00**), should any requirement of the Order not be met.

94) Order Type and Number: Consent Order 18-020-DW  
Order Date: July 18, 2018  
Individual/Entity: **Inflorescence, Inc.**  
Facility: Felicity's Flowers and Design  
Location: 649 Bennetts Bridge Road  
Greer, SC 29651  
Mailing Address: 8595 Pelham Road, Suite 400  
Greenville, SC 29615  
County: Spartanburg  
Previous Orders: None  
Permit/ID Number: 4270909  
Violations Cited: S.C. Code Ann. Regs. 61-58.17.K(1)

Summary: Inflorescence, Inc. (Individual/Entity) owns and is responsible for the proper operation and maintenance of a public water system (PWS). On June 15, 2018, a violation was issued as a result of review of monitoring records. The Individual/Entity has violated the State Primary Drinking Water Regulations as follows: the PWS tested present for total coliform and E. coli, which resulted in a violation of the maximum contaminant level (MCL) for E. coli.

Action: The Individual/Entity is required to: submit a corrective action plan to include proposed steps to address the MCL violation; and pay a **stipulated penalty** in the amount of four thousand dollars (**\$4,000.00**), should any requirement of the Order not be met.

95) Order Type and Number: Consent Order 18-021-DW  
Order Date: July 25, 2018  
Individual/Entity: **Richard McNeil, Individually and d.b.a. Richie's Deli**  
Facility: Richie's Deli  
Location: 4249 Highway 41  
Huger, SC 29450  
Mailing Address: Same  
County: Berkeley  
Previous Orders: None  
Permit/ID Number: 0872018  
Violations Cited: S.C. Code Ann. Regs. 61-58.17.K(2)(a) & 61-30.G(2)(a)

Summary: Richard McNeil, Individually and d.b.a. Richie's Deli (Individual/Entity) owns and responsible for the proper operation and maintenance of a public water system (PWS). On May 9, 2018,

a violation was issued as a result of review of Department records. The Individual/Entity has violated the State Primary Drinking Water Regulations as follows: failed to conduct the required corrective actions from a Level 2 Assessment following total coliform present sampling results, which resulted in a treatment technique violation; and failed to pay the annual Safe Drinking Water Act fee for fiscal Year 2017.

Action: The Individual/Entity is required to: submit a corrective action plan to include proposed steps to address the causes of the total coliform present sample results; pay the annual Safe Drinking Water Act fee for fiscal year 2017, which totals three hundred seventy-eight dollars and thirteen cents (\$378.13); and pay a **stipulated penalty** in the amount of four thousand dollars **(\$4,000.00)** should any requirement of the Order not be met.

96) Order Type and Number: Consent Order 18-022-DW  
Order Date: July 25, 2018  
Individual/Entity: **Chester Metropolitan District**  
Facility: Same  
Location: 6144 Lancaster Highway  
Fort Lawn, SC 29706  
Mailing Address: P.O. Box 550  
Chester, SC 29706  
County: Chester  
Previous Orders: None  
Permit/ID Number: 1220002  
Violations Cited: S.C. Code Ann. Regs. 61-58(B)(1)

Summary: Chester Metropolitan District (Individual/Entity) owns and is responsible for the proper operation and maintenance of a public water system (PWS). On June 12, 2018, Department staff conducted an inspection at the PWS and it was determined that a lime slurry feed treatment system had been installed and a permit to construct had not been issued by the Department. The Individual/Entity has violated the State Primary Drinking Water Regulation as follows: failed to obtain a permit to construct from Department prior to the modification of the PWS.

Action: The Individual/Entity is required to: submit a permit application and obtain a construction permit for the lime slurry feed treatment system; submit a standard operating procedure for ensuring that all future permitting requirements are complied with; and pay a civil penalty in the amount of four thousand dollars **(\$4,000.00)**.

97) Order Type and Number: Consent Order 18-023-DW  
Order Date: August 7, 2018  
Individual/Entity: **Ranch Road Water**  
Facility: Ranch Road Water  
Location: 671 Smith Road  
Laurens, SC 29360  
Mailing Address: Same  
County: Laurens  
Previous Orders: None  
Permit/ID Number: 3050008  
Violations Cited: S.C. Code Ann. Regs. 61-58.17.K(1)(b)

Summary: Ranch Road Water (Individual/Entity) owns and is responsible for the proper operation and maintenance of a public water system (PWS). On June 14, 2018, a violation was issued as a result of review of monitoring records. The Individual/Entity has violated the State Primary Drinking Water

Regulation as follows: the PWS tested present for total coliform and E. coli, which resulted in a violation of the maximum contaminant level (MCL) for E. coli.

Action: The Individual/Entity is required to: submit a corrective action plan to include proposed steps to address the MCL violation; and pay a **stipulated penalty** in the amount of four thousand dollars **(\$4,000.00)** should any requirement of the Order not be met.

98) Order Type and Number: Consent Order 18-024-DW  
Order Date: August 14, 2018  
Individual/Entity: **Saluda County Water & Sewer Authority**  
Facility: Saluda County Water & Sewer Authority  
Location: 106 North Jennings Street  
Saluda, SC 29138  
Mailing Address: Same  
County: Saluda  
Previous Orders: None  
Permit/ID Number: 4120001  
Violations Cited: S.C. Code Ann. Regs. 61-58.17.K(1)

Summary: Saluda County Water & Sewer Authority (Individual/Entity) owns and is responsible for the proper operation and maintenance of a public water system (PWS). On June 27, 2018, a violation was issued as a result of review of monitoring records. The Individual/Entity has violated the State Primary Drinking Water Regulation as follows: the PWS exceeded the maximum contaminant level (MCL) for total trihalomethanes.

Action: The Individual/Entity is required to: submit a corrective action plan to include proposed steps to address the MCL violation; and pay a **stipulated penalty** in the amount of four thousand dollars **(\$4,000.00)** should any requirement of the Order not be met.

99) Order Type and Number: Consent Order 18-025-DW  
Order Date: August 14, 2018  
Individual/Entity: **R&S Lakeview Park, LLC**  
Facility: R&S Lakeview Park  
Location: 33 Twin Rivers Road  
Waterloo, SC 29384  
Mailing Address: Same  
County: Laurens  
Previous Orders: None  
Permit/ID Number: 3060005  
Violations Cited: S.C. Code Ann. Regs. 61-58.17.K(2)(a)

Summary: R&S Lakeview Park, LLC (Individual/Entity) owns and is responsible for the proper operation and maintenance of a public water system (PWS). On July 3, 2018, a violation was issued as a result of review of Department records. The Individual/Entity has violated the State Primary Drinking Water Regulation as follows: failed to conduct a Level 2 Assessment by a party approved by the Department following a Level 2 treatment technique trigger, which resulted in a treatment technique violation.

Action: The Individual/Entity is required to: have a Level 2 Assessment conducted at the PWS by a party approved by the Department and submit the Assessment to the Department; submit a corrective action plan and a schedule to address the deficiencies documented on the Level 2 Assessment; pay a civil

penalty in the amount of two thousand dollars (**\$2,000.00**); and pay a stipulated penalty in the amount of two thousand dollars (\$2,000.00) should any requirement of the Order not be met.

100) Order Type and Number: Consent Order 18-026-DW  
Order Date: August 14, 2018  
Individual/Entity: **Town of Latta**  
Facility: Town of Latta  
Location: 107 NW Railroad Avenue  
Latta, SC 29565  
Mailing Address: Same  
County: Dillon  
Previous Orders: None  
Permit/ID Number: 1710002  
Violations Cited: S.C. Code Ann. Regs. 61-58.7

Summary: The Town of Latta (Individual/Entity) owns and is responsible for the proper operation and maintenance of a public water system (PWS). On June 11, 2018, the PWS was inspected and rated unsatisfactory for failure to properly operate and maintain. The Individual/Entity has violated the State Primary Drinking Water Regulation as follows: there were galvanized water lines that were causing discolored water; fire flow testing had not been completed; system valves had not been located or mapped; a flushing program had not been developed; the PWS was not adequately staffed to manage the leak detection and repair program; a water audit had not been completed and utilized to make improvements to the PWS; the system map of the PWS had not been completed to include the wells, water plants, water storage tanks, valves, hydrants, line locations, and line sizes; there was a leak at the Diversified Plastics elevated water storage tank between the riser and the bowl; the recommendations in the April 2017 Diversified Plastics and Industrial Park elevated water storage tank inspection report documented deficiencies that had not been addressed; the sample siting plan for the PWS had not been updated to reflect the changes in the Revised Total Coliform Rule; and deficiencies from previous surveys had not been addressed.

Action: The Individual/Entity is required to: submit a corrective action plan with a schedule to correct the deficiencies; submit an SOP for exercising valves; submit a written request of the intended use of two out-of-service wells; pay a civil penalty in the amount of two thousand dollars (**\$2,000.00**); and pay a stipulated penalty in the amount of two thousand dollars (\$2,000.00) should any requirement of the Order not be met.

### **Water Pollution Enforcement**

101) Order Type and Number: Consent Order 18-016-W  
Order Date: June 1, 2018  
Individual/Entity: **King Real Estate Holdings LP**  
Facility: Groves on the Ridge  
Location: Arrowhead Drive  
Pickens, SC  
Mailing Address: 217 Pinedale Road  
Liberty, SC 29657  
County: Pickens  
Previous Orders: None  
Permit/ID Number: SC0023141

Violations Cited: S.C. Code Ann. § 48-1-110(d) (Supp. 2016): 24 S.C. Code Ann. Regs. 61-9.122.41 (d)(2016).

Summary: King Real Estate Holdings LP (Individual/Entity) owns and is responsible for the proper operation and maintenance of a wastewater treatment facility located in Pickens County, South Carolina. On February 3, 2016, September 13, 2016, December 9, 2016, and May 24, 2017, Notices of Violation were issued to the Individual/Entity for failure to comply with the reporting requirements of its National Pollutant Discharge Elimination System (NPDES) permit. On March 23, 2017, a Notice of Violation was issued to the Individual/Entity for failure to comply with the effluent limits for biochemical oxygen demand (BOD) and Coliforms specified in its NPDES permit. The Individual/Entity has violated the Pollution Control Act and Water Pollution Control Permits Regulation as follows: failed to comply with the reporting requirements in the National Pollutant Discharge Elimination System (NPDES) permit; and, failed to comply with the effluent limits for BOD and Coliforms specified in its NPDES permit.

Action: The Individual/Entity is required to: submit a corrective action plan to address the deficiencies; and, pay a civil penalty in the amount of six thousand, eight hundred dollars (**\$6,800.00**).

102) Order Type and Number: Consent Order 18-017-W  
Order Date: June 1, 2018  
Individual/Entity: **City of Lancaster**  
Facility: City of Lancaster WWTF  
Location: Lockwood Lane  
Lancaster, SC  
Mailing Address: P.O. Box 1149  
Lancaster, SC 29721  
County: Lancaster  
Previous Orders: 15-040-W (\$8,125.00)  
Permit/ID Number: SC0046892  
Violations Cited: Pollution Control Act, S.C Code Ann § 48-1- 110 (d) (Supp. 2016); Water Pollution Control Permits, 3 S.C. Code Ann Regs. 61-9.122.41 (a) and (d) (2016).

Summary: City of Lancaster (Individual/Entity) owns and is responsible for the proper operation and maintenance of a wastewater treatment facility (WWTF) located in Lancaster County, South Carolina. On March 14, 2018, a Notice of Violation was issued for violations of the permitted discharge limits for E. coli as reported on discharge monitoring reports submitted to the Department. The Individual/Entity has violated the Pollution Control Act and Water Pollution Control Permits Regulation as follows: failed to comply with the effluent discharge limits for Coliforms specified in its National Pollutant Discharge Elimination System permit

Action: The Individual/Entity is required to: submit a corrective action plan to address the deficiencies; and, pay a civil penalty in the amount of three thousand, four hundred dollars (**\$3,400.00**).

103) Order Type and Number: Consent Order 18-018-W  
Order Date: June 6, 2018  
Individual/Entity: **McAfee Mobile Home Park**  
Facility: Wastewater Treatment Facility  
Location: 600 feet past the end of McAfee Court  
York County, SC  
Mailing Address: 1548 Fieldwood Drive  
Fort Mill, SC 29708  
County: York



Previous Orders: None  
Permit/ID Number: SC0027111  
Violations Cited: S.C. Code Ann. § 48-1-110(d) (Supp. 2016): 24 S.C. Code Ann. Regs. 61-9.122.41(d) and (l)(4) (2016).

Summary: McAfee Mobile Home Park (Individual/Entity) owns and is responsible for the proper operation and maintenance of a wastewater treatment facility located in York County, South Carolina. On April 3, 2016, April 20, 2016, and September 12, 2017, Notices of Violation were issued for failure to comply with the reporting requirements in its National Pollutant Discharge Elimination System (NPDES) permit. On March 23, 2017 a Notice of Violation was issued for failure to comply with the effluent limits in the NPDES permit. The Individual/Entity has violated the Pollution Control Act and Water Pollution Control Permits Regulation as follows: failed to comply with the reporting requirements of its NPDES permit; and, failed to comply with the effluent limits for COb's specified in its NPDES Permit.

Action: The Individual/Entity is required to: submit a corrective action plan to correct the deficiencies; and, pay a civil penalty in the amount of five thousand dollars **(\$5,000.00)**.

104) Order Type and Number: Consent Order 18-019-W  
Order Date: June 6, 2018  
Individual/Entity: **Giant Cement Company**  
Facility: Harleyville Plant  
Location: 654 Judge Street  
Harleyville, SC  
Mailing Address: P.O. Box 218  
Harleyville, SC 29448  
County: Dorchester  
Previous Orders: None  
Permit/ID Number: SC0022667  
Violations Cited: S.C. Code Ann. § 48-1-110(d) (Supp. 2016): 24 S.C. Code Ann. Regs. 61-9.122.41 (d)(2016).

Summary: Giant Cement Company (Individual/Entity) owns and is responsible for the proper operation and maintenance of a wastewater treatment facility located in Dorchester County, South Carolina. On February 15, 2017, and June 27, 2017, Notices of Violation were issued for failure to comply with the effluent limits in its National Pollutant Discharge Elimination System (NPDES) permit. The Individual/Entity has violated the Pollution Control Act and Water Pollution Control Permits Regulation as follows: failed to comply with the effluent discharge limits for Whole Effluent Chronic Toxicity (CTOX) and Selenium as specified in its National Pollutant Discharge Elimination System permit.

Action: The Individual/Entity is required to: monitor effluent as prescribed by the NPDES permit and submit a corrective action plan to address the deficiencies and potential enhancements to treatment processes if a violation of either CTOX or Selenium occurs within six (6) months; and, pay a civil penalty in the amount of six thousand dollars **(\$6,000.00)**.

105) Order Type and Number: Consent Order 18-020-W  
Order Date: June 13, 2018  
Individual/Entity: **Aiken County Public School District**  
Facility: Silver Bluff High School WWTF  
Location: 64 Desoto Drive  
Aiken, SC  
Mailing Address: 61 Given Street

Aiken, SC 29805  
County: Aiken  
Previous Orders: None  
Permit/ID Number: ND0014010  
Violations Cited: Pollution Control Act, S.C Code Ann § 48-1- 110 (d) (Supp. 2016); Water Pollution Control Permits, 3 S.C. Code Ann Regs. 61-9.122.41 (d) (2016).

Summary: Aiken County Public School District (Individual/Entity) owns and is responsible for the proper operation and maintenance of a wastewater treatment facility (WWTF) serving Silver Bluff High School, located in Aiken County, South Carolina. On April 17, 2018, a Notice of Violation was issued. The Individual/Entity has violated the Pollution Control Act and Water Pollution Control Permits Regulation as follows: failed to comply with the requirement of the State Land Application Permit to submit to Department an application for renewal of the permit within one hundred eighty (180) days of the expiration of the permit.

Action: The Individual/Entity is required to: submit an administratively complete application for renewal of the State Land Application Permit; continue to operate under the current permit until it is reissued; and, pay a civil penalty in the amount of one thousand dollars **(\$1,000.00)**.

106) Order Type and Number: Consent Order 18-022-W  
Order Date: July 9, 2018  
Individual/Entity: **McCormick Commission of Public Works**  
Facility: McCormick CPW/Rocky Creek WWTF  
Location: 212 Airport Road  
McCormick County, SC  
Mailing Address: 912 South Main Street  
McCormick, SC 29835  
County: McCormick  
Previous Orders: None  
Permit/ID Number: SC0030783  
Violations Cited: Pollution Control Act, S.C Code Ann § 48-1- 110 (d) (Supp. 2016); Water Pollution Control Permits, 3 S.C. Code Ann Regs. 61-9.122.41 (a) and (d) (2016).

Summary: McCormick Commission of Public Works (Individual/Entity) owns and is responsible for the proper operation and maintenance of a wastewater treatment facility (WWTF) located in McCormick County, South Carolina. On July 18, 2016, a Notice of Violation was issued for violations of Whole Effluent Chronic Toxicity (CTOX) reported on discharge monitoring reports submitted to the Department. Individual/Entity has violated the Pollution Control Act and Water Pollution Control Permits Regulation as follows: failed to comply with the effluent discharge limits of its National Pollutant Discharge Elimination System permit for CTQX

Action: The Individual/Entity is required to: submit a corrective action plan to address the deficiencies; initiate a series of accelerated CTOX testing for a period of 1 year following the Order Date; initiate a Toxicity Reduction Evaluation (TRE) and submit related quarterly progress reports if CTOX failure occurs during the 1 year accelerated CTOX testing period; complete TRE within 1 year if initiated; and, pay a civil penalty in the amount of two thousand, eight hundred dollars **(\$2,800.00)**.

107) Order Type and Number: Consent Order 18-023-W  
Order Date: July 16, 2018  
Individual/Entity: **Manchester Farms, Inc.**  
Facility: Manchester Farms, Inc. WWTF  
Location: 5765 Lower Richland Blvd.  
Richland County, SC  
Mailing Address: 8126 Garner's Ferry Road  
Columbia, SC 29209-9402  
County: Richland  
Previous Orders: None  
Permit/ID Number: ND0068969  
Violations Cited: Pollution Control Act, S.C Code Ann § 48-1- 110 (d) (2008 & Supp. 2017); Water Pollution Control Permits, 3 S.C. Code Ann Regs. 61-9.505.41 (a) and (b) (2011).

Summary: Manchester Farms, Inc. (Individual/Entity) owns and is responsible for the proper operation and maintenance of a wastewater treatment facility (WWTF) located in Richland County, South Carolina. On May 24, 2018, a Notice of Violation was issued for failure to submit required annual reports for 2016 and 2017. The Individual/Entity has violated the Pollution Control Act and Water Pollution Control Permits Regulation as follows: failed to comply with the requirement of its State Land Application Permit to submit annual reports

Action: The Individual/Entity is required to: submit annual reports for 2016 and 2017; and, pay a civil penalty in the amount of one thousand dollars **(\$1,000.00)**.

108) Order Type and Number: Consent Order 18-024-W  
Order Date: July 18, 2018  
Individual/Entity: **City of Walterboro**  
Facility: Walterboro WWTP  
Location: End of Secondary Road 393 West of SC Hwy, 303, in the  
City of Walterboro, South Carolina  
Mailing Address: P.O. Box 709  
Walterboro, SC 29488  
County: Colleton  
Previous Orders: 14-051-W (\$4,200.00);  
15-046-W (\$4,500.00)  
Permit/ID Number: SC0040436  
Violations Cited: Pollution Control Act, S.C Code Ann § 48-1- 110 (d) (Supp. 2008 and 2017); Water Pollution Control Permits, 3 S.C. Code Ann Regs. 61-9.122.41 (a) and (d) (2011).

Summary: City of Walterboro (Individual/Entity) owns and is responsible for the proper operation and maintenance of a wastewater treatment plant (WWTP) located in Colleton County, South Carolina. On February 15, 2018, a Notice of Violation was issued for violations of Whole Effluent Chronic Toxicity (CTOX) reported on discharge monitoring reports submitted to the Department. The Individual/Entity has violated the Pollution Control Act and Water Pollution Control Permits Regulation as follows: failed to comply with the effluent discharge limits of its National Pollutant Discharge Elimination System permit for CTOX.

Action: The Individual/Entity is required to: submit a corrective action plan to address the deficiencies; initiate a series of accelerated CTOX testing for a period of 1 year following the Order Date; initiate a Toxicity Reduction Evaluation (TRE) and submit related quarterly progress reports if CTOX failure

occurs during the 1 year accelerated CTOX testing period; complete TRE within 1 year if initiated; and, p a civil penalty in the amount of two thousand, eight hundred dollars **(\$2,800.00)**.

109) Order Type and Number: Consent Order 18-025-W  
Order Date: July 23, 2018  
Individual/Entity: **East Richland County Public Service District**  
Facility: Gills Creek WWTF  
Location: 1050 White House Road  
Columbia, SC 29223  
Mailing Address: 704 Ross Road  
Columbia, SC 29223  
County: Richland  
Previous Orders: None  
Permit/ID Number: SC0038865  
Violations Cited: Pollution Control Act, S.C Code Ann § 48-1- 110 (d) (2008 & Supp. 2017); Water Pollution Control Permits, 3 S.C. Code Ann Regs. 61-9.122.41 (a) and (d) (2011).

Summary: East Richland County Public Service District (Individual/Entity) owns and is responsible for the proper operation and maintenance of a wastewater treatment facility (WWTF) located in Richland County, South Carolina. On January 18, 2018, a Notice of Violation was issued for violations of Whole Effluent Chronic Toxicity (CTOX) reported on discharge monitoring reports submitted to the Department. The Individual/Entity has violated the Pollution Control Act and Water Pollution Control Permits Regulation as follows: failed to comply with the effluent discharge limits of its National Pollutant Discharge Elimination System permit for CTOX

Action: The Individual/Entity is required to: submit a corrective action plan to address the deficiencies; initiate a series of accelerated CTOX testing for a period of 1 year following the Order Date; initiate a Toxicity Reduction Evaluation (TRE) and submit related quarterly progress reports if CTOX failure occurs during the 1 year accelerated CTOX testing period; complete TRE within 1 year if initiated; and, p a civil penalty in the amount of three thousand, four hundred dollars **(\$3,400.00)**.

110) Order Type and Number: Consent Order 18-026-W  
Order Date: July 25, 2018  
Individual/Entity: **Carolina Water Service, Inc.**  
Facility: Briarcreek SD WWTF # 2  
Location: 521 Killian Drive  
Gaffney, SC 29340  
Mailing Address: 150 Foster Brothers Drive  
West Columbia, SC 29172  
County: Cherokee  
Previous Orders: None  
Permit/ID Number: SC0026409  
Violations Cited: Pollution Control Act, S.C Code Ann § 48-1- 110 (d) (2008 & Supp. 2017); Water Pollution Control Permits, 3 S.C. Code Ann Regs. 61-9.122.41 (d) (2011).

Summary: Carolina Water Service, Inc. (Individual/Entity) owns and is responsible for the proper operation and maintenance of a wastewater treatment facility located in Cherokee County, South Carolina. On May 17, 2016, a Notice of Violation was issued for violations of Whole Effluent Chronic Toxicity (CTOX) reported on discharge monitoring reports submitted to the Department. The Individual/Entity has violated

the Pollution Control Act and Water Pollution Control Permits Regulation as follows: failed to comply with the effluent discharge limits of its National Pollutant Discharge Elimination System permit for CTOX.

Action: The Individual/Entity is required to: submit a corrective action plan to address the deficiencies; initiate a series of accelerated CTOX testing for a period of 1 year following the Order Date; initiate a Toxicity Reduction Evaluation (TRE) and submit related quarterly progress reports if CTOX failure occurs during the 1 year accelerated CTOX testing period; complete TRE within 1 year if initiated; and, pay a civil penalty in the amount of three thousand, four hundred dollars **(\$3,400.00)**.

111) Order Type and Number: Consent Order 18-027-W  
Order Date: July 25, 2018  
Individual/Entity: **Franklin W. Howey, Jr.**  
Facility: Frank Howey Family Farms  
Location: Several parcels of farmland in Chesterfield County, SC  
Mailing Address: 912 Fletcher Broome Road  
Monroe, NC 28110  
County: Chesterfield  
Previous Orders: None  
Permit/ID Number: N/A  
Violations Cited: Pollution Control Act, S.C Code Ann § 48-1- 90 (A) (2016); South Carolina Standards for the Permitting of Agricultural Animal Facilities, 3 S.C. Code Ann. Regs. 61-43 Part 400.60.B. 2, C.20, C.7, D.1, 2, and 3(2016)

Summary: Franklin W. Howey, Jr. (Individual/Entity) owns properties, located in Chesterfield County, South Carolina, on which animal manure was stockpiled and land applied. On September 26, 2017 and November 17, 2017, the Department conducted inspections. The Individual/Entity has violated the Pollution Control Act and South Carolina Standards for the Permitting of Agricultural Animal Facilities Regulation as follows: manure was improperly stockpiled, and land applied.

Action: The Individual/Entity is required to: submit notification to the Department that any animal manure stockpiled has been properly covered and/or land applied in accordance with the South Carolina Standards for the Permitting of Agricultural Animal Facilities Regulation; and, pay a civil penalty in the amount of three thousand, seven hundred fifty dollars **(\$3,750.00)**.

112) Order Type and Number: Consent Order 18-028-W  
Order Date: July 25, 2018  
Individual/Entity: **Lenora's Santee Resort, LLC**  
Facility: Lenora's Santee Resort WWTF  
Location: Exit 102, off Interstate 95  
Clarendon County, SC  
Mailing Address: 1531 Tolly Ganly Circle  
Orangeburg, SC 29118  
County: Clarendon  
Previous Orders: None  
Permit/ID Number: ND0067652  
Violations Cited: Pollution Control Act, S.C Code Ann § 48-1- 110 (d) (2008 & Supp. 2017); Water Pollution Control Permits, 3 S.C. Code Ann Regs. 61-9.505.41 (a) and (e) (1) and (2) (2011).

Summary: Lenora's Santee Resort, LLC (Individual/Entity) owns and is responsible for the proper operation and maintenance of a wastewater treatment facility (WWTF) located in Clarendon County, South Carolina. On April 16, 2018, Department staff issued notice to the Individual/Entity of unsatisfactory conditions for violations discovered during an inspection of the WWTF. The Individual/Entity has violated the Pollution Control Act and Water Pollution Control Permits Regulation as follows: failed to properly operate and maintain the WWTF.

Action: The Individual/Entity is required to: submit a corrective action plan to address the deficiencies; submit quarterly reports on progress toward compliance; and, pay a civil penalty in the amount of two thousand dollars **(\$2,000.00)**.

113) Order Type and Number: Consent Order 18-029-W  
Order Date: July 25, 2018  
Individual/Entity: **Carlisle Finishing, LLC**  
Facility: Carlisle Finishing WWTF  
Location: Highway 72 and Highway 121  
Carlisle, South Carolina  
Mailing Address: 3863 Carlisle / Chester Highway  
Carlisle, SC 29031  
County: Union  
Previous Orders: None  
Permit/ID Number: SC0001368  
Violations Cited: Pollution Control Act, S.C Code Ann § 48-1- 110 (d) (Supp. 2008 and 2017); Water Pollution Control Permits, 3 S.C. Code Ann Regs. 61-9.122.41 (a) and (d) (2011).

Summary: Carlisle Finishing, LLC (Individual/Entity) owns and is responsible for the proper operation and maintenance of a wastewater treatment facility (WWTF) located in Union County, South Carolina. On March 2, 2018, a Notice of Violation was issued for violation of *Escherichia coli* reported on discharge monitoring reports submitted to the Department. The Individual/Entity has violated the Pollution Control Act and Water Pollution Control Permits Regulation as follows: failed to comply with the effluent discharge limits of its National Pollutant Discharge Elimination System permit for E. coli

Action: The Individual/Entity is required to: submit a corrective action plan to address the deficiencies; and, pay a civil penalty in the amount of five thousand, six hundred dollars **(\$5,600.00)**.

114) Order Type and Number: Consent Order 18-030-W  
Order Date: August 2, 2018  
Individual/Entity: **Easley Combined Utilities**  
Facility: Golden Creek Lagoon  
Location: State Road S-39-106  
Pickens County, SC  
Mailing Address: P.O. Box 619  
Easley, SC 29641  
County: Pickens  
Previous Orders: None in last 5 years  
Permit/ID Number: SC0023035  
Violations Cited: S.C. Code Ann. § 48-1-110(d) (Supp. 2016); and 24 S.C. Code Ann. Regs. 61-9.122.41(a) (2016)

Summary: Easley Combined Utilities (Individual/Entity) owns and is responsible for the proper operation and maintenance of a wastewater treatment facility (WWTF) located in Pickens County, South Carolina. On September 28, 2017, a Notice of Violation was issued as a result of discharge monitoring reports submitted to the Department. The Individual/Entity has violated the Pollution Control Act and Water Pollution Control Permits Regulation as follows: failed to comply with the effluent discharge limits of its National Pollutant Discharge Elimination System Permit SC0023035 for biological oxygen demand (BOD)

Action: The Individual/Entity is required to: submit a corrective action plan to address the deficiencies; and, pay a civil penalty in the amount of three thousand, four hundred dollars (**\$3,400.00**)

115) Order Type and Number: Consent Order 18-031-W  
Order Date: August 2, 2018  
Individual/Entity: **Williamsburg Recycling, LLC**  
Facility: Bio-Composting Facility  
Location: On Parker Road off Hwy. S-45-45 near intersection of Hwy. 21 and Hwy. 41 in Williamsburg County, SC  
Mailing Address: P.O. Box 262  
Huger, SC 29450  
County: Williamsburg  
Previous Orders: None  
Permit/ID Number: ND0086185  
Violations Cited: S.C. Code Ann. § 48-1-110(d) and § 48-1-50(5) (2008 and Supp. 2016) and 3 S.C. Code Ann. Regs. 61-9.41(a) (2011)

Summary: Williamsburg Recycling, LLC (Individual/Entity) owns and is responsible for the proper operation and maintenance of its Bio-Composting Facility (Site) located in Williamsburg County, South Carolina. On February 3, 2016, and October 24, 2016, Notices of Unsatisfactory Inspections were issued as a result of the Department observing deficiencies during inspection of the Site. The Individual/Entity has violated the Pollution Control Act and Water Pollution Control Permits Regulation as follows: failed to properly operate and maintain the Site; and, conduct proper monitoring and reporting as required by its No Discharge permit.

Action: The Individual/Entity is required to: limit the acceptance of sludge into the Site until completion of its Department approved corrective action plan; confirm that all improperly stored material at the Site has been processed or properly disposed; submit a Site Assessment Plan (SAP) for the soil, groundwater and surface water at the Site; conduct the Department approved SAP; submit a corrective action plan to address the deficiencies; and, pay a **stipulated penalty** in the amount of sixteen thousand seven hundred twenty-five dollars (**\$16,725.00**) should any requirement of the Order not be met.

116) Order Type and Number: Consent Order 18-032-W  
Order Date: August 14, 2018  
Individual/Entity: **Lancaster County School District**  
Facility: Buford High School WWTF  
Location: 300 South Catawba Street  
Lancaster, SC 29720  
Mailing Address: 300 South Catawba Street  
Lancaster, SC 29720  
County: Lancaster  
Previous Orders: None  
Permit/ID Number: SC0030210

Violations Cited: Pollution Control Act, S.C Code Ann § 48-1- 110 (d) (Supp. 2016); Water Pollution Control Permits, 3 S.C. Code Ann Regs. 61-9.122.41 (a) (2016).

Summary: Lancaster County School District (Individual/Entity) owns and is responsible for the proper operation and maintenance of a wastewater treatment facility (WWTF) located in Lancaster County, South Carolina. On June 21, 2018, a Notice of Violation was issued for failing to submit to the Department the results of a water effects ratio (WER) study. The Individual/Entity has violated the Pollution Control Act and Water Pollution Control Permit Regulations as follows: failed to submit results of a WER study as required by its permit.

Action: The Individual/Entity is required to: submit results of a WER study; and, pay a civil penalty in the amount of one thousand, four hundred dollars **(\$1,400.00)**.

117) Order Type and Number: Consent Order 18-034-W  
Order Date: August 17, 2018  
Individual/Entity: **Barbara Scott**  
Facility: Barbara Scott Community Center  
Location: 1762 Cainhoy Road  
Huger, SC  
Mailing Address: 2545 Highway 17 North  
Mt. Pleasant, SC 29466  
County: Berkeley  
Previous Orders: N/A  
Permit/ID Number: SCR10BP86  
Violations Cited: Pollution Control Act, S.C Code Ann § 48-1- 110 (a) (1) (Supp. 2016) and § 48-1- 90 (a) (1) (Supp. 2016).

Summary: Barbara Scott (Individual/Entity) owns and is responsible for the proper operation and maintenance of Scott Community Center located in Berkeley County, South Carolina. On December 13, 2017, a Notice of Violation was issued for storm water violations. The Individual/Entity has violated the Pollution Control Act and Water Pollution Control Permit Regulations as follows: initiated construction beyond the limits of disturbance and failed to properly operate and maintain all components associated with a storm water management system in compliance with permit coverage.

Action: The Individual/Entity is required to: submit a report prepared by a S.C. registered professional engineer; or, a Notice of Termination (NOT); pay a civil penalty in the amount of one thousand one hundred forty eight dollars **(\$1,148.00)**; and pay a suspended penalty in the amount of three thousand, four hundred forty four dollars (\$3,444.00) should any requirement of the Order not be met.

### **Dams Enforcement**

118) Order Type and Number: Consent Order 18-021-W  
Order Date: June 29, 2018  
Individual/Entity: **Oak Hill Golf Partners, LLC**  
Facility: Oak Hills Golf Club Dam  
Location: Off of Hwy. 321, approximately 3 miles north of Exit 70 of I-20  
Mailing Address: Oak Hills Golf Partners, LLC  
7629 Fairfield Road  
Columbia, SC 29203



County: Richland  
Previous Orders: None  
Permit/ID Number: D 0543  
Law Citations: SC Dams and Reservoirs Safety Act, S.C. Code Ann. § 49-11-110, et seq(2008) and Dams and Reservoirs Safety Act Regulations 1254 (2012)

Summary: Oak Hill Golf Partners, LLC (Individual/ Entity) owns and is responsible for the proper operation and maintenance of the Oak Hill Golf Club Dam in Richland County, South Carolina. On October 17, 2017, the Department issued a Notice to Comply to the Individual/Entity for deficiencies regarding the dam. The Individual/Entity has failed to comply with the SC Dams and Reservoirs Safety Act in that the dam or reservoir has not been maintained in a safe condition throughout the life of the structure. The Order is entered into by the Department and the Individual/Entity with respect to remedial actions addressing deficiencies in the condition of the dam.

Action: The Individual/Entity is required to: maintain a lowered water level in the reservoir until Certification of Completion is issued by the Department; submit documentation that a qualified registered professional engineer licensed to practice in South Carolina has been retained; have large trees evaluated by a qualified registered professional engineer licensed to practice in South Carolina to determine if they should be removed; submit a permit application and tree management plan prepared by a qualified registered professional engineer licensed to practice in South Carolina for the repair or removal of the dam; submit documentation that all local, state, and federal permit applications have been submitted; complete all construction activities in accordance with approved plans for the repair or removal of the dam.

### **BUREAU OF AIR QUALITY**

119) Order Type and Number: Consent Order 18-028-A  
Order Date: June 1, 2018  
Individual/Entity: **SCPSA d.b.a. Santee Cooper**  
Facility: Santee Cooper – Winyah Facility & Santee Cooper – Cross Facility  
Location: 661 Steam Plant Drive  
Georgetown, SC 29440  
553 Cross Station Road  
Pineville, SC 29468  
Mailing Address: P.O. Box 2946101  
Moncks Corner, SC 29461  
County: Georgetown/Berkeley  
Previous Orders: N/A  
Permit/ID Number: Winyah: 1140-0005  
Cross: 0420-0030  
Violations Cited: U.S. EPA 40 CFR 63 and 5 S.C. Code Ann. Regs. 61-62.63, National Emission Standards for Hazardous Air Pollutants for Source Categories, Subpart UUUUU, National Emission Standards for Hazardous Air Pollutants: Coal- and Oil-Fired Electric Utility Steam Generating Units.

Summary: SCPSA d.b.a. Santee Cooper (Individual/Entity), operates electric and water utilities facilities located in Georgetown and Pineville, South Carolina. A review of the Individual/Entity's semiannual reports for each facility indicated multiple periods of monitor downtime of its continuous monitoring system for mercury. The Individual/Entity violated U.S. EPA regulations at CFR 40 and South Carolina Air Pollution

Control Regulations as follows: failed to ensure that its continuous monitoring systems were kept in continuous operations.

Action: The Individual/Entity is required to: comply with Subpart UUUUU and pay to the Department a civil penalty in the amount of eight thousand, five hundred dollars **(\$8,500.00)**.

120) Order Type and Number: Consent Order 18-029-A  
Order Date: June 14, 2018  
Individual/Entity: **Prestige Composite, LLC**  
Facility: N/A  
Location: 1622 Two Notch Road  
Lexington SC 29073  
Mailing Address: Same  
County: Lexington  
Previous Orders: None  
Permit/ID Number: 1560-0209  
Violations Cited: 5 S.C. Code Ann. Regs. 61-62.1 (Supp. 2017); U.S. EPA 40 CFR Part 70, State Operating Permit Programs and 5 S.C. Code Ann. Regs. 61-62.70, Title V Operating Permit Program; and, U.S. EPA 40 CFR Part 63 and 5 S.C. Code Ann. Regs. 61-62.63, National Emission Standards For Hazardous Air Pollutants For Source Categories, Subpart WWWW National Emission Standards for Hazardous Air Pollutants: Reinforced Plastic Composites Products

Summary: Prestige Composite, LLC (Individual/Entity), located in Lexington, South Carolina manufactures reinforced composite parts. The Department conducted an inspection on May 4, 2017. The Individual/Entity has violated the U.S. EPA regulations at CFR 40 and South Carolina Air Pollution Control Regulations as follows: failed to submit to the Department a construction permit application prior to constructing and operating a source of air contaminants; failed to submit a Title V permit application to the Department within 12 months after becoming subject to the Title V Permit Regulations; failed to demonstrate compliance with Subpart WWWW upon start-up; and, failed to submit all applicable notifications and semi-annual compliance reports as required by Subpart WWWW.

Action: The Individual/Entity is required to: comply with any Department-issued construction and/or operating permits; submit to the Department a construction permit application prior to constructing and operating a source of air contaminants; maintain compliance with all requirements of Subpart WWWW including but not limited to, record keeping, reporting, emissions limitations, and work practice standards and, pay a civil penalty in the amount of twelve thousand dollars **(\$12,000.00)**.

121) Order Type and Number: Consent Order 18-030-A  
Order Date: July 06, 2018  
Individual/Entity: **Mr. Donald English and Ms. Sylvia Guyton English**  
Facility: Residential Property  
Location: 2139 Elm Village Drive  
Summerville, SC 29483  
Mailing Address: 102 Berkeley Square Lane, Suite E  
Goose Creek, SC 29445  
County: Berkeley  
Previous Orders: AO 18-009-A (\$10,500.00)  
Permit/ID Number: N/A  
Violations Cited: 5 S.C. Code Ann. Regs. 61-62.2, Prohibition of Open Burning

Summary: Ms. Sylvia Guyton English is the owner of the property located at 2139 Elm Village Drive in Summerville, South Carolina, (Site) and Mr. Donald English resides at the Site (Individual/Entity). The Department conducted open burning investigations in response to complaints on January 31, 2018, February 05, 2018, February 23, 2018, March 09, 2018, April 04, 2018, and April 10, 2018. The Individual/Entity has violated the South Carolina Air Pollution Control Regulations as follows: burn materials other than those specifically allowed by Section I of the Regulation.

Action: The Individual/Entity is required to: cease all open burning at the Site; pay a civil penalty in the amount of five hundred dollars (**\$500.00**); and pay a suspended penalty in the amount of twelve thousand two hundred fifty dollars (\$12,250.00) should any requirement of the Order not be met.

122) Order Type and Number: Consent Order 18-031-A  
Order Date: July 27, 2018  
Individual/Entity: **Ameresco Federal Solutions, Inc.**  
Facility: Savannah River Site  
Location: Savannah River Site  
Mailing Address: 520 W Summit Hill Drive, Suite 401  
Knoxville, TN 37902  
County: Aiken  
Previous Orders: None  
Permit/ID Number: 0080-0144  
Violations Cited: U.S. Environmental Protection Agency (“EPA”) regulations at 40 CFR Part 52, Prevention of Significant Deterioration, and 5 S.C. Code Ann. Regs. 61-62.5 (Supp. 2017), Standard 7, Prevention of Significant Deterioration, (collectively “PSD Regulations”) U.S. EPA regulations at 40 CFR Part 63 and 5 SC Code Ann. Regs. 61-62.63 (Supp. 2017), National Emission Standards for Hazardous Air Pollutants For Affected Source Categories, Subpart DDDDD – National Emission Standards For Hazardous Air Pollutants for Major Sources: Industrial, Commercial, and Institutional Boilers and Process Heaters, (collectively “Subpart 5D”); and 5 S.C. Code Ann. Regs. 61-62.1, Section II, Permit Requirements

Summary: Ameresco Federal Solutions, Inc., (Individual/Entity), located in Aiken, South Carolina, produces electricity to support operations at the Savannah River Site. The Department conducted a review of records submitted by the Individual/Entity on August 1, 2017, and March 7, 2018. The Individual/Entity has violated U.S. EPA regulations at 40 CFR and South Carolina Air Pollution Control Regulations as follows: failed to limit CO emissions from boiler BCB-3 to 620 ppm during a Department-approved source test on January 15, 2018; and failed to demonstrate continuous compliance with Subpart 5D operating limits, by maintaining the 30 day rolling average oxygen content for boiler BCB-3 above 6.41%, for 18 days in February and March of 2017.

Action: The Individual/Entity is required to: maintain continuous compliance with all applicable PSD Regulations and Best Available Control Technology requirements; limit CO emissions from BCB-3 to 620 ppm @ 3% oxygen; demonstrate continuous compliance with Subpart 5D operating limits, by maintaining the 30 day rolling average oxygen content for boiler BCB-3 at or above 6.54%, until and unless the minimum oxygen content is reestablished through a Department-approved source test; pay a civil penalty in the amount of twenty-four thousand dollars (**\$24,000.00**).

123) Order Type and Number: Consent Order 18-033-A  
Order Date: August 14, 2018  
Individual/Entity: **Nan Ya Plastics Corporation, America**  
Facility: Nan Ya Plastics Corporation, America  
Location: 140 East Beulah Road

Mailing Address: Lake City, SC 29560  
County: Same  
Previous Orders: Williamsburg  
Permit/ID Number: None  
Violations Cited: 2320-0034  
Requirements: 5 S.C. Code Ann. Regs. 61-62.1 Section II Permit and, U.S. EPA 40 CFR 63 and 5 S.C. Code Ann. Regs. 61-62.63, Subpart JJJ

Summary: Nan Ya Plastics Corporation, America (Individual/Entity), located in Lake City, South Carolina, manufactures products using a continuous polymerization process. During a review of semiannual reports submitted by the Individual/Entity on October 27, 2016, April 17, 2017, and October 30, 2017, the Department discovered multiple periods during which the thermal oxidizers used to control emissions from the wastewater treatment process, were not in operation. On April 3, 2018, the Department issued a Notice of Alleged Violation and Notice of Enforcement Conference to the Individual/Entity. Following the enforcement conference, the Department reviewed the Title V Annual Compliance Certification's (TVACC) submitted by the Individual/Entity to the EPA and the Department from 2014 to 2018 and determined that the TVACCs were inaccurate. The Individual/Entity has violated US EPA regulations at 40 CFR and the South Carolina Air Pollution Control Regulations as follows: failed to control emissions from the wastewater treatment process as required by applicable regulations; and, failed to submit accurate TVACCs to the EPA and Department for reporting periods during which emissions were not controlled as required.

Action: The Individual/Entity is required to: henceforth, ensure that it achieves and maintains compliance with all applicable requirements.; henceforth, submit to the EPA and the Department complete and accurate TVACCs for each reporting period; submit to the EPA and the Department revised TVACCs for reporting periods during which emissions were not controlled as required; submit to the Department a report detailing a plan for continuous compliance; submit a complete and accurate Notification of Compliance Status to the Department addressing all compliance options and requirements; and, pay a civil penalty in the amount of fourteen thousand dollars (**\$14,000.00**).

124) Order Type and Number: Consent Order 18-034-A  
Order Date: August 14, 2018  
Individual/Entity: **Perdue Foods LLC**  
Facility: Perdue Foods LLC  
Location: 2047 Highway 9 West  
 Dillon, SC 29536  
Mailing Address: P.O. Box 2159  
 Dillon, SC 29536  
County: Dillon  
Previous Orders: None  
Permit/ID Number: 0880-0029  
Violations Cited: U.S. EPA 40 CFR 68 and 5 S.C. Code Ann. Regs. 61-62.68, Chemical Accident Prevention Provisions Regulations)

Summary: Perdue Foods LLC (Individual/Entity), located in Dillon, South Carolina, operates a poultry slaughterhouse, and uses anhydrous ammonia as a refrigerant. On March 6, 2018, the Department conducted an investigation at the Individual/Entity following the release of anhydrous ammonia. On May 8, 2018, the Department issued a Notice of Alleged Violation and Notice of Enforcement Conference to the Individual/Entity. The Individual/Entity violated US EPA regulations at 40 CFR and South Carolina Air Pollution Control Regulations as follows: failed to promptly address process hazard analysis (PHA) findings and recommendations and provide refresher training at least every three years to employees.

Action: The Individual/Entity is required to: provide refresher training every three years on covered processes; correct identified deficiencies; and pay to the Department a civil penalty in the amount of eight thousand, five hundred dollars (**\$8,500.00**).

125) Order Type and Number: Consent Order 18-035-A  
Order Date: August 16, 2018  
Individual/Entity: **Ms. Joyce Wooten**  
Facility: Residential Property  
Location: 127 Elizabeth Street  
Warrenville, SC 29851  
Mailing Address: Same  
County: Aiken  
Previous Orders: None  
Permit/ID Number: N/A  
Violations Cited: 5 S.C. Code Ann. Regs. 61-62.2 Prohibition of Open Burning

Summary: Ms. Joyce Wooten (Individual/Entity) owns property and resides at 127 Elizabeth Street in Warrenville, South Carolina (Site). The Department conducted an investigation in response to a complaint of open burning at the Site on February 26, 2018. On March 27, 2018, the Department issued a Notice of Alleged Violation and Notice of Enforcement Conference to the Individual/Entity. The Individual/Entity has violated the South Carolina Air Pollution Control Regulations as follows: burned materials other than those specifically allowed by the Regulation, specifically: treated wood and plastic.

Action: The Individual/Entity is required to: Immediately and henceforth cease all open burning except as in compliance with 5 S.C. Code Ann. Regs. 61-62.2, Prohibition of Open Burning; pay to the Department a civil penalty in the amount of one hundred fifty dollars (**\$150.00**), and pay a stipulated penalty in the amount of one thousand three hundred fifty dollars (\$1,350.00) should any requirement of the Order not be met.

126) Order Type and Number: Consent Order 18-036-A  
Order Date: August 17, 2018  
Individual/Entity: **Kelley Contracting Services, LLC**  
Facility: Former Summit Place Apts.  
Location: 400 Summit Drive  
Greenville, SC 29609  
Mailing Address: 121 Motor Boat Club Road  
Greenville, SC 29611  
County: Greenville  
Previous Orders: None  
Permit/ID Number: N/A  
Violations Cited: U.S. EPA 40 CFR Part 61, NESHAP Subpart M, National Emission Standards for Asbestos, S.C. Code Ann. Regs. 61-86 Standards of Performance for Asbestos Projects

Summary: Kelley Contract Services, LLC (Individual/Entity), specializes in residential remodeling. On June 8, 2016, the Department conducted an asbestos inspection of an unpermitted renovation operation at 400 Summit Drive in Greenville, SC performed by the Individual/Entity. The Individual/Entity violated US EPA regulations at 40 CFR and South Carolina Standards of Performance for Asbestos Projects as follows: failed to perform an asbestos building inspection, failed to submit written notices of intent to renovate, failed to ensure asbestos-containing material

(ACM) was removed in accordance with the regulation, failed to obtain asbestos project licenses, failed to ensure that workers and supervisors met training and licensing requirements, and failed to ensure that ACM was properly disposed of.

Action: The Individual/Entity is required to: ensure that asbestos building inspections are performed for any future renovation or demolition operations, and that licenses are obtained prior to engaging in asbestos projects; pay to the Department a civil penalty in the amount of two thousand, eight hundred dollars (**\$2,800.00**); and pay a stipulated penalty in the amount of twenty-five thousand two hundred dollars (\$25,200.00) should any requirement of the order not be met.

## **BUREAU OF ENVIRONMENTAL HEALTH SERVICES**

### **Food Safety Enforcement**

127) Order Type and Number: Administrative Order 2017-206-01-027  
Order Date: June 8, 2018  
Individual/Entity: **Scholtzsky's Deli**  
Facility: Scholtzsky's Deli  
Location: 603 East Greenville Street  
Anderson, SC 29621  
Mailing Address: Same  
County: Anderson  
Previous Orders: None  
Permit Number: 04-206-04255  
Violations Cited: S.C. Code Ann. Regs. 61-25

Summary: Scholtzsky's Deli (Individual/Entity) located in Anderson, South Carolina, is a restaurant. The Department conducted inspections on May 11, 2017, October 12, 2017, and October 16, 2017. The Individual/Entity has violated the South Carolina Retail Food Establishment Regulation as follows: failed to maintain proper holding temperatures of time/temperature control for safety foods.

Action: The Individual/Entity is required to: operate and maintain the facility in accordance with the requirements of all applicable regulations, including S.C. Regs. 61-25 and pay a civil penalty in the amount of one thousand dollars (**\$1,000.00**).

128) Order Type and Number: Administrative Order 2018-206-01-008  
Order Date: June 8, 2018  
Individual/Entity: **Marie McClain, Individually and d.b.a. Antreville Auction House**  
Facility: Marie McClain, Individually and d.b.a. Antreville Auction House  
Location: 391 Captains Road  
Donalds, SC 29638  
Mailing Address: 5923 Highway 28  
Iva, SC 29655  
County: Anderson  
Previous Orders: None

Permit Number: None  
Violations Cited: S.C. Code Ann. Regs. 61-25

Summary: Marie McClain, Individually and d.b.a. Antreville Auction House (Individual/Entity) conducts food service activities in Anderson, South Carolina. The Department conducted complaint investigations on December 20, 2017, and January 24, 2018. The Individual/Entity has violated the South Carolina Retail Food Establishment Regulation as follows: operated a retail food service establishment without a permit from the Department.

Action: The Individual/Entity is required to: cease all food service operations until a Retail Food Establishment Permit is obtained through the Department and pay a civil penalty in the amount of two thousand dollars **(\$2,000.00)**.

129) Order Type and Number: Administrative Order 2018-206-02-017  
Order Date: August 20, 2018  
Individual/Entity: **Green Lettuce**  
Facility: Green Lettuce  
Location: 19 Augusta Street  
Greenville, SC 29601  
Mailing Address: Same  
County: Greenville  
Previous Orders: 2017-206-02-015 (\$800.00)  
Permit Number: 23-206-10621  
Violations Cited: S.C. Code Ann. Regs. 61-25

Summary: Green Lettuce (Individual/Entity), located in Greenville, South Carolina, is a restaurant. The Department conducted inspections on August 30, 2016, May 17, 2017, and March 1, 2018. The Individual/Entity has violated the South Carolina Retail Food Establishment Regulation as follows: failed to maintain proper holding temperatures of time/temperature control for safety foods (P) and failed to ensure that when time without temperature control is used as a public health control, the food in unmarked containers or packages shall be discarded (P).

Action: The Individual/Entity is required to: operate and maintain the facility in accordance with the requirements of all applicable regulations, including S.C. Regs. 61-25 and pay a civil penalty in the amount of one thousand dollars **(\$1,000.00)**.

130) Order Type and Number: Consent Order 2018-206-01-017  
Order Date: June 1, 2018  
Individual/Entity: **Fruit Punch**  
Facility: Fruit Punch  
Location: 4431 Highway 24  
Anderson, SC 29626  
Mailing Address: Same  
County: Anderson  
Previous Orders: 2017-206-01-011 (\$550.00)  
Permit Number: 04-206-02230  
Violations Cited: S.C. Code Ann. Regs. 61-25

Summary: Fruit Punch (Individual/Entity), located in Anderson, South Carolina, is a restaurant. The Department conducted an inspection on May 1, 2018. The Individual/Entity has violated the South

Carolina Retail Food Establishment Regulation as follows: failed to maintain proper holding temperatures of time/temperature control for safety foods.

Action: The Individual/Entity is required to: operate and maintain the facility in accordance with the requirements of all applicable regulations, including S.C. Regs. 61-25 and pay a civil penalty in the amount of one thousand dollars **(\$1,000.00)**.

131) Order Type and Number: Consent Order 2018-206-02-015  
Order Date: June 1, 2018  
Individual/Entity: **Ink "N" Ivy**  
Facility: Ink "N" Ivy  
Location: 21 East Coffee Street  
Greenville, SC 29601  
Mailing Address: Same  
County: Greenville  
Previous Orders: None  
Permit Number: 23-206-11423  
Violations Cited: S.C. Code Ann. Regs. 61-25

Summary: Ink "N" Ivy (Individual/Entity), located in Greenville, South Carolina, is a restaurant. The Department conducted inspections on August 18, 2016, August 26, 2016, May 15, 2017, May 19, 2017, and February 22, 2018. The Individual/Entity has violated the South Carolina Retail Food Establishment Regulation as follows: failed to use effective methods to cool cooked time/temperature control for safety foods and failed to ensure that when time without temperature control is used as a public health control, the food in unmarked containers or packages shall be discarded.

Action: The Individual/Entity is required to: operate and maintain the facility in accordance with the requirements of all applicable regulations, including S.C. Regs. 61-25 and pay a civil penalty in the amount of one thousand, six hundred dollars **(\$1,600.00)**.

132) Order Type and Number: Consent Order 2018-206-03-032  
Order Date: June 1, 2018  
Individual/Entity: **Best China Buffet**  
Facility: Best China Buffet  
Location: 421 Bush River Road, Unit 470  
Columbia, SC 29210  
Mailing Address: Same  
County: Richland  
Previous Orders: None  
Permit Number: 40-206-08068  
Violations Cited: S.C. Code Ann. Regs. 61-25

Summary: Best China Buffet (Individual/Entity), located in Columbia, South Carolina, is a restaurant. The Department conducted inspections on October 16, 2017, December 11, 2017, and March 23, 2018. The Individual/Entity has violated the South Carolina Retail Food Establishment Regulation as follows: failed to clearly mark the date by which food shall be consumed on the premises, sold, or discarded when held at a temperature of 41°F or less for a maximum of seven (7) days; and failed to ensure that when time without temperature control is used as a public health control, the food in unmarked containers or packages shall be discarded.



Action: The Individual/Entity is required to: operate and maintain the facility in accordance with the requirements of all applicable regulations, including S.C. Regs. 61-25 and pay a civil penalty in the amount of eight hundred dollars (**\$800.00**).

133) Order Type and Number: Consent Order 2018-206-06-040  
Order Date: June 1, 2018  
Individual/Entity: **Key West Grill**  
Facility: Key West Grill  
Location: 1214 Celebrity Circle  
Myrtle Beach, SC 29577  
Mailing Address: 2008 Savannah Highway  
Myrtle Beach, SC 29407  
County: Horry  
Previous Orders: 2017-206-06-059 (\$800.00)  
Permit Number: 26-206-07038  
Violations Cited: S.C. Code Ann. Regs. 61-25

Summary: Key West Grill (Individual/Entity), located in Myrtle Beach, South Carolina, is a restaurant. The Department conducted an inspection on April 6, 2018. The Individual/Entity has violated the South Carolina Retail Food Establishment Regulation as follows: failed to maintain proper hot temperatures of time/temperature control for safety foods.

Action: The Individual/Entity is required to: operate and maintain the facility in accordance with the requirements of all applicable regulations, including S.C. Regs. 61-25 and pay a civil penalty in the amount of one thousand dollars (**\$1,000.00**).

134) Order Type and Number: Consent Order 2018-206-03-024  
Order Date: June 11, 2018  
Individual/Entity: **San Jose**  
Facility: San Jose  
Location: 1475 Old Orangeburg Road  
Lexington, SC 29073  
Mailing Address: 1945 Decker Boulevard, Suite 19  
Columbia, SC 29206  
County: Lexington  
Previous Orders: None  
Permit Number: 32-206-05903  
Violations Cited: S.C. Code Ann. Regs. 61-25

Summary: San Jose (Individual/Entity), located in Lexington, South Carolina, is a restaurant. The Department conducted inspections on January 19, 2017, January 17, 2018, January 24, 2018, and February 2, 2018. The Individual/Entity has violated the South Carolina Retail Food Establishment Regulation as follows: failed to properly cool cooked time/temperature control for safety foods and failed to use effective methods to cool cooked time/temperature control for safety foods.

Action: The Individual/Entity is required to: operate and maintain the facility in accordance with the requirements of all applicable regulations, including S.C. Regs. 61-25 and pay a civil penalty in the amount of one thousand, six hundred dollars (**\$1,600.00**).

135) Order Type and Number: Consent Order 2018-206-03-033  
Order Date: June 11, 2018  
Individual/Entity: **Libby's**  
Facility: Libby's  
Location: 116 West Main Street  
Lexington, SC 29072  
Mailing Address: Same  
County: Lexington  
Previous Orders: 2017-206-03-071 (\$1,550.00)  
Permit Number: 32-206-05787  
Violations Cited: S.C. Code Ann. Regs. 61-25

Summary: Libby's (Individual/Entity), located in Lexington, South Carolina, is a restaurant. The Department conducted an inspection on April 4, 2018. The Individual/Entity has violated the South Carolina Retail Food Establishment Regulation as follows: failed to keep food contact surfaces, nonfood contact surfaces, and utensils clean and free of accumulation of dust, dirt, food residue and other debris and failed to clean the physical facilities as often as necessary to keep them clean.

Action: The Individual/Entity is required to: operate and maintain the facility in accordance with the requirements of all applicable regulations, including S.C. Regs. 61-25 and pay a civil penalty in the amount of two hundred fifty dollars (**\$250.00**).

136) Order Type and Number: Consent Order 2018-206-03-037  
Order Date: June 11, 2018  
Individual/Entity: **Hokkaido Buffet**  
Facility: Hokkaido Buffet  
Location: 1100 Dutch Fork Road, Suite K  
Irmo, SC 29063  
Mailing Address: Same  
County: Richland  
Previous Orders: 2017-206-03-005 (\$800.00)  
Permit Number: 40-206-06596  
Violations Cited: S.C. Code Ann. Regs. 61-25

Summary: Hokkaido Buffet (Individual/Entity), located in Irmo, South Carolina, is a restaurant. The Department conducted inspections on September 7, 2016, May 5, 2017, and April 23, 2018. The Individual/Entity has violated the South Carolina Retail Food Establishment Regulation as follows: failed to maintain proper holding temperatures of time/temperature control for safety foods; failed to demonstrate knowledge of foodborne disease prevention by having no priority violations during the inspection; and failed to ensure written procedures were in place and made available to the Department when the facility uses Time as a Public Health Control.

Action: The Individual/Entity is required to: operate and maintain the facility in accordance with the requirements of all applicable regulations, including S.C. Regs. 61-25 and pay a civil penalty in the amount of one thousand, two hundred fifty dollars (**\$1,250.00**).

137) Order Type and Number: Consent Order 2018-206-05-005  
Order Date: June 11, 2018  
Individual/Entity: **Red Bowl Asian Bistro**  
Facility: Red Bowl Asian Bistro  
Location: 2645 Whiskey Road

Mailing Address: Aiken, SC 29803  
County: Same  
Previous Orders: Aiken  
Permit Number: None  
Violations Cited: 02-206-02695  
S.C. Code Ann. Regs. 61-25

Summary: Red Bowl Asian Bistro (Individual/Entity), located in Aiken, South Carolina, is a restaurant. The Department conducted inspections on September 18, 2017, January 30, 2018, and April 12, 2018. The Individual/Entity has violated the South Carolina Retail Food Establishment Regulation as follows: failed to maintain proper holding temperatures of time/temperature control for safety foods and failed to demonstrate knowledge of foodborne disease prevention by having no priority violations during the inspection.

Action: The Individual/Entity is required to: operate and maintain the facility in accordance with the requirements of all applicable regulations, including S.C. Regs. 61-25 and pay a civil penalty in the amount of five hundred fifty dollars **(\$550.00)**.

138) Order Type and Number: Consent Order 2018-206-06-027  
Order Date: June 11, 2018  
Individual/Entity: **Subway #24384**  
Facility: Subway #24384  
Location: 3944 Highway 17  
Murrells Inlet, SC 29576  
Mailing Address: 3691 Palmetto Point Boulevard #101  
Myrtle Beach, SC 29588  
County: Georgetown  
Previous Orders: 2016-206-06-103 (\$800.00)  
Permit Number: 22-206-05702  
Violations Cited: S.C. Code Ann. Regs. 61-25

Summary: Subway #24384 (Individual/Entity), located in Murrells Inlet, South Carolina, is a restaurant. The Department conducted an inspection on February 27, 2018. The Individual/Entity violated the South Carolina Retail Food Establishment Regulation as follows: failed to maintain proper holding temperatures of time/temperature control for safety foods.

Action: The Individual/Entity is required to: operate and maintain the facility in accordance with the requirements of all applicable regulations, including S.C. Regs. 61-25 and pay a civil penalty in the amount of one thousand dollars **(\$1,000.00)**.

139) Order Type and Number: Consent Order 2018-206-06-042  
Order Date: June 11, 2018  
Individual/Entity: **Applebee's #706**  
Facility: Applebee's #706  
Location: 7915 North Kings Highway  
Myrtle Beach, SC 29572  
Mailing Address: 170 Wind Chime Court  
Raleigh, NC 27615  
County: Horry  
Previous Orders: 2016-206-06-051 (\$1,200.00)  
Permit Number: 26-206-11806

Violations Cited:

S.C. Code Ann. Regs. 61-25

Summary: Applebee's #706 (Individual/Entity), located in Myrtle Beach, South Carolina, is a restaurant. The Department conducted inspections on November 29, 2017, January 25, 2018, and April 11, 2018. The Individual/Entity has violated the South Carolina Retail Food Establishment Regulation as follows: failed to keep food contact surfaces, nonfood contact surfaces, and utensils clean and free of accumulation of dust, dirt, food residue and other debris.

Action: The Individual/Entity is required to: operate and maintain the facility in accordance with the requirements of all applicable regulations, including S.C. Regs. 61-25 and pay a civil penalty in the amount of two hundred dollars **(\$200.00)**.

140) Order Type and Number: Consent Order 2018-206-07-010  
Order Date: June 11, 2018  
Individual/Entity: **Collective Coffee Company**  
Facility: Collective Coffee Company  
Location: 766 South Shelmore Blvd.  
Mount Pleasant, SC 29646  
Mailing Address: 50 Laurens Street  
Charleston, SC 29401  
County: Charleston  
Previous Orders: None  
Permit Number: 10-206-08477  
Violations Cited: S.C. Code Ann. Regs. 61-25

Summary: Collective Coffee Company (Individual/Entity), located in Mount Pleasant, South Carolina, is a restaurant. The Department conducted inspections on April 14, 2017, April 2, 2018, and April 11, 2018. The Individual/Entity has violated the South Carolina Retail Food Establishment Regulation as follows: failed to maintain proper holding temperatures of time/temperature control for safety foods.

Action: The Individual/Entity is required to: operate and maintain the facility in accordance with the requirements of all applicable regulations, including S.C. Regs. 61-25 and pay a civil penalty in the amount of eight hundred dollars **(\$800.00)**.

141) Order Type and Number: Consent Order 2018-206-07-012  
Order Date: June 11, 2018  
Individual/Entity: **JD's Market**  
Facility: JD's Market  
Location: 614 Rutledge Avenue  
Charleston, SC 29403  
Mailing Address: Same  
County: Charleston  
Previous Orders: None  
Permit Number: 10-206-09623  
Violations Cited: S.C. Code Ann. Regs. 61-25

Summary: JD's Market (Individual/Entity), located in Charleston, South Carolina, is a restaurant. The Department conducted inspections on March 30, 2018, April 10, 2018, and April 23, 2018. The Individual/Entity has violated the South Carolina Retail Food Establishment Regulation as follows: failed to maintain proper holding temperatures of time/temperature control for safety foods.

Action: The Individual/Entity is required to: operate and maintain the facility in accordance with the requirements of all applicable regulations, including S.C. Regs. 61-25 and pay a civil penalty in the amount of eight hundred dollars (**\$800.00**).

142) Order Type and Number: Consent Order 2018-206-07-014  
Order Date: June 11, 2018  
Individual/Entity: **Bi-Lo #5743 Deli**  
Facility: Bi-Lo #5743 Deli  
Location: 3575 Maybank Highway  
Johns Island, SC 29455  
Mailing Address: P.O. Box 2209  
Jacksonville, FL 32203  
County: Charleston  
Previous Orders: None  
Permit Number: 10-206-08649  
Violations Cited: S.C. Code Ann. Regs. 61-25

Summary: Bi-Lo #5743 Deli (Individual/Entity), located in Johns Island, South Carolina, is a deli. The Department conducted inspections on September 20, 2017, April 18, 2018, and April 27, 2018. The Individual/Entity has violated the South Carolina Retail Food Establishment Regulation as follows: failed to maintain proper holding temperatures of time/temperature control for safety foods.

Action: The Individual/Entity is required to: operate and maintain the facility in accordance with the requirements of all applicable regulations, including S.C. Regs. 61-25 and pay a civil penalty in the amount of eight hundred dollars (**\$800.00**).

143) Order Type and Number: Consent Order 2018-206-08-008  
Order Date: June 11, 2018  
Individual/Entity: **Crazy Crab Harbour Town**  
Facility: Crazy Crab Harbour Town  
Location: 149 Lighthouse Road  
Hilton Head Island, SC 29928  
Mailing Address: 7B Greenwood Drive, Suite 9  
Hilton Head Island, SC 29928  
County: Beaufort  
Previous Orders: None  
Permit Number: 07-206-00680  
Violations Cited: S.C. Code Ann. Regs. 61-25

Summary: Crazy Crab Harbour Town (Individual/Entity), located in Hilton Head Island, South Carolina, is a restaurant. The Department conducted inspections on November 30, 2016, June 14, 2017, and April 17, 2018. The Individual/Entity has violated the South Carolina Retail Food Establishment Regulation as follows: failed to maintain proper holding temperatures of time/temperature control for safety foods and failed to protect food from contamination by storing in a clean, dry location, where it is not exposed to splash, dust, or other contamination, at least 6 inches above the floor.

Action: The Individual/Entity is required to: operate and maintain the facility in accordance with the requirements of all applicable regulations, including S.C. Regs. 61-25 and pay a civil penalty in the amount of eight hundred dollars (**\$800.00**).

144) Order Type and Number: Consent Order 2018-206-08-009  
Order Date: June 11, 2018  
Individual/Entity: **Subway #11**  
Facility: Subway #11  
Location: 80 Baylor Drive, Suite 101  
Bluffton, SC 29910  
Mailing Address: P.O. Box 24204  
Hilton Head Island, SC 29925  
County: Beaufort  
Previous Orders: None  
Permit Number: 07-206-04700  
Violations Cited: S.C. Code Ann. Regs. 61-25

Summary: Subway #11 (Individual/Entity), located in Bluffton, South Carolina, is a restaurant. The Department conducted inspections on July 17, 2017, July 27, 2017, April 10, 2018, and April 20, 2018. The Individual/Entity has violated the South Carolina Retail Food Establishment Regulation as follows: failed to maintain proper holding temperatures of time/temperature control for safety foods and failed to ensure that a person in charge, is certified by a food protection manager certification program that is recognized by the Conference for Food Protection.

Action: The Individual/Entity is required to: operate and maintain the facility in accordance with the requirements of all applicable regulations, including S.C. Regs. 61-25 and pay a civil penalty in the amount of one thousand, six hundred dollars (**\$1,600.00**).

145) Order Type and Number: Consent Order 2018-206-02-024  
Order Date: June 13, 2018  
Individual/Entity: **Luna Rosa Gelato Café**  
Facility: Luna Rosa Gelato Café  
Location: 9 West Washington Street  
Greenville, SC 29601  
Mailing Address: Same  
County: Greenville  
Previous Orders: None  
Permit Number: 23-206-09388  
Violations Cited: S.C. Code Ann. Regs. 61-25

Summary: Luna Rosa Gelato Café (Individual/Entity), located in Greenville, South Carolina, is a restaurant. The Department conducted inspections on August 24, 2016, May 8, 2017, and March 12, 2018. The Individual/Entity has violated the South Carolina Retail Food Establishment Regulation as follows: failed to ensure that when time without temperature control is used as a public health control, the food in unmarked containers or packages shall be discarded.

Action: The Individual/Entity is required to: operate and maintain the facility in accordance with the requirements of all applicable regulations, including S.C. Regs. 61-25 and pay a civil penalty in the amount of eight hundred dollars (**\$800.00**).

146) Order Type and Number: Consent Order 2018-206-07-003  
Order Date: June 13, 2018  
Individual/Entity: **Great Wall**  
Facility: Great Wall  
Location: 1909 North Highway 17, Suite J

Mailing Address: Mount Pleasant, SC 29464  
County: Same  
Previous Orders: Charleston  
Permit Number: None  
Violations Cited: 10-206-02276  
S.C. Code Ann. Regs. 61-25

Summary: Great Wall (Individual/Entity), located in Mount Pleasant, South Carolina, is a restaurant. The Department conducted inspections on July 13, 2017, April 3, 2018, and April 10, 2018. The Individual/Entity has violated the South Carolina Retail Food Establishment Regulation as follows: failed to provide a test kit or other device that accurately measures the concentration of MG/L of sanitizing solution and failed to clearly mark the date by which food shall be consumed on the premises, sold, or discarded when held at a temperature of 41°F or less for a maximum of seven (7) days. This applies only to refrigerated, ready-to-eat, time/temperature control for safety foods prepared and held in a food establishment for more than twenty-four (24) hours and failed to ensure that when time without temperature control is used as a public health control, the food in unmarked containers or packages shall be discarded.

Action: The Individual/Entity is required to: operate and maintain the facility in accordance with the requirements of all applicable regulations, including S.C. Regs. 61-25 and pay a civil penalty in the amount of four hundred dollars **(\$400.00)**.

147) Order Type and Number: Consent Order 2018-206-06-046  
Order Date: June 18, 2018  
Individual/Entity: **Chipotle Mexican Grill**  
Facility: Chipotle Mexican Grill  
Location: 1000 South Commons Drive, Suite 101  
Myrtle Beach, SC 29588  
Mailing Address: 1401 Wynkoop Street, Suite 500  
Denver, CO 80202  
County: Horry  
Previous Orders: None  
Permit Number: 26-206-13235  
Violations Cited: S.C. Code Ann. Regs. 61-25

Summary: Chipotle Mexican Grill (Individual/Entity), located in Myrtle Beach, South Carolina, is a restaurant. The Department conducted inspections on June 26, 2017, December 4, 2017, December 14, 2017, February 28, 2018, March 28, 2018, and May 4, 2018. The Individual/Entity has violated the South Carolina Retail Food Establishment Regulation as follows: failed to ensure floors, floor coverings, walls, wall coverings, and ceilings were designed, constructed, and installed so they are smooth and easily cleanable.

Action: The Individual/Entity is required to: operate and maintain the facility in accordance with the requirements of all applicable regulations, including S.C. Regs. 61-25 and pay a civil penalty in the amount of one thousand dollars **(\$1,000.00)**.

148) Order Type and Number: Consent Order 2018-206-01-016  
Order Date: June 20, 2018  
Individual/Entity: **Subway**  
Facility: Subway  
Location: 817 West Front Street  
Iva, SC 29655

Mailing Address: P.O. Box 1626  
Iva, SC 29655  
County: Anderson  
Previous Orders: None  
Permit Number: 04-206-02956  
Violations Cited: S.C. Code Ann. Regs. 61-25

Summary: Subway (Individual/Entity), located in Iva, South Carolina, is a restaurant. The Department conducted inspections on March 9, 2017, February 20, 2018, and April 20, 2018. The Individual/Entity has violated the South Carolina Retail Food Establishment Regulation as follows: failed to maintain proper holding temperatures of time/temperature control for safety foods.

Action: The Individual/Entity is required to: operate and maintain the facility in accordance with the requirements of all applicable regulations, including S.C. Regs. 61-25 and pay a civil penalty in the amount of eight hundred dollars (**\$800.00**).

149) Order Type and Number: Consent Order 2018-206-02-026  
Order Date: June 20, 2018  
Individual/Entity: **Little Caesar's #19**  
Facility: Little Caesar's #19  
Location: 391 College Avenue  
Clemson, SC 29631  
Mailing Address: 26 Parkway Commons Way  
Greer, SC 29650  
County: Pickens  
Previous Orders: None  
Permit Number: 39-206-01612  
Violations Cited: S.C. Code Ann. Regs. 61-25

Summary: Little Caesar's #19 (Individual/Entity), located in Clemson, South Carolina, is a restaurant. The Department conducted inspections on April 26, 2017, May 30, 2017, and March 15, 2018. The Individual/Entity has violated the South Carolina Retail Food Establishment Regulation as follows: failed to ensure written procedures were in place and made available to the Department when the facility uses time as a public health control.

Action: The Individual/Entity is required to: operate and maintain the facility in accordance with the requirements of all applicable regulations, including S.C. Regs. 61-25 and pay a civil penalty in the amount of eight hundred dollars (**\$800.00**).

150) Order Type and Number: Consent Order 2018-206-02-028  
Order Date: June 20, 2018  
Individual/Entity: **Bake and Cook Thai Restaurant**  
Facility: Bake and Cook Thai Restaurant  
Location: 405 College Avenue, Unit 260  
Clemson, SC 29631  
Mailing Address: Same  
County: Pickens  
Previous Orders: None  
Permit Number: 39-206-01890  
Violations Cited: S.C. Code Ann. Regs. 61-25



Summary: Bake and Cook Thai Restaurant (Individual/Entity), located in Clemson, South Carolina is a restaurant. The Department conducted inspections on February 20, 2018, February 21, 2018, and February 22, 2018. The Individual/Entity has violated the South Carolina Retail Food Establishment Regulation as follows: failed to maintain proper holding temperatures of time/temperature control for safety foods.

Action: The Individual/Entity is required to: operate and maintain the facility in accordance with the requirements of all applicable regulations, including S.C. Regs. 61-25 and pay a civil penalty in the amount of eight hundred dollars (**\$800.00**).

151) Order Type and Number: Consent Order 2018-206-03-043  
Order Date: June 20, 2018  
Individual/Entity: **Taylor's Soul Food**  
Facility: Taylor's Soul Food  
Location: 688 Albright Road  
Rock Hill, SC 29730  
Mailing Address: 1219 Dublin Road  
Chester, SC 29706  
County: Greenville  
Previous Orders: None  
Permit Number: 46-206-03491  
Violations Cited: S.C. Code Ann. Regs. 61-25

Summary: Taylor's Soul Food (Individual/Entity), located in Rock Hill, South Carolina, is a restaurant. The Department conducted inspections on April 6, 2017, May 16, 2017, and May 2, 2018. The Individual/Entity has violated the South Carolina Retail Food Establishment Regulation as follows: failed to demonstrate knowledge of foodborne disease prevention by having no priority violations during the inspection; failed to ensure that the handwashing sinks were accessible at all times; failed to provide individual disposable towels at each hand washing sink or group of adjacent handwashing sinks; and failed to maintain proper holding temperatures of time/temperature control for safety foods.

Action: The Individual/Entity is required to: operate and maintain the facility in accordance with the requirements of all applicable regulations, including S.C. Regs. 61-25 and pay a civil penalty in the amount of nine hundred fifty dollars (**\$950.00**).

152) Order Type and Number: Consent Order 2018-206-06-045  
Order Date: June 21, 2018  
Individual/Entity: **Huddle House**  
Facility: Huddle House  
Location: 1611 North Longstreet Street  
Kingstree, SC 29556  
Mailing Address: 2265 Armstrong Court SW  
Conyers, GA 30094  
County: Williamsburg  
Previous Orders: 2016-206-06-065 (\$2,000.00);  
2017-206-06-046 (\$1,200.00);  
2017-206-06-066 (\$1,875.00)  
Permit Number: 45-206-00372  
Violations Cited: S.C. Code Ann. Regs. 61-25

Summary: Huddle House (Individual/Entity), located in Kingstree, South Carolina, is a restaurant. The Department conducted an inspection on April 23, 2018. The Individual/Entity has violated the South Carolina Retail Food Establishment Regulation as follows: failed to maintain proper holding temperatures of time/temperature control for safety foods.

Action: The Individual/Entity is required to: operate and maintain the facility in accordance with the requirements of all applicable regulations, including S.C. Regs. 61-25 and pay a civil penalty in the amount of one thousand dollars **(\$1,000.00)**.

153) Order Type and Number: Consent Order 2018-206-02-019  
Order Date: June 22, 2018  
Individual/Entity: **American Roadside Burgers**  
Facility: American Roadside Burgers  
Location: 301 East McBee Avenue  
Greenville, SC 29601  
Mailing Address: 5821 Fairview Road, Suite 104  
Charlotte, NC 28209  
County: Greenville  
Previous Orders: 2017-206-02-018 (\$800.00)  
Permit Number: 23-206-10831  
Violations Cited: S.C. Code Ann. Regs. 61-25

Summary: American Roadside Burgers (Individual/Entity), located in Greenville, South Carolina, is a restaurant. The Department conducted inspections on September 13, 2016, May 18, 2017, and February 22, 2018. The Individual/Entity has violated the South Carolina Retail Food Establishment Regulation as follows: failed to maintain proper holding temperatures of time/temperature control for safety foods and failed to use effective methods to cool cooked time/temperature control for safety foods.

Action: The Individual/Entity is required to: operate and maintain the facility in accordance with the requirements of all applicable regulations, including S.C. Regs. 61-25 and pay a civil penalty in the amount of one thousand dollars **(\$1,000.00)**.

154) Order Type and Number: Consent Order 2018-206-02-022  
Order Date: June 22, 2018  
Individual/Entity: **Smoke on the Water**  
Facility: Smoke on the Water  
Location: 1 Augusta Street, Suite 202  
Greenville, SC 29601  
Mailing Address: Same  
County: Greenville  
Previous Orders: None  
Permit Number: 23-206-08597  
Violations Cited: S.C. Code Ann. Regs. 61-25

Summary: Smoke on the Water (Individual/Entity), located in Greenville, South Carolina, is a restaurant. The Department conducted inspections on September 15, 2016, May 24, 2017, and March 11, 2018. The Individual/Entity has violated the South Carolina Retail Food Establishment Regulation as follows: failed to ensure that when time without temperature control is used as a public health control, the food in unmarked containers or packages shall be discarded.

Action: The Individual/Entity is required to: operate and maintain the facility in accordance with the requirements of all applicable regulations, including S.C. Regs. 61-25 and pay a civil penalty in the amount of eight hundred dollars (**\$800.00**).

155) Order Type and Number: Consent Order 2018-206-08-007  
Order Date: June 22, 2018  
Individual/Entity: **Rancho Grande**  
Facility: Rancho Grande  
Location: 136 Sea Island Parkway, Suite 4  
Beaufort, SC 29907  
Mailing Address: Same  
County: Beaufort  
Previous Orders: None  
Permit Number: 07-206-02367  
Violations Cited: S.C. Code Ann. Regs. 61-25

Summary: Rancho Grande (Individual/Entity), located in Beaufort, South Carolina, is a restaurant. The Department conducted inspections on July 10, 2017, September 25, 2017, and April 11, 2018. The Individual/Entity has violated the South Carolina Retail Food Establishment Regulation as follows: failed to ensure that outer openings of the retail food establishment were protected against the entry of insects and rodents by filling or closing the holes and other gaps along floors, walls and ceiling; closed tight-fitting windows; and solid, self-closing doors.

Action: The Individual/Entity is required to: operate and maintain the facility in accordance with the requirements of all applicable regulations, including S.C. Regs. 61-25 and pay a civil penalty in the amount of two hundred dollars (**\$200.00**).

156) Order Type and Number: Consent Order 2018-206-01-010  
Order Date: June 25, 2018  
Individual/Entity: **McDonald's**  
Facility: McDonald's  
Location: 101 Electric City Blvd.  
Anderson, SC 29621  
Mailing Address: P.O. Box 4227  
Anderson, SC 29622  
County: Anderson  
Previous Orders: None  
Permit Number: 04-206-03369  
Violations Cited: S.C. Code Ann. Regs. 61-25

Summary: McDonald's (Individual/Entity), located in Anderson, South Carolina, is a restaurant. The Department conducted inspections on March 16, 2016, February 13, 2017, January 23, 2018, and January 31, 2018. The Individual/Entity has violated the South Carolina Retail Food Establishment Regulation as follows: failed to maintain proper holding temperatures of time/temperature control for safe foods and failed to ensure written procedures were in place and made available to the Department when the facility uses time as a public health control.

Action: The Individual/Entity is required to: operate and maintain the facility in accordance with the requirements of all applicable regulations, including S.C. Regs. 61-25 and pay a civil penalty in the amount of one thousand, six hundred dollars (**\$1,600.00**).

157) Order Type and Number: Consent Order 2018-206-07-011  
Order Date: June 25, 2018  
Individual/Entity: **Steel City Pizza Company**  
Facility: Steel City Pizza Company  
Location: 1440 Ben Sawyer Blvd.  
Mount Pleasant, SC 29464  
Mailing Address: Same  
County: Charleston  
Previous Orders: None  
Permit Number: 10-206-05442  
Violations Cited: S.C. Code Ann. Regs. 61-25

Summary: Steel City Pizza Company (Individual/Entity), located in Mount Pleasant, South Carolina is a restaurant. The Department conducted inspections on April 5, 2018, April 13, 2018, and April 16, 2018. The Individual/Entity has violated the South Carolina Retail Food Establishment Regulation as follows: failed to use effective methods to cool cooked time/temperature control for safety foods.

Action: The Individual/Entity is required to: operate and maintain the facility in accordance with the requirements of all applicable regulations, including S.C. Regs. 61-25 and pay a civil penalty in the amount of four hundred dollars **(\$400.00)**.

158) Order Type and Number: Consent Order 2018-206-03-031  
Order Date: June 26, 2018  
Individual/Entity: **Waffle House #145**  
Facility: Waffle House #145  
Location: 2345 Broad River Road  
Columbia, SC 29210  
Mailing Address: P.O. Box 6450  
Norcross, GA 30091  
County: Richland  
Previous Orders: None  
Permit Number: 40-206-00727  
Violations Cited: S.C. Code Ann. Regs. 61-25

Summary: Waffle House #145 (Individual/Entity), located in Columbia, South Carolina, is a restaurant. The Department conducted inspections on March 28, 2017, April 19, 2017, and March 29, 2018. The Individual/Entity has violated the South Carolina Retail Food Establishment Regulation as follows: failed to demonstrate knowledge of foodborne disease prevention by having no priority violations during the inspection and failed to ensure employees wash hands after engaging in activities that contaminate their hands.

Action: The Individual/Entity is required to: operate and maintain the facility in accordance with the requirements of all applicable regulations, including S.C. Regs. 61-25 and pay a civil penalty in the amount of eight hundred dollars **(\$800.00)**.

159) Order Type and Number: Consent Order 2018-206-03-040  
Order Date: June 26, 2018  
Individual/Entity: **El Jimador**  
Facility: El Jimador  
Location: 108-J Scarborough Drive  
Lexington, SC 29072

Mailing Address: Same  
County: Lexington  
Previous Orders: None  
Permit Number: 32-206-06481  
Violations Cited: S.C. Code Ann. Regs. 61-25

Summary: El Jimador (Individual/Entity), located in Lexington, South Carolina, is a restaurant. The Department conducted inspections on March 7, 2017, May 4, 2017, and April 4, 2018. The Individual/Entity has violated the South Carolina Retail Food Establishment Regulation as follows: failed to maintain proper holding temperatures of time/temperature control for safety foods.

Action: The Individual/Entity is required to: operate and maintain the facility in accordance with the requirements of all applicable regulations, including S.C. Regs. 61-25 and pay a civil penalty in the amount of eight hundred dollars (**\$800.00**).

160) Order Type and Number: Consent Order 2018-206-03-044  
Order Date: June 26, 2018  
Individual/Entity: **McAlister's Deli**  
Facility: McAlister's Deli  
Location: 335 Herlong Avenue, Suite 201  
Rock Hill, SC 29732  
Mailing Address: Same  
County: York  
Previous Orders: None  
Permit Number: 46-206-01974  
Violations Cited: S.C. Code Ann. Regs. 61-25

Summary: McAlister's Deli (Individual/Entity), located in Rock Hill, South Carolina, is a restaurant. The Department conducted inspections on January 30, 2017, June 5, 2017, and April 25, 2018. Individual/Entity has violated the South Carolina Retail Food Establishment Regulation as follows: failed to maintain proper holding temperatures of time/temperature control for safety foods.

Action: The Individual/Entity is required to: operate and maintain the facility in accordance with the requirements of all applicable regulations, including S.C. Regs. 61-25 and pay a civil penalty in the amount of eight hundred dollars (**\$800.00**).

161) Order Type and Number: Consent Order 2018-206-06-047  
Order Date: June 26, 2018  
Individual/Entity: **Mulan Japanese**  
Facility: Mulan Japanese  
Location: 1225 38<sup>th</sup> Avenue North  
Myrtle Beach, SC 29577  
Mailing Address: Same  
County: Horry  
Previous Orders: None  
Permit Number: 26-206-12737  
Violations Cited: S.C. Code Ann. Regs. 61-25

Summary: Mulan Japanese (Individual/Entity), located in Myrtle Beach, South Carolina, is a restaurant. The Department conducted inspections on June 1, 2017, November 22, 2017, and May 15, 2018. The Individual/Entity has violated the South Carolina Retail Food Establishment Regulation as follows:

failed to comply with the HACCP plan and procedures that are submitted and approved as a basis for the modification or waiver and maintain and provide to the Department, upon request, records that demonstrate the HACCP plan is being employed.

Action: The Individual/Entity is required to: operate and maintain the facility in accordance with the requirements of all applicable regulations, including S.C. Regs. 61-25 and pay a civil penalty in the amount of eight hundred dollars (**\$800.00**).

162) Order Type and Number: Consent Order 2018-206-03-046  
Order Date: July 2, 2018  
Individual/Entity: **Lizard's Thicket #16**  
Facility: Lizard's Thicket #16  
Location: 621 West Main Street  
Lexington, SC 29072  
Mailing Address: 1036 Market Street  
Columbia, SC 29201  
County: Lexington  
Previous Orders: None  
Permit Number: 32-206-01379  
Violations Cited: S.C. Code Ann. Regs. 61-25

Summary: Lizard's Thicket #16 (Individual/Entity), located in Lexington, South Carolina, is a restaurant. The Department conducted inspections on March 22, 2017, May 11, 2018, and April 30, 2018. The Individual/Entity has violated the South Carolina Retail Food Establishment Regulation as follows: failed to maintain proper holding temperatures of time/temperature control for safety foods.

Action: The Individual/Entity is required to: operate and maintain the facility in accordance with the requirements of all applicable regulations, including S.C. Regs. 61-25, and pay a civil penalty in the amount of eight hundred dollars (**\$800.00**).

163) Order Type and Number: Consent Order 2018-206-03-048  
Order Date: July 2, 2018  
Individual/Entity: **Little Caesars Pizza**  
Facility: Little Caesars Pizza  
Location: 7249 Saint Andrews Road  
Columbia, SC 29212  
Mailing Address: P.O. Box 290743  
Columbia, SC 29229  
County: Lexington  
Previous Orders: None  
Permit Number: 32-206-06477  
Violations Cited: S.C. Code Ann. Regs. 61-25

Summary: Little Caesars Pizza (Individual/Entity), located in Columbia, South Carolina, is a restaurant. The Department conducted inspections on June 26, 2017, July 6, 2017, and May 2, 2018. The Individual/Entity has violated the South Carolina Retail Food Establishment Regulation as follows: failed to ensure written procedures were in place and made available to the Department when the facility uses Time as a Public Health Control.

Action: The Individual/Entity is required to: operate and maintain the facility in accordance with the requirements of all applicable regulations, including S.C. Regs. 61-25, and pay a civil penalty in the amount of eight hundred dollars (**\$800.00**).

164) Order Type and Number: Consent Order 2018-206-03-053  
Order Date: July 2, 2018  
Individual/Entity: **KJ's Market Deli/Bakery #36**  
Facility: KJ's Market Deli/Bakery #36  
Location: 543 Saint Andrews Road  
Columbia, SC 29210  
Mailing Address: P.O. Box 1629  
Lake City, SC 29560  
County: Lexington  
Previous Orders: 2015-206-03-031 (\$800.00)  
2016-206-03-110 (\$1,200.00)  
Permit Number: 32-206-06209  
Violations Cited: S.C. Code Ann. Regs. 61-25

Summary: KJ's Market Deli/Bakery #36 (Individual/Entity), located in Columbia, South Carolina, is a deli/bakery. The Department conducted an inspection on May 15, 2018. The Individual/Entity has violated the South Carolina Retail Food Establishment Regulation as follows: failed to maintain proper hot temperatures of time/temperature control for safety foods.

Action: The Individual/Entity is required to: operate and maintain the facility in accordance with the requirements of all applicable regulations, including S.C. Regs. 61-25, and pay a civil penalty in the amount of one thousand dollars (**\$1,000.00**).

165) Order Type and Number: Consent Order 2018-206-03-065  
Order Date: July 3, 2018  
Individual/Entity: **Lizard's Thicket**  
Facility: Lizard's Thicket  
Location: 711-1 University Village Road  
Blythewood, SC 29016  
Mailing Address: Same  
County: Richland  
Previous Orders: 2015-206-03-112 (\$800.00)  
Permit Number: 40-206-06288  
Violations Cited: S.C. Code Ann. Regs. 61-25

Summary: Lizard's Thicket (Individual/Entity), located in Blythewood, South Carolina, is a restaurant. The Department conducted inspections on May 19, 2016, March 29, 2017, and March 20, 2018. The Individual/Entity has violated the South Carolina Retail Food Establishment Regulation as follows: failed to properly cool cooked time/temperature control for safety foods and failed to use effective methods to cool cooked time/temperature control for safety foods.

Action: The Individual/Entity is required to: operate and maintain the facility in accordance with the requirements of all applicable regulations, including S.C. Regs. 61-25, and pay a civil penalty in the amount of eight hundred dollars (**\$800.00**).

166) Order Type and Number: Consent Order 2018-206-01-018  
Order Date: July 5, 2018  
Individual/Entity: **Redi Mart**  
Facility: Redi Mart  
Location: 6731 Highway 81 South  
Starr, SC 29684  
Mailing Address: 105 Tinsley Drive  
Anderson, SC 29621  
County: Anderson  
Previous Orders: None  
Permit Number: 04-206-04299  
Violations Cited: S.C. Code Ann. Regs. 61-25

Summary: Redi Mart (Individual/Entity), located in Starr, South Carolina, is a convenience store. The Department conducted inspections on June 22, 2016, June 9, 2017, and May 7, 2018. The Individual/Entity has violated the South Carolina Retail Food Establishment Regulation as follows: failed to protect food from contamination by storing in a clean, dry location, where it is not exposed to splash, dust, or other contamination, at least 6 inches above the floor.

Action: The Individual/Entity is required to: operate and maintain the facility in accordance with the requirements of all applicable regulations, including S.C. Regs. 61-25, and pay a civil penalty in the amount of two hundred dollars **(\$200.00)**.

167) Order Type and Number: Consent Order 2018-206-02-029  
Order Date: July 5, 2018  
Individual/Entity: **Trattoria Giorgio**  
Facility: Trattoria Giorgio  
Location: 121 South Main Street  
Greenville, SC 29601  
Mailing Address: Same  
County: Greenville  
Previous Orders: None  
Permit Number: 23-206-06419  
Violations Cited: S.C. Code Ann. Regs. 61-25

Summary: Trattoria Giorgio (Individual/Entity), located in Greenville, South Carolina, is a restaurant. The Department conducted inspections on October 3, 2016, July 12, 2017, and April 24, 2018. The Individual/Entity has violated the South Carolina Retail Food Establishment Regulation as follows: failed to ensure that when time without temperature control is used as a public health control, the food in unmarked containers or packages shall be discarded.

Action: The Individual/Entity is required to: operate and maintain the facility in accordance with the requirements of all applicable regulations, including S.C. Regs. 61-25, and pay a civil penalty in the amount of eight hundred dollars **(\$800.00)**.

168) Order Type and Number: Consent Order 2018-206-02-034  
Order Date: July 5, 2018  
Individual/Entity: **Gringo's**  
Facility: Gringo's  
Location: 11 West Camperdown Way  
Greenville, SC 29601



Mailing Address: Same  
County: Greenville  
Previous Orders: None  
Permit Number: 23-206-10777  
Violations Cited: S.C. Code Ann. Regs. 61-25

Summary: Gringo's (Individual/Entity), located in Greenville, South Carolina, is a restaurant. The Department conducted inspections on November 28, 2016, August 28, 2017, and May 23, 2018. Individual/Entity has violated the South Carolina Retail Food Establishment Regulation as follows: failed to ensure that when time without temperature control is used as a public health control, the food in unmarinated containers or packages shall be discarded.

Action: The Individual/Entity is required to: operate and maintain the facility in accordance with the requirements of all applicable regulations, including S.C. Regs. 61-25, and pay a civil penalty in the amount of eight hundred dollars (**\$800.00**).

169) Order Type and Number: Consent Order 2018-206-02-035  
Order Date: July 5, 2018  
Individual/Entity: **Western Sizzlin Steak House**  
Facility: Western Sizzlin Steak House  
Location: 898 Tiger Boulevard  
Clemson, SC 29631  
Mailing Address: Same  
County: Pickens  
Previous Orders: None  
Permit Number: 39-206-00417  
Violations Cited: S.C. Code Ann. Regs. 61-25

Summary: Western Sizzlin Steak House (Individual/Entity), located in Clemson, South Carolina, is a restaurant. The Department conducted inspections on February 13, 2018, May 17, 2018, and May 24, 2018. The Individual/Entity has violated the South Carolina Retail Food Establishment Regulation as follows: failed to maintain proper holding temperatures of time/temperature control for safety foods.

Action: The Individual/Entity is required to: operate and maintain the facility in accordance with the requirements of all applicable regulations, including S.C. Regs. 61-25, and pay a civil penalty in the amount of eight hundred dollars (**\$800.00**).

170) Order Type and Number: Consent Order 2018-206-03-049  
Order Date: July 5, 2018  
Individual/Entity: **Chinese Kitchen**  
Facility: Chinese Kitchen  
Location: 419 East Liberty Street  
York, SC 29745  
Mailing Address: Same  
County: York  
Previous Orders: None  
Permit Number: 46-206-00521  
Violations Cited: S.C. Code Ann. Regs. 61-25

Summary: Chinese Kitchen (Individual/Entity), located in York, South Carolina, is a restaurant. The Department conducted inspections on June 20, 2017, December 28, 2017, and April 17, 2018. The

Individual/Entity has violated the South Carolina Retail Food Establishment Regulation as follows: failed to ensure that when time without temperature control is used as a public health control, the food in unmarinated containers or packages shall be discarded.

Action: The Individual/Entity is required to: operate and maintain the facility in accordance with the requirements of all applicable regulations, including S.C. Regs. 61-25, and pay a civil penalty in the amount of eight hundred dollars (**\$800.00**).

171) Order Type and Number: Consent Order 2018-206-06-054  
Order Date: July 5, 2018  
Individual/Entity: **Original Shuckers Raw Bar**  
Facility: Original Shuckers Raw Bar  
Location: 300 North Kings Highway  
Myrtle Beach, SC 29577  
Mailing Address: Same  
County: Horry  
Previous Orders: 2017-206-06-116 (\$400.00)  
Permit Number: 26-206-07497  
Violations Cited: S.C. Code Ann. Regs. 61-25

Summary: Original Shuckers Raw Bar (Individual/Entity), located in Myrtle Beach, South Carolina is a restaurant. The Department conducted inspections on September 18, 2017, January 12, 2018, and May 14, 2018. The Individual/Entity has violated the South Carolina Retail Food Establishment Regulation as follows: failed to ensure that during pauses in food preparation or dispensing, food preparation and dispensing utensils were stored in the food with their handles above the top of the food.

Action: The Individual/Entity is required to: operate and maintain the facility in accordance with the requirements of all applicable regulations, including S.C. Regs. 61-25, and pay a civil penalty in the amount of two hundred dollars (**\$200.00**).

172) Order Type and Number: Consent Order 2018-206-01-020  
Order Date: July 9, 2018  
Individual/Entity: **Chili's Grill & Bar #557**  
Facility: Chili's Grill & Bar #557  
Location: 3803 Clemson Boulevard  
Anderson, SC 29621  
Mailing Address: 6820 LBJ Freeway  
Dallas, TX 75201  
County: Anderson  
Previous Orders: None  
Permit Number: 04-206-03508  
Violations Cited: S.C. Code Ann. Regs. 61-25

Summary: Chili's Grill & Bar #557 (Individual/Entity), located in Anderson, South Carolina, is a restaurant. The Department conducted inspections on July 28, 2016, June 26, 2017, and April 17, 2018. The Individual/Entity has violated the South Carolina Retail Food Establishment Regulation as follows: failed to properly cool cooked time/temperature control for safety foods and failed to use effective methods to cool cooked time/temperature control for safety foods.

Action: The Individual/Entity is required to: operate and maintain the facility in accordance with the requirements of all applicable regulations, including S.C. Regs. 61-25, and pay a civil penalty in the amount of eight hundred dollars (**\$800.00**).

173) Order Type and Number: Consent Order 2018-206-01-022  
Order Date: July 9, 2018  
Individual/Entity: **Anderson Express**  
Facility: Anderson Express  
Location: 3101 North Main Street  
Anderson, SC 29625  
Mailing Address: Same  
County: Anderson  
Previous Orders: None  
Permit Number: 04-206-01351  
Violations Cited: S.C. Code Ann. Regs. 61-25

Summary: Anderson Express (Individual/Entity), located in Anderson, South Carolina, is a restaurant. The Department conducted inspections on January 30, 2017, June 12, 2017, and June 1, 2018. The Individual/Entity has violated the South Carolina Retail Food Establishment Regulation as follows: failed to clearly mark the date by which food shall be consumed on the premises, sold, or discarded when held at a temperature of 41°F or less for a maximum of seven (7) days. This applies only to refrigerated, ready-to-eat, time/temperature control for safety foods prepared and held in a food establishment for more than twenty-four (24) hours. The facility also failed to ensure that when time without temperature control is used as a public health control, the food in unmarked containers or packages shall be discarded, failed to maintain the physical facilities in good repair, and failed to ensure the plumbing system is repaired according to law and maintained in good repair.

Action: The Individual/Entity is required to: operate and maintain the facility in accordance with the requirements of all applicable regulations, including S.C. Regs. 61-25, and pay a civil penalty in the amount of one thousand dollars (**\$1,000.00**).

174) Order Type and Number: Consent Order 2018-206-03-047  
Order Date: July 9, 2018  
Individual/Entity: **Veer Mart**  
Facility: Veer Mart  
Location: 2568 Highway 378  
Gilbert, SC 29054  
Mailing Address: Same  
County: Lexington  
Previous Orders: None  
Permit Number: 32-206-06542  
Violations Cited: S.C. Code Ann. Regs. 61-25

Summary: Veer Mart (Individual/Entity), located in Gilbert, South Carolina, is a convenience store. The Department conducted inspections on May 17, 2017, March 29, 2018, and April 6, 2018. The Individual/Entity has violated the South Carolina Retail Food Establishment Regulation as follows: failed to maintain proper holding temperatures of time/temperature control for safety foods.

Action: The Individual/Entity is required to: operate and maintain the facility in accordance with the requirements of all applicable regulations, including S.C. Regs. 61-25, and pay a civil penalty in the amount of eight hundred dollars (**\$800.00**).

175) Order Type and Number: Consent Order 2018-206-06-049  
Order Date: July 9, 2018  
Individual/Entity: **Jersey Mike's Subs**  
Facility: Jersey Mike's Subs  
Location: 2602 North Kings Highway  
Myrtle Beach, SC 29577  
Mailing Address: P.O. Box 1007  
Myrtle Beach, SC 29598  
County: Horry  
Previous Orders: None  
Permit Number: 26-206-12366  
Violations Cited: S.C. Code Ann. Regs. 61-25

Summary: Jersey Mike's Subs (Individual/Entity), located in Myrtle Beach, South Carolina, is a restaurant. The Department conducted inspections on September 12, 2016, July 31, 2017, and May 22, 2018. The Individual/Entity has violated the South Carolina Retail Food Establishment Regulation as follows: failed to maintain proper holding temperatures of time/temperature control for safety foods.

Action: The Individual/Entity is required to: operate and maintain the facility in accordance with the requirements of all applicable regulations, including S.C. Regs. 61-25, and pay a civil penalty in the amount of eight hundred dollars (**\$800.00**).

176) Order Type and Number: Consent Order 2018-206-01-012  
Order Date: July 10, 2018  
Individual/Entity: **High Volume #2**  
Facility: High Volume #2  
Location: 2401 Williamston Road  
Anderson, SC 29621  
Mailing Address: P.O. Box 403  
Anderson, SC 29622  
County: Anderson  
Previous Orders: None  
Permit Number: 04-206-03571  
Violations Cited: S.C. Code Ann. Regs. 61-25

Summary: High Volume #2 (Individual/Entity), located in Anderson, South Carolina, is a restaurant. The Department conducted inspections on January 24, 2017, February 3, 2017, February 13, 2017, February 27, 2017, January 22, 2018, and February 1, 2018. The Individual/Entity has violated the South Carolina Retail Food Establishment Regulation as follows: failed to provide individual disposable towels at each hand washing sink or group of adjacent handwashing sinks, failed to ensure that light bulbs were shielded, coated, or otherwise shatter-resistant in areas where there is exposed food, clean equipment, utensils and linens, and failed to protect food from contamination that may result from a facility or source not specified in the regulation.

Action: The Individual/Entity is required to: operate and maintain the facility in accordance with the requirements of all applicable regulations, including S.C. Regs. 61-25, and pay a civil penalty in the amount of two thousand dollars (**\$2,000.00**).

177) Order Type and Number: Consent Order 2018-206-06-052  
Order Date: July 10, 2018  
Individual/Entity: **New China Buffet DBA Lucky Cho**  
Facility: New China Buffet DBA Lucky Cho  
Location: 1700 Highway 17 North  
Myrtle Beach, SC 29575  
Mailing Address: Same  
County: Horry  
Previous Orders: 2016-206-06-089 (\$800.00)  
2017-206-06-017 (\$1,200.00)  
Permit Number: 26-206-13065  
Violations Cited: S.C. Code Ann. Regs. 61-25

Summary: New China Buffet DBA Lucky Cho (Individual/Entity), located in Myrtle Beach, South Carolina, is a restaurant. The Department conducted inspections on January 9, 2018, and May 21, 2018. The Individual/Entity has violated the South Carolina Retail Food Establishment Regulation as follows: fa to maintain proper holding temperatures of time/temperature control for safety foods.

Action: The Individual/Entity is required to: operate and maintain the facility in accordance with the requirements of all applicable regulations, including S.C. Regs. 61-25, and pay a civil penalty in the amount of two thousand dollars **(\$2,000.00)**.

178) Order Type and Number: Consent Order 2018-206-01-023  
Order Date: July 12, 2018  
Individual/Entity: **Wok N Roll**  
Facility: Wok N Roll  
Location: 1615 East Greenville Street  
Anderson, SC 29621  
Mailing Address: Same  
County: Anderson  
Previous Orders: None  
Permit Number: 04-206-03214  
Violations Cited: S.C. Code Ann. Regs. 61-25

Summary: Wok N Roll (Individual/Entity), located in Anderson, South Carolina, is a restaurant. The Department conducted inspections on April 20, 2016, April 18, 2017, April 26, 2017, April 16, 2018, and May 15, 2018. The Individual/Entity has violated the South Carolina Retail Food Establishment Regulation as follows: failed to ensure that during pauses in food preparation or dispensing, food preparation and dispensing utensils were stored in the food with their handles above the top of the food; failed to protect food from contamination by storing in a clean, dry location, where it is not exposed to splash, dust, or other contamination, at least 6 inches above the floor, failed to keep food contact surfaces nonfood contact surfaces, and utensils clean and free of accumulation of dust, dirt, food residue and other debris, failed to ensure that outer openings of the retail food establishment were protected against the entry of insects and rodents by filling or closing the holes and other gaps along floors, walls and ceiling, closed tight-fitting windows, and solid, self-closing doors, failed to clean the physical facilities as often as necessary to keep them clean; failed to ensure that cleaned equipment and utensils, laundered linens, and single-use articles shall be stored in a clean, dry location; where they are not exposed to splash, dust, or other contamination, and at least 6 inches off the floor, failed to ensure that intake and exhaust air ducts shall be cleaned and filters changed so they are not a source of contamination by dust, dirt, and other materials and if vented to the outside, ventilation systems may not create a public health hazard or nuisance or unlawful discharge and failed to ensure that plumbing fixtures such as handwashing sinks, toilets and urinals shall be cleaned as often as necessary to keep them clean.

Action: The Individual/Entity is required to: operate and maintain the facility in accordance with the requirements of all applicable regulations, including S.C. Regs. 61-25, and pay a civil penalty in the amount of one thousand, eight hundred dollars (**\$1,800.00**).

179) Order Type and Number: Consent Order 2018-206-03-060  
Order Date: July 12, 2018  
Individual/Entity: **Applebee's #602**  
Facility: Applebee's #602  
Location: 2344 Broad River Road  
Columbia, SC 29210  
Mailing Address: 170 Wind Chime Court  
Raleigh, NC 29615  
County: Richland  
Previous Orders: None  
Permit Number: 40-206-06855  
Violations Cited: S.C. Code Ann. Regs. 61-25

Summary: Applebee's #602 (Individual/Entity), located in Columbia, South Carolina, is a restaurant. The Department conducted inspections on August 12, 2016, June 13, 2017, and May 23, 2018. The Individual/Entity has violated the South Carolina Retail Food Establishment Regulation as follows: failed to maintain proper holding temperatures of time/temperature control for safety foods.

Action: The Individual/Entity is required to: operate and maintain the facility in accordance with the requirements of all applicable regulations, including S.C. Regs. 61-25, and pay a civil penalty in the amount of eight hundred dollars (**\$800.00**).

180) Order Type and Number: Consent Order 2018-206-02-020  
Order Date: July 13, 2018  
Individual/Entity: **Project Host**  
Facility: Project Host  
Location: 525 South Academy Street  
Greenville, SC 29601  
Mailing Address: P.O. Box 345  
Greenville, SC 29602  
County: Greenville  
Previous Orders: None  
Permit Number: 23-206-05927  
Violations Cited: S.C. Code Ann. Regs. 61-25

Summary: Project Host (Individual/Entity), located in Greenville, South Carolina, is a restaurant. The Department conducted inspections on February 28, 2017, June 7, 2017, and March 22, 2018. The Individual/Entity has violated the South Carolina Retail Food Establishment Regulation as follows: failed to ensure that when time without temperature control is used as a public health control, the food in unmarked containers or packages shall be discarded, and failed to protect food from contamination by storing in a clean, dry location, where it is not exposed to splash, dust, or other contamination, at least 6 inches above the floor.

Action: The Individual/Entity is required to: operate and maintain the facility in accordance with the requirements of all applicable regulations, including S.C. Regs. 61-25, and pay a civil penalty in the amount of eight hundred dollars (**\$800.00**).

181) Order Type and Number: Consent Order 2018-206-03-036  
Order Date: July 13, 2018  
Individual/Entity: **Hardees #1501760**  
Facility: Hardees #1501760  
Location: 3014 Charleston Highway  
Cayce, SC 29172  
Mailing Address: 1 City Boulevard West #1450  
Orange, CA 92868  
County: Lexington  
Previous Orders: None  
Permit Number: 32-206-06399  
Violations Cited: S.C. Code Ann. Regs. 61-25

Summary: Hardees #1501760 (Individual/Entity), located in Cayce, South Carolina, is a restaurant. The Department conducted inspections on June 17, 2016, May 31, 2017, and April 17, 2018. The Individual/Entity has violated the South Carolina Retail Food Establishment Regulation as follows: failed to keep food contact surfaces, nonfood contact surfaces, and utensils clean and free of accumulation of dust, dirt, food residue and other debris.

Action: The Individual/Entity is required to: operate and maintain the facility in accordance with the requirements of all applicable regulations, including S.C. Regs. 61-25, and pay a civil penalty in the amount of two hundred dollars **(\$200.00)**.

182) Order Type and Number: Consent Order 2018-206-07-018  
Order Date: July 15, 2018  
Individual/Entity: **The Junction Kitchen & Provisions**  
Facility: The Junction Kitchen & Provisions  
Location: 4438 Spruill Avenue  
North Charleston, SC 29405  
Mailing Address: Same  
County: Charleston  
Previous Orders: None  
Permit Number: 10-206-09427  
Violations Cited: S.C. Code Ann. Regs. 61-25

Summary: The Junction Kitchen & Provisions (Individual/Entity), located in North Charleston, South Carolina, is a restaurant. The Department conducted inspections on February 15, 2017, September 22, 2017, September 26, 2017, and May 8, 2018. The Individual/Entity has violated the South Carolina Retail Food Establishment Regulation as follows: failed to maintain proper holding temperatures and time/temperature control for safety foods and failed to ensure that the chemical sanitizers, including chemical sanitizing solutions generated on-site, and other chemical antimicrobials applied to food-contact surfaces shall meet the requirements specified in 40 CFR 180.940 and 40 CFR 180.2020.

Action: The Individual/Entity is required to: operate and maintain the facility in accordance with the requirements of all applicable regulations, including S.C. Regs. 61-25, and pay a civil penalty in the amount of one thousand, six hundred dollars **(\$1,600.00)**.

183) Order Type and Number: Consent Order 2018-206-01-021  
Order Date: July 16, 2018  
Individual/Entity: **Fatz Café #35**  
Facility: Fatz Café #35  
Location: 105 Interstate Boulevard  
Anderson, SC 29621  
Mailing Address: 4324 Wade Hampton Boulevard, Suite B  
Taylors, SC 29687  
County: Anderson  
Previous Orders: 2016-206-01-011 (\$800.00);  
2016-206-01-049 (\$1,500.00)  
Permit Number: 04-206-03407  
Violations Cited: S.C. Code Ann. Regs. 61-25

Summary: Fatz Café #35 (Individual/Entity), located in Anderson, South Carolina, is a restaurant. The Department conducted inspections on October 11, 2016, September 20, 2017, and May 15, 2018. The Individual/Entity has violated the South Carolina Retail Food Establishment Regulation as follows: failed to keep food contact surfaces, nonfood contact surfaces, and utensils clean and free of accumulation of dirt, food residue and other debris and failed to demonstrate knowledge of foodborne disease prevention by having no priority violations during the inspection.

Action: The Individual/Entity is required to: operate and maintain the facility in accordance with the requirements of all applicable regulations, including S.C. Regs. 61-25, and pay a civil penalty in the amount of eight hundred dollars (**\$800.00**).

184) Order Type and Number: Consent Order 2018-206-02-031  
Order Date: July 16, 2018  
Individual/Entity: **Blockhouse Restaurant**  
Facility: Blockhouse Restaurant  
Location: 1619 Augusta Road  
Greenville, SC 29601  
Mailing Address: Same  
County: Greenville  
Previous Orders: 2017-206-02-003 (\$800.00);  
2017-206-02-025 (\$750.00)  
Permit Number: 23-206-03818  
Violations Cited: S.C. Code Ann. Regs. 61-25

Summary: Blockhouse Restaurant (Individual/Entity), located in Greenville, South Carolina, is a restaurant. The Department conducted inspections on December 15, 2016, August 10, 2017, May 17, 2018, and May 21, 2018. The Individual/Entity has violated the South Carolina Retail Food Establishment Regulation as follows: failed to maintain proper holding temperatures of time/temperature control for safe foods and failed to ensure that when time without temperature control is used as a public health control the food in unmarked containers or packages shall be discarded.

Action: The Individual/Entity is required to: operate and maintain the facility in accordance with the requirements of all applicable regulations, including S.C. Regs. 61-25, and pay a civil penalty in the amount of two thousand dollars (**\$2,000.00**).



185) Order Type and Number: Consent Order 2018-206-03-050  
Order Date: July 16, 2018  
Individual/Entity: **Dixie Food Mart**  
Facility: Dixie Food Mart  
Location: 3586 Pageland Highway  
Lancaster, SC 29720  
Mailing Address: Same  
County: Lancaster  
Previous Orders: None  
Permit Number: 29-206-01160  
Violations Cited: S.C. Code Ann. Regs. 61-25

Summary: Dixie Food Mart (Individual/Entity), located in Lancaster, South Carolina, is a convenience store. The Department conducted inspections on March 16, 2017, May 11, 2017, and May 1, 2018. The Individual/Entity has violated the South Carolina Retail Food Establishment Regulation as follows: failed to demonstrate knowledge of foodborne disease prevention by having no priority violations during the inspection and failed to ensure that when time without temperature control is used as a public health control, the food in unmarked containers or packages shall be discarded.

Action: The Individual/Entity is required to: operate and maintain the facility in accordance with the requirements of all applicable regulations, including S.C. Regs. 61-25, and pay a civil penalty in the amount of eight hundred dollars (**\$800.00**).

186) Order Type and Number: Consent Order 2018-206-03-057  
Order Date: July 16, 2018  
Individual/Entity: **Cruisin Ruebens**  
Facility: Cruisin Ruebens  
Location: 8390 Charlotte Highway, Suite 800  
Indian Land, SC 29707  
Mailing Address: Same  
County: Lancaster  
Previous Orders: None  
Permit Number: 29-206-01466  
Violations Cited: S.C. Code Ann. Regs. 61-25

Summary: Cruisin Ruebens (Individual/Entity), located in Indian Land, South Carolina, is a restaurant. The Department conducted inspections on May 24, 2017, May 16, 2018, and May 22, 2018. The Individual/Entity has violated the South Carolina Retail Food Establishment Regulation as follows: failed to maintain proper holding temperatures of time/temperature control for safety foods.

Action: The Individual/Entity is required to: operate and maintain the facility in accordance with the requirements of all applicable regulations, including S.C. Regs. 61-25, and pay a civil penalty in the amount of eight hundred dollars (**\$800.00**).

187) Order Type and Number: Consent Order 2018-206-03-068  
Order Date: July 16, 2018  
Individual/Entity: **Rositas Mexican Grill**  
Facility: Rositas Mexican Grill  
Location: 42 North Congress Street  
York, SC 29745  
Mailing Address: Same

County: York  
Previous Orders: None  
Permit Number: 46-206-03472  
Violations Cited: S.C. Code Ann. Regs. 61-25

Summary: Rositas Mexican Grill (Individual/Entity), located in York, South Carolina, is a restaurant. The Department conducted inspections on April 6, 2018, April 10, 2018, and May 24, 2018. The Individual/Entity has violated the South Carolina Retail Food Establishment Regulation as follows: failed to properly cool cooked time/temperature control for safety foods and failed to use effective methods to cool cooked time/temperature control for safety foods.

Action: The Individual/Entity is required to: operate and maintain the facility in accordance with the requirements of all applicable regulations, including S.C. Regs. 61-25, and pay a civil penalty in the amount of eight hundred dollars (**\$800.00**).

188) Order Type and Number: Consent Order 2018-206-04-002  
Order Date: July 16, 2018  
Individual/Entity: **Cici's Pizza**  
Facility: Cici's Pizza  
Location: 1945 West Palmetto Street  
Florence, SC 29501  
Mailing Address: 430 Ramsey Street  
Fayetteville, NC 28301  
County: Florence  
Previous Orders: None  
Permit Number: 21-206-02822  
Violations Cited: S.C. Code Ann. Regs. 61-25

Summary: Cici's Pizza (Individual/Entity), located in Florence, South Carolina, is a restaurant. The Department conducted inspections on March 15, 2018, March 23, 2018, and April 2, 2018. The Individual/Entity has violated the South Carolina Retail Food Establishment Regulation as follows: failed to ensure written procedures were in place and made available to the Department when the facility uses T as a Public Health Control, failed to maintain proper holding temperatures of time/temperature control for safety foods and failed to demonstrate knowledge of foodborne disease prevention by having no priority violations during the inspection.

Action: The Individual/Entity is required to: operate and maintain the facility in accordance with the requirements of all applicable regulations, including S.C. Regs. 61-25, and pay a civil penalty in the amount of seven hundred fifty dollars (**\$750.00**).

189) Order Type and Number: Consent Order 2018-206-06-055  
Order Date: July 18, 2018  
Individual/Entity: **Comfort Suites**  
Facility: Comfort Suites  
Location: 2480 Highway 501 East  
Conway, SC 29526  
Mailing Address: Same  
County: Horry  
Previous Orders: None  
Permit Number: 26-206-10400  
Violations Cited: S.C. Code Ann. Regs. 61-25

Summary: Comfort Suites (Individual/Entity), located in Conway, South Carolina, is a restaurant. The Department conducted inspections on October 28, 2016, August 2, 2017, and May 17, 2018. The Individual/Entity has violated the South Carolina Retail Food Establishment Regulation as follows: failed to provide individual disposable towels at each hand washing sink or group of adjacent handwashing sinks and failed to ensure a waste receptacle is located at each lavatory or group of adjacent lavatories.

Action: The Individual/Entity is required to: operate and maintain the facility in accordance with the requirements of all applicable regulations, including S.C. Regs. 61-25, and pay a civil penalty in the amount of four hundred dollars **(\$400.00)**.

190) Order Type and Number: Consent Order 2018-204-03-001  
Order Date: July 20, 2018  
Individual/Entity: **La Calentana/Victor Cafe**  
Facility: La Calentana/Victor Cafe  
Location: 3674 Highway 51  
Fort Mill, SC 29715  
Mailing Address: Same  
County: York  
Previous Orders: None  
Permit Number: 46-204-03195  
Violations Cited: S.C. Code Ann. Regs. 61-25

Summary: La Calentana/Victor Café (Individual/Entity), located in Fort Mill, South Carolina, is a mobile food unit. The Department conducted inspections on August 12, 2016, August 2, 2017, August 1, 2017, March 28, 2018, April 6, 2018, April 13, 2018, April 23, 2018, May 2, 2018, May 4, 2018, May 14, 2018, May 19, 2018, May 23, 2018, and May 25, 2018. The Individual/Entity has violated the South Carolina Retail Food Establishment Regulation as follows: failed to maintain proper holding temperatures time/temperature control for safety foods, failed to ensure that a person in charge is certified by a food protection manager certification program that is recognized by the Conference for Food Protection, failed to ensure employees wash hands after engaging in activities that contaminate their hands, failed to ensure that outer openings of the retail food establishment were protected against the entry of insects and rodents by filling or closing the holes and other gaps along floors, walls and ceiling; closed tight-fitting windows; and solid, self-closing doors, and failed to ensure that the plumbing system was installed to preclude backflow of a solid, liquid, or gas contaminant into the water supply system at each point of use at the retail food establishment.

Action: The Individual/Entity is required to: operate and maintain the facility in accordance with the requirements of all applicable regulations, including S.C. Regs. 61-25, and pay a civil penalty in the amount of eleven thousand dollars **(\$11,000.00)**.

191) Order Type and Number: Consent Order 2018-206-03-054  
Order Date: July 20, 2018  
Individual/Entity: **Springdale C**  
Facility: Springdale C  
Location: 1130 Springdale Road  
Rock Hill, SC 29730  
Mailing Address: Same  
County: York  
Previous Orders: 2017-206-03-045 (\$800.00)  
Permit Number: 46-206-03139  
Violations Cited: S.C. Code Ann. Regs. 61-25

Summary: Springdale C (Individual/Entity), located in Rock Hill, South Carolina, is a restaurant. The Department conducted inspections on June 14, 2017, May 8, 2018, and May 17, 2018. The Individual/Entity has violated the South Carolina Retail Food Establishment Regulation as follows: failed to maintain proper cold holding temperatures of time/temperature control for safety foods.

Action: The Individual/Entity is required to: operate and maintain the facility in accordance with the requirements of all applicable regulations, including S.C. Regs. 61-25, and pay a civil penalty in the amount of eight hundred dollars (**\$800.00**).

192) Order Type and Number: Consent Order 2018-206-06-038  
Order Date: July 20, 2018  
Individual/Entity: **Hardees #1500863**  
Facility: Hardees #1500863  
Location: 10 US Highway 17 North  
Surfside Beach, SC 29575  
Mailing Address: 20377 SW Acacia Street, Suite 200  
Newport Beach, CA 92660  
County: Horry  
Previous Orders: 2016-206-06-127 (\$800.00)  
Permit Number: 26-206-13072  
Violations Cited: S.C. Code Ann. Regs. 61-25

Summary: Hardees #1500863 (Individual/Entity), located in Surfside Beach, South Carolina, is a restaurant. The Department conducted inspections on July 11, 2017, January 16, 2018, and April 4, 2018. The Individual/Entity has violated the South Carolina Retail Food Establishment Regulation as follows: failed to ensure written procedures were in place and made available to the Department when the facility uses time as a public health control.

Action: The Individual/Entity is required to: operate and maintain the facility in accordance with the requirements of all applicable regulations, including S.C. Regs. 61-25, and pay a civil penalty in the amount of eight hundred dollars (**\$800.00**).

193) Order Type and Number: Consent Order 2018-206-07-016  
Order Date: July 20, 2018  
Individual/Entity: **Roadside Seafood**  
Facility: Roadside Seafood  
Location: 807 Folly Road  
Charleston, SC 29412  
Mailing Address: Same  
County: Charleston  
Previous Orders: None  
Permit Number: 10-206-08998  
Violations Cited: S.C. Code Ann. Regs. 61-25

Summary: Roadside Seafood (Individual/Entity), located in Charleston, South Carolina, is a restaurant. The Department conducted inspections on June 13, 2017, June 15, 2017, April 20, 2018, and April 30, 2018. The Individual/Entity has violated the South Carolina Retail Food Establishment Regulation as follows: failed to maintain proper holding temperatures of time/temperature control for safety foods.

Action: The Individual/Entity is required to: operate and maintain the facility in accordance with the requirements of all applicable regulations, including S.C. Regs. 61-25, and pay a civil penalty in the amount of one thousand six hundred dollars **(\$1,600.00)**.

194) Order Type and Number: Consent Order 2018-206-07-022  
Order Date: July 24, 2018  
Individual/Entity: **Chinese Express**  
Facility: Chinese Express  
Location: 431-B North Saint James Avenue  
Goose Creek, SC 29445  
Mailing Address: Same  
County: Berkeley  
Previous Orders: None  
Permit Number: 08-206-09175  
Violations Cited: S.C. Code Ann. Regs. 61-25

Summary: Chinese Express (Individual/Entity), located in Goose Creek, South Carolina, is a restaurant. The Department conducted inspections on April 20, 2017, April 3, 2018, and June 7, 2018. The Individual/Entity has violated the South Carolina Retail Food Establishment Regulation as follows: failed to protect food from contamination by storing in a clean, dry location, where it is not exposed to splash, dust, or other contamination, at least 6 inches above the floor.

Action: The Individual/Entity is required to: operate and maintain the facility in accordance with the requirements of all applicable regulations, including S.C. Regs. 61-25, and pay a civil penalty in the amount of two hundred dollars **(\$200.00)**.

195) Order Type and Number: Consent Order 2018-206-07-038  
Order Date: July 24, 2018  
Individual/Entity: **G & C Jayden Inc.**  
Facility: G & C Jayden Inc.  
Location: 1077 King Street  
Charleston, SC 29403  
Mailing Address: Same  
County: Charleston  
Previous Orders: None  
Permit Number: 10-206-09814  
Violations Cited: S.C. Code Ann. Regs. 61-25

Summary: G & C Jayden Inc. (Individual/Entity), located in Charleston, South Carolina, is a restaurant. The Department conducted inspections on September 29, 2016, August 1, 2017, and June 20, 2018. The Individual/Entity has violated the South Carolina Retail Food Establishment Regulation as follows: failed to ensure that when time without temperature control is used as a public health control, the food in unmarked containers or packages shall be discarded.

Action: The Individual/Entity is required to: operate and maintain the facility in accordance with the requirements of all applicable regulations, including S.C. Regs. 61-25, and pay a civil penalty in the amount of eight hundred dollars **(\$800.00)**.

196) Order Type and Number: Consent Order 2018-206-03-066  
Order Date: July 25, 2018  
Individual/Entity: **Ten Ten Restaurant**  
Facility: Ten Ten Restaurant  
Location: 2000 Clemson Road, #1  
Columbia, SC 29223  
Mailing Address: Same  
County: Richland  
Previous Orders: None  
Permit Number: 40-206-07693  
Violations Cited: S.C. Code Ann. Regs. 61-25

Summary: Ten Ten Restaurant (Individual/Entity), located in Columbia, South Carolina, is a restaurant. The Department conducted inspections on July 28, 2016, July 14, 2017, and May 22, 2018. The Individual/Entity has violated the South Carolina Retail Food Establishment Regulation as follows: failed to clearly mark the date by which food shall be consumed on the premises, sold, or discarded when held at a temperature of 41°F or less for a maximum of seven (7) days. This applies only to refrigerated, ready-to-eat, time/temperature control for safety foods prepared and held in a food establishment for more than twenty-four (24) hours. The facility also failed to ensure that when time without temperature control is used as a public health control, the food in unmarked containers or packages shall be discarded.

Action: The Individual/Entity is required to: operate and maintain the facility in accordance with the requirements of all applicable regulations, including S.C. Regs. 61-25, and pay a civil penalty in the amount of four hundred dollars **(\$400.00)**.

197) Order Type and Number: Consent Order 2018-206-03-093  
Order Date: July 25, 2018  
Individual/Entity: **B & T Sub & Salad**  
Facility: B & T Sub & Salad  
Location: 421 Bush River Road, Unit 162  
Columbia, SC 29210  
Mailing Address: 1122 Brookman Road  
Columbia, SC 29210  
County: Richland  
Previous Orders: None  
Permit Number: 40-206-08010  
Violations Cited: S.C. Code Ann. Regs. 61-25

Summary: B & T Sub & Salad (Individual/Entity), located in Columbia, South Carolina, is a restaurant. The Department conducted inspections on August 8, 2017, June 7, 2018, and June 14, 2018. The Individual/Entity has violated the South Carolina Retail Food Establishment Regulation as follows: failed to ensure that all equipment installed in a retail food establishment after the effective date of this regulation shall be certified or classified and listed to National Sanitation Foundation (NSF)/American National Standards Institute (ANSI) Commercial Food Equipment Standards, Baking Industry Sanitation Standards Committee (BISSC) or other accredited ANSI food equipment sanitation certification recognized by the Department.

Action: The Individual/Entity is required to: operate and maintain the facility in accordance with the requirements of all applicable regulations, including S.C. Regs. 61-25, and pay a civil penalty in the amount of two hundred dollars **(\$200.00)**.

198) Order Type and Number: Consent Order 2018-206-05-006  
Order Date: July 25, 2018  
Individual/Entity: **Denmark-Olar Middle School**  
Facility: Denmark-Olar Middle School  
Location: 45 Green Street  
Denmark, SC 29042  
Mailing Address: Same  
County: Bamberg  
Previous Orders: None  
Permit Number: 05-208-00005  
Violations Cited: S.C. Code Ann. Regs. 61-25

Summary: Denmark-Olar Middle School (Individual/Entity), located in Denmark, South Carolina, operates a cafeteria. The Department conducted inspections on May 12, 2017, October 10, 2017, November 6, 2017, April 10, 2018, April 19, 2018, April 30, 2018, and May 24, 2018. The Individual/Entity has violated the South Carolina Retail Food Establishment Regulation as follows: failed to ensure that materials for indoor floor, wall, and ceilings surfaces under conditions of normal use shall be smooth, durable, and easily cleanable for areas where retail food establishment operations are conducted.

Action: The Individual/Entity is required to: operate and maintain the facility in accordance with the requirements of all applicable regulations, including S.C. Regs. 61-25, and pay a civil penalty in the amount of one thousand two hundred fifty dollars (**\$1,250.00**).

199) Order Type and Number: Consent Order 2018-206-01-019  
Order Date: August 1, 2018  
Individual/Entity: **Famous Pizza of Anderson**  
Facility: Famous Pizza of Anderson  
Location: 1417 Pearman Dairy Road  
Anderson, SC 29625  
Mailing Address: Same  
County: Anderson  
Previous Orders: 2017-206-01-020 (\$800.00)  
Permit Number: 04-206-02108  
Violations Cited: S.C. Code Ann. Regs. 61-25

Summary: Famous Pizza of Anderson (Individual/Entity), located in Anderson, South Carolina, is a restaurant. The Department conducted inspections on July 29, 2016, June 20, 2017, and April 25, 2018. The Individual/Entity has violated the South Carolina Retail Food Establishment Regulation as follows: failed to demonstrate knowledge of foodborne disease prevention by having no priority violations during the inspection, failed to maintain the proper sanitization concentration in a chemical sanitizer used in a manual or mechanical operation during contact times, and failed to clearly mark the date by which food shall be consumed on the premises, sold, or discarded when held at a temperature of 41°F or less for a maximum of seven (7) days. This applies only to refrigerated, ready-to-eat, time/temperature control for safety food prepared and held in a food establishment for more than twenty-four (24) hours.

Action: The Individual/Entity is required to: operate and maintain the facility in accordance with the requirements of all applicable regulations, including S.C. Regs. 61-25, and pay a civil penalty in the amount of one thousand dollars (**\$1,000.00**).

200) Order Type and Number: Consent Order 2018-206-01-025  
Order Date: August 1, 2018  
Individual/Entity: **O'Charley's #246**  
Facility: O'Charley's #246  
Location: 3723 Clemson Boulevard  
Anderson, SC 29621  
Mailing Address: 3038 Sidco Drive  
Nashville, TN 37204  
County: Anderson  
Previous Orders: 2015-206-01-040 (\$800.00);  
2016-206-01-037 (\$1,000.00)  
Permit Number: 04-206-02393  
Violations Cited: S.C. Code Ann. Regs. 61-25

Summary: O'Charley's #246 (Individual/Entity), located in Anderson, South Carolina, is a restaurant. The Department conducted inspections on June 19, 2017, January 11, 2018, June 4, 2018, and June 14, 2018. The Individual/Entity has violated the South Carolina Retail Food Establishment Regulation as follows: failed to maintain proper holding temperatures of time/temperature control for safety foods and failed to use effective methods to cool cooked time/temperature control for safety foods.

Action: The Individual/Entity is required to: operate and maintain the facility in accordance with the requirements of all applicable regulations, including S.C. Regs. 61-25, and pay a civil penalty in the amount of three thousand, five hundred dollars (**\$3,500.00**).

201) Order Type and Number: Consent Order 2018-206-03-037  
Order Date: August 1, 2018  
Individual/Entity: **Wal-Mart #5087 Deli/Bakery**  
Facility: Wal-Mart #5087 Deli/Bakery  
Location: 550 North Kings Highway  
North Myrtle Beach, SC 29582  
Mailing Address: 508 SW 8<sup>th</sup> Street  
Bentonville, AR 72716-0500  
County: Horry  
Previous Orders: None  
Permit Number: 26-206-09223  
Violations Cited: S.C. Code Ann. Regs. 61-25

Summary: Wal-Mart #5087 Deli/Bakery (Individual/Entity), located in North Myrtle Beach, South Carolina, is a deli/bakery. The Department conducted inspections on October 31, 2016, August 14, 2017, and April 17, 2018. The Individual/Entity has violated the South Carolina Retail Food Establishment Regulation as follows: failed to ensure written procedures were in place and made available to Department when the facility uses time as a public health control.

Action: The Individual/Entity is required to: operate and maintain the facility in accordance with the requirements of all applicable regulations, including S.C. Regs. 61-25, and pay a civil penalty in the amount of eight hundred dollars (**\$800.00**).



202) Order Type and Number: Consent Order 2018-206-03-051  
Order Date: August 1, 2018  
Individual/Entity: **Lesslie Mart #2**  
Facility: Lesslie Mart #2  
Location: 661 North Anderson Road  
Rock Hill, SC 29730  
Mailing Address: Same  
County: York  
Previous Orders: None  
Permit Number: 46-206-02539  
Violations Cited: S.C. Code Ann. Regs. 61-25

Summary: Lesslie Mart #2 (Individual/Entity), located in Rock Hill, South Carolina, is a convenience store. The Department conducted inspections on May 18, 2017, May 3, 2018, May 9, 2018, and May 11, 2018. The Individual/Entity has violated the South Carolina Retail Food Establishment Regulation as follows: failed to demonstrate knowledge of foodborne disease prevention by having no priority violations during the inspection (PF), failed to maintain proper holding temperatures of time/temperature control for safety foods (P), failed to clean the physical facilities as often as necessary to keep them clean (C), and failed to clearly mark the date by which food shall be consumed on the premises, sold, or discarded when held at temperature of 41°F or less for a maximum of seven (7) days. This applies only to refrigerated, ready-to-eat, time/temperature control for safety foods prepared and held in a food establishment for more than twenty-four (24) hours.

Action: The Individual/Entity is required is required to: operate and maintain the facility in accordance with the requirements of all applicable regulations, including S.C. Regs. 61-25, and pay a civil penalty in the amount of one thousand, eight hundred dollars (**\$1,800.00**).

203) Order Type and Number: Consent Order 2018-206-03-059  
Order Date: August 1, 2018  
Individual/Entity: **Moe's Southwest Grill**  
Facility: Moe's Southwest Grill  
Location: 1910 Cinema Drive, Suite #102  
Rock Hill, SC 29730  
Mailing Address: 9131 Anson Way, Suite #305  
Raleigh, NC 27615  
County: York  
Previous Orders: None  
Permit Number: 46-206-02841  
Violations Cited: S.C. Code Ann. Regs. 61-25

Summary: Moe's Southwest Grill (Individual/Entity), located in Rock Hill, South Carolina, is a restaurant. The Department conducted inspections on June 20, 2017, May 16, 2018, and May 25, 2018. The Individual/Entity has violated the South Carolina Retail Food Establishment Regulation as follows: failed to maintain proper holding temperatures of time/temperature control for safety foods.

Action: The Individual/Entity is required to: operate and maintain the facility in accordance with the requirements of all applicable regulations, including S.C. Regs. 61-25, and pay a civil penalty in the amount of eight hundred dollars (**\$800.00**).

204) Order Type and Number: Consent Order 2018-206-03-071  
Order Date: August 1, 2018  
Individual/Entity: **Miyo's**  
Facility: Miyo's  
Location: 1220 Bower Parkway, Suite E2  
Columbia, SC 29212  
Mailing Address: 209 Wood Moor Place  
Columbia, SC 29212  
County: Lexington  
Previous Orders: None  
Permit Number: 32-206-04057  
Violations Cited: S.C. Code Ann. Regs. 61-25

Summary: Miyo's (Individual/Entity), located in Columbia, South Carolina, is a restaurant. The Department conducted inspections on August 1, 2016, June 27, 2017, and May 31, 2018. The Individual/Entity has violated the South Carolina Retail Food Establishment Regulation as follows: failed to maintain proper holding temperatures of time/temperature control for safety foods.

Action: The Individual/Entity is required to: operate and maintain the facility in accordance with the requirements of all applicable regulations, including S.C. Regs. 61-25, and pay a civil penalty in the amount of eight hundred dollars (**\$800.00**).

205) Order Type and Number: Consent Order 2018-206-03-072  
Order Date: August 1, 2018  
Individual/Entity: **Subway**  
Facility: Subway  
Location: 2002 Bear Village  
Newberry, SC 29108  
Mailing Address: 108 Bronlow Drive  
Irmo, SC 29063  
County: Newberry  
Previous Orders: None  
Permit Number: 36-206-01325  
Violations Cited: S.C. Code Ann. Regs. 61-25

Summary: Subway (Individual/Entity), located in Newberry, South Carolina, is a restaurant. The Department conducted inspections on September 8, 2016, July 24, 2017, May 29, 2018, and June 5, 2018. The Individual/Entity has violated the South Carolina Retail Food Establishment Regulation as follows: failed to maintain proper holding temperatures of time/temperature control for safety foods.

Action: The Individual/Entity is required to: operate and maintain the facility in accordance with the requirements of all applicable regulations, including S.C. Regs. 61-25, and pay a civil penalty in the amount of one thousand, four hundred fifty dollars (**\$1,450.00**).

206) Order Type and Number: Consent Order 2018-206-03-074  
Order Date: August 1, 2018  
Individual/Entity: **Ruby Tuesday #4282**  
Facility: Ruby Tuesday #4282  
Location: 1410 Old Springdale Road  
Rock Hill, SC 29730  
Mailing Address: 333 East Broadway Avenue

County: Maryville, TN 37801  
Previous Orders: York  
Permit Number: None  
Violations Cited: 46-206-01652  
S.C. Code Ann. Regs. 61-25

Summary: Ruby Tuesday #4282 (Individual/Entity), located in Rock Hill, South Carolina, is a restaurant. The Department conducted inspections on April 20, 2017, July 25, 2017, and June 19, 2018. The Individual/Entity has violated the South Carolina Retail Food Establishment Regulation as follows: failed to maintain proper holding temperatures of time/temperature control for safety foods.

Action: The Individual/Entity is required to: operate and maintain the facility in accordance with the requirements of all applicable regulations, including S.C. Regs. 61-25, and pay a civil penalty in the amount of eight hundred dollars (**\$800.00**).

207) Order Type and Number: Consent Order 2018-206-03-090  
Order Date: August 1, 2018  
Individual/Entity: **Ben's Country Store**  
Facility: Ben's Country Store  
Location: 1857 Lincoln Road  
York, SC 29745  
Mailing Address: Same  
County: York  
Previous Orders: None  
Permit Number: 46-206-03411  
Violations Cited: S.C. Code Ann. Regs. 61-25

Summary: Ben's Country Store (Individual/Entity), located in York, South Carolina, is a convenience store. The Department conducted inspections on September 7, 2016, August 31, 2017, and June 21, 2018. The Individual/Entity has violated the South Carolina Retail Food Establishment Regulation as follows: failed to ensure that when time without temperature control is used as a public health control, the food in unmarked containers or packages shall be discarded.

Action: The Individual/Entity is required to: operate and maintain the facility in accordance with the requirements of all applicable regulations, including S.C. Regs. 61-25, and pay a civil penalty in the amount of eight hundred dollars (**\$800.00**).

208) Order Type and Number: Consent Order 2018-206-03-094  
Order Date: August 1, 2018  
Individual/Entity: **Jing Jing Chinese Cuisine**  
Facility: Jing Jing Chinese Cuisine  
Location: 2260 Crosspointe Drive, Suite 99  
Rock Hill, SC 29730  
Mailing Address: Same  
County: York  
Previous Orders: None  
Permit Number: 46-206-01918  
Violations Cited: S.C. Code Ann. Regs. 61-25

Summary: Jing Jing Chinese Cuisine (Individual/Entity), located in Rock Hill, South Carolina, is a restaurant. The Department conducted inspections on October 2, 2017, May 31, 2018, and June 14, 2018.

The Individual/Entity has violated the South Carolina Retail Food Establishment Regulation as follows: failed to maintain proper holding temperatures of time/temperature control for safety foods and failed to ensure that when time without temperature control is used as a public health control, the food in unmarked containers or packages shall be discarded.

Action: The Individual/Entity is required to: operate and maintain the facility in accordance with the requirements of all applicable regulations, including S.C. Regs. 61-25, and pay a civil penalty in the amount of eight hundred dollars (**\$800.00**).

209) <u>Order Type and Number:</u>	Consent Order 2018-206-05-007
<u>Order Date:</u>	August 1, 2018
<u>Individual/Entity:</u>	<b>Hong Kong</b>
<u>Facility:</u>	Hong Kong
<u>Location:</u>	12945 Main Street Williston, SC 29853
<u>Mailing Address:</u>	Same
<u>County:</u>	Barnwell
<u>Previous Orders:</u>	None
<u>Permit Number:</u>	06-206-00505
<u>Violations Cited:</u>	S.C. Code Ann. Regs. 61-25

Summary: Hong Kong (Individual/Entity), located in Williston, South Carolina, is a restaurant. The Department conducted inspections on August 9, 2017, January 25, 2018, May 24, 2018, and May 30, 2018. The Individual/Entity has violated the South Carolina Retail Food Establishment Regulation as follows: failed to ensure that intake and exhaust air ducts shall be cleaned, and filters changed so they are not a source of contamination by dust, dirt, and other materials and if vented to the outside, ventilation systems may not create a public health hazard or nuisance or unlawful discharge.

Action: The Individual/Entity is required to: operate and maintain the facility in accordance with the requirements of all applicable regulations, including S.C. Regs. 61-25, and pay a civil penalty in the amount of four hundred dollars (**\$400.00**).

210) <u>Order Type and Number:</u>	Consent Order 2018-206-05-058
<u>Order Date:</u>	August 1, 2018
<u>Individual/Entity:</u>	<b>New York Diner</b>
<u>Facility:</u>	New York Diner
<u>Location:</u>	920 Inlet Square Drive Murrells Inlet, SC 29576
<u>Mailing Address:</u>	Same
<u>County:</u>	Horry
<u>Previous Orders:</u>	None
<u>Permit Number:</u>	26-206-06878
<u>Violations Cited:</u>	S.C. Code Ann. Regs. 61-25

Summary: New York Diner (Individual/Entity), located in Murrells Inlet, South Carolina, is a restaurant. The Department conducted inspections on May 9, 2017, November 7, 2017, and May 9, 2018. The Individual/Entity has violated the South Carolina Retail Food Establishment Regulation as follows: failed to clearly mark the date by which food shall be consumed on the premises, sold, or discarded when held at a temperature of 41°F or less for a maximum of seven (7) days. This applies only to refrigerated, ready-to-eat, time/temperature control for safety foods prepared and held in a food establishment for more than twenty-four (24) hours.

Action: The Individual/Entity is required is required to: operate and maintain the facility in accordance with the requirements of all applicable regulations, including S.C. Regs. 61-25, and pay a civil penalty in the amount of four hundred dollars **(\$400.00)**.

211) Order Type and Number: Consent Order 2018-206-06-036  
Order Date: August 1, 2018  
Individual/Entity: **Osaka/Top Dining Corp.**  
Facility: Osaka/Top Dining Corp.  
Location: 794 Oak Forest Lane, Suite 101  
Myrtle Beach, SC 29577  
Mailing Address: 644 Kent Lane, Apt. 70A  
Myrtle Beach, SC 29579  
County: Horry  
Previous Orders: None  
Permit Number: 26-206-11665  
Violations Cited: S.C. Code Ann. Regs. 61-25

Summary: Osaka/Top Dining Corp. (Individual/Entity), located in Myrtle Beach, South Carolina, is a restaurant. The Department conducted inspections on September 22, 2017, November 21, 2017, March 22, 2018, and March 28, 2018. The Individual/Entity has violated the South Carolina Retail Food Establishment Regulation as follows: failed to keep food contact surfaces, nonfood contact surfaces, and utensils clean and free of accumulation of dust, dirt, food residue, and other debris and failed to ensure that when time without temperature control is used as a public health control, the food in unmarked containers or packages shall be discarded.

Action: The Individual/Entity is required to: operate and maintain the facility in accordance with the requirements of all applicable regulations, including S.C. Regs. 61-25, and pay a civil penalty in the amount of eight hundred dollars **(\$800.00)**.

212) Order Type and Number: Consent Order 2018-206-06-048  
Order Date: August 1, 2018  
Individual/Entity: **Tia's Caribbean Taste**  
Facility: Tia's Caribbean Taste  
Location: 4914 Broad Street  
Loris, SC 29569  
Mailing Address: Same  
County: Horry  
Previous Orders: None  
Permit Number: 26-206-13676  
Violations Cited: S.C. Code Ann. Regs. 61-25

Summary: Tia's Caribbean Taste (Individual/Entity), located in Loris, South Carolina, is a restaurant. The Department conducted inspections on May 1, 2018, May 7, 2018, and May 17, 2018. The Individual/Entity has violated the South Carolina Retail Food Establishment Regulation as follows: failed to maintain proper holding temperatures of time/temperature control for safety foods.

Action: The Individual/Entity is required to: operate and maintain the facility in accordance with the requirements of all applicable regulations, including S.C. Regs. 61-25, and pay a civil penalty in the amount of eight hundred dollars **(\$800.00)**.

213) Order Type and Number: Consent Order 2018-206-06-065  
Order Date: August 1, 2018  
Individual/Entity: **Myrtle Beach Marriott Resort**  
Facility: Myrtle Beach Marriott Resort  
Location: 8400 Costa Verde Drive  
Myrtle Beach, SC 29572  
Mailing Address: 740 Centre View Boulevard  
Fort Mitchell, KY 41017  
County: Horry  
Previous Orders: None  
Permit Number: 26-206-09211  
Violations Cited: S.C. Code Ann. Regs. 61-25

Summary: Myrtle Beach Marriott Resort (Individual/Entity), located in Myrtle Beach, South Carolina, is a restaurant. The Department conducted inspections on November 7, 2017, November 17, 2017, June 4, 2018, and June 13, 2018. The Individual/Entity has violated the South Carolina Retail Food Establishment Regulation as follows: failed to maintain proper holding temperatures of time/temperature control for safety foods.

Action: The Individual/Entity is required to: operate and maintain the facility in accordance with the requirements of all applicable regulations, including S.C. Regs. 61-25, and pay a civil penalty in the amount of one thousand six hundred dollars **(\$1,600.00)**.

214) Order Type and Number: Consent Order 2018-206-06-076  
Order Date: August 1, 2018  
Individual/Entity: **Thai Cuisine**  
Facility: Thai Cuisine  
Location: 1208 North Kings Highway  
Myrtle Beach, SC 29577  
Mailing Address: Same  
County: Horry  
Previous Orders: 2017-206-06-120 (\$1,600.00);  
2018-206-06-005 (\$1,000.00)  
Permit Number: 26-206-11999  
Violations Cited: S.C. Code Ann. Regs. 61-25

Summary: Thai Cuisine (Individual/Entity), located in Myrtle Beach, South Carolina, is a restaurant. The Department conducted inspections on June 7, 2018, and June 12, 2018. The Individual/Entity has violated the South Carolina Retail Food Establishment Regulation as follows: failed to maintain proper holding temperatures of time/temperature control for safety foods.

Action: The Individual/Entity is required to: operate and maintain the facility in accordance with the requirements of all applicable regulations, including S.C. Regs. 61-25, and pay a civil penalty in the amount of two thousand dollars **(\$2,000.00)**.

215) Order Type and Number: Consent Order 2018-206-06-077  
Order Date: August 1, 2018  
Individual/Entity: **New Tai Chang**  
Facility: New Tai Chang  
Location: 28 East Main Street  
Andrews, SC 29510

Mailing Address: Same  
County: Georgetown  
Previous Orders: 2016-206-06-060 (\$800.00);  
2017-206-06-068 (\$1,750.00)  
Permit Number: 22-206-06224  
Violations Cited: S.C. Code Ann. Regs. 61-25

Summary: New Tai Chang (Individual/Entity), located in Andrews, South Carolina, is a restaurant. The Department conducted inspections on February 13, 2017, February 21, 2017, February 2, 2018, and June 11, 2018. The Individual/Entity has violated the South Carolina Retail Food Establishment Regulation as follows: failed to provide a written plan for the restriction, exclusion, and re-instatement of employees when they have symptoms and/or diseases that are transmissible through food and failed to clearly mark the date by which food shall be consumed on the premises, sold, or discarded when held at temperature of 41°F or less for a maximum of seven (7) days. This applies only to refrigerated, ready-to-eat, time/temperature control for safety foods prepared and held in a food establishment for more than twenty-four (24) hours.

Action: The Individual/Entity is required to: operate and maintain the facility in accordance with the requirements of all applicable regulations, including S.C. Regs. 61-25, and pay a civil penalty in the amount of eight hundred dollars **(\$800.00)**.

216) Order Type and Number: Consent Order 2018-206-07-027  
Order Date: August 1, 2018  
Individual/Entity: **RB's Seafood Restaurant**  
Facility: RB's Seafood Restaurant  
Location: 97 Church Street  
Mount Pleasant, SC 29464  
Mailing Address: Same  
County: Charleston  
Previous Orders: 2015-206-07-078 (\$800.00);  
2017-206-07-010 (\$800.00)  
Permit Number: 10-206-04737  
Violations Cited: S.C. Code Ann. Regs. 61-25

Summary: RB's Seafood Restaurant (Individual/Entity), located in Mount Pleasant, South Carolina is a restaurant. The Department conducted inspections on May 23, 2017, May 22, 2018, and June 4, 2018. The Individual/Entity has violated the South Carolina Retail Food Establishment Regulation as follows: failed to properly cool cooked time/temperature control for safety foods, failed to use effective methods to cool cooked time/temperature control for safety foods, and failed to keep shellstock tags or labels attached to the container in which the shellstock are received until the container is empty.

Action: The Individual/Entity is required to: operate and maintain the facility in accordance with the requirements of all applicable regulations, including S.C. Regs. 61-25, and pay a civil penalty in the amount of two thousand dollars **(\$2,000.00)**.

217) Order Type and Number: Consent Order 2018-206-07-031  
Order Date: August 1, 2018  
Individual/Entity: **Rutledge Cab Co.**  
Facility: Rutledge Cab Co.  
Location: 1300 Rutledge Avenue  
Charleston, SC 29403

Mailing Address: Same  
County: Charleston  
Previous Orders: None  
Permit Number: 10-206-08611  
Violations Cited: S.C. Code Ann. Regs. 61-25

Summary: Rutledge Cab Co. (Individual/Entity), located in Charleston, South Carolina, is a restaurant. The Department conducted inspections on June 21, 2017, June 19, 2018, and June 20, 2018. The Individual/Entity has violated the South Carolina Retail Food Establishment Regulation as follows: failed to maintain proper holding temperatures of time/temperature control for safety foods.

Action: The Individual/Entity is required to: operate and maintain the facility in accordance with the requirements of all applicable regulations, including S.C. Regs. 61-25, and pay a civil penalty in the amount of eight hundred dollars (**\$800.00**).

218) Order Type and Number: Consent Order 2018-206-07-033  
Order Date: August 1, 2018  
Individual/Entity: **Tasty Thai and Sushi**  
Facility: Tasty Thai and Sushi  
Location: 350 King Street  
Charleston, SC 29401  
Mailing Address: Same  
County: Charleston  
Previous Orders: 2015-206-07-081 (\$800.00);  
2017-206-07-028 (\$800.00)  
Permit Number: 10-206-07255  
Violations Cited: S.C. Code Ann. Regs. 61-25

Summary: Tasty Thai and Sushi (Individual/Entity), located in Charleston, South Carolina, is a restaurant. The Department conducted an inspection on June 14, 2018. The Individual/Entity has violated the South Carolina Retail Food Establishment Regulation as follows: failed to maintain proper holding temperatures of time/temperature control for safety foods.

Action: The Individual/Entity is required to: operate and maintain the facility in accordance with the requirements of all applicable regulations, including S.C. Regs. 61-25, and pay a civil penalty in the amount of one thousand dollars (**\$1,000.00**).

219) Order Type and Number: Consent Order 2018-206-07-041  
Order Date: August 1, 2018  
Individual/Entity: **Golden House**  
Facility: Golden House  
Location: 111 Foxbank Plantation Boulevard  
Moncks Corner, SC 29461  
Mailing Address: Same  
County: Berkeley  
Previous Orders: None  
Permit Number: 08-206-10786  
Violations Cited: S.C. Code Ann. Regs. 61-25

Summary: Golden House (Individual/Entity), located in Moncks Corner, South Carolina, is a restaurant. The Department conducted inspections on August 31, 2017, June 28, 2018, and July 10, 2018.



The Individual/Entity has violated the South Carolina Retail Food Establishment Regulation as follows: failed to protect food from contamination by storing in a clean, dry location, where it is not exposed to splash, dust, or other contamination, at least 6 inches above the floor.

Action: The Individual/Entity is required to: operate and maintain the facility in accordance with the requirements of all applicable regulations, including S.C. Regs. 61-25, and pay a civil penalty in the amount of two hundred dollars **(\$200.00)**.

220) Order Type and Number: Consent Order 2018-206-06-078  
Order Date: August 2, 2018  
Individual/Entity: **Starbucks Coffee #18021**  
Facility: Starbucks Coffee #18021  
Location: 102 Loyola Drive  
Myrtle Beach, SC 29575  
Mailing Address: P.O. Box 34442 S-TAX2  
Seattle, WA 98124-1442  
County: Horry  
Previous Orders: None  
Permit Number: 26-206-12233  
Violations Cited: S.C. Code Ann. Regs. 61-25

Summary: Starbucks Coffee #18021 (Individual/Entity), located in Myrtle Beach, South Carolina, is a restaurant. The Department conducted inspections on March 30, 2017, July 5, 2017, and June 8, 2018. The Individual/Entity has violated the South Carolina Retail Food Establishment Regulation as follows: failed to provide an irreversible registering temperature indicator for measuring the utensil surface temperature in hot water mechanical warewashing operations.

Action: The Individual/Entity is required is required to: operate and maintain the facility in accordance with the requirements of all applicable regulations, including S.C. Regs. 61-25, and pay a civil penalty in the amount of two hundred dollars **(\$200.00)**.

221) Order Type and Number: Consent Order 2018-206-01-027  
Order Date: August 3, 2018  
Individual/Entity: **Rainbow Garden**  
Facility: Rainbow Garden  
Location: 1085 Old Clemson Highway  
Seneca, SC 29672  
Mailing Address: Same  
County: Oconee  
Previous Orders: 2015-206-01-048 (\$100.00)  
Permit Number: 37-206-00925  
Violations Cited: S.C. Code Ann. Regs. 61-25

Summary: Rainbow Garden (Individual/Entity), located in Seneca, South Carolina, is a restaurant. The Department conducted inspections on July 28, 2016, July 27, 2017 and June 12, 2018. The Individual/Entity has violated the South Carolina Retail Food Establishment Regulation as follows: failed to clean non-food contact surfaces at a frequency to preclude accumulation of soil residues.

Action: The Individual/Entity is required is required to: operate and maintain the facility in accordance with the requirements of all applicable regulations, including S.C. Regs. 61-25, and pay a civil penalty in the amount of two hundred dollars **(\$200.00)**.

222) Order Type and Number: Consent Order 2018-206-02-036  
Order Date: August 3, 2018  
Individual/Entity: **Caviar & Bananas**  
Facility: Caviar & Bananas  
Location: 1 North Laurens Street, Suite A  
Greenville, SC 29601  
Mailing Address: P.O. Box 21969  
Charleston, SC 29413  
County: Greenville  
Previous Orders: None  
Permit Number: 23-206-11456  
Violations Cited: S.C. Code Ann. Regs. 61-25

Summary: Caviar & Bananas (Individual/Entity), located in Greenville, South Carolina, is a restaurant. The Department conducted inspections on December 6, 2016, September 5, 2017, and May 2018. The Individual/Entity has violated the South Carolina Retail Food Establishment Regulation as follows: failed to ensure that when time without temperature control is used as a public health control, the food in unmarked containers or packages shall be discarded.

Action: The Individual/Entity is required to: operate and maintain the facility in accordance with the requirements of all applicable regulations, including S.C. Regs. 61-25, and pay a civil penalty in the amount of eight hundred dollars **(\$800.00)**.

223) Order Type and Number: Consent Order 2018-206-06-039  
Order Date: August 3, 2018  
Individual/Entity: **Dunkin Donuts**  
Facility: Dunkin Donuts  
Location: 593 Highway 90  
Little River, SC 29566  
Mailing Address: Same  
County: Horry  
Previous Orders: None  
Permit Number: 26-206-11032  
Violations Cited: S.C. Code Ann. Regs. 61-25

Summary: Dunkin Donuts (Individual/Entity), located in Little River, South Carolina, is a restaurant. The Department conducted inspections on July 19, 2017, July 28, 2017, and April 3, 2018. The Individual/Entity has violated the South Carolina Retail Food Establishment Regulation as follows: failed to maintain proper holding temperatures of time/temperature control for safety foods.

Action: The Individual/Entity is required to: operate and maintain the facility in accordance with the requirements of all applicable regulations, including S.C. Regs. 61-25, and pay a civil penalty in the amount of five hundred fifty dollars **(\$550.00)**.

224) Order Type and Number: Consent Order 2018-206-06-075  
Order Date: August 3, 2018  
Individual/Entity: **Wok on the Beach**  
Facility: Wok on the Beach  
Location: 6001 North Kings Highway  
Myrtle Beach, SC 29577  
Mailing Address: Same

County: Horry  
Previous Orders: 2018-206-06-016 (\$800.00)  
Permit Number: 26-206-13342  
Violations Cited: S.C. Code Ann. Regs. 61-25

Summary: Wok on the Beach (Individual/Entity), located in Myrtle Beach, South Carolina, is a restaurant. The Department conducted an inspection on June 13, 2018. The Individual/Entity has violated the South Carolina Retail Food Establishment Regulation as follows: failed to maintain proper hot holding temperatures of time/temperature control for safety foods.

Action: The Individual/Entity is required to: operate and maintain the facility in accordance with the requirements of all applicable regulations, including S.C. Regs. 61-25, and pay a civil penalty in the amount of one thousand dollars **(\$1,000.00)**.

225) Order Type and Number: Consent Order 2018-206-01-026  
Order Date: August 6, 2018  
Individual/Entity: **Taqueria Mi Taco**  
Facility: Taqueria Mi Taco  
Location: 5928 Highway 187  
Anderson, SC 29625  
Mailing Address: Same  
County: Anderson  
Previous Orders: None  
Permit Number: 04-206-04351  
Violations Cited: S.C. Code Ann. Regs. 61-25

Summary: Taqueria Mi Taco (Individual/Entity), located in Anderson, South Carolina, is a restaurant. The Department conducted inspections on January 27, 2017, January 16, 2018, May 31, 2018, June 7, 2018, and June 15, 2018. The Individual/Entity has violated the South Carolina Retail Food Establishment Regulation as follows: failed to provide water at a temperature of at least 100°F through a mixing valve or combination faucet at the handwashing sink(s) and failed to clearly mark the date by which food shall be consumed on the premises, sold, or discarded when held at a temperature of 41°F or less for a maximum of seven (7) days. This applies only to refrigerated, ready-to-eat, time/temperature control for safety foods prepared and held in a food establishment for more than twenty-four (24) hours.

Action: The Individual/Entity is required to: operate and maintain the facility in accordance with the requirements of all applicable regulations, including S.C. Regs. 61-25, and pay a civil penalty in the amount of eight hundred dollars **(\$800.00)**.

226) Order Type and Number: Consent Order 2018-206-06-060  
Order Date: August 6, 2018  
Individual/Entity: **King Po Chinese Restaurant**  
Facility: King Po Chinese Restaurant  
Location: 250 East Main Street  
Kingstree, SC 29556  
Mailing Address: Same  
County: Williamsburg  
Previous Orders: 2016-206-06-080 (\$550.00);  
2018-206-06-035 (\$2,000.00)  
Permit Number: 45-206-00181  
Violations Cited: S.C. Code Ann. Regs. 61-25

Summary: King Po Chinese Restaurant (Individual/Entity), located in Kingstree, South Carolina, is a restaurant. The Department conducted inspections on March 24, 2017, February 28, 2018, and May 30, 2018. The Individual/Entity has violated the South Carolina Retail Food Establishment Regulation as follows: failed to clearly mark the date by which food shall be consumed on the premises, sold, or discarded when held at a temperature of 41°F or less for a maximum of seven (7) days. This applies only to refrigerated, ready-to-eat, time/temperature control for safety foods prepared and held in a food establishment for more than twenty-four (24) hours.

Action: The Individual/Entity is required to: operate and maintain the facility in accordance with the requirements of all applicable regulations, including S.C. Regs. 61-25, and pay a civil penalty in the amount of four hundred dollars **(\$400.00)**.

227) Order Type and Number: Consent Order 2018-206-03-061  
Order Date: August 7, 2018  
Individual/Entity: **Waffle House #1198**  
Facility: Waffle House #1198  
Location: 7813 Broad River Road  
Irmo, SC 29063  
Mailing Address: P.O. Box 6450  
Norcross, GA 30091  
County: Richland  
Previous Orders: None  
Permit Number: 40-206-04156  
Violations Cited: S.C. Code Ann. Regs. 61-25

Summary: Waffle House #1198 (Individual/Entity), located in Irmo, South Carolina, is a restaurant. The Department conducted inspections on August 11, 2016, June 26, 2017, and May 17, 2018. The Individual/Entity has violated the South Carolina Retail Food Establishment Regulation as follows: failed to maintain proper holding temperatures of time/temperature control for safety foods.

Action: The Individual/Entity is required to: operate and maintain the facility in accordance with the requirements of all applicable regulations, including S.C. Regs. 61-25, and pay a civil penalty in the amount of five hundred fifty dollars **(\$550.00)**.

228) Order Type and Number: Consent Order 2018-206-03-062  
Order Date: August 7, 2018  
Individual/Entity: **Waffle House #939**  
Facility: Waffle House #939  
Location: 8600 Farrow Road  
Columbia, SC 2923  
Mailing Address: P.O. Box 6450  
Norcross, GA 30091  
County: Richland  
Previous Orders: 2015-206-03-069 (\$800.00)  
Permit Number: 40-206-03351  
Violations Cited: S.C. Code Ann. Regs. 61-25

Summary: Waffle House #939 (Individual/Entity), located in Columbia, South Carolina, is a restaurant. The Department conducted inspections on June 8, 2017, May 14, 2018, and May 25, 2018. The Individual/Entity has violated the South Carolina Retail Food Establishment Regulation as follows: failed to maintain proper holding temperatures of time/temperature control for safety foods.

Action: The Individual/Entity is required to: operate and maintain the facility in accordance with the requirements of all applicable regulations, including S.C. Regs. 61-25, and pay a civil penalty in the amount of eight hundred dollars **(\$800.00)**.

229) Order Type and Number: Consent Order 2018-206-03-067  
Order Date: August 7, 2018  
Individual/Entity: **Pizzeria Opa**  
Facility: Pizzeria Opa  
Location: 7320 Broad River Road  
Irmo, SC 29063  
Mailing Address: Same  
County: Richland  
Previous Orders: None  
Permit Number: 40-206-05645  
Violations Cited: S.C. Code Ann. Regs. 61-25

Summary: Pizzeria Opa (Individual/Entity), located in Irmo, South Carolina, is a restaurant. The Department conducted inspections on July 1, 2016, June 5, 2017, and May 17, 2018. The Individual/Entity has violated the South Carolina Retail Food Establishment Regulation as follows: failed to protect food from contamination by storing in a clean, dry location, where it is not exposed to splash, dust, or other contamination, at least 6 inches above the floor.

Action: The Individual/Entity is required to: operate and maintain the facility in accordance with the requirements of all applicable regulations, including S.C. Regs. 61-25, and pay a civil penalty in the amount of two hundred dollars **(\$200.00)**.

230) Order Type and Number: Consent Order 2018-206-03-073  
Order Date: August 7, 2018  
Individual/Entity: **Liberty Taproom and Grill**  
Facility: Liberty Taproom and Grill  
Location: 828 Gervais Street  
Columbia, SC 29201  
Mailing Address: Same  
County: Richland  
Previous Orders: None  
Permit Number: 40-206-05164  
Violations Cited: S.C. Code Ann. Regs. 61-25

Summary: Liberty Taproom and Grill (Individual/Entity), located in Columbia, South Carolina, is a restaurant. The Department conducted inspections on August 31, 2016, July 21, 2017, and June 11, 2018. The Individual/Entity has violated the South Carolina Retail Food Establishment Regulation as follows: failed to maintain proper holding temperatures of time/temperature control for safety foods.

Action: The Individual/Entity is required to: operate and maintain the facility in accordance with the requirements of all applicable regulations, including S.C. Regs. 61-25, and pay a civil penalty in the amount of five hundred fifty dollars **(\$550.00)**.

231) Order Type and Number: Consent Order 2018-206-03-078  
Order Date: August 7, 2018  
Individual/Entity: **Harris Teeter #82 Deli**  
Facility: Harris Teeter #82 Deli  
Location: 1750 Highway 160 West  
Fort Mill, SC 29708  
Mailing Address: P.O. Box 10100  
Matthews, NC 28106  
County: York  
Previous Orders: None  
Permit Number: 46-206-00524  
Violations Cited: S.C. Code Ann. Regs. 61-25

Summary: Harris Teeter #82 Deli (Individual/Entity), located in Fort Mill, South Carolina, is a deli. The Department conducted inspections on August 23, 2016, August 17, 2017, and June 15, 2018. The Individual/Entity has violated the South Carolina Retail Food Establishment Regulation as follows: failed to maintain proper holding temperatures of time/temperature control for safety foods.

Action: The Individual/Entity is required to: operate and maintain the facility in accordance with the requirements of all applicable regulations, including S.C. Regs. 61-25, and pay a civil penalty in the amount of eight hundred dollars (**\$800.00**).

232) Order Type and Number: Consent Order 2018-206-03-098  
Order Date: August 7, 2018  
Individual/Entity: **M Kitchen**  
Facility: M Kitchen  
Location: 340 Columbiana Drive  
Columbia, SC 29212  
Mailing Address: 209 Wood Moor Place  
Columbia, SC 29212  
County: Richland  
Previous Orders: None  
Permit Number: 40-206-07597  
Violations Cited: S.C. Code Ann. Regs. 61-25

Summary: M Kitchen (Individual/Entity), located in Columbia, South Carolina, is a restaurant. The Department conducted inspections on June 8, 2017, July 19, 2017, and July 2, 2018. The Individual/Entity has violated the South Carolina Retail Food Establishment Regulation as follows: failed to maintain proper holding temperatures of time/temperature control for safety foods.

Action: The Individual/Entity is required to: operate and maintain the facility in accordance with the requirements of all applicable regulations, including S.C. Regs. 61-25, and pay a civil penalty in the amount of eight hundred dollars (**\$800.00**).

233) Order Type and Number: Consent Order 2018-206-06-062  
Order Date: August 7, 2018  
Individual/Entity: **Moose Lodge #2351**  
Facility: Moose Lodge #2351  
Location: 9763 Moose Road  
Murrells Inlet, SC 29576  
Mailing Address: P.O. Box 14947

County: Surfside Beach, SC 29587  
Previous Orders: Horry  
Permit Number: None  
Violations Cited: 26-206-07212  
S.C. Code Ann. Regs. 61-25

Summary: Moose Lodge #2351 (Individual/Entity), located in Murrells Inlet, South Carolina, operates a restaurant. The Department conducted inspections on April 6, 2017, October 10, 2017, and March 1, 2018. The Individual/Entity has violated the South Carolina Retail Food Establishment Regulation as follows: failed to clearly mark the date by which food shall be consumed on the premises, sold, or discarded when held at a temperature of 41°F or less for a maximum of seven (7) days. This applies only to refrigerated, ready-to-eat, time/temperature control for safety foods prepared and held in a food establishment for more than twenty-four (24) hours.

Action: The Individual/Entity is required to: operate and maintain the facility in accordance with the requirements of all applicable regulations, including S.C. Regs. 61-25, and pay a civil penalty in the amount of four hundred dollars (**\$400.00**).

234) Order Type and Number: Consent Order 2018-206-06-063  
Order Date: August 7, 2018  
Individual/Entity: **Sandtrap**  
Facility: Sandtrap  
Location: 2701 South Ocean Boulevard  
North Myrtle Beach, SC 29582  
Mailing Address: Same  
County: Horry  
Previous Orders: None  
Permit Number: 26-206-08452  
Violations Cited: S.C. Code Ann. Regs. 61-25

Summary: Sandtrap (Individual/Entity), located in North Myrtle Beach, South Carolina, is a restaurant. The Department conducted inspections on April 20, 2017, September 1, 2017, September 12, 2017, April 26, 2018, May 4, 2018, and May 14, 2018. The Individual/Entity has violated the South Carolina Retail Food Establishment Regulation as follows: failed to maintain proper holding temperatures, failed to maintain time/temperature control for safety foods, failed to keep food contact surfaces, nonfood contact surfaces, and utensils clean and free of accumulation of dust, dirt, food residue and other debris, and failed to clean the physical facilities as often as necessary to keep them clean.

Action: The Individual/Entity is required to: operate and maintain the facility in accordance with the requirements of all applicable regulations, including S.C. Regs. 61-25, and pay a civil penalty in the amount of four thousand dollars (**\$4,000.00**).

235) Order Type and Number: Consent Order 2018-206-07-037  
Order Date: August 7, 2018  
Individual/Entity: **Adriana Garcia Lopez**  
Facility: Adriana Garcia Lopez  
Location: 1147 College Park Road, Lot 14  
Summerville, SC 29483  
Mailing Address: Same  
County: Berkeley  
Previous Orders: None

Permit Number: N/A  
Violations Cited: S.C. Code Ann. Regs. 61-25

Summary: Adriana Garcia Lopez (Individual/Entity), located in Summerville, South Carolina operates a retail food establishment. The Department conducted complaint investigations on December 2017, and June 29, 2018. The Individual/Entity has violated the South Carolina Retail Food Establishment Regulation as follows: providing food to the public without a valid permit issued by the Department.

Action: The Individual/Entity is required to: operate and maintain the facility in accordance with the requirements of all applicable regulations, including S.C. Regs. 61-25, and pay a civil penalty in the amount of one thousand, six hundred dollars **(\$1,600.00)**.

236) Order Type and Number: Consent Order 2018-206-07-040  
Order Date: August 7, 2018  
Individual/Entity: **McDonald's #16450**  
Facility: McDonald's #16450  
Location: 7400 Rivers Avenue  
North Charleston, SC 29406  
Mailing Address: 8584 Rivers Avenue, Suite 103  
North Charleston, SC 29406  
County: Charleston  
Previous Orders: None  
Permit Number: 10-206-07306  
Violations Cited: S.C. Code Ann. Regs. 61-25

Summary: McDonald's#16450 (Individual/Entity), located in North Charleston, South Carolina, is a restaurant. The Department conducted inspections on March 1, 2017, November 2, 2017, November 8, 2017, November 17, 2017, June 19, 2018, and June 29, 2018. The Individual/Entity has violated the South Carolina Retail Food Establishment Regulation as follows: failed to maintain the premises free of insects, rodents, and other pests.

Action: The Individual/Entity is required to: operate and maintain the facility in accordance with the requirements of all applicable regulations, including S.C. Regs. 61-25, and pay a civil penalty in the amount of one thousand, six hundred dollars **(\$1,600.00)**.

237) Order Type and Number: Consent Order 2018-204-03-003  
Order Date: August 8, 2018  
Individual/Entity: **Mizter Browns Foods**  
Facility: Mizter Browns Foods  
Location: 6169 St. Andrews Road  
Columbia, SC 29212  
Mailing Address: 6 Tip Top Court  
Irmo, SC 29063  
County: Lexington  
Previous Orders: None  
Permit Number: 32-204-06672  
Violations Cited: S.C. Code Ann. Regs. 61-25

Summary: Mizter Browns Foods (Individual/Entity), located in Columbia, South Carolina, is a mobile food unit. The Department conducted inspections on July 8, 2017, July 19, 2017, April 25, 2018, May 2, 2018, and May 16, 2018. The Individual/Entity has violated the South Carolina Retail Food



Establishment Regulation as follows: failed to maintain proper holding temperatures of time/temperature control for safety foods.

Action: The Individual/Entity is required to: operate and maintain the facility in accordance with the requirements of all applicable regulations, including S.C. Regs. 61-25, and pay a civil penalty in the amount of two thousand, four hundred dollars **(\$2,400.00)**.

238) Order Type and Number: Consent Order 2018-206-02-030  
Order Date: August 9, 2018  
Individual/Entity: **Moe's Southwest Grill**  
Facility: Moe's Southwest Grill  
Location: 391 College Avenue, Suite 101  
Clemson, SC 29631  
Mailing Address: 201 West Stone Avenue  
Greenville, SC 29604  
County: Pickens  
Previous Orders: None  
Permit Number: 39-206-01336  
Violations Cited: S.C. Code Ann. Regs. 61-25

Summary: Moe's Southwest Grill (Individual/Entity), located in Clemson, South Carolina, is a restaurant. The Department conducted inspections on April 26, 2017, March 14, 2018, and April 24, 2018. The Individual/Entity has violated the South Carolina Retail Food Establishment Regulation as follows: failed to properly cool cooked time/temperature control for safety foods.

Action: The Individual/Entity is required to: operate and maintain the facility in accordance with the requirements of all applicable regulations, including S.C. Regs. 61-25, and pay a civil penalty in the amount of eight hundred dollars **(\$800.00)**.

239) Order Type and Number: Consent Order 2018-206-02-038  
Order Date: August 9, 2018  
Individual/Entity: **OJ's Diner**  
Facility: OJ's Diner  
Location: 907 Pendleton Street  
Greenville, SC 29601  
Mailing Address: Same  
County: Greenville  
Previous Orders: 2016-206-02-023 (\$800.00);  
2018-206-02-002 (\$800.00)  
Permit Number: 23-206-08630  
Violations Cited: S.C. Code Ann. Regs. 61-25

Summary: OJ's Diner (Individual/Entity), located in Greenville, South Carolina, is a restaurant. The Department conducted inspections on January 31, 2017, September 13, 2017, and June 25, 2018. The Individual/Entity has violated the South Carolina Retail Food Establishment Regulation as follows: failed to ensure that when time without temperature control is used as a public health control, the food in unmarked containers or packages shall be discarded.

Action: The Individual/Entity is required to: operate and maintain the facility in accordance with the requirements of all applicable regulations, including S.C. Regs. 61-25, and pay a civil penalty in the amount of eight hundred dollars **(\$800.00)**.

240) Order Type and Number: Consent Order 2018-206-03-070  
Order Date: August 9, 2018  
Individual/Entity: **British Bulldog**  
Facility: British Bulldog  
Location: 1220 Bower Parkway, Suite E10  
Columbia, SC 29212  
Mailing Address: Same  
County: Lexington  
Previous Orders: None  
Permit Number: 32-206-05808  
Violations Cited: S.C. Code Ann. Regs. 61-25

Summary: British Bulldog (Individual/Entity), located in Columbia, South Carolina, is a restaurant. The Department conducted inspections on July 8, 2016, June 19, 2017, and May 29, 2018. The Individual/Entity has violated the South Carolina Retail Food Establishment Regulation as follows: failed to maintain proper holding temperatures of time/temperature control for safety foods.

Action: The Individual/Entity is required to: operate and maintain the facility in accordance with the requirements of all applicable regulations, including S.C. Regs. 61-25, and pay a civil penalty in the amount of five hundred fifty dollars (**\$550.00**).

241) Order Type and Number: Consent Order 2018-206-03-084  
Order Date: August 9, 2018  
Individual/Entity: **Circle K #8401**  
Facility: Circle K #8401  
Location: 1830 Celanese Road  
Rock Hill, SC 29730  
Mailing Address: 2550 West Tyvola Road, Suite 200  
Charlotte, NC 28217  
County: York  
Previous Orders: None  
Permit Number: 46-206-00639  
Violations Cited: S.C. Code Ann. Regs. 61-25

Summary: Circle K #8401 (Individual/Entity), located in Rock Hill, South Carolina, is a convenience store. The Department conducted inspections on November 23, 2016, August 9, 2017, June 7, 2018, and June 14, 2018. The Individual/Entity has violated the South Carolina Retail Food Establishment Regulation as follows: failed to ensure that when time without temperature control is used as a public health control the food in unmarked containers or packages shall be discarded, failed to ensure that the handwashing sinks were accessible at all times, failed to clean the physical facilities as often as necessary to keep them clean, and failed to maintain the premises free of insects, rodents, and other pests.

Action: The Individual/Entity is required to: operate and maintain the facility in accordance with the requirements of all applicable regulations, including S.C. Regs. 61-25, and pay a civil penalty in the amount of one thousand, four hundred dollars (**\$1,400.00**).

242) Order Type and Number: Consent Order 2018-206-03-087  
Order Date: August 9, 2018  
Individual/Entity: **Fatz Café #20**  
Facility: Fatz Café #20  
Location: 7420 Broad River Road

Mailing Address: Irmo, SC 29063  
4324 Wade Hampton Boulevard, Suite B  
Taylors, SC 29687  
County: Richland  
Previous Orders: 2017-206-03-044 (\$800.00)  
Permit Number: 40-206-04993  
Violations Cited: S.C. Code Ann. Regs. 61-25

Summary: Fatz Café #20 (Individual/Entity), located in Irmo, South Carolina, is a restaurant. The Department conducted inspections on February 27, 2017, July 14, 2017, and June 4, 2018. The Individual/Entity has violated the South Carolina Retail Food Establishment Regulation as follows: failed to maintain proper holding temperatures of time/temperature control for safety foods and failed to properly cool cooked time/temperature control for safety foods.

Action: The Individual/Entity is required is required to: operate and maintain the facility in accordance with the requirements of all applicable regulations, including S.C. Regs. 61-25, and pay a civil penalty in the amount of one thousand dollars (**\$1,000.00**).

243) Order Type and Number: Consent Order 2018-206-06-059  
Order Date: August 9, 2018  
Individual/Entity: **Carver's Bay Convenience Store**  
Facility: Carver's Bay Convenience Store  
Location: 13017 Choppee Road  
Hemingway, SC 29554  
Mailing Address: Same  
County: Georgetown  
Previous Orders: None  
Permit Number: 22-206-06242  
Violations Cited: S.C. Code Ann. Regs. 61-25

Summary: Carver's Bay Convenience Store (Individual/Entity), located in Hemingway, South Carolina, is a convenience store. The Department conducted inspections on April 10, 2017, November 9, 2017, and May 31, 2018. The Individual/Entity has violated the South Carolina Retail Food Establishment Regulation as follows: failed to clearly mark the date by which food shall be consumed on the premises, sold, or discarded when held at a temperature of 41°F or less for a maximum of seven (7) days. This applies only to refrigerated, ready-to-eat, time/temperature control for safety foods prepared and held in a food establishment for more than twenty-four (24) hours.

Action: The Individual/Entity is required is required to: operate and maintain the facility in accordance with the requirements of all applicable regulations, including S.C. Regs. 61-25, and pay a civil penalty in the amount of four hundred dollars (**\$400.00**).

244) Order Type and Number: Consent Order 2018-206-06-071  
Order Date: August 9, 2018  
Individual/Entity: **Valentino Italian Restaurant**  
Facility: Valentino Italian Restaurant  
Location: 323 Highway 17 North  
Surfside Beach, SC 29575  
Mailing Address: Same  
County: Horry  
Previous Orders: 2016-206-04-006 (\$800.00);

Permit Number: 2017-206-06-052 (\$400.00)  
Violations Cited: 26-206-11890  
S.C. Code Ann. Regs. 61-25

Summary: Valentino Italian Restaurant (Individual/Entity), located in Surfside Beach, South Carolina, is a restaurant. The Department conducted inspections on January 25, 2018, and June 28, 2018. The Individual/Entity has violated the South Carolina Retail Food Establishment Regulation as follows: failed to use effective methods to cool cooked time/temperature control for safety foods.

Action: The Individual/Entity is required is required to: operate and maintain the facility in accordance with the requirements of all applicable regulations, including S.C. Regs. 61-25, and pay a civil penalty in the amount of one thousand dollars (**\$1,000.00**).

245) Order Type and Number: Consent Order 2018-206-03-041  
Order Date: August 10, 2018  
Individual/Entity: **Persis**  
Facility: Persis  
Location: 1728 Bush River Road  
Columbia, SC 29210  
Mailing Address: 15018 Bridle Trace Lane  
Pineville, NC 28134  
County: Lexington  
Previous Orders: 2017-206-03-009 (\$1,600.00)  
Permit Number: 32-206-06495  
Violations Cited: S.C. Code Ann. Regs. 61-25

Summary: Persis (Individual/Entity), located in Columbia, South Carolina, is a restaurant. The Department conducted inspections on March 21, 2017, May 16, 2017, April 18, 2018, and April 26, 2018. The Individual/Entity has violated the South Carolina Retail Food Establishment Regulation as follows: failed to maintain proper holding temperatures of time/temperature control for safety foods, failed to demonstrate knowledge of foodborne disease prevention by having no priority violations during the inspection, and failed to clearly mark the date by which food shall be consumed on the premises, sold, or discarded when held at a temperature of 41°F or less for a maximum of seven (7) days. This applies only to refrigerated, ready-to-eat, time/temperature control for safety foods prepared and held in a food establishment for more than twenty-four (24) hours.

Action: The Individual/Entity is required is required to: operate and maintain the facility in accordance with the requirements of all applicable regulations, including S.C. Regs. 61-25, and pay a civil penalty in the amount of two thousand, five hundred dollars (**\$2,500.00**).

246) Order Type and Number: Consent Order 2018-206-03-096  
Order Date: August 10, 2018  
Individual/Entity: **Italian Garden Restaurant**  
Facility: Italian Garden Restaurant  
Location: 59 US Highway 321 Bypass North  
Winnsboro, SC 29180  
Mailing Address: Same  
County: Fairfield  
Previous Orders: None  
Permit Number: 20-206-01625  
Violations Cited: S.C. Code Ann. Regs. 61-25

Summary: Italian Garden Restaurant (Individual/Entity), located in Winnsboro, South Carolina, is a restaurant. The Department conducted inspections on July 13, 2016, July 12, 2017, July 21, 2017, September 19, 2017, June 12, 2018, June 13, 2018, and July 11, 2018. The Individual/Entity has violated the South Carolina Retail Food Establishment Regulation as follows: failed to ensure that a person in charge is certified by a food protection manager certification program that is recognized by the Conference for Food Protection, failed to keep food contact surfaces, nonfood contact surfaces, and utensils clean and free of accumulation of dust, dirt, food residue, and other debris, and failed to clearly mark the date by which food shall be consumed on the premises, sold, or discarded when held at a temperature of 41°F or less for a maximum of seven (7) days. This applies only to refrigerated, ready-to-eat, time/temperature control for safety foods prepared and held in a food establishment for more than twenty-four (24) hours.

Action: The Individual/Entity is required is required to: operate and maintain the facility in accordance with the requirements of all applicable regulations, including S.C. Regs. 61-25, and pay a civil penalty in the amount of one thousand, two hundred dollars **(\$1,200.00)**.

247) Order Type and Number: Consent Order 2018-206-06-070  
Order Date: August 10, 2018  
Individual/Entity: **Wicked Tuna**  
Facility: Wicked Tuna  
Location: 4123 Highway 17 Business  
Murrells Inlet, SC 29576  
Mailing Address: Same  
County: Georgetown  
Previous Orders: 2016-206-06-087 (\$800.00);  
2017-206-06-030 (\$1,200.00);  
2017-206-06-129 (\$1,000.00)  
Permit Number: 22-206-06214  
Violations Cited: S.C. Code Ann. Regs. 61-25

Summary: Wicked Tuna (Individual/Entity), located in Murrells Inlet, South Carolina, is a restaurant. The Department conducted an inspection on June 26, 2018. The Individual/Entity has violated the South Carolina Retail Food Establishment Regulation as follows: failed to maintain proper holding temperatures of time/temperature control for safety foods.

Action: The Individual/Entity is required is required to: operate and maintain the facility in accordance with the requirements of all applicable regulations, including S.C. Regs. 61-25, and pay a civil penalty in the amount of one thousand dollars **(\$1,000.00)**.

248) Order Type and Number: Consent Order 2018-206-02-040  
Order Date: August 13, 2018  
Individual/Entity: **Sushi Go**  
Facility: Sushi Go  
Location: 247 North Main Street  
Greenville, SC 29601  
Mailing Address: Same  
County: Greenville  
Previous Orders: None  
Permit Number: 23-206-11272  
Violations Cited: S.C. Code Ann. Regs. 61-25

Summary: Sushi Go (Individual/Entity), located in Greenville, South Carolina, is a restaurant. The Department conducted inspections on December 2, 2016, September 12, 2017, and July 5, 2018. The Individual/Entity has violated the South Carolina Retail Food Establishment Regulation as follows: failed to ensure that when time without temperature control is used as a public health control, the food in unmarinated containers or packages shall be discarded.

Action: The Individual/Entity is required to: operate and maintain the facility in accordance with the requirements of all applicable regulations, including S.C. Regs. 61-25, and pay a civil penalty in the amount of eight hundred dollars (**\$800.00**).

249) Order Type and Number: Consent Order 2018-206-07-013  
Order Date: August 13, 2018  
Individual/Entity: **Virginia's on King**  
Facility: Virginia's on King  
Location: 412 King Street  
Charleston, SC 29403  
Mailing Address: Same  
County: Charleston  
Previous Orders: None  
Permit Number: 10-206-06339  
Violations Cited: S.C. Code Ann. Regs. 61-25

Summary: Virginia's on King (Individual/Entity), located in Charleston, South Carolina, is a restaurant. The Department conducted inspections on May 17, 2016, May 11, 2017, April 18, 2018, and April 27, 2018. The Individual/Entity has violated the South Carolina Retail Food Establishment Regulation as follows: failed to maintain proper holding temperatures of time/temperature control for safety foods.

Action: The Individual/Entity is required to: operate and maintain the facility in accordance with the requirements of all applicable regulations, including S.C. Regs. 61-25, and pay a civil penalty in the amount of one thousand, three hundred fifty dollars (**\$1,350.00**).

250) Order Type and Number: Consent Order 2018-206-07-017  
Order Date: August 13, 2018  
Individual/Entity: **Circle K**  
Facility: Circle K  
Location: 1305 Long Grove Drive  
Mount Pleasant, SC 29464  
Mailing Address: P.O. Box 8019  
Cary, NC 27512  
County: Charleston  
Previous Orders: None  
Permit Number: 10-206-09861  
Violations Cited: S.C. Code Ann. Regs. 61-25

Summary: Circle K (Individual/Entity), located in Charleston, South Carolina, is a convenience store. The Department conducted inspections on August 25, 2017, April 30, 2018, May 1, 2018, May 2, 2018, May 8, 2018, and May 14, 2018. The Individual/Entity has violated the South Carolina Retail Food Establishment Regulation as follows: failed to maintain proper holding temperatures of time/temperature control for safety foods, failed to ensure that a person in charge, is certified by a food protection manager certification program that is recognized by the Conference for Food Protection, and failed to pro

equipment sufficient in number and capacity to maintain food temperatures for cooling and heating food and holding cold and hot food.

Action: The Individual/Entity is required is required to: operate and maintain the facility in accordance with the requirements of all applicable regulations, including S.C. Regs. 61-25, and pay a civil penalty in the amount of three thousand, two hundred dollars **(\$3,200.00)**.

251) Order Type and Number: Consent Order 2018-206-03-079  
Order Date: August 14, 2018  
Individual/Entity: **Fusion Bowl Asian Bistro**  
Facility: Fusion Bowl Asian Bistro  
Location: 5166-E Sunset Boulevard  
Lexington, SC 29072  
Mailing Address: Same  
County: Lexington  
Previous Orders: None  
Permit Number: 32-206-05480  
Violations Cited: S.C. Code Ann. Regs. 61-25

Summary: Fusion Bowl Asian Bistro (Individual/Entity), located in Lexington, South Carolina, is a restaurant. The Department conducted inspections on June 23, 2016, June 19, 2017, and June 19, 2018. The Individual/Entity has violated the South Carolina Retail Food Establishment Regulation as follows: failed to maintain proper holding temperatures of time/temperature control for safety foods.

Action: The Individual/Entity is required to: operate and maintain the facility in accordance with the requirements of all applicable regulations, including S.C. Regs. 61-25, and pay a civil penalty in the amount of eight hundred dollars **(\$800.00)**.

252) Order Type and Number: Consent Order 2018-206-03-081  
Order Date: August 14, 2018  
Individual/Entity: **Local Market #4**  
Facility: Local Market #4  
Location: 4001 Celanese Road  
Rock Hill, SC 29730  
Mailing Address: P.O. Box 68  
Gastonia, NC 28053  
County: York  
Previous Orders: None  
Permit Number: 46-206-03395  
Violations Cited: S.C. Code Ann. Regs. 61-25

Summary: Local Market #4 (Individual/Entity), located in Rock Hill, South Carolina, is a convenience store. The Department conducted inspections on March 17, 2017, February 27, 2018, and June 28, 2018. The Individual/Entity has violated the South Carolina Retail Food Establishment Regulation as follows: failed to maintain proper holding temperatures of time/temperature control for safety foods.

Action: The Individual/Entity is required to: operate and maintain the facility in accordance with the requirements of all applicable regulations, including S.C. Regs. 61-25, and pay a civil penalty in the amount of eight hundred dollars **(\$800.00)**.

253) Order Type and Number: Consent Order 2018-206-03-085  
Order Date: August 14, 2018  
Individual/Entity: **Cyclone Drive In**  
Facility: Cyclone Drive In  
Location: 249 Columbia Street  
Chester, SC 29706  
Mailing Address: Same  
County: Chester  
Previous Orders: None  
Permit Number: 12-206-00648  
Violations Cited: S.C. Code Ann. Regs. 61-25

Summary: Cyclone Drive In (Individual/Entity), located in Chester, South Carolina, is a restaurant. The Department conducted inspections on June 29, 2016, June 27, 2017, and June 27, 2018. The Individual/Entity has violated the South Carolina Retail Food Establishment Regulation as follows: failed to ensure that when time without temperature control is used as a public health control, the food in unmarked containers or packages shall be discarded and failed to clearly mark the date by which food shall be consumed on the premises, sold, or discarded when held at a temperature of 41°F or less for a maximum of seven (7) days. This applies only to refrigerated, ready-to-eat, time/temperature control for safety foods prepared and held in a food establishment for more than twenty-four (24) hours.

Action: The Individual/Entity is required to: operate and maintain the facility in accordance with the requirements of all applicable regulations, including S.C. Regs. 61-25, and pay a civil penalty in the amount of eight hundred dollars (**\$800.00**).

254) Order Type and Number: Consent Order 2018-206-06-050  
Order Date: August 14, 2018  
Individual/Entity: **Little Pigs Bar-B-Q**  
Facility: Little Pigs Bar-B-Q  
Location: 6102 Frontage Road  
Myrtle Beach, SC 29577  
Mailing Address: Same  
County: Horry  
Previous Orders: None  
Permit Number: 26-206-07728  
Violations Cited: S.C. Code Ann. Regs. 61-25

Summary: Little Pigs Bar-B-Q (Individual/Entity), located in Myrtle Beach, South Carolina, is a restaurant. The Department conducted inspections on September 1, 2017, January 11, 2018, and May 1, 2018. The Individual/Entity has violated the South Carolina Retail Food Establishment Regulation as follows: failed to maintain proper holding temperatures of time/temperature control for safety foods.

Action: The Individual/Entity is required to: operate and maintain the facility in accordance with the requirements of all applicable regulations, including S.C. Regs. 61-25, and pay a civil penalty in the amount of five hundred fifty dollars (**\$550.00**).

255) Order Type and Number: Consent Order 2018-206-06-080  
Order Date: August 14, 2018  
Individual/Entity: **Wendy's #209**  
Facility: Wendy's #209  
Location: 95 South Kings Highway



Mailing Address: North Myrtle Beach, SC 29582  
8040 Arrowridge Boulevard  
Charlotte, NC 28273  
County: Horry  
Previous Orders: None  
Permit Number: 26-206-07265  
Violations Cited: S.C. Code Ann. Regs. 61-25

Summary: Wendy's #209 (Individual/Entity), located in North Myrtle Beach, South Carolina, is a restaurant. The Department conducted inspections on November 8, 2017, April 18, 2018, and June 25, 2018. The Individual/Entity has violated the South Carolina Retail Food Establishment Regulation as follows: failed to ensure written procedures were in place and made available to the Department when the facility uses time as a public health control.

Action: The Individual/Entity is required to: operate and maintain the facility in accordance with the requirements of all applicable regulations, including S.C. Regs. 61-25, and pay a civil penalty in the amount of eight hundred dollars (**\$800.00**).

256) Order Type and Number: Consent Order 2018-206-07-019  
Order Date: August 14, 2018  
Individual/Entity: **Noisy Oyster Market Street**  
Facility: Noisy Oyster Market Street  
Location: 24 North Market Street  
Charleston, SC 29401  
Mailing Address: P.O. Box 2446  
Mount Pleasant, SC 29465  
County: Charleston  
Previous Orders: 2015-206-07-008 (\$500.00);  
2015-206-07-070 (\$800.00)  
Permit Number: 10-206-05000  
Violations Cited: S.C. Code Ann. Regs. 61-25

Summary: Noisy Oyster Market Street (Individual/Entity), located in Charleston, South Carolina, is a restaurant. The Department conducted inspections on November 10, 2016, October 11, 2017, April 25, 2018, May 1, 2018, and May 11, 2018. The Individual/Entity has violated the South Carolina Retail Food Establishment Regulation as follows: failed to keep shellstock tags or labels attached to the container in which the shellstock are received, until the container is empty, failed to properly thaw time/temperature control for safety foods, failed to keep food contact surfaces, nonfood contact surfaces, and utensils clean and free of accumulation of dust, dirt, food residue, and other debris, and failed to clean the physical facilities as often as necessary to keep them clean.

Action: The Individual/Entity is required is required to: operate and maintain the facility in accordance with the requirements of all applicable regulations, including S.C. Regs. 61-25, and pay a civil penalty in the amount of one thousand dollars (**\$1,000.00**).

257) Order Type and Number: Consent Order 2018-206-07-044  
Order Date: August 14, 2018  
Individual/Entity: **Noisy Oyster**  
Facility: Noisy Oyster  
Location: 24 North Market Street  
Charleston, SC 29401

Mailing Address: P.O. Box 2446  
Mount Pleasant, SC 29465  
County: Charleston  
Previous Orders: 2015-206-07-008 (\$500.00);  
2015-206-07-070 (\$800.00)  
Permit Number: 10-206-05000  
Violations Cited: S.C. Code Ann. Regs. 61-25

Summary: Noisy Oyster (Individual/Entity), located in Charleston, South Carolina, is a restaurant. The Department conducted inspections on October 11, 2017, April 25, 2018, and July 12, 2018. Individual/Entity has violated the South Carolina Retail Food Establishment Regulation as follows: failed to maintain proper holding temperatures of time/temperature control for safety foods and failed to provide equipment sufficient in number and capacity to maintain food temperatures for cooling and heating food and holding cold and hot food.

Action: The Individual/Entity is required is required to: operate and maintain the facility in accordance with the requirements of all applicable regulations, including S.C. Regs. 61-25, and pay a civil penalty in the amount of one thousand dollars (**\$1,000.00**).

258) Order Type and Number: Consent Order 2018-206-02-041  
Order Date: August 17, 2018  
Individual/Entity: **Project Host**  
Facility: Project Host  
Location: 525 South Academy Street  
Greenville, SC 29602  
Mailing Address: P.O. Box 345  
Greenville, SC 29602  
County: Greenville  
Previous Orders: 2018-206-02-020 (\$800.00)  
Permit Number: 23-206-05927  
Violations Cited: S.C. Code Ann. Regs. 61-25

Summary: Project Host (Individual/Entity), located in Greenville, South Carolina, is a restaurant. The Department conducted an inspection on July 2, 2018. The Individual/Entity has violated the South Carolina Retail Food Establishment Regulation as follows: failed to ensure that when time without temperature control is used as a public health control, the food in unmarked containers or packages shall be discarded.

Action: The Individual/Entity is required is required to: operate and maintain the facility in accordance with the requirements of all applicable regulations, including S.C. Regs. 61-25, and pay a civil penalty in the amount of one thousand dollars (**\$1,000.00**).

259) Order Type and Number: Consent Order 2018-206-02-042  
Order Date: August 17, 2018  
Individual/Entity: **Grill Marks**  
Facility: Grill Marks  
Location: 209 South Main Street  
Greenville, SC 29601  
Mailing Address: Same  
County: Greenville  
Previous Orders: 2016-206-02-037 (\$800.00);

Permit Number: 2016-206-02-019 (\$800.00)  
Violations Cited: 23-206-10591  
S.C. Code Ann. Regs. 61-25

Summary: Grill Marks (Individual/Entity), located in Greenville, South Carolina, is a restaurant. The Department conducted inspections on February 9, 2017, November 3, 2017, June 28, 2018, and July 3, 2018. The Individual/Entity has violated the South Carolina Retail Food Establishment Regulation as follows: failed to maintain proper holding temperatures of time/temperature control for safety foods and failed to ensure that when time without temperature control is used as a public health control, the food in unmarked containers or packages shall be discarded.

Action: The Individual/Entity is required to: operate and maintain the facility in accordance with the requirements of all applicable regulations, including S.C. Regs. 61-25, and pay a civil penalty in the amount of one thousand, six hundred dollars **(\$1,600.00)**.

260) Order Type and Number: Consent Order 2018-206-03-077  
Order Date: August 17, 2018  
Individual/Entity: **Zaxby's**  
Facility: Zaxby's  
Location: 3401 Highway 21  
Fort Mill, SC 29715  
Mailing Address: 1040 Founders Boulevard  
Athens, GA 30606  
County: York  
Previous Orders: None  
Permit Number: 46-206-03318  
Violations Cited: S.C. Code Ann. Regs. 61-25

Summary: Zaxby's (Individual/Entity), located in Fort Mill, South Carolina, is a restaurant. The Department conducted inspections on May 17, 2017, August 22, 2017, and June 6, 2018. The Individual/Entity has violated the South Carolina Retail Food Establishment Regulation as follows: failed to maintain proper holding temperatures of time/temperature control for safety foods.

Action: The Individual/Entity is required to: operate and maintain the facility in accordance with the requirements of all applicable regulations, including S.C. Regs. 61-25, and pay a civil penalty in the amount of eight hundred dollars **(\$800.00)**.

261) Order Type and Number: Consent Order 2018-206-03-099  
Order Date: August 17, 2018  
Individual/Entity: **Subway**  
Facility: Subway  
Location: 2700 Broad River Road  
Columbia, SC 29210  
Mailing Address: Same  
County: Richland  
Previous Orders: None  
Permit Number: 40-206-04970  
Violations Cited: S.C. Code Ann. Regs. 61-25

Summary: Subway (Individual/Entity), located in Columbia, South Carolina, is a restaurant. The Department conducted inspections on October 3, 2016, September 12, 2017, and June 29, 2018. The

Individual/Entity has violated the South Carolina Retail Food Establishment Regulation as follows: failed to maintain proper holding temperatures of time/temperature control for safety foods.

Action: The Individual/Entity is required to: operate and maintain the facility in accordance with the requirements of all applicable regulations, including S.C. Regs. 61-25, and pay a civil penalty in the amount of five hundred fifty dollars **(\$550.00)**.

262) Order Type and Number: Consent Order 2018-206-06-044  
Order Date: August 17, 2018  
Individual/Entity: **Hard Rock Café**  
Facility: Hard Rock Café  
Location: 1318 Celebrity Circle, Unit 179  
Myrtle Beach, SC 29577  
Mailing Address: 6100 Old Park Lane  
Orlando, FL 32835  
County: Horry  
Previous Orders: 2017-206-06-096 (\$800.00)  
Permit Number: 26-206-13321  
Violations Cited: S.C. Code Ann. Regs. 61-25

Summary: Hard Rock Café (Individual/Entity), located in Myrtle Beach, South Carolina, is a restaurant. The Department conducted an inspection on April 24, 2018. The Individual/Entity has violated the South Carolina Retail Food Establishment Regulation as follows: failed to maintain proper holding temperatures of time/temperature control for safety foods.

Action: The Individual/Entity is required is required to: operate and maintain the facility in accordance with the requirements of all applicable regulations, including S.C. Regs. 61-25, and pay a civil penalty in the amount of one thousand dollars **(\$1,000.00)**.

263) Order Type and Number: Consent Order 2018-206-06-061  
Order Date: August 17, 2018  
Individual/Entity: **Cici's Pizza**  
Facility: Cici's Pizza  
Location: 3533 Northgate Road  
Myrtle Beach, SC 29577  
Mailing Address: 430 Ramsey Street, Suite 106  
Fayetteville, SC 28302  
County: Horry  
Previous Orders: 2017-206-06-128 (\$800.00)  
Permit Number: 26-206-10030  
Violations Cited: S.C. Code Ann. Regs. 61-25

Summary: Cici's Pizza (Individual/Entity), located in Myrtle Beach, South Carolina, is a restaurant. The Department conducted inspections on February 28, 2017, October 17, 2017, October 30, 2017, and May 29, 2018. The Individual/Entity has violated the South Carolina Retail Food Establishment Regulation as follows: failed to maintain proper holding temperatures of time/temperature control for safety foods, failed to properly cool cooked time/temperature control for safety foods and failed to use effective methods to cool cooked time/temperature control for safety foods.

Action: The Individual/Entity is required to: operate and maintain the facility in accordance with the requirements of all applicable regulations, including S.C. Regs. 61-25, and pay a civil penalty in the amount of one thousand, two hundred fifty dollars **(\$1,250.00)**.

264) Order Type and Number: Consent Order 2018-206-07-026  
Order Date: August 17, 2018  
Individual/Entity: **Five Loaves Café**  
Facility: Five Loaves Café  
Location: 43 Cannon Street  
Charleston, SC 29403  
Mailing Address: 4 Carriage Lane, Suite 400F  
Charleston, SC 29407  
County: Charleston  
Previous Orders: 2016-206-07-066 (\$800.00)  
Permit Number: 10-206-04363  
Violations Cited: S.C. Code Ann. Regs. 61-25

Summary: Five Loaves Café (Individual/Entity), located in Charleston, South Carolina, is a restaurant. The Department conducted inspections on August 1, 2016, July 11, 2017, May 31, 2018, and June 1, 2018. The Individual/Entity has violated the South Carolina Retail Food Establishment Regulation as follows: failed to maintain proper holding temperatures of time/temperature control for safety foods, failed to use effective methods to cool cooked time/temperature control for safety foods, and failed to ensure that when time without temperature control is used as a public health control, the food in unmar containers or packages shall be discarded.

Action: The Individual/Entity is required to: operate and maintain the facility in accordance with the requirements of all applicable regulations, including S.C. Regs. 61-25, and pay a civil penalty in the amount of three thousand dollars **(\$3,000.00)**.

265) Order Type and Number: Consent Order 2018-206-07-045  
Order Date: August 17, 2018  
Individual/Entity: **Wendy's #107-002**  
Facility: Wendy's #107-002  
Location: 4113 Rivers Avenue  
North Charleston, SC 29405  
Mailing Address: 27 Central Avenue  
Cortland, NY 13045  
County: Charleston  
Previous Orders: None  
Permit Number: 10-206-06789  
Violations Cited: S.C. Code Ann. Regs. 61-25

Summary: Wendy's #107-002 (Individual/Entity), located in North Charleston, South Carolina, is a restaurant. The Department conducted inspections on July 28, 2017, July 18, 2018, and July 24, 2018. The Individual/Entity has violated the South Carolina Retail Food Establishment Regulation as follows: fa to maintain proper holding temperatures of time/temperature control for safety foods.

Action: The Individual/Entity is required to: operate and maintain the facility in accordance with the requirements of all applicable regulations, including S.C. Regs. 61-25, and pay a civil penalty in the amount of eight hundred dollars **(\$800.00)**.

266) Order Type and Number: Consent Order 2018-204-03-004  
Order Date: August 20, 2018  
Individual/Entity: **Tacos Nayarit #2 MJ Mart**  
Facility: Tacos Nayarit #2 MJ Mart  
Location: 9775 Charlotte Highway  
Indian Land, SC 29707  
Mailing Address: 2240 Linwood Street  
Rock Hill, SC 29732  
County: Lancaster  
Previous Orders: None  
Permit Number: 29-204-01552  
Violations Cited: S.C. Code Ann. Regs. 61-25

Summary: Tacos Nayarit #2 MJ Mart (Individual/Entity), located in Indian Land, South Carolina, is a mobile food unit. The Department conducted inspections on July 12, 2017, July 21, 2017, June 14, 2018, June 22, 2018, and June 29, 2018. The Individual/Entity has violated the South Carolina Retail Food Establishment Regulation as follows: failed to maintain proper holding temperatures of time/temperature control for safety foods and failed to maintain the premises free of insects, rodents, and other pests.

Action: The Individual/Entity is required to: operate and maintain the facility in accordance with the requirements of all applicable regulations, including S.C. Regs. 61-25, and pay a civil penalty in the amount of two thousand, five hundred dollars **(\$2,500.00)**.

267) Order Type and Number: Consent Order 2018-206-03-080  
Order Date: August 20, 2018  
Individual/Entity: **Waffle House #1120**  
Facility: Waffle House #1120  
Location: 1049 South Anderson Road  
Rock Hill, SC 29730  
Mailing Address: P.O. Box 6450  
Norcross, GA 30091  
County: York  
Previous Orders: None  
Permit Number: 46-206-01202  
Violations Cited: S.C. Code Ann. Regs. 61-25

Summary: Waffle House #1120 (Individual/Entity), located in Rock Hill, South Carolina, is a restaurant. The Department conducted inspections on August 31, 2016, August 31, 2017, and June 29, 2018. The Individual/Entity has violated the South Carolina Retail Food Establishment Regulation as follows: failed to maintain proper holding temperatures of time/temperature control for safety foods.

Action: The Individual/Entity is required to: operate and maintain the facility in accordance with the requirements of all applicable regulations, including S.C. Regs. 61-25, and pay a civil penalty in the amount of eight hundred dollars **(\$800.00)**.

268) Order Type and Number: Consent Order 2018-206-06-079  
Order Date: August 20, 2018  
Individual/Entity: **Woodhaven Pancake House**  
Facility: Woodhaven Pancake House  
Location: 2600 South Kings Highway  
Myrtle Beach, SC 29577

Mailing Address: Same  
County: Horry  
Previous Orders: 2016-206-06-097 (\$1,200.00)  
Permit Number: 26-206-06962  
Violations Cited: S.C. Code Ann. Regs. 61-25

Summary: Woodhaven Pancake House (Individual/Entity), located in Myrtle Beach, South Carolina is a restaurant. The Department conducted inspections on May 24, 2018, June 29, 2018, and July 6, 2018. The Individual/Entity has violated the South Carolina Retail Food Establishment Regulation as follows: failed to maintain proper holding temperatures of time/temperature control for safety foods.

Action: The Individual/Entity is required to: operate and maintain the facility in accordance with the requirements of all applicable regulations, including S.C. Regs. 61-25, and pay a civil penalty in the amount of eight hundred dollars (**\$800.00**).

269) Order Type and Number: Consent Order 2018-206-06-073  
Order Date: August 21, 2018  
Individual/Entity: **Zaxby's #1302**  
Facility: Zaxby's #1302  
Location: 100 Strand Market Drive  
Myrtle Beach, SC 29588  
Mailing Address: 1816 Wall Street  
Florence, SC 29501  
County: Horry  
Previous Orders: 2016-206-06-079 (\$800.00)  
Permit Number: 26-206-09397  
Violations Cited: S.C. Code Ann. Regs. 61-25

Summary: Zaxby's #1302 (Individual/Entity), located in Myrtle Beach, South Carolina, is a restaurant. The Department conducted inspections on June 30, 2017, December 1, 2017, and June 15, 2018. The Individual/Entity has violated the South Carolina Retail Food Establishment Regulation as follows: failed to maintain proper holding temperatures of time/temperature control for safety foods.

Action: The Individual/Entity is required to: operate and maintain the facility in accordance with the requirements of all applicable regulations, including S.C. Regs. 61-25, and pay a civil penalty in the amount of one thousand dollars (**\$1,000.00**).

270) Order Type and Number: Consent Order 2018-206-07-024  
Order Date: August 21, 2018  
Individual/Entity: **Nigels Good Food**  
Facility: Nigels Good Food  
Location: 3760 Ashley Phosphate Road  
North Charleston, SC 29406  
Mailing Address: Same  
County: Dorchester  
Previous Orders: None  
Permit Number: 18-206-07836  
Violations Cited: S.C. Code Ann. Regs. 61-25

Summary: Nigels Good Food (Individual/Entity), located in North Charleston, South Carolina, is a restaurant. The Department conducted inspections on February 6, 2017, June 15, 2017, and May 24, 2018.

The Individual/Entity has violated the South Carolina Retail Food Establishment Regulation as follows: failed to maintain proper holding temperatures of time/temperature control for safety foods and failed to ensure that when time without temperature control is used as a public health control, the food in unmarked containers or packages shall be discarded.

Action: The Individual/Entity is required to: operate and maintain the facility in accordance with the requirements of all applicable regulations, including S.C. Regs. 61-25, and pay a civil penalty in the amount of eight hundred dollars **(\$800.00)**.

271) Order Type and Number: Consent Order 2018-206-07-035  
Order Date: August 21, 2018  
Individual/Entity: **Pan Super Buffet**  
Facility: Pan Super Buffet  
Location: 9970 Dorchester Road, Unit C  
Summerville, SC 29485  
Mailing Address: Same  
County: Dorchester  
Previous Orders: 2015-206-07-046 (\$800.00);  
2016-206-07-035 (\$600.00);  
2017-206-07-008 (\$1,600.00)  
Permit Number: 18-206-07403  
Violations Cited: S.C. Code Ann. Regs. 61-25

Summary: Pan Super Buffet (Individual/Entity), located in Summerville, South Carolina, is a restaurant. The Department conducted inspections on May 2, 2018, and June 26, 2018. The Individual/Entity has violated the South Carolina Retail Food Establishment Regulation as follows: failed to maintain proper holding temperatures of time/temperature control for safety foods.

Action: The Individual/Entity is required to: operate and maintain the facility in accordance with the requirements of all applicable regulations, including S.C. Regs. 61-25, and pay a civil penalty in the amount of two thousand dollars **(\$2,000.00)**.

272) Order Type and Number: Consent Order 2018-206-07-025  
Order Date: August 22, 2018  
Individual/Entity: **Page's Okra Grill**  
Facility: Page's Okra Grill  
Location: 302 Coleman Boulevard  
Mount Pleasant, SC 29464  
Mailing Address: Same  
County: Charleston  
Previous Orders: None  
Permit Number: 10-206-07965  
Violations Cited: S.C. Code Ann. Regs. 61-25

Summary: Page's Okra Grill (Individual/Entity), located in Mount Pleasant, South Carolina, is a restaurant. The Department conducted inspections on May 22, 2017, May 21, 2018, and May 31, 2018. The Individual/Entity has violated the South Carolina Retail Food Establishment Regulation as follows: failed to maintain proper holding temperatures of time/temperature control for safety foods.



Action: The Individual/Entity is required to: operate and maintain the facility in accordance with the requirements of all applicable regulations, including S.C. Regs. 61-25, and pay a civil penalty in the amount of eight hundred dollars (**\$800.00**).

273) Order Type and Number: Consent Order 2018-206-07-039  
Order Date: August 22, 2018  
Individual/Entity: **JD's Market**  
Facility: JD's Market  
Location: 614 Rutledge Avenue  
Charleston, SC 29403  
Mailing Address: Same  
County: Charleston  
Previous Orders: 2018-206-07-012 (\$800.00)  
Permit Number: 10-206-09623  
Violations Cited: S.C. Code Ann. Regs. 61-25

Summary: JD's Market (Individual/Entity), located in Charleston, South Carolina, is a restaurant. The Department conducted inspections on April 13, 2017, March 30, 2018, April 10, 2018, April 23, 2018, May 2, 2018, and June 21, 2018. The Individual/Entity has violated the South Carolina Retail Food Establishment Regulation as follows: failed to ensure that a person in charge is certified by a food protection manager certification program that is recognized by the Conference for Food Protection.

Action: The Individual/Entity is required to: operate and maintain the facility in accordance with the requirements of all applicable regulations, including S.C. Regs. 61-25, and pay a civil penalty in the amount of eight hundred dollars (**\$800.00**).

274) Order Type and Number: Consent Order 2018-206-07-046  
Order Date: August 22, 2018  
Individual/Entity: **Reggae Grill Caribbean Cuisine**  
Facility: Reggae Grill Caribbean Cuisine  
Location: 4226 Rivers Avenue  
North Charleston, SC 29405  
Mailing Address: Same  
County: Charleston  
Previous Orders: None  
Permit Number: 10-206-09235  
Violations Cited: S.C. Code Ann. Regs. 61-25

Summary: Reggae Grill Caribbean Cuisine (Individual/Entity), located in North Charleston, South Carolina, is a restaurant. The Department conducted inspections on August 25, 2016, July 26, 2017, and July 18, 2018. The Individual/Entity has violated the South Carolina Retail Food Establishment Regulation as follows: failed to ensure that when time without temperature control is used as a public health control the food in unmarked containers or packages shall be discarded.

Action: The Individual/Entity is required to: operate and maintain the facility in accordance with the requirements of all applicable regulations, including S.C. Regs. 61-25, and pay a civil penalty in the amount of eight hundred dollars (**\$800.00**).

275) Order Type and Number: Consent Order 2018-206-07-043  
Order Date: August 23, 2018  
Individual/Entity: **Tavern and Table**  
Facility: Tavern and Table  
Location: 100 Church Street  
Mount Pleasant, SC 29464  
Mailing Address: Same  
County: Charleston  
Previous Orders: 2016-206-07-065 (\$1,000.00)  
Permit Number: 10-206-09406  
Violations Cited: S.C. Code Ann. Regs. 61-25

Summary: Tavern and Table (Individual/Entity), located in Mount Pleasant, South Carolina, is a restaurant. The Department conducted inspections on July 18, 2016, July 18, 2017, and July 17, 2018. The Individual/Entity has violated the South Carolina Retail Food Establishment Regulation as follows: failed to maintain proper holding temperatures of time/temperature control for safety foods and failed to provide documentation required by the regulation to the Department to request a variance.

Action: The Individual/Entity is required to: operate and maintain the facility in accordance with the requirements of all applicable regulations, including S.C. Regs. 61-25, and pay a civil penalty in the amount of one thousand dollars (**\$1,000.00**).

276) Order Type and Number: Consent Order 2018-206-03-109  
Order Date: August 27, 2018  
Individual/Entity: **New China Buffet**  
Facility: New China Buffet  
Location: 928 East Liberty Street  
York, SC 29745  
Mailing Address: Same  
County: York  
Previous Orders: None  
Permit Number: 46-206-03436  
Violations Cited: S.C. Code Ann. Regs. 61-25

Summary: New China Buffet (Individual/Entity), located in York, South Carolina, is a restaurant. The Department conducted inspections on May 23, 2017, July 20, 2017, and July 10, 2018. The Individual/Entity has violated the South Carolina Retail Food Establishment Regulation as follows: failed to maintain proper holding temperatures of time/temperature control for safety foods.

Action: The Individual/Entity is required to: operate and maintain the facility in accordance with the requirements of all applicable regulations, including S.C. Regs. 61-25, and pay a civil penalty in the amount of eight hundred dollars (**\$800.00**).

277) Order Type and Number: Consent Order 2018-206-07-036  
Order Date: August 27, 2018  
Individual/Entity: **Yadah Hospitality DBA Kanpai**  
Facility: Yadah Hospitality DBA Kanpai  
Location: 1035 Johnnie Dodds Boulevard, B-9  
Mount Pleasant, SC 29464  
Mailing Address: Same  
County: Charleston

Previous Orders: None  
Permit Number: 10-206-08683  
Violations Cited: S.C. Code Ann. Regs. 61-25

Summary: Yadah Hospitality DBA Kanpai (Individual/Entity), located in Mount Pleasant, South Carolina, is a restaurant. The Department conducted inspections on February 8, 2017, January 30, 2018, March 20, 2018, March 29, 2018, and May 22, 2018. The Individual/Entity has violated the South Carolina Retail Food Establishment Regulation as follows: failed to maintain proper holding temperatures time/temperature control for safety foods, failed to ensure that a person in charge, is certified by a food protection manager certification program that is recognized by the Conference for Food Protection, failed to ensure that the handwashing sinks were accessible at all times, failed to ensure that when time without temperature control is used as a public health control, the food in unmarked containers or packages shall be discarded and failed to clearly mark the date by which food shall be consumed on the premises, sold, or discarded when held at a temperature of 41°F or less for a maximum of seven (7) days. This applies only to refrigerated, ready-to-eat, time/temperature control for safety foods prepared and held in a food establishment for more than twenty-four (24) hours.

Action: The Individual/Entity is required to: operate and maintain the facility in accordance with the requirements of all applicable regulations, including S.C. Regs. 61-25, and pay a civil penalty in the amount of one thousand, two hundred dollars **(\$1,200.00)**.

### **Onsite Wastewater Enforcement**

278) Order Type and Number: Administrative Order 18-04-OSWW  
Order Date: June 8, 2018  
Individual/Entity: **Davis & Sons Plumbing & Maintenance, LLC**  
Facility: Davis & Sons Plumbing & Maintenance, LLC  
Location: 19 Dulamo Road  
Saint Helena, SC 29920  
Mailing Address: Same  
County: Beaufort  
Previous Orders: None  
Permit Number: None  
Violations Cited: S.C. Code Ann. Regs. 61-56

Summary: Davis & Sons Plumbing & Maintenance, LLC (Individual/Entity) operates as an unlicensed Onsite Wastewater (OSWW) system contractor located in Saint Helena, South Carolina. The Department received a complaint about repairs made to an OSWW system by Davis & Sons Plumbing & Maintenance, LLC. The Individual/Entity has violated the South Carolina License to Construct or Clean Onsite Sewage Treatment and Disposal Systems and Self-Contained Toilets Regulation as follows: engaged in the business of and was responsible for the construction, repair, or cleaning of onsite sewage treatment and disposal systems in South Carolina without first applying for, receiving, and subsequently maintaining a valid license to conduct such activities, as required by the Department.

Action: The Individual/Entity is required to: immediately cease and desist engaging in the business of construction, repair, or cleaning of onsite sewage treatment and disposal systems in South Carolina without a valid Department-issued license; and pay a civil penalty in the amount of five hundred dollars **(\$500.00)**.

279) Order Type and Number: Administrative Order 18-01-OSWW  
Order Date: August 8, 2018  
Individual/Entity: **Jeana Tart**  
Facility: Jeana Tart  
Location: 4412 Clover Court  
Mullins, SC 29574  
Mailing Address: 3939 Gladiola Court #201  
Myrtle Beach, SC 29588  
County: Marion  
Previous Orders: None  
Permit Number: None  
Violations Cited: S.C. Code Ann. Regs. 61-56

Summary: Jeana Tart (Individual/Entity) owns property located in Mullins, South Carolina. The Department conducted a complaint investigation on August 30, 2017 and observed the discharge of wastewater to the surface of the ground. The Individual/Entity has violated the South Carolina Onsite Wastewater Systems (OSWW) Regulation as follows: failed to ensure that no septic tank effluent or domestic wastewater or sewage was discharged to the surface of the ground without an appropriate permit from the Department.

Action: The Individual/Entity is required to: repair the OSWW system to immediately stop the discharging of wastewater to the surface of the ground or immediately vacate the residence to eliminate the discharge of wastewater to the OSWW system and ensure the residence remains vacated until adequate repairs had been made to the OSWW system to eliminate the discharges; ensure that all repairs to the OSWW system are performed by a Department-licensed OSWW system installer; submit records of all repairs performed within five (5) days of the repair(s); and pay a civil penalty in the amount of seven hundred fifty dollars (**\$750.00**).

280) Order Type and Number: Administrative Order 18-09-OSWW  
Order Date: August 9, 2018  
Individual/Entity: **Charles Bowker, III**  
Facility: Charles Bowker, III  
Location: 1206 Heritage Court  
Fort Mill, SC 29715  
Mailing Address: Same  
County: York  
Previous Orders: None  
Permit Number: None  
Violations Cited: S.C. Code Ann. Regs. 61-56

Summary: Charles Bowker, III (Individual/Entity) owns property located in Fort Mill, South Carolina. The Department conducted a complaint investigation on October 20, 2017 and observed the discharge of wastewater to the surface of the ground. The Individual/Entity has violated the South Carolina Onsite Wastewater Systems (OSWW) Regulation as follows: failed to ensure that no septic tank effluent or domestic wastewater or sewage was discharged to the surface of the ground without an appropriate permit from the Department.

Action: The Individual/Entity is required to: repair the OSWW system to effectively stop the discharging of wastewater to the surface of the ground or immediately vacate the residence to eliminate the discharge of wastewater to the OSWW system and ensure the residence remains vacated until adequate repairs had been made to the OSWW system to eliminate the discharges; ensure that all repairs to the OSWW system are performed by a Department-licensed OSWW system installer; submit records of all

repairs performed within five (5) days of the repair(s); and pay a civil penalty in the amount of seven hundred fifty dollars (**\$750.00**).

281) Order Type and Number: Consent Order 18-10-OSWW  
Order Date: July 10, 2018  
Individual/Entity: **James E. Martin**  
Facility: James E. Martin  
Location: 4503 Appaloosa Trail  
Conway, SC 29526  
Mailing Address: Same  
County: Horry  
Previous Orders: None  
Permit Number: None  
Violations Cited: S.C. Code Ann. Regs. 61-56

Summary: James E. Martin (Individual/Entity) owns property located in Conway, South Carolina. The Department conducted a complaint investigation on February 9, 2018 and observed the discharge of wastewater to the surface of the ground. The Individual/Entity has violated the South Carolina Onsite Wastewater Systems (OSWW) Regulation as follows: failed to ensure that no septic tank effluent domestic wastewater or sewage was discharged to the surface of the ground without an appropriate permit from the Department.

Action: The Individual/Entity is required to: repair the OSWW system to immediately stop the discharging of wastewater to the drainage ditch or immediately vacate the residence to eliminate the discharge of wastewater to the OSWW system and ensure the residence remains vacated until adequate repairs had been made to the OSWW system to eliminate the discharges.

282) Order Type and Number: Consent Order 18-12-OSWW  
Order Date: August 7, 2018  
Individual/Entity: **Harold L. Larimore**  
Facility: Harold L. Larimore  
Location: 1132 Lee Circle  
West Columbia, SC 29170  
Mailing Address: 2127 Kirkland Street  
West Columbia, SC 29169  
County: Lexington  
Previous Orders: None  
Permit Number: None  
Violations Cited: S.C. Code Ann. Regs. 61-56

Summary: Harold L. Larimore (Individual/Entity) owns property located in West Columbia, South Carolina. The Department conducted a complaint investigation on May 2, 2018 and observed the discharge of wastewater to the surface of the ground. The Individual/Entity has violated the South Carolina Onsite Wastewater Systems (OSWW) Regulation as follows: failed to ensure that no septic tank effluent domestic wastewater or sewage was discharged to the surface of the ground without an appropriate permit from the Department.

Action: The Individual/Entity is required to: repair the OSWW system to immediately stop the discharging of wastewater to the drainage ditch or immediately vacate the residence to eliminate the discharge of wastewater to the OSWW system and ensure the residence remains vacated until adequate repairs have been made to the OSWW system to eliminate the discharges.

283) Order Type and Number: Consent Order 18-13-OSWW  
Order Date: August 14, 2018  
Individual/Entity: **Jeremy Thames d.b.a. Thames Septic Services**  
Facility: Jeremy Thames d.b.a. Thames Septic Services  
Location: 870 Twin Lakes Drive  
Sumter, SC 29150  
Mailing Address: Same  
County: Sumter  
Previous Orders: None  
Permit Number: None  
Violations Cited: S.C. Code Ann. Regs. 61-56.1

Summary: Jeremy Thames d.b.a. Thames Septic Services (Individual/Entity) holds a Department-issued license to construct and engage in the cleaning of Onsite Wastewater Systems and Self-Contained Toilets. The Department conducted a complaint investigation on June 15, 2018, and observed domestic wastewater discharged onto the surface of the ground at the end of a dirt drive. The Individual/Entity has violated the South Carolina License to Construct or Clean Onsite Sewage Treatment and Disposal System and Self-Contained Toilets Regulation as follows: failed to ensure that disposal of septage shall be allowed only at facilities approved by the Department.

Action: The Individual/Entity is required to: operate in accordance with all applicable requirements of S.C. Code Ann. Regs. 61-56 and 64-56.1, including that all septage is disposed of only at facilities approved by the Department; ensure that any remaining solids or debris disposed of at the Site is removed, and treat the affected areas with pulverized or agricultural lime; and pay a civil penalty in the amount of one thousand dollars (**\$1,000.00**).

### **OFFICE OF OCEAN AND COASTAL RESOURCE MANAGEMENT**

284) Order Type and Number: Consent Order AF-0000137  
Order Date: June 27, 2018  
Individual/Entity: **Floyd LLC**  
Location: 3111 1st Avenue  
Murrells Inlet, SC 29576  
Mailing Address: 1245 Shull Island Road  
Gilbert, SC 29054  
County: Horry  
Previous Orders: None  
Permit/ID Number: CC-85-124GP  
Violations Cited: S.C. Code Ann. §48-39-130(A) and S.C. Code Ann. Regs. 30-2(B).

Summary: Floyd LLC (Individual/Entity) is the current owner of certain property abutting the tidelands critical area. An inspection at the site was conducted on April 7, 2017, and a Notice to Comply was issued on May 23, 2017. The Individual/Entity has violated the S.C. Coastal Zone Management Act and Coastal Division Regulations and is responsible for the construction of a ramp platform attached to the floating dock, a floating boat storage structure and the channelward movement of the floating dock in the tidelands critical area at the site without a permit from the Department.

Action: The Individual/Entity is required to: submit an administratively complete after-the-fact critical area permit request for the unauthorized modifications to the dock structure at the Site and pay civil penalty in the amount of one hundred dollars (**\$100.00**).

285) Order Type and Number: Consent Order AF-0000127  
Order Date: August 1, 2018  
Individual/Entity: **Palmetto Marine Construction, Inc.**  
Location: 310 5<sup>th</sup> Avenue North  
North Myrtle Beach, SC 29582  
Mailing Address: 2678 Mount Zion Road  
Little River, SC 29566  
County: Horry  
Previous Orders: None  
Permit/ID Number: OCRM00392/TMS #145-03-18-008  
Violations Cited: S.C. Code Ann. §48-39-130(A) and S.C. Code Ann. Regs. 30-2(B).

Summary: Palmetto Marine Construction, Inc. (Individual/Entity) is responsible for construction activities in the tidelands critical area at the Site without first receiving a permit from the Department. On September 28, 2017, Department staff conducted an inspection and observed an unauthorized dock structure that was recently constructed without authorization. The Department had previously worked with Palmetto Marine through compliance assistance efforts to resolve similar violations at other Sites. Due to Palmetto Marine's repeated actions in utilizing/altering the critical area without a permit, a Notice of Administrative Violation/Admission Letter was issued on April 10, 2018. The Individual/Entity has violated the S.C. Coastal Zone Management Act (Act) and Coastal Division Regulations (Regulations) as follows: constructed a walkway, ramp, and floating dock in the tidelands critical area at the Site without first receiving a permit from the Department.

Action: The Individual/Entity is required to: comply with all requirements of the Act and Regulations, including requesting and receiving any necessary Department permits prior to any future utilization/alteration of any South Carolina critical area; and pay a **suspended penalty** in the amount of one thousand, eight hundred dollars (**\$1,800.00**) should any requirement of the Order not be met.

\* Unless otherwise specified, "Previous Orders" as listed in this report include orders issued by Environmental Affairs Programs within the last five (5) years.

BOARD OF HEALTH AND ENVIRONMENTAL CONTROL

Summary Sheet  
October 11, 2018

Action

Information

I. SUBJECT: Placement of Epidiolex in Schedule V for Controlled Substances

II. FACTS: Controlled substances are governed by the S.C. Controlled Substances Act (CSA), found at Title 44, Chapter 53, of the S.C. Code of Laws. Schedule I substances are listed in S.C. Code Ann. Section 44-53-190. Pursuant to Section 44-53-160, titled "Manner in which changes in schedule of controlled substances shall be made," controlled substances are generally designated by the General Assembly upon recommendation by DHEC. Section 44-53-160(C) provides a process by which DHEC can expeditiously designate a substance as a controlled substance if the federal government has so designated.

Section 44-53-160(C) states:

If a substance is added, deleted, or rescheduled as a controlled substance pursuant to federal law or regulation, the department shall, at the first regular or special meeting of the South Carolina Board of Health and Environmental Control within thirty days after publication in the federal register of the final order designating the substance as a controlled substance or rescheduling or deleting the substance, add, delete, or reschedule the substance in the appropriate schedule. The addition, deletion, or rescheduling of a substance by the department pursuant to this subsection has the full force of law unless overturned by the General Assembly. The addition, deletion, or rescheduling of a substance by the department pursuant to this subsection must be in substance identical with the order published in the federal register effecting the change in federal status of the substance. Upon the addition, deletion, or rescheduling of a substance, the department shall forward copies of the change to the Chairmen of the Medical Affairs Committee and the Judiciary Committee of the Senate, the Medical, Military, Public and Municipal Affairs Committee, and the Judiciary Committee of the House of Representatives, and to the Clerks of the Senate and House, and shall post the schedules on the department's website indicating the change and specifying the effective date of the change.

With the issuance of this final order, the Acting Administrator of the Drug Enforcement Administration places certain drug products that have been approved by the Food and Drug Administration (FDA) and which contain cannabidiol (CBD) in schedule V of the Controlled Substances Act (CSA). Specifically, this order places FDA-approved drugs that contain CBD derived from cannabis and no more than 0.1 percent tetrahydrocannabinols in schedule V. This action is required to satisfy the responsibility of the Acting Administrator under the CSA to place a drug in the schedule he deems most appropriate to carry out United States obligations under the Single Convention on Narcotic Drugs, 1954. Also consistent therewith, DEA is adding such drugs to the list of substances that may only be imported or exported pursuant to a permit. The federal final order became effective September 28, 2018  
<https://www.gpo.gov/fdsys/pkg/FR-2018-09-28/pdf/2018-21121.pdf>



### III. ANALYSIS:

The United States is a party to the Single Convention on Narcotic Drugs, 1961 (Single Convention), and other international conventions designed to establish effective control over international and domestic traffic in controlled substances. The enactment and enforcement of the Controlled Substances Act (CSA) are the primary means by which the United States carries out its obligations under the Single Convention. On June 25, 2018, the Food and Drug Administration (FDA) announced that it approved a drug that is subject to control under the Single Convention. Specifically, the FDA announced that it approved the drug Epidiolex for the treatment of seizures associated with two rare and severe forms of epilepsy, Lennox-Gastaut syndrome and Dravet syndrome, in patients two years of age and older.

Epidiolex is an oral solution that contains cannabidiol (CBD) extracted from the cannabis plant. This is the first FDA-approved drug made from the cannabis plant. Now that Epidiolex has been approved by the FDA, it has a currently accepted medical use in treatment in the United States for purposes of the CSA. Accordingly, Epidiolex no longer meet the criteria for placement in schedule I of the CSA. DEA must therefore take the appropriate scheduling action to remove the drug from schedule I. The Single Convention obligates parties to require a permit for the importation and exportation of drugs listed in Schedule I of the Convention. This permit requirement applies to a drug product containing CBD extracted from the cannabis plant because such a product is a Schedule I drug under the Single Convention. However, under the CSA and DEA regulations, the import/export permit requirement does not apply to all controlled substances. Rather, a permit is required to import or export any controlled substance in schedule I and II as well as certain controlled substances in schedules III, IV, and V. At present, the cannabis used to make Epidiolex is grown in the United Kingdom and the drug is imported into the United States in finished dosage form.

In response to a request from the DEA, The Department of Health and Human Services (HHS) advised DEA that it found the Epidiolex formulation to have a very low potential for abuse and, therefore, recommended that, if DEA concluded that control of the drug was required under the Single Convention, Epidiolex should be placed in schedule V of the CSA. Until now, since the Epidiolex formulation had been a schedule I controlled substance, the importation of the drug from its foreign production facility has always been subject to the permit requirement. To ensure this requirement remains in place (and thus to prevent any lapse in compliance with the requirements of the Single Convention), this order will amend the DEA regulations to add the Epidiolex formulation to the list of nonnarcotic schedule III through V controlled substances that are subject to the import and export permit requirement.

By virtue of this order, Epidiolex (and any generic versions of the same formulation that might be approved by the FDA in the future) will be a schedule V controlled substance. Thus, all persons in the distribution chain who handle Epidiolex in the United States (importers, manufacturers, distributors, and practitioners) must comply with the requirements of the CSA and DEA regulations relating to schedule V controlled substances.

When determining whether a substance should be placed into Schedule V of the S.C. Controlled Substances Act, Section 44-53-260 of the S.C. Code of Laws requires the Department place a substance in Schedule V if it meets the following criteria:

- (a) It has a low potential for abuse relative to the substances listed in Schedule IV;
- (b) It has a currently accepted medical use in treatment in the United States; and
- (c) Abuse of the substance may lead to limited physical dependence or psychological dependence relative to the substances listed in Schedule IV.

IV. RECOMMENDATION:

As the Acting Administrator of the Drug Enforcement Administration has determined it necessary to most appropriately carry out United States Obligations under the Single Convention on Narcotic Drugs, 1961, by placing Epidiolex in Schedule V of the CSA, the Department recommends the Board adopt the scheduling of Epidiolex into Schedule V for Controlled Substances as set forth below and amend SC Code Section 44-53-270 to include:

Approved cannabidiol drugs. (1) A drug product in finished dosage formulation that has been approved by the U.S. Food and Drug Administration that contains cannabidiol (2-[1R-3-methyl-6R-(1-methylethenyl)-2-cyclohexen-1-yl]-5-pentyl-1,3- benzenediol) derived from cannabis and no more than 0.1 percent (w/w) residual tetrahydrocannabinols

Submitted by:



Lisa Thomson  
Chief, Bureau of Drug Control



Shelly Kelly  
Deputy Director of Health Regulations

Attachments: Federal Register Vol. 83, No. 189, Friday, September 28, 2018

Dated: September 24, 2018.  
**Leslie Kux,**  
*Associate Commissioner for Policy.*  
 [FR Doc. 2018–21146 Filed 9–27–18; 8:45 am]  
**BILLING CODE 4164–01–P**

**DEPARTMENT OF HEALTH AND HUMAN SERVICES**

**Food and Drug Administration**

**21 CFR Parts 520, 522, 524, and 558**

[Docket No. FDA–2018–N–0002]

**New Animal Drugs; Withdrawal of Approval of New Animal Drug Applications**

**AGENCY:** Food and Drug Administration, HHS.

**ACTION:** Notification of withdrawal.

**SUMMARY:** The Food and Drug Administration (FDA) is withdrawing approval of 12 new animal drug applications (NADAs) at the sponsor's request because these products are no longer manufactured or marketed.

**DATES:** Withdrawal of approval is effective October 9, 2018.

**FOR FURTHER INFORMATION CONTACT:** Sujaya Dessai, Center for Veterinary Medicine (HFV–212), Food and Drug Administration, 7519 Standish Pl., Rockville, MD 20855, 240–402–5761, [sujaya.dessai@fda.hhs.gov](mailto:sujaya.dessai@fda.hhs.gov).

**SUPPLEMENTARY INFORMATION:** Virbac AH, Inc., 3200 Meacham Blvd., Ft. Worth, TX 76137, has requested that FDA withdraw approval of the NADAs listed in the following table because the products are no longer manufactured or marketed:

File No.	Product name	21 CFR section
011–779 ...	PURINA PIGEMIA 100 (colloidal ferric oxide).	522.1182
040–205 ...	PURINA Horse Wormer Medicated (thiabendazole).	520.2380a
042–116 ...	PURINA 6 DAY WORM-KILL Feed Premix (coumaphos).	558.185
043–215 ...	PURINA GRUB-KILL Pour-on Cattle Insecticide (famphur).	524.900
046–700 ...	STATYL Medicated Premix (nequinatene).	558.365
091–260 ...	PULVEX WORM CAPS (piperazine phosphate monohydrate).	520.1804
097–258 ...	PURINA BAN-WORM for Pigs (pyrantel tartrate).	558.485
102–942 ...	PULVEX Multipurpose Worm Caps (dichlorophene, toluene).	520.580
113–748 ...	PURINA PIGEMIA Oral (iron dextran complex).	520.1182
135–941 ...	CHECK-R-TON BM (pyrantel tartrate).	558.485

File No.	Product name	21 CFR section
136–116 ...	PURINA WORM-A-REST™ Litter Pack Premix (fenbendazole).	520.905d
140–869 ...	PURINA SAF-T-BLOCK BG Medicated Feed Block (poloxalene, 6.6%).	520.1840

Therefore, under authority delegated to the Commissioner of Food and Drugs, and in accordance with § 514.116 *Notice of withdrawal of approval of application* (21 CFR 514.116), notice is given that approval of NADAs 011–779, 040–205, 042–116, 043–215, 046–700, 091–260, 097–258, 102–942, 113–748, 135–941, 136–116, and 140–869, and all supplements and amendments thereto, is hereby withdrawn, effective October 9, 2018.

Elsewhere in this issue of the **Federal Register**, FDA is amending the animal drug regulations to reflect the voluntary withdrawal of approval of these applications.

Dated: September 24, 2018.  
**Leslie Kux,**  
*Associate Commissioner for Policy.*  
 [FR Doc. 2018–21147 Filed 9–27–18; 8:45 am]  
**BILLING CODE 4164–01–P**

**DEPARTMENT OF JUSTICE**

**Drug Enforcement Administration**

**21 CFR Parts 1308, 1312**

[Docket No. DEA–486]

**Schedules of Controlled Substances: Placement in Schedule V of Certain FDA-Approved Drugs Containing Cannabidiol; Corresponding Change to Permit Requirements**

**AGENCY:** Drug Enforcement Administration, Department of Justice.

**ACTION:** Final order.

**SUMMARY:** With the issuance of this final order, the Acting Administrator of the Drug Enforcement Administration places certain drug products that have been approved by the Food and Drug Administration (FDA) and which contain cannabidiol (CBD) in schedule V of the Controlled Substances Act (CSA). Specifically, this order places FDA-approved drugs that contain CBD derived from cannabis and no more than 0.1 percent tetrahydrocannabinols in schedule V. This action is required to satisfy the responsibility of the Acting Administrator under the CSA to place a drug in the schedule he deems most appropriate to carry out United States obligations under the Single Convention

on Narcotic Drugs, 1961. Also consistent therewith, DEA is adding such drugs to the list of substances that may only be imported or exported pursuant to a permit.

**DATES:** Effective September 28, 2018.

**FOR FURTHER INFORMATION CONTACT:** Kathy L. Federico, Regulatory Drafting and Policy Support Section (DPW), Diversion Control Division, Drug Enforcement Administration; Mailing Address: 8701 Morrisette Drive, Springfield, Virginia 22152; Telephone: (202) 598–6812.

**SUPPLEMENTARY INFORMATION:**

**Background and Legal Authority**

The United States is a party to the Single Convention on Narcotic Drugs, 1961 (Single Convention), and other international conventions designed to establish effective control over international and domestic traffic in controlled substances. 21 U.S.C. 801(7). The Single Convention entered into force for the United States on June 24, 1967, after the Senate gave its advice and consent to the United States' accession. *See* Single Convention, 18 U.S.T. 1407. The enactment and enforcement of the Controlled Substances Act (CSA) are the primary means by which the United States carries out its obligations under the Single Convention.<sup>1</sup> Various provisions of the CSA directly reference the Single Convention. One such provision is 21 U.S.C. 811(d)(1), which relates to scheduling of controlled substances.

As stated in subsection 811(d)(1), if control of a substance is required “by United States obligations under international treaties, conventions, or protocols in effect on October 27, 1970, the Attorney General shall issue an order controlling such drug under the schedule he deems most appropriate to carry out such obligations, without regard to the findings required by [subsections 811(a) or 812(b)] and without regard to the procedures prescribed by [subsections 811(a) and (b)].” This provision is consistent with the Supremacy Clause of the U.S. Constitution (art. VI, sec. 2), which provides that all treaties made under the authority of the United States “shall be the supreme Law of the Land.” In accordance with this constitutional

<sup>1</sup> *See* S. Rep. No. 91–613, at 4 (1969) (“The United States has international commitments to help control the worldwide drug traffic. To honor those commitments, principally those established by the Single Convention on Narcotic Drugs of 1961, is clearly a Federal responsibility.”); *Control of Papaver Bracteatum*, 1 Op. O.L.C. 93, 95 (1977) (“[A] number of the provisions of [the CSA] reflect Congress’ intent to comply with the obligations imposed by the Single Convention.”).

mandate, under section 811(d)(1), Congress directed the Attorney General (and the Administrator of DEA, by delegation)<sup>2</sup> to ensure that compliance by the United States with our nation's obligations under the Single Convention is given top consideration when it comes to scheduling determinations.

Section 811(d)(1) is relevant here because, on June 25, 2018, the Food and Drug Administration (FDA) announced that it approved a drug that is subject to control under the Single Convention. Specifically, the FDA announced that it approved the drug Epidiolex for the treatment of seizures associated with two rare and severe forms of epilepsy, Lennox-Gastaut syndrome and Dravet syndrome, in patients two years of age and older. [www.fda.gov/NewsEvents/Newsroom/PressAnnouncements/ucm611046.htm](http://www.fda.gov/NewsEvents/Newsroom/PressAnnouncements/ucm611046.htm). Epidiolex is an oral solution that contains cannabidiol (CBD) extracted from the cannabis plant. This is the first FDA-approved drug made from the cannabis plant.<sup>3</sup> Now that Epidiolex has been approved by the FDA, it has a currently accepted medical use in treatment in the United States for purposes of the CSA. Accordingly, Epidiolex no longer meets the criteria for placement in schedule I of the CSA. See 21 U.S.C. 812(b) (indicating that while substances in schedule I have no currently accepted medical use in treatment in the United States, substances in schedules II–V do); see also *United States v. Oakland Cannabis Buyers' Cooperative*, 532 U.S. 483, 491–92 (2001) (same). DEA must therefore take the appropriate scheduling action to remove the drug from schedule I.

In making this scheduling determination, as section 811(d)(1) indicates, it is necessary to assess the relevant requirements of the Single Convention. Under the treaty, cannabis, cannabis resin, and extracts and tinctures of cannabis are listed in Schedule I.<sup>4</sup> The cannabis plant

contains more than 100 cannabinoids. Among these are tetrahydrocannabinols (THC) and CBD.<sup>5</sup> Material that contains THC and CBD extracted from the cannabis plant falls within the listing of extracts and tinctures of cannabis for purposes of the Single Convention.<sup>6</sup> Thus, such material, which includes, among other things, a drug product containing CBD extracted from the cannabis plant, is a Schedule I drug under the Single Convention.

Parties to the Single Convention are required to impose a number of control measures with regard to drugs listed in Schedule I of the Convention. These include, but are not limited to, the following:

- Limiting exclusively to medical and scientific purposes the production, manufacture, export, import, distribution of, trade in, use and possession of such drugs. Article 4.
- Furnishing to the International Narcotics Control Board (INCB) annual estimates of, among other things, quantities of such drugs to be consumed for medical and scientific purposes, utilized for the manufacture of other drugs, and held in stock. Article 19.
- Furnishing to the INCB statistical returns on the actual production, utilization, consumption, imports and exports, seizures, and stocks of such drugs during the prior year. Article 20.
- Requiring that licensed manufacturers of such drugs obtain quotas specifying the amounts of such drugs they may manufacture to prevent excessive production and accumulation beyond that necessary to satisfy legitimate needs. Article 29.
- Requiring manufacturers and distributors of such drugs to be licensed. Articles 29 & 30.
- Requiring medical prescriptions for the dispensing of such drugs to patients. Article 30.
- Requiring importers and exporters of such drugs to be licensed and requiring each individual importation or exportation to be predicated on the issuance of a permit. Article 31.

cannabis resin are among the drugs listed in Schedule IV of the Single Convention.

<sup>5</sup> There are numerous isomers of cannabidiol, which will be referred to here collectively as "CBD."

<sup>6</sup> Although the Single Convention does not define the term "extract," the ordinary meaning of that term would include a product, such as a concentrate of a certain chemical or chemicals, obtained by a physical or chemical process. See, e.g., Webster's Third New International Dictionary 806 (1976). Thus, the term extract of cannabis would include any product that is made by subjecting cannabis material to a physical or chemical process designed to isolate or increase the concentration of one or more of the cannabinoid constituents.

• Prohibiting the possession of such drugs except under legal authority. Article 33.

• Requiring those in the legitimate distribution chain (manufacturers, distributors, scientists, and those who lawfully dispense such drugs) to keep records that show the quantities of such drugs manufactured, distributed, dispensed, acquired, or otherwise disposed of during the prior two years. Article 34.

Because the CSA was enacted in large part to satisfy United States obligations under the Single Convention, many of the CSA's provisions directly implement the foregoing treaty requirements. None of the foregoing obligations of the United States could be satisfied for a given drug if that drug were removed entirely from the CSA schedules. At least one of the foregoing requirements (quotas) can only be satisfied if the drug that is listed in Schedule I of the Single Convention is also listed in schedule I or II of the CSA because, as 21 U.S.C. 826 indicates, the quota requirements generally apply only to schedule I and II controlled substances.

The permit requirement warrants additional explanation. As indicated above, the Single Convention obligates parties to require a permit for the importation and exportation of drugs listed in Schedule I of the Convention. This permit requirement applies to a drug product containing CBD extracted from the cannabis plant because, as further indicated above, such a product is a Schedule I drug under the Single Convention. However, under the CSA<sup>7</sup> and DEA regulations, the import/export permit requirement does not apply to all controlled substances. Rather, a permit is required to import or export any controlled substance in schedule I and II as well as certain controlled substances in schedules III, IV, and V. See 21 U.S.C. 952 and 953; 21 CFR 1312.11, 1312.12, 1312.21, 1312.22. Thus, in deciding what schedule is most appropriate to carry out the United States' obligations under the Single Convention with respect to the importation and exportation of Epidiolex, I conclude there are two options:

(i) Control the drug in schedule II, which will automatically require an

<sup>7</sup> The provisions of federal law relating to the import and export of controlled substances—those found in 21 U.S.C. 951 through 971—are more precisely referred to as the Controlled Substances Import and Export Act (CSIEA). However, federal courts and DEA often use the term "CSA" to refer collectively to all provisions from 21 U.S.C. 801 through 971 and, for ease of exposition, this document will do likewise.

<sup>2</sup> 28 CFR 0.100.

<sup>3</sup> The drug Marinol was approved by the FDA in 1985. Marinol contains a synthetic form of dronabinol (an isomer of tetrahydrocannabinol) and thus is not made from the cannabis plant.

<sup>4</sup> The text of the Single Convention capitalizes schedules (e.g., "Schedule I"). In contrast, the text of the CSA generally refers to schedules in lower case. This document will follow this approach of using capitalization or lower case depending on whether the schedule is under the Single Convention or the CSA.

It should also be noted that the schedules of the Single Convention operate somewhat differently than the schedules of the CSA. Unlike the CSA, the Single Convention imposes additional restrictions on drugs listed in Schedule IV that go beyond those applicable to drugs listed in Schedule I. All drugs in Schedule IV of the Single Convention are also in Schedule I of the Convention. Cannabis and

import/export permit under existing provisions of the CSA and DEA regulations or

(ii) control the drug in schedule III, IV, or V, and simultaneously amend the regulations to require a permit to import or export Epidiolex.

It bears emphasis that where, as here, control of a drug is required by the Single Convention, the DEA Administrator “shall issue an order controlling such drug under the schedule he deems most appropriate to carry out such obligations, *without regard to the findings required by [21 U.S.C. 811 (a) or 812(b)] and without regard to the procedures prescribed by [21 U.S.C. 811 (a) or (b)].*” 21 U.S.C. 811(d)(1) (emphasis added). Thus, in such circumstances, the Administrator is not obligated to request a medical and scientific evaluation or scheduling recommendation from the Department of Health and Human Services (HHS) (as is normally done pursuant to section 811(b)).<sup>8</sup> Nonetheless, DEA did seek such an evaluation and recommendation from HHS with respect to the Epidiolex formulation. In responding to that request, HHS advised DEA that it found the Epidiolex formulation to have a very low potential for abuse and, therefore, recommended that, if DEA concluded that control of the drug was required under the Single Convention, Epidiolex should be placed in schedule V of the CSA.<sup>9</sup> Although I am not required to consider this HHS recommendation when issuing an order under section 811(d)(1), because I believe there are two legally viable scheduling options (listed above), both of which would satisfy the United States’ obligations under the Single Convention, I will exercise my discretion and choose the option that most closely aligns to the HHS recommendation. Namely, I am hereby ordering that the Epidiolex formulation (and any future FDA-approved generic

versions of such formulation made from cannabis) be placed in schedule V of the CSA.

As noted, this order placing the Epidiolex formulation in schedule V will only comport with section 811(d)(1) if all importations and exportations of the drug remain subject to the permit requirement. Until now, since the Epidiolex formulation had been a schedule I controlled substance, the importation of the drug from its foreign production facility has always been subject to the permit requirement. To ensure this requirement remains in place (and thus to prevent any lapse in compliance with the requirements of the Single Convention), this order will amend the DEA regulations (21 CFR 1312.30) to add the Epidiolex formulation to the list of nonnarcotic schedule III through V controlled substances that are subject to the import and export permit requirement.

Finally, a brief explanation is warranted regarding the quota requirement in connection with the Single Convention. As indicated above, for drugs listed in Schedule I of the Convention, parties are obligated to require that licensed manufacturers of such drugs obtain quotas specifying the amounts of such drugs they may manufacture. The purpose of this treaty requirement is to prevent excessive production and accumulation beyond that necessary to satisfy legitimate needs. Under this scheduling order, the United States will continue to meet this obligation because the bulk cannabis material used to make the Epidiolex formulation (as opposed to the FDA-approved drug product in finished dosage form) will remain in schedule I of the CSA and thus be subject to all applicable quota provisions under 21 U.S.C. 826.<sup>10</sup>

#### Requirements for Handling FDA-Approved Products Containing CBD

As noted, until now, Epidiolex has been a schedule I controlled substance. By virtue of this order, Epidiolex (and any generic versions of the same formulation that might be approved by the FDA in the future) will be a schedule V controlled substance. Thus, all persons in the distribution chain who handle Epidiolex in the United States (importers, manufacturers, distributors, and practitioners) must comply with the requirements of the CSA and DEA regulations relating to schedule V controlled substances. As

further indicated, any material, compound, mixture, or preparation *other than Epidiolex* that falls within the CSA definition of marijuana set forth in 21 U.S.C. 802(16), including any non-FDA-approved CBD extract that falls within such definition, remains a schedule I controlled substance under the CSA.<sup>11</sup> Thus, persons who handle such items will continue to be subject to the requirements of the CSA and DEA regulations relating to schedule I controlled substances.

#### Regulatory Analyses

##### *Administrative Procedure Act*

The CSA provides for an expedited scheduling action where control of a drug is required by the United States’ obligations under the Single Convention. 21 U.S.C. 811(d)(1). Under such circumstances, the Attorney General must “issue an *order* controlling such drug under the schedule he deems most appropriate to carry out such obligations,” without regard to the findings or procedures otherwise required for scheduling actions. *Id.* (emphasis added). Thus, section 811(d)(1) expressly requires that this type of scheduling action not proceed through the notice-and-comment rulemaking procedures governed by the Administrative Procedure Act (APA), which generally apply to scheduling actions; it instead requires that such scheduling action occur through the issuance of an “order.”

Although the text of section 811(d)(1) thus overrides the normal APA considerations, it is notable that the APA itself contains a provision that would have a similar effect. As set forth in 21 U.S.C. 553(a)(1), the section of the APA governing rulemaking does not apply to a “foreign affairs function of the United States.” An order issued under section 811(d)(1) may be considered a foreign affairs function of the United States because it is for the express purpose of ensuring that the

<sup>8</sup> In the House Report to the bill that would become the CSA (H. Rep. No. 91-1444, at 36 (1970)), this issue is explained as follows:

Under subsection [811(d)], where control of a drug or other substance by the United States is required by reason of its obligations under [the Single Convention], the bill does not require that the Attorney General seek an evaluation and recommendation by the Secretary of Health, Education, and Welfare, or pursue the procedures for control prescribed by the bill but he may include the drug or other substance under any of the five schedules of the bill which he considers most appropriate to carry out the obligations of the United States under the international instrument, and he may do so without making the specific findings otherwise required for inclusion of a drug or other substance in that schedule.

<sup>9</sup> HHS most recently updated its medical and scientific evaluation and scheduling recommendation for the Epidiolex formulation by letter to DEA dated June 13, 2018.

<sup>10</sup> At present, the cannabis used to make Epidiolex is grown in the United Kingdom and the drug is imported into the United States in finished dosage form.

<sup>11</sup> Nothing in this order alters the requirements of the Federal Food, Drug, and Cosmetic Act that might apply to products containing CBD. In announcing its recent approval of Epidiolex, the FDA Commissioner stated:

[W]e remain concerned about the proliferation and illegal marketing of unapproved CBD-containing products with unproven medical claims. . . . The FDA has taken recent actions against companies distributing unapproved CBD products. These products have been marketed in a variety of formulations, such as oil drops, capsules, syrups, teas, and topical lotions and creams. These companies have claimed that various CBD products could be used to treat or cure serious diseases such as cancer with no scientific evidence to support such claims.

[www.fda.gov/NewsEvents/Newsroom/PressAnnouncements/ucm611047.htm](http://www.fda.gov/NewsEvents/Newsroom/PressAnnouncements/ucm611047.htm).

United States carries out its obligations under an international treaty.

*Executive Order 12866, 13563, and 13771, Regulatory Planning and Review, Improving Regulation and Regulatory Review, and Reducing Regulation and Controlling Regulatory Costs*

This action is not a significant regulatory action as defined by Executive Order 12866 (Regulatory Planning and Review), section 3(f), and the principles reaffirmed in Executive Order 13563 (Improving Regulation and Regulatory Review), and, accordingly, this action has not been reviewed by the Office of Management and Budget (OMB).

This order is not an Executive Order 13771 regulatory action.

*Executive Order 12988, Civil Justice Reform*

This action meets the applicable standards set forth in sections 3(a) and 3(b)(2) of Executive Order 12988 to eliminate drafting errors and ambiguity, minimize litigation, provide a clear legal standard for affected conduct, and promote simplification and burden reduction.

*Executive Order 13132, Federalism*

This action does not have federalism implications warranting the application of Executive Order 13132. This action does not have substantial direct effects on the States, on the relationship between the national government and the States, or on the distribution of power and responsibilities among the various levels of government.

*Executive Order 13175, Consultation and Coordination With Indian Tribal Governments*

This action does not have tribal implications warranting the application of Executive Order 13175. The action does not have substantial direct effects on one or more Indian tribes, on the relationship between the Federal government and Indian tribes, or on the distribution of power and responsibilities between the Federal government and Indian tribes.

*Regulatory Flexibility Act*

The Regulatory Flexibility Act (RFA) (5 U.S.C. 601–612) applies to rules that are subject to notice and comment under section 553(b) of the APA or any other law. As explained above, the CSA exempts this order from the APA notice-and-comment rulemaking provisions. Consequently, the RFA does not apply to this action.

*Paperwork Reduction Act of 1995*

This action does not impose a new collection of information requirement under the Paperwork Reduction Act of 1995. 44 U.S.C. 3501–3521. An agency may not conduct or sponsor, and a person is not required to respond to, a collection of information unless it displays a currently valid OMB control number.

*Congressional Review Act*

As noted above, this action is an order, not a rulemaking. Accordingly, the Congressional Review Act (CRA) is inapplicable, as it applies only to rules. However, the DEA has submitted a copy of this final order to both Houses of Congress and to the Comptroller General, although such filing is not required under the Small Business Regulatory Enforcement Fairness Act of 1996 (CRA), 5 U.S.C. 801–808.

**List of Subjects**

21 CFR Part 1308

Administrative practice and procedure, Drug traffic control, Reporting and recordkeeping requirements.

21 CFR Part 1312

Administrative practice and procedure, Drug traffic control, Exports, Imports, Reporting requirements.

For the reasons set out above, DEA amends 21 CFR parts 1308 and 1312 as follows:

**PART 1308—SCHEDULES OF CONTROLLED SUBSTANCES**

■ 1. The authority citation for part 1308 continues to read as follows:

**Authority:** 21 U.S.C. 811, 812, 871(b), 956(b) unless otherwise noted.

■ 2. In § 1308.15, add paragraph (f) to read as follows:

**§ 1308.15 Schedule V.**

\* \* \* \* \*

(f) *Approved cannabidiol drugs.* (1) A drug product in finished dosage formulation that has been approved by the U.S. Food and Drug Administration that contains cannabidiol (2-[1R-3-methyl-6R-(1-methylethylene)-2-cyclohexen-1-yl]-5-pentyl-1,3-benzenediol) derived from cannabis and no more than 0.1 percent (w/w) residual tetrahydrocannabinols ..... 7367

(2) [Reserved]  
\* \* \* \* \*

**PART 1312—IMPORTATION AND EXPORTATION OF CONTROLLED SUBSTANCES**

■ 3. The authority citation for part 1312 is revised to read as follows:

**Authority:** 21 U.S.C. 821, 871(b), 952, 953, 954, 957, 958.

■ 4. In § 1312.30, revise the introductory text and add paragraph (b) to read as follows:

**§ 1312.30 Schedule III, IV, and V non-narcotic controlled substances requiring an import and export permit.**

The following Schedule III, IV, and V non-narcotic controlled substances have been specifically designated by the Administrator of the Drug Enforcement Administration as requiring import and export permits pursuant to sections 201(d)(1), 1002(b)(2), and 1003(e)(3) of the Act (21 U.S.C. 811(d)(1), 952(b)(2), and 953(e)(3)):

\* \* \* \* \*

(b) A drug product in finished dosage formulation that has been approved by the U.S. Food and Drug Administration that contains cannabidiol (2-[1R-3-methyl-6R-(1-methylethylene)-2-cyclohexen-1-yl]-5-pentyl-1,3-benzenediol) derived from cannabis and no more than 0.1 percent (w/w) residual tetrahydrocannabinols.

Dated: September 21, 2018.

**Uttam Dhillon,**

*Acting Administrator.*

[FR Doc. 2018–21121 Filed 9–27–18; 8:45 am]

**BILLING CODE 4410–09–P**

**DEPARTMENT OF HOMELAND SECURITY**

**Coast Guard**

**33 CFR Part 100**

[Docket No. USCG–2018–0795]

**Special Local Regulations for Marine Events; San Francisco Bay Navy Fleet Week Parade of Ships and Blue Angels Demonstration, San Francisco, CA**

**AGENCY:** Coast Guard, DHS.

**ACTION:** Notice of enforcement of regulation.

**SUMMARY:** The Coast Guard will enforce the special local regulations in the navigable waters of the San Francisco Bay for the San Francisco Bay Navy Fleet Week Parade of Ships and Blue Angels Demonstration from October 4 through October 7, 2018. This action is necessary to ensure the safety of event participants and spectators. During the enforcement period, unauthorized

(x) ACTION/DECISION  
( ) INFORMATION

Date: October 11, 2018

To: S.C. Board of Health and Environmental Control

From: Bureau of Water

**Re: Notice of Proposed Regulation for Repealing Regulation 61-67.1, Requirements for State Water Pollution Control Revolving Fund Loan Assistance.**

## I. Introduction

The Bureau of Water (“Bureau”) proposes the attached Notice of Proposed Regulation repealing R. 61-67.1, *Requirements for State Water Pollution Control Revolving Fund Loan Assistance*, on the October 26, 2018, *South Carolina State Register* (S.C. Code Section 48-6-10 *et seq.*) which the General Assembly repealed in 1992 and replaced with S.C. Code Section 48-5-10 *et seq.* The Administrative Procedures Act, S.C. Code Section 1-23-120(A), requires General Assembly review of this repeal.

## II. Facts

1. The Bureau proposes repeal of R.61-67.1. The regulation describes the process the Department of Health and Environmental Control (“Department”) and the former South Carolina Budget and Control Board followed in administering the State Water Pollution Revolving Fund received in federal grants from the Environmental Protection Agency (“EPA”). In 1992, the General Assembly repealed S.C. Code Section 48-6-10 *et seq.* and replaced it with the South Carolina Water Quality Revolving Fund Authority Act (S.C. Code Section 48-5-10 *et seq.*). Passage of the South Carolina Water Quality Revolving Fund Authority Act (“Act”) has rendered R.61-67.1 obsolete. The Act provides authority for the Department and the South Carolina Water Quality Revolving Fund Authority to administer the South Carolina clean water and drinking water revolving funds and federal grants received as supplements to the revolving funds from the EPA. The South Carolina Water Quality Revolving Fund Authority comprises the members of the State Fiscal Accountability Authority, with administrative and implementation support from the South Carolina Rural Infrastructure Authority (“RIA”).

2. In accordance with the Act, the State Water Pollution Revolving Fund (“SRF”) authorized under the former statute (Title 48, Chapter 6) remains in existence and is now referred to as the Clean Water State Revolving Fund (“CWSRF”). The CWSRF, like the former State Water Pollution Revolving Fund, provides low interest loans to public utilities and local governments for wastewater and stormwater infrastructure projects. The General Assembly amended Title 48, Chapter 5 in 1997 to include the Drinking Water State Revolving Fund (“DWSRF”), which provides low interest loans to public utilities and local governments for public drinking water infrastructure projects. The 1987 amendments to the Federal Water Pollution Act, otherwise known as the Clean Water Act, authorized federal funding for the CWSRF and the former State Water Pollution Revolving Fund. The 1996 amendments to the Safe Drinking Water Act authorized federal funding for the DWSRF. The CWSRF and DWSRF are revolving funds because they receive repayments and interest from the loans made from the funds. Additional money comes into the funds through interest on investments and annual federal grants received from EPA. Repeal of the regulation will have no impact or implications for the current administration and implementation of the CWSRF or DWSRF.

3. The Department does not propose replacing this regulation with a new regulation. The RIA are able to effectively administer and implement the SRF program using the state statute, Chapter 5, and federal laws, regulations, and grant requirements that govern the use of the existing state laws and regulations also are used to implement the program such as environmental regulations that govern the design and construction of wastewater and drinking water projects.

4. The Department had a Notice of Drafting published in the June 22, 2018, issue of the South Carolina Register. The Notice of Drafting appears herein as Attachment 1 above. RIA is the Department's partner agency in administering the SRF program. The Department is responsible for obtaining EPA grants, evaluating technical aspects of SRF projects, and issuing construction permits for SRF projects. RIA is responsible for the financial aspects of the SRF program, including loan policies, loan applications and loan agreements, disbursements, and loan administration activities including payments. RIA participated in the development of the Notice of Drafting for the repeal of Section 67.1. The Department received no public comments on the Notice of Drafting.

5. The Bureau sent the Notice of Drafting directly to four organizations in the state that regulate utilities and local governments requesting comments on the proposed repeal. These organizations were selected because they are eligible to receive funding for wastewater, stormwater, and drinking water infrastructure projects through the CWSRF and DWSRF. The organizations contacted include the Municipal Association of South Carolina, South Carolina Rural Water Association, South Carolina Water Quality Association, and South Carolina Section of the American Water Works Association. All organizations responded, and the responses ranged from support for the repeal to no objection to the repeal.

6. The Department contacted the State Treasurer and the Comptroller General regarding the repeal of 67.1, as both agencies have specific responsibilities mandated by the constitution to support the repeal of the regulation.

7. Appropriate Department staff conducted an internal review of the proposed repeal on August 26, 2018.

### Request for Approval

The Bureau respectfully requests the Board to grant approval of the attached Notice of Proposed Regulation for publication in the October 26, 2018, issue of the South Carolina Register.

  
Mike Marcus  
Chief  
Bureau of Water

 CZ-  
Mike Marcus  
Director  
Environmental Affairs

**Attachments:**

- A. Notice of Proposed Regulation
- B. Notice of Drafting published in the June 22, 2018, issue of the South Carolina Register



## ATTACHMENT A

### STATE REGISTER NOTICE OF PROPOSED REGULATION FOR REGULATION 61-67.1, REQUIREMENTS FOR STATE WATER POLLUTION CONTROL REVOLVING FUND LOAN ASSISTANCE

October 11, 2018

Document No. \_\_\_\_\_

#### DEPARTMENT OF HEALTH AND ENVIRONMENTAL CONTROL CHAPTER 61

Statutory Authority: 1976 Code Section(s) 48-5-10 et seq.

61-67.1. Requirements for State Water Pollution Control Revolving Fund Loan Assistance.

#### Preamble

The Department of Health and Environmental Control (“Department”) proposes repeal of R.61-67.1. The regulation describes the process the Department and the former South Carolina Budget and Control Board followed in administering the State Water Pollution Revolving Fund received in federal grants from the Environmental Protection Agency (“EPA”). In 1992, the General Assembly repealed S.C. Code Section 48-6-10 *et seq.* and replaced it with the South Carolina Water Quality Revolving Fund Authority Act (S.C. Code Section 48-5-10 *et seq.* Passage of the South Carolina Water Quality Revolving Fund Authority Act (“Act”) has rendered R.61-67.1 obsolete. The Act provides authority for the Department and the South Carolina Water Quality Revolving Fund Authority to administer the South Carolina clean water and drinking water revolving funds program and federal grants received as supplements to the revolving funds from the EPA. The South Carolina Water Quality Revolving Fund Authority comprises the members of the State Fiscal Accountability Authority, with administrative and implementation support from the South Carolina Rural Infrastructure Authority (“RIA”).

Repeal of the regulation will have no impact or implications for the current administration and implementation of the South Carolina Clean Water State Revolving Fund (“CWSRF”). The CWSRF, like its predecessor, the State Water Pollution Revolving Fund under the repealed Title 48, Chapter 6, provides low interest loans to public utilities and local governments for wastewater and stormwater infrastructure projects. The Department and RIA are able to effectively administer and implement the state revolving funds program using the state statute, Title 48, Chapter 5, and federal laws, regulations, and grant requirements that govern the use of the funds. Other existing state laws and regulations also are used to implement the program such as environmental permitting regulations that govern the design and construction of wastewater and drinking water infrastructure projects.

The Administrative Procedures Act, S.C. Code Section 1-23-120(A), requires General Assembly review of this repeal.

The Department had a Notice of Drafting published in the June 22, 2018, South Carolina State Register.

#### Section-by-Section Discussion of Proposed Repeal:

Regulation 61-67.1 will be repealed in its entirety as it is obsolete due to repeal of the original authorizing statute (Title 48, Chapter 6 of the South Carolina Code). Please see the Statement of Need and Reasonableness herein

## **Notice of Public Hearing and Opportunity for Public Comment:**

Interested persons may submit comment(s) on the proposed repeal to Charles Gorman of the Bureau of Water; S.C. Department of Health and Environmental Control, 2600 Bull Street, Columbia, S.C. 29201; [gormancm@dhec.sc.gov](mailto:gormancm@dhec.sc.gov). To be considered, the Department must receive the comment(s) by 5:00 p.m. on November 26, 2018, the close of the comment period.

The S.C. Board of Health and Environmental Control will conduct a public hearing on the proposed repeal during its December 13, 2018, 10:00 a.m. meeting. Interested persons may make oral and/or submit written comments at the public hearing. Persons making oral comments should limit their statements to five (5) minutes or less. The meeting will take place in the Board Room of the DHEC Building, located at 2600 Bull Street, Columbia, S.C. 29201. Due to admittance procedures, all visitors must enter through the main Bull Street entrance and register at the front desk. The Department will publish a meeting agenda twenty-four (24) hours in advance indicating the order of its scheduled items at: <http://www.scdhec.gov/Agency/docs/AGENDA.PDF>.

The Department publishes a Monthly Regulation Development Update tracking the status of its proposed new regulations, amendments, and repeals and providing links to associated State Register documents at <http://www.scdhec.gov/Agency/RegulationsAndUpdates/RegulationDevelopmentUpdate/>.

## **Preliminary Fiscal Impact Statement**

There are no anticipated new costs associated with the repeal of this regulation to the state or its political subdivisions.

## **Statement of Need and Reasonableness**

The following presents an analysis of the factors listed in 1976 Code Section 1-23-115(C)(1)-(3) and (9)-(11):

DESCRIPTION OF REGULATION: 61-67.1, Requirements for State Water Pollution Control Revolving Fund Loan Assistance

Purpose: The Department proposes repealing R.61-67.1, Requirements for State Water Pollution Control Revolving Fund Loan Assistance. This regulation is obsolete due to repeal of the original authorizing statute (Title 48, Chapter 6 of the South Carolina Code). In 1992, the General Assembly repealed Title 48, Chapter 6 and replaced it with the South Carolina Water Quality Revolving Fund Authority Act (Title 48, Chapter 5).

Legal Authority: 1976 Code Section(s) 48-5-10 et seq.

Plan for Implementation: The DHEC Regulation Development Update (accessible at <http://www.scdhec.gov/Agency/RegulationsAndUpdates/RegulationDevelopmentUpdate/>) provides a summary of and link to this proposed repeal. Additionally, printed copies are available for a fee from the Department's Freedom of Information Office. Upon taking legal effect, Department personnel will take appropriate steps to inform the regulated community of the repeal and any associated information.

## DETERMINATION OF NEED AND REASONABLENESS OF THE PROPOSED REGULATION BASED ON ALL FACTORS HEREIN AND EXPECTED BENEFITS:

In the interest of good government and efficiency, the Department proposes to repeal R.61-67.1, Requirements for State Water Pollution Control Revolving Fund Loan Assistance. The regulation describes the process the Department of Health and Environmental Control (“Department”) and the former South Carolina Budget and Control Board followed in administering the State Water Pollution Revolving Fund received in federal grants from the Environmental Protection Agency (“EPA”). In 1992, the General Assembly repealed S.C. Code Section 48-6-10 et seq. and replaced it with the South Carolina Water Quality Revolving Fund Authority Act (S.C. Code Section 48-5-10 et seq.). Passage of the South Carolina Water Quality Revolving Fund Authority Act (“Act”) has rendered R.61-67.1 obsolete. The Act provides authority for the Department and the South Carolina Water Quality Revolving Fund Authority to administer the South Carolina clean water and drinking water revolving funds program and federal grants received as supplements to the revolving funds from the EPA. The South Carolina Water Quality Revolving Fund Authority comprises the members of the State Fiscal Accountability Authority, with administrative and implementation support from the South Carolina Rural Infrastructure Authority (“RIA”).

In accordance with the Act, the State Water Pollution Revolving Fund (“SRF”) authorized under the former statute (Title 48, Chapter 6) remains in existence and is now referred to as the Clean Water State Revolving Fund (“CWSRF”). The CWSRF, like the former State Water Pollution Revolving Fund, provides low interest loans to public utilities and local governments for wastewater and stormwater infrastructure projects. The General Assembly amended Title 48, Chapter 5 in 1997 to include the Drinking Water State Revolving Fund (“DWSRF”), which provides low interest loans to public utilities and local governments for public drinking water infrastructure projects. The 1987 amendments to the Federal Water Pollution Act, otherwise known as the Clean Water Act, authorized federal funding for the CWSRF and the former State Water Pollution Revolving Fund. The 1996 amendments to the Safe Drinking Water Act authorized federal funding for the DWSRF. The CWSRF and DWSRF are revolving funds because they receive repayments and interest from the loans made from the funds. Additional money comes into the funds through interest on investments and annual federal grants received from EPA. Repeal of the regulation will have no impact or implications for the current administration and implementation of the CWSRF or DWSRF.

The Department does not propose replacing this regulation with a new regulation. The Department and RIA are able to effectively administer and implement the SRF program using the state statute, Title 48, Chapter 5, and federal laws, regulations, and grant requirements that govern the use of the funds. Other existing state laws and regulations also are used to implement the program such as environmental permitting regulations that govern the design and construction of wastewater and drinking water infrastructure projects.

## DETERMINATION OF COSTS AND BENEFITS:

The Department anticipates no fiscal or economic impact on the state or its political subdivisions and the regulated community by the repeal of this regulation. Repeal of the regulation will have no impact or implications for the current administration and implementation of the South Carolina CWSRF. The CWSRF, like its predecessor, the State Water Pollution Revolving Fund under the repealed Title 48, Chapter 6, provides low interest loans to public utilities and local governments for wastewater and stormwater infrastructure projects. The Department and RIA are able to effectively administer and implement the CWSRF and DWSRF using the state statute, Title 48, Chapter 5, and federal laws, regulations, and grant requirements that govern the use of the funds. Other existing state laws and regulations also are used to implement the program such as environmental permitting regulations that govern the design and construction of wastewater and drinking water infrastructure projects.

## UNCERTAINTIES OF ESTIMATES:

None.

## EFFECT ON THE ENVIRONMENT AND PUBLIC HEALTH:

Repealing the regulation will have no effect on the environment and public health. The Department and RIA are able to effectively administer and implement the CWSRF and DWSRF using the state statute, Title 48, Chapter 5, and federal laws, regulations, and grant requirements that govern the use of the funds. Other existing state laws and regulations also are used to implement the program such as environmental permitting regulations that govern the design and construction of wastewater and drinking water infrastructure projects.

## DETRIMENTAL EFFECT ON THE ENVIRONMENT AND PUBLIC HEALTH IF THE REGULATION IS NOT IMPLEMENTED:

Repealing R.61-67.1 has no legal effect, as it has been obsolete since repeal of S.C. Code Section 48-6-10 et seq.

## **Statement of Rationale:**

R.61-67.1 needs to be repealed as it is obsolete due to repeal of the original authorizing statute (Title 48, Chapter 6). The General Assembly repealed Title 48, Chapter 6 and replaced it with the South Carolina Water Quality Revolving Fund Authority Act (Title 48, Chapter 5). The Department does not propose replacing this regulation with a new regulation. The Department and RIA are able to effectively administer and implement the CWSRF and DWSRF using the state statute, Title 48, Chapter 5, and federal laws, regulations, and grant requirements that govern the use of the funds. Other existing state laws and regulations also are used to implement the program such as environmental permitting regulations that govern the design and construction of wastewater and drinking water infrastructure projects.

## **Text:**

~~Indicates Matter Stricken~~

Indicates New Matter

61-67.1. Requirements for State Water Pollution Control Revolving Fund Loan Assistance.

### ~~I. Introduction~~

#### ~~— A. Authorization~~

~~— The Federal Water Pollution Act (92-500) as amended, otherwise known as the Clean Water Act (CWA), sets forth a schedule and mechanism for completing the transition to full State and Local responsibility for construction of Publicly Owned Treatment Works (POTW). To replace the Environmental Protection Agency (EPA) Construction Grants Program, new authority is given to EPA to make grants to capitalize State Water Pollution Control Revolving Funds (SRFs), the primary purpose of which is to provide loans and other financial assistance for the construction of wastewater treatment facilities.~~

~~— SRF capitalization grants are authorized from Fiscal Year 1989 through Fiscal Year 1994. After the Fiscal Year 1994 funds are spent, the Federal role will no longer include financial assistance to States or~~

~~Municipalities for wastewater treatment facilities construction. The States and Municipalities will thereafter have the sole responsibility for providing financing to meet the enforceable requirements of the Act.~~

~~— The 1987 South Carolina General Assembly created the State Water Pollution Revolving Fund, Title 48, Chapter 6. This legislation gives the Budget and Control Board the responsibility for managing the fiscal aspects of the Fund and Department of Health and Environmental Control (DHEC) the responsibility for administering the technical and programmatic portions of the Fund.~~

#### ~~— B. Objectives~~

~~— The purpose of the State Water Pollution Control Revolving Fund is to create a financial assistance program, as mandated under the Federal Water Pollution Control Act Amendments of 1987, to:~~

~~— 1. Assist project sponsors in meeting Federal and State mandated wastewater treatment levels and service standards.~~

~~— 2. Provide a long term source of financing for wastewater treatment needs.~~

~~— 3. Encourage self sufficiency at the State and Local levels for wastewater financing.~~

~~— 4. Provide affordable financing to eligible project sponsors.~~

#### ~~— C. Definitions~~

~~— The following terms as used in these regulations shall have the meaning ascribed to them in this chapter:~~

~~— 1. "Act" means Public Law 92-500 as amended by Public Law 100-4; the "Water Quality Act of 1987."~~

~~— 2. "Agency" means the United States Environmental Protection Agency.~~

~~— 3. "Board" means the South Carolina Budget and Control Board.~~

~~— 4. "Department" means the South Carolina Department of Health and Environmental Control.~~

~~— 5. "Fund" means the money initially received from capitalization grants pursuant to the Act, all associated State match money, repayments of all principal and interest on loans made from the Fund, interest accruing to the Fund and any leveraged money applied to the Fund.~~

~~— 6. "Loan Agreement" means the agreement or contract made between a project sponsor and the Board which provides for State assistance to the project sponsor and for the repayment thereof by the project sponsor.~~

~~— 7. "Project Sponsor or Loan Recipient" means any county, municipality, intermunicipal, interstate or state agency, or special purpose district, excluding any special purpose districts (e.g. a school, an airport, etc.) whose primary purpose is not wastewater treatment.~~

#### ~~— D. Eligible Applicants~~

~~— Any municipality, county, intermunicipal, interstate or state agency, or special purpose district whose primary function is wastewater treatment, is eligible to seek financial assistance from the SRF.~~

#### ~~— E. Eligible Types of Financial Assistance~~

~~— All monies within the Fund must be used solely to provide loans and other authorized forms of financial assistance, but not grants. Other forms of financial assistance may include the following:~~

~~— 1. Guarantees — The Fund may be used to guarantee local debt obligations or purchase bond insurance where such actions would improve credit market access or reduce interest rates. Any project receiving this type of assistance must comply with all requirements applicable to projects financed directly by Fund loans. No monies in the Fund may be used to finance a reserve account for a municipal bond issue.~~

~~— 2. Refinancing — The Fund may be used to refinance a local debt obligation at or below market rate when such debt was incurred after March 7, 1985. The project, however, must have complied with all requirements applicable to projects initially financed by Fund loans. Furthermore, where the original debt was in the form of a multi-purpose bond incurred for purposes extending beyond wastewater treatment facility construction, the Fund may provide refinancing only for eligible purposes and not for the entire debt.~~

#### ~~— F. Eligible Types of Activities~~

~~— Financial assistance for eligible sponsors is limited to the following uses:~~

~~— 1. Construction of projects for secondary treatment, advanced treatment, or any cost-effective alternative to secondary or advanced treatment, new interceptors and appurtenances and infiltration/inflow correction. Up to 20% of the Fund may be used for major rehabilitation or replacement of collectors, provided the collectors are needed to assure the total integrity of the system, or for new collectors in an existing community, where sufficient treatment capacity exists.~~

~~— 2. Implementation of a non-point source pollution control management program. The project must be consistent with plans developed under Section 319 of the Act.~~

~~— 3. Development and implementation of an estuary conservation and management plan. The project must be consistent with plans developed under Section 320 of the Act.~~

~~— All projects subject to paragraphs 1, 2 and 3 must appear on the State's annual priority list.~~

#### ~~— G. Impact of Future Agency Rules and Regulations~~

~~— Any provision of the State regulations contained herein that is contrary to or inconsistent with subsequent Agency guidance, rules or regulations shall be immediately deemed null and void, and any associated changes shall be addressed through State policy memoranda.~~

#### ~~— II. Requirements Placed on Loan Recipients~~

~~— This chapter provides an overview of the primary Federal and State requirements which will apply to recipients of financial assistance from the Fund. As prescribed by the Act, Federal requirements for the Fund largely parallel the Title II Construction Grants Regulations. Additional cross-cutting Federal laws and directives will also apply to the Fund's use. The Department will apply most of the construction grant regulations but will streamline those procedures, to the extent permissible, to more appropriately address~~

financing by loans. In addition, the Department will issue guidance for project sponsor's responsibilities under other Federal laws and directives.

Necessary additional requirements and compliance standards will be addressed through separate program guidance. This guidance will identify areas of compliance by subject or requirement, identify the sponsor's role, its responsibility and the required compliance documentation needed. The State's role in the review and approval process will also be identified.

#### A. Federal Programmatic Requirements

An overview of the Federal regulations applicable to all loan recipients is presented in this section. Many of the Federal requirements are planning regulations and apply to completion of a facilities plan as has been required under the Agency's construction grants program. A facilities plan must be prepared for all projects, except nonpoint source and estuary projects which will require specific planning.

The facilities plan and final plans and specifications must be approved prior to the submission of an application for construction financing. The cost of preparing a facilities plan and final plans and specifications may be eligible for reimbursement through the loan program once a construction loan is approved. The following summarizes the Federal requirements that must be met for all loan applicants and recipients pursuant to the provisions of the Act.

1. Best Practicable Waste Treatment Technology—Section 201(b) requires that projects apply best practicable waste treatment technology (see CFR 35.2005(b)(7): Definition of BPWTT, 40 CFR 35.2030(b)(2): Facilities Planning);

2. Categories of Need—Section 201(g)(1) limits assistance to projects for secondary treatment, advanced treatment, or any cost effective alternative, new interceptors and appurtenances, and infiltration inflow correction. This Section retains the Governor's discretionary set aside by which a State can use up to 20 percent of its allotment for other projects within the definition of treatment works in Section 212(2), and for certain nonpoint source control and groundwater protection purposes, as defined in Section 319 of the Act and subsequent Agency regulations (40 CFR 35.2015(b)(2)(ii-iv): State Priority System and Project Priority List);

3. Alternative Waste Management Techniques—Section 201(g)(2) requires that alternative technologies be considered in project design (40 CFR 35.2030: Facilities Planning);

4. Infiltration/Inflow—Section 201(g)(3) requires the applicant to show that the related sewer collection system is not subject to excessive infiltration (40 CFR 35.2030(b)(4): Facilities Planning, 40 CFR 35.2120: Infiltration/Inflow);

5. Innovative/Alternative Technology—Section 201(g)(5) requires that applicants study innovative and alternative treatment technologies and take into account opportunities to construct revenue producing facilities and to make more efficient uses of energy and resources (40 CFR, 35.2030: Facilities Planning);

6. Recreation and Open Space Opportunities—Section 201(g)(6) requires that the applicant analyze the potential recreation and open space opportunities in the planning of the proposed facilities (40 CFR—35.2030(b)(5): Facilities Planning);

7. Water Quality Management Planning—Section 204(a)(1) and (2) requires that treatment works projects be included in plans developed under Sections 208 and 303(e), (40 CFR 35.2101: Water Quality Management Plans);

~~8. Sewer Use Ordinance/User Charge System—Section 204(b)(1) requires communities to develop user charge systems and to have the legal, institutional, managerial, and financial capability to construct, operate, and maintain the treatment works (40 CFR 35.2208: Adoption of Sewer Use Ordinance and User Charge System, 35.2130: Sewer Use Ordinance, 35.2140: User Charge System, and 35.2214: Grantee Responsibilities, 35.2122: Approval of User Charge System and proposed Sewer Use Ordinance, 35.2110: Access to Individual Systems, and 35.2206(a): Operation and Maintenance);~~

~~9. Project Performance—Section 204(d)(2) requires that one year after the date of construction the owner/operator of the treatment works must certify that the facility meets design specifications and effluent limitations included in its permit (40 CFR 35.2218(e), (d) and (e)(2): Project Performance);~~

~~10. Governor's Discretionary Fund—Section 211 provides that major rehabilitation or replacement of collectors is not eligible under the Governor's 20 percent discretionary authority of 201(g)(1) unless the collector is needed to assure the total integrity of the treatment works, or that, for a new collector, adequate capacity exists at the facilities (40 CFR 35.2116 Collection System);~~

~~11. Value Engineering—Section 218 assures that treatment systems are cost effective and requires that projects of over \$10 million include a value engineering review (40 CFR 35.2030(b)(3): Cost Effectiveness, Facilities Planning, and 35.2114: Value Engineering).~~

~~12. Environmental Review—Section 511(c)(1). Under Title VI of the Act, the State must conduct a NEPA (National Environmental Policy Act) like review (as conducted under the Agency Construction Grants Program) of projects constructed with monies from the Fund program. South Carolina must assure that all treatment works constructed in whole or in part with monies provided from the Fund, will be subject to a NEPA like review to evaluate the possible environmental impacts, including secondary impacts, associated with such construction. This environmental review requirement is included because the potential exists for undesirable environmental side effects resulting from inappropriate design or site location, or from the promotion of uncontrolled residential, commercial, or industrial development. These reviews will provide for adequate public involvement. The Department will use the NEPA review process until such time as its own procedures have been developed and approved by EPA.~~

~~13. For the environmental assessment review and requirements cited above, the following Federal acts and rules may also apply to the loan project:~~

~~1. Archeological and Historic Preservation Act of 1974~~

~~2. Executive Order 11990 Protection of Wetlands~~

~~3. National Historic Preservation Act of 1966 as awarded~~

~~4. Executive Order 11988 Floodplain Management~~

~~5. Clean Air Act~~

~~6. Federal Water Pollution Control Act as amended~~

~~7. State Clearinghouse Presidential Executive Order 12372.~~

~~Consideration to the above acts, legislation and authority rules must be given during the Environmental Assessment Review.~~



~~14. Davis-Bacon Act Section 513 applies Davis-Bacon labor wage provisions to treatment works construction (see 29 CFR Part 5). Wages paid for the construction of treatment works must conform to the prevailing wage rates established for the locality by the U. S. Department of Labor under the Davis-Bacon Act (Section 513, applies 40 U.S.C. 276 et seq.).~~

~~15. Other cross-cutting Federal laws and directives as mandated by the Agency that may impact the loan project include, but not limited to, the following:~~

~~1. Copeland "Anti-Kickback" Act.~~

~~2. Contract Work Hours and Safety Standards Act.~~

~~3. Federal Equal Opportunity, Non-Discrimination and Civil Rights Act and Laws.~~

~~4. Buy American (Executive Order).~~

~~B. State Programmatic Requirements~~

~~1. The sponsor is responsible for compliance with:~~

~~a. The South Carolina Pollution Control Act.~~

~~b. State guidance issued for procurement, property management and other applicable procedures.~~

~~c. Laws, rules and regulations and guidance documents governing the planning, design and construction of the project.~~

~~d. The development and maintenance of records, documents, and procedures to establish adherence to all State issued guidance.~~

~~2. The Department will perform site visits and routine inspections of facilities in order to resolve problems, provide technical and administrative assistance, and ensure compliance in all program areas or support any deviations or variances necessary prior to a project compliance audit. The Department will perform interim and final construction inspections to ensure construction consistency and adequacy.~~

~~3. The project sponsor will be responsible for the preparation and submission of all data and reports determined necessary by the Department and the Board.~~

~~C. Financial Requirements~~

~~The following identifies major financial requirements that will apply to all loan recipients. Additional financial requirements and responsibilities governing loans from the Fund will be defined in the loan application package, the loan agreement and specific guidance memoranda as appropriate.~~

~~1. Each loan applicant must establish one or more dedicated repayment sources that contain sufficient revenues to operate and maintain the system and cover debt service payments for the duration of the loan. Dedicated sources of revenue may be user charges, special assessments, general taxes, general obligation bonds, revenue bonds or other sources available to the project sponsor.~~

~~2. All loan recipients must maintain separate project accounts in accordance with “generally accepted government accounting standards.” Unless otherwise directed by the Board, these standards are defined as those contained in the U. S. General Accounting Office publication “Standards for Audit of Governmental Organizations, Programs, Activities and Functions,” dated 2/27/81.~~

~~3. Each loan recipient is required to conduct an annual audit and submit it to the Board. Audit guidelines are set forth in the Single Audit Act of 1984, OMB Circular A-128 and the U. S. General Accounting Office’s “Standards for Audit of Governmental Organization, Programs, Activities and Functions.”~~

~~4. Each project sponsor must comply with all terms and conditions set forth in the legally binding loan agreement which will be executed between the loan recipient and the Board before any monies are awarded.~~

### ~~III. Priority, Selection and Application Process~~

~~The following represents a general description of the process and procedures involved in applying for a loan from the Fund. Further information will be available through public notices and mass mailings. Instructions and guidance detailing specific requirements will also be provided to potential loan applicants.~~

~~1. To be eligible for consideration for a loan in any given year, the project must be on the State’s annual project priority list for that year. Placement on the priority list is dependent upon the project sponsor submitting a complete priority list questionnaire to the Department within the prescribed time frame. Questionnaires are available from the Department or the Board.~~

~~2. The priority system for ranking and selecting projects on the annual priority list will be developed by the Department and the Board and will be available for public comment. It should be noted that due to new Agency requirements, readiness to proceed will be a dominant factor in determining which projects on the list will be eligible to apply for loans. Higher ranked projects that are not ready to proceed will lose the opportunity for a loan to lower ranked projects that are ready.~~

~~3. Once a project is determined to be a potential loan recipient and the project sponsor has satisfied all technical and programmatic requirements as defined by the Department, the project sponsor will then submit a complete loan application to the Board. Loan applications will be available from the Board or the Department.~~

~~4. Project Sponsors fulfilling all programmatic requirements, satisfying all requirements of the financial review, and evidencing a sound ability to repay the financial assistance will be offered a loan.~~

~~5. The loan becomes final when the project sponsor enters into a legally binding loan agreement with the Board.~~

### ~~IV. Financial Provisions~~

#### ~~A. Loan Policies~~

~~Specific loan policies, including but not limited to interest rates, terms, deferments, funding caps, repayment provisions and disbursement requirements will be established by the Board in advance of Fund implementation and made available for distribution to potential project sponsors.~~

#### ~~B. Loan Agreements~~

~~— Prior to awarding any loan, the project sponsor and the Board shall enter into a loan agreement containing, without limitation, the following:~~

~~—— 1. The cost of the project, the amount of the loan, the terms of repayment and security for the loan.~~

~~—— 2. The specific purpose for which proceeds of the loan may be expended, the requirements and procedures for disbursement of the loan and the duties and obligations imposed upon the loan recipient regarding the construction or completion of the project.~~

~~—— 3. The agreement of the loan recipient to impose, collect and, if required to ensure repayment of the obligations according to the terms of the loan agreement, increase user charges, taxes or other dedicated revenue sources identified for the loan repayment.~~

~~—— 4. The agreement of the loan recipient to comply with all applicable laws, rules and regulations issued by the Department, the Board or other State, Federal and Local bodies in regard to the financing, construction, operation, maintenance and use of the wastewater facilities project.~~

#### ~~—— C. Loan Delinquency Provisions~~

~~—— Pursuant to authority provided in Section 48-6-70(B) of Title 48 of the 1976 South Carolina Code of Laws, as amended, any failure of the project sponsor to make payment to the Board according to the prescribed repayment schedule will result in the Board requiring the State Treasurer and the Comptroller General to pay the Board the amount of other State aid the local unit may become entitled to until all delinquent payments plus interest have been paid. If the loan recipient is a special purpose district and receives no other State aid, the Board will notify the Controller General to levy, and require the applicable County Treasurer to collect and remit to the Board, a special tax sufficient to cover the delinquent payments plus interest, and, if necessary, to ensure continued repayment of the loan. Additionally, should the loan of any project sponsor be declared delinquent, the Board may also take action to preclude the loan recipient from receiving grant funds or other types of financial assistance available from State agencies, unless otherwise prohibited by law, until such time as all amounts due on the loan have been paid and the loan is declared current.~~

HISTORY: Adopted by State Register Volume 12, Issue No. 6, eff June 24, 1988 [Repealed].

## **ATTACHMENT B**

### **DEPARTMENT OF HEALTH AND ENVIRONMENTAL CONTROL**

#### **CHAPTER 61**

Statutory Authority: 1976 Code Sections 48-5-10 et seq.

#### **Notice of Drafting:**

The Department of Health and Environmental Control (“Department”) proposes repealing Regulation 61-67.1, Requirements for State Water Pollution Control Revolving Fund Loan Assistance. Interested persons may submit comments to Charles Gorman, Water Facilities Permitting Division, Bureau of Water, 2600 Bull Street, Columbia, S.C. 29201 or via email at [gormancm@dhec.sc.gov](mailto:gormancm@dhec.sc.gov). To be considered, comments must be received no later than 5:00 p.m. on July 23, 2018, the close of the draft comment period.

#### **Synopsis:**

Originally authorized by Title 48, Chapter 6 of the South Carolina Code, R.61-67.1 describes the process the Department and the former South Carolina Budget and Control Board followed in administering State Water Pollution Revolving Funds received in federal grants from the U.S. Environmental Protection Agency (“EPA”). In 1992, the General Assembly repealed Title 48, Chapter 6 and replaced it with the South Carolina Water Quality Revolving Fund Authority Act (Title 48, Chapter 5). Title 48, Chapter 5 provides statutory authority for the Department and the South Carolina Water Quality Revolving Fund Authority to administer the South Carolina clean water and drinking water revolving funds and federal grants received as supplements to the revolving funds from the EPA. The South Carolina Water Quality Revolving Fund Authority is comprised of the members of the State Fiscal Accountability Authority with administrative and implementation support from the South Carolina Rural Infrastructure Authority (“RIA”).

The Department proposes repealing R.61-67.1, as the regulation is outdated due to repeal of the original authorizing statute. The Department does not propose replacing this regulation with a new regulation. The Department and RIA are able to effectively administer and implement the state revolving fund program using Title 48, Chapter 5, other existing state laws and regulations, and federal laws, regulations, and grant requirements that govern the use of the funds.

General Assembly review is required.

(x) ACTION/DECISION  
( ) INFORMATION

Date: October 11, 2018

To: S.C. Board of Health and Environmental Control

From: Bureau of Land and Waste Management

**Re: Notice of Proposed Regulation Amending Regulation 61-79, Hazardous Waste Management Regulations.**

**I. Introduction**

The Bureau of Land and Waste Management (“Bureau”) proposes the attached Notice of Proposed Regulation amending Regulation 61-79, ~~Hazardous Waste Management Regulations~~ *South Carolina State Register* in the October 26, 2018 ~~South Carolina State Register~~ *State Register*. Legal authority for this amendment resides in the South Carolina Hazardous Waste Management Act, S.C. Code Ann. § 44-56-30, which authorizes the Department of Health and Environmental Control (“Department”) to promulgate hazardous waste management regulations, procedures, or standards as may be necessary to protect human health and the environment. The Administrative Procedures Act, S.C. Code Ann. § 1-23-120(A), requires General Assembly review of this amendment.

**II. Facts**

1. The Bureau proposes amending R.61-79 to adopt the Environmental Protection Agency’s (“EPA”) Hazardous Waste Generator Improvements Rule published November 28, 2016, at 81 FR 85732-85829. The Hazardous Waste Generator Improvements Rule reorganizes the hazardous waste generator regulations to improve their usability by the regulated community, provide a better understanding of how the Resource Conservation and Recovery Act (“RCRA”) hazardous waste generator regulatory program works, address gaps in existing regulations to strengthen environmental protections, provide greater flexibility for hazardous waste generators to manage their hazardous waste in a cost-effective and protective manner, and make technical corrections to address inadvertent errors and remove obsolete references to programs that no longer exist.
2. The EPA periodically promulgates regulations that are either mandatory for authorized state programs to adopt or maintain program equivalency or are optional for states because the changes are less stringent than the current federal regulations. While the majority of the EPA’s Hazardous Waste Generator Improvements Rule is equivalent to current state regulations and optional for state adoption, several provisions are more stringent and must be adopted by the Department to maintain federal program authorization. Due to the interrelated nature of the equivalent provisions and the more stringent provisions, the Department proposes adopting the rule in a single drafting that requires General Assembly review.
3. The Department had a Notice of Drafting published in the April 27, 2018 ~~State Register~~ *State Register*. The Department received no public comments by the May 28, 2018, the close of the public comment period.
4. Appropriate Department staff conducted an internal review of the proposed amendment on August 7, 2018.
5. The Department conducted outreach meetings with the South Carolina Chamber of Commerce Environmental Technical Committee. The Department also published a notice on the Regulation Development Update webpage and provided notice to interested parties *via* email.

### III. Request for Approval

The Bureau respectfully requests the Board to grant approval of the attached Notice of Proposed Regulation for publication in the October 26, 2018 *State Register*.



Henry J. Porter, Chief  
Bureau of Land and Waste Management



Myra Reece, Director  
Environmental Affairs

**Attachments:**

- A. Notice of Proposed Regulation
- B. Notice of Drafting published in the April 27, 2018, *State Register*

## ATTACHMENT A

### STATE REGISTER NOTICE OF PROPOSED REGULATION FOR REGULATION 61-79, *Hazardous Waste Management Regulations*

October 11, 2018

Document No. \_\_\_\_\_

#### DEPARTMENT OF HEALTH AND ENVIRONMENTAL CONTROL

CHAPTER 61

Statutory Authority: 1976 Code Section 44-56-30

61-79. Hazardous Waste Management Regulations.

#### Preamble

The Department of Health and Environmental Control (“Department”) proposes to amend R.61-79, Hazardous Waste Management Regulations, to adopt the Environmental Protection Agency’s (“EPA”) Hazardous Waste Generator Improvements Rule published November 28, 2016, at 81 FR 85732-85829. The proposed amendments will support the Department’s goal of promoting and protecting the health of the public and the environment in a more efficient and effective manner.

The amendments will reorganize the hazardous waste generator regulations to improve their usability by the regulated community, provide a better understanding of how the Resource Conservation and Recovery Act (“RCRA”) hazardous waste generator regulatory program works, address gaps in existing regulations to strengthen environmental protections, provide greater flexibility for hazardous waste generators to manage their hazardous waste in a cost-effective and protective manner, and make technical corrections to address inadvertent errors and remove obsolete references to programs that no longer exist.

The EPA periodically promulgates regulations that are either mandatory for authorized state programs to adopt or maintain program equivalency or are optional for states because the changes are less stringent than the current federal regulations. While the majority of the EPA’s Hazardous Waste Generator Improvements Rule is equivalent to current state regulations and optional for state adoption, several provisions are more stringent and must be adopted by the Department to maintain federal program authorization. Due to the interrelated nature of the equivalent provisions and the more stringent provisions, the Department proposes adopting the rule in a single drafting that requires General Assembly review.

The Department had a Notice of Drafting published in the April 27, 2018, South Carolina State Register.

Section-by-Section Discussion of Proposed Amendment:

260.3. Revise introductory phrase to read, “As used in R.61-79.260 through R.61-79.273.”

260.10. Definitions. Add, in alphabetical order, the following new definitions: “Acute hazardous waste,” “Central accumulation area,” “Large quantity generator,” “Non-acute hazardous waste,” and “Very small quantity generator.” Revise definition for “Small quantity generator.” Remove definition for “Conditionally exempt small quantity generators.”

260.11. Revise section heading to read, “Incorporation by reference.”

260.11(a)(10). Revise item to read, “‘Flammable and Combustible Liquids Code’ (NFPA 30), 1977 or 1981, IBR approved for R.61-79.262.16(b), 264.198(b), and 265.198(b).”

261.1(a)(1). Revise item to replace “conditionally exempt” with “very.”

261.4(a)(7). Revise item to replace “, unless it is” with “provided it is not.”

261.5. Remove and reserve section.

261.6(c)(2)(iv). Add new item (2)(iv) to adopt language that includes section 265.75 of this chapter (quarterly report).

261.33(e). Revise subsection to remove phrase, “and are subject to the small quantity exclusion defined in section 261.5(e).”

261.33(f). Revise subsection to remove phrase, “and are subject to the small quantity generator exclusion defined in section 261.5(a) and (g).”

262.1. Add new section titled, “Terms used in this part” to adopt language that lists definitions used in this subpart, including “Condition for exemption” and “Independent requirement.”

262.10(a). Revise subsection to read, “These regulations establish standards for generators of hazardous waste as defined by R.61-79.260.10.”

262.10(a)(1). Add new item (1) to adopt language that describes how a person who generates a hazardous waste as defined by R.61-79.261 is subject to all applicable independent requirements listed in this section.

262.10(a)(1)(i). Add new item (1)(i) and items (1)(i)(A) through (C) to adopt language that lists the independent requirements of a very small quantity generator.

262.10(a)(1)(ii). Add new item (1)(ii) and items (1)(ii)(A) through (I) to adopt language that lists the independent requirements of a small quantity generator.

262.10(a)(1)(iii). Add new item (1)(iii) and items (1)(iii)(A) through (H) to adopt language that lists the independent requirements of a large quantity generator.

262.10(a)(2). Add new item (2) and items (2)(i) through (iii) to adopt language that describes a generator that accumulates hazardous waste on site is a person that stores hazardous waste and must follow the applicable requirements unless one of the exemptions listed is met.

262.10(a)(3). Add new item (3) to adopt language that describes how a generator shall not transport, offer its hazardous waste for transport, or otherwise cause its hazardous waste to be sent to a facility that is not a designated facility, as defined in section 260.10, or not otherwise authorized to receive the generator’s hazardous waste.

262.10(b). Revise subsection to read, “Determining generator category. A generator must use R.61.79.262.13 to determine which provisions of this part are applicable to the generator based on the quantity of hazardous waste generated per calendar month.”

262.10(c). Remove and reserve item.



262.10(g). Revise subsection to remove the current language and add new items (1) and (2) to adopt language that describes how compliance and noncompliance of a person who generates hazardous waste is subject to the requirements of the SC Hazardous Waste Management Act and RCRA.

262.10(i) Notes 1 and 2. Remove Note 1 and rename “Note 2” to “Note”-4.”

262.10(l). Revise item for clarification.

262.10(l)(1). Revise item to add “independent” before “requirements” and replace “262.34(c)” with “the regulations in section 262.15.”

262.10(l)(2). Revise item to read, “The conditions of section 262.14, for very small quantity generators, except as provided in subpart K.”

262.11. Revise section title to add “and recordkeeping” at the end of the title. Revise introductory paragraph to: remove “accurately determine if” and insert “make an accurate determination as to whether,” and remove “using the following method” and insert “in order to ensure wastes are properly managed according to applicable RCRA regulations. A hazardous waste determination is made using the following steps.”

262.11(a). Revise subsection to read, “The hazardous waste determination for each solid waste must be made at the point of waste generation, before any dilution, mixing, or other alteration of the waste occurs, and at any time in the course of its management that it has, or may have, changed its properties as a result of exposure to the environment or other factors that may change the properties of the waste such that the RCRA classification of the waste may change.”

262.11(b). Revise subsection to read, “A person must determine whether the solid waste is excluded from regulation under R.61-79.261.4.”

262.11(c). Revise subsection to read, “If the waste is not excluded under R.61-79.261.4, the person must then use knowledge of the waste to determine whether the waste meets any of the listing descriptions under subpart D of R.61-79.261. Acceptable knowledge that may be used in making an accurate determination as to whether the waste is listed may include waste origin, composition, the process producing the waste, feedstock, and other reliable and relevant information. If the waste is listed, the person may file a delisting petition under R.61-79.260.20 and 260.22 to demonstrate to the Department that the waste from this particular site or operation is not a hazardous waste.” Remove items 262.11(c)(1) and (2).

262.11(d). Revise subsection to read, “The person then must also determine whether the waste exhibits one or more hazardous characteristics as identified in subpart C of R.61-79.261 by following the procedures in paragraph (d)(1) or (2) of this section, or a combination of both.”

262.11(d)(1). Add new item (1) to adopt language that describes how the person must apply knowledge of the hazard characteristic of the waste in light of the materials or the processes used to generate the waste.

262.11(d)(2). Add new item (2) and items (2)(i) and (ii) to adopt language that describes how the person must test the waste according to the applicable methods set forth in subpart C of R.61-70.261 or according to an equivalent method approved by the Department under R.61-79.260.21 and in accordance with the requirements in 262.11(d)(2)(i) and (ii) when available knowledge is inadequate to make an accurate determination.

262.11(e). Revise subsection to read, “If the waste is determined to be hazardous, the generator must refer to R.61-79.261, 264, 265, 266, 268, and 273 for other possible exclusions or restrictions pertaining to management of the specific waste.”

262.11(f). Add new subsection (f) to adopt language that describes the recordkeeping requirements for small and large quantity generators.

262.11(g). Add new subsection (g) to adopt language that describes if the waste is determined to be hazardous, small quantity generators and large quantity generators must identify all applicable EPA hazardous waste numbers (EPA hazardous waste codes) in subparts C and D of R.61-79.261. Prior to shipping the waste off site, the generator also must mark its containers with all applicable EPA hazardous waste numbers (EPA hazardous waste codes) according to section 262.32.

262.12. Revise section to remove current language and adopt language that describes the notification requirements upon generators that was previously in section 262.13.

262.13. Revise section title to read, “Generator category determination.” Add new introductory text to adopt language that describes how a generator must determine its generator category based on the amount of hazardous waste generated each month and may change from month to month. This section sets forth procedures to determine whether a generator is a very small quantity generator, a small quantity generator, or a large quantity generator for a particular month, as defined in R.61-79.260.10.

262.13(a). Revise subsection and add items (1) through (3) to adopt language that describes how the generator category for the month is determined by a generator of either acute or non-acute hazardous waste.

262.13(b). Revise subsection and add items (1) through (4) to adopt language that describes how the generator category for the month is determined by a generator of both acute and non-acute hazardous waste.

Table 1 to 262.13. Add new Table 1 to adopt language to list and describe how the generator categories are determined based on quantity of waste generated in a calendar month.

262.13(c). Revise subsection and add items (1) through (8) to adopt language that describes how the generator must include all hazardous waste that is generated when making the monthly quantity-based determinations required, unless the hazardous waste adheres to one of the listed exemptions.

262.13(d). Revise subsection and add items (1) through (3) to adopt language that describes how a generator does not need to include certain items when determining the quantity of hazardous waste generated in a calendar month.

262.13(e). Revise subsection to read, “Based on the generator category as determined under this section, the generator must meet the applicable independent requirements listed in ~~section~~ R.61-79.262.10. A generator's category also determines which of the provisions of ~~sections~~ R.61-79.262.14, 262.15, 262.16, or 262.17 must be met to obtain an exemption from the storage facility permit, interim status, and operating requirements when accumulating hazardous waste.” Remove items 262.13(e)(1) through (3).

262.13(f). Revise subsection to read, “Mixing hazardous wastes with solid wastes.”

262.13(f)(1). Add new item (1) and items (1)(i) through (iii) to adopt language to describe requirements and guidelines for mixing very small quantity generator wastes with solid wastes.

262.13(f)(2). Add new item (2) and items (2)(i) and (ii) to adopt language to describe requirements and guidelines for mixing small quantity generator and large quantity generator wastes with solid wastes.

262.14. Add new section titled “Conditions for exemption for a very small quantity generator.”

262.14(a). Add new subsection (a) to adopt language that describes how hazardous waste generated by the very small quantity generator is not subject to the requirements of R.61-79.124, 262 (except sections 262.10-262.14) through 268, and 270, and the notification requirements of section 3010 of RCRA and the very small quantity generator may accumulate hazardous waste on site without complying with such requirements provided that the very small quantity generator meets all the conditions for exemption listed in 262.14(a)(1) through (5).

262.14(a)(1). Add new item (1) to adopt language that describes a condition for exemption for very small quantity generators that in a calendar month generates less than or equal to the amounts specified in the definition of “very small quantity generator” in section 260.10.

262.14(a)(2). Add new item (2) to adopt language that describes a condition for exemption for very small quantity generators that the generator complies with 262.11(a) through (d).

262.14(a)(3). Add new item (3) and items (3)(i) and (ii) to adopt language that describes the condition for exemption for very small quantity generators that if the generator accumulates at any time greater than 1 kilogram (2.2 pounds) of acute hazardous waste or 100 kilograms (220 pounds) of any residue or contaminated soil, water, or other debris resulting from the cleanup of a spill, into or on any land or water, of any acute hazardous waste listed in sections 261.31 or 261.33(e), all quantities of that acute hazardous waste are subject to the additional conditions for exemption listed in sections 262.14(a)(3)(i) and 262.14(a)(3)(ii).

262.14(a)(4). Add new item (4) and items (4)(i) through (iii) to adopt language that describes additional conditions for exemption on all quantities of that hazardous waste if the very small quantity generator accumulates at any time 1,000 kilograms (2,200 pounds) or greater of non-acute hazardous waste.

262.14(a)(5). Add new item (5) and items (5)(i) through (viii) to adopt language that describes how a very small quantity generator that accumulates hazardous waste in amounts less than or equal to the limits in paragraphs (a)(3) and (4) of this section must either treat or dispose of its hazardous waste in an on-site facility or ensure delivery to an off-site treatment, storage, or disposal facility, either of which, if located in the U.S., is authorized under specific conditions described in items (5)(i) through (viii).

262.14(b). Add new subsection (b) to adopt language that describes the placement of bulk or non-containerized liquid hazardous waste or hazardous waste containing free liquids (whether or not sorbents have been added) in any landfills is prohibited.

262.14(c). Add new subsection (c) to adopt language that describes how a very small quantity generator experiencing an episodic event may generate and accumulate hazardous waste in accordance with subpart L of this part in lieu of sections 262.15, 262.16, and 262.17.

262.15. Add new section titled “Satellite accumulation area regulations for small and large quantity generators.”

262.15(a). Add new subsection (a) to adopt language that describes how a generator may accumulate as much as 55 gallons of non-acute hazardous waste and/or either one quart of liquid acute hazardous waste listed in section 261.31 or 261.33(e) or 1 kg (2.2 pounds) of solid acute hazardous waste listed in section

261.31 or 261.33(e) in containers at or near any point of generation where wastes initially accumulate which is under the control of the operator of the process generating the waste, without a permit or interim status and without complying with the requirements of R.61-79.124, 264 through 267, and 270, provided that all of the conditions for exemption in this section are met. A generator may comply with the conditions for exemption in this section instead of complying with the conditions for exemption in 262.16(b) or 262.17(a), except as required in section 262.15(a)(7) and (8).

262.15(a)(1). Add new item (1) to adopt language that describes the condition for exemption for satellite accumulation if a container holding hazardous waste is not in good condition, or if it begins to leak, the generator must immediately transfer the hazardous waste from this container to a container that is in good condition and does not leak, or immediately transfer and manage the waste in a central accumulation area operated in compliance with 262.16(b) or 262.17(a).

262.15(a)(2). Add new item (2) to adopt language that describes the condition for exemption for satellite accumulation is a generator must use a container made of or lined with materials that will not react with, and are otherwise compatible with, the hazardous waste to be accumulated, so that the ability of the container to contain the waste is not impaired.

262.15(a)(3). Add new item (3) and items (3)(i) through (iii) to adopt language that describes the special standards for incompatible wastes for satellite accumulation for small and large quantity generators.

262.15(a)(4). Add new item (4) and items (4)(i) and (ii) to adopt language that describes how a container holding hazardous waste must be closed at all times during accumulation, except: when adding, removing or consolidating waste; when temporary venting of a container is necessary for the proper operation of equipment; or when temporary venting of a container is necessary to prevent dangerous situations, such as build-up of extreme pressure.

262.15(a)(5). Add new item (5) and items (5)(i) and (ii) to adopt language that describes how a generator must mark or label its container with the criteria listed in items (5)(i) and (ii).

262.15(a)(6). Add new item (6) and items (6)(i) through (iii) to adopt language that describes how a generator who accumulates either acute hazardous waste listed in section 261.31 or 261.33(e) or non-acute hazardous waste in excess of the amounts listed in paragraph (a) of this section at or near any point of generation must follow the requirements described in (6)(i) through (iii).

262.15(a)(7). Add new item (7) to adopt language that describes how all satellite accumulation areas operated by a small quantity generator must meet the preparedness and prevention regulations of section 262.16(b)(8) and emergency procedures at 262.16(b)(9).

262.15(a)(8). Add new item (8) to adopt language that describes how all satellite accumulation areas operated by a large quantity generator must meet the Preparedness, Prevention and Emergency Procedures in R.61-79.262 subpart M.

262.15(b). Add and reserve new subsection (b).

262.16. Add new section titled, "Conditions for exemption for a small quantity generator that accumulates hazardous waste." Add new introductory paragraph to adopt language that describes how a small quantity generator may accumulate hazardous waste on site without a permit or interim status, and without complying with the requirements of R.61-79.124, 264 through 266, and 270, or the notification requirements of the SC Hazardous Waste Management Act section 44-56-120 and section 3010 of RCRA, provided that all the conditions for exemption listed in 262.16(a) through (f) are met.

262.16(a). Add new subsection (a) to adopt language that describes how the generator generates in a calendar month no more than the amounts specified in the definition of “small quantity generator” in section 260.10.

262.16(b). Add new subsection (b) to adopt language that describes how the generator accumulated hazardous waste on site for no more than 180 days, unless in compliance with the conditions for exemption for longer accumulation in paragraphs (d) and (e) of this section with accumulation conditions listed in 262.16(b)(1) through (9).

262.16(b)(1). Add new item (1) to adopt language that describes how the accumulation limit of the quantity of hazardous waste on site should never exceed six thousand (6,000) kilograms (13,200 pounds).

262.16(b)(2). Add new item (2) and items (2)(i) through (v) to adopt language to describe the accumulation of hazardous waste in containers requirements for a small quantity generator.

262.16(b)(3). Add new item (3) to adopt language to introduce the conditions for accumulation of hazardous waste in tanks.

262.16(b)(3)(i). Add new item (3)(i) and reserve.

262.16(b)(3)(ii). Add new item (3)(ii) and items (3)(ii)(A) through (D) to adopt language that describes that a small quantity generator of hazardous waste must comply with the general operating conditions described in new items.

262.16(b)(3)(iii). Add new item (3)(iii) and items (3)(iii)(A) through (E) to adopt language that describes that a small quantity generator that accumulates hazardous waste in tanks must inspect, where present, the materials in (3)(iii)(A) through (E).

262.16(b)(3)(iv). Add new item (3)(iv) to adopt language that describes how a small quantity generator accumulating hazardous waste in tanks or tank systems that have full secondary containment and that either use leak detection equipment to alert personnel to leaks, or implement established workplace practices to ensure leaks are promptly identified, must inspect at least weekly, where applicable, the areas identified in 262.16(b)(3)(iii)(A) through (E).

262.16(b)(3)(v). Add new item (3)(v) and reserve.

262.16(b)(3)(vi). Add new item (3)(vi) to adopt language that describes how a small quantity generator accumulating hazardous waste in tanks must, upon closure of the facility, remove all hazardous waste from tanks, discharge control equipment, and discharge confinement structures. At closure, as throughout the operating period, unless the small quantity generator can demonstrate, in accordance with 261.3(c) or (d), that any solid waste removed from its tank is not a hazardous waste, then it must manage such waste in accordance with all applicable provisions of R.61-79.262, 263, 265 and 268.

262.16(b)(3)(vii). Add new item (3)(vii) to adopt language that describes how a small quantity generator must comply with specified special conditions in new items (3)(vii)(A) through (C) for accumulation of ignitable or reactive waste.

262.16(b)(4). Add new item (4) to adopt language that describes how the small quantity generator must comply with the requirements in new items (4)(i) through (iii) if the accumulation of hazardous waste is placed on drip pads.

262.16(b)(5). Add new item (5) to adopt language that describes the required procedures for accumulation of hazardous waste in containment buildings. Add new items (5)(i) and (ii) to adopt language that describes the required records the generator must maintain for accumulation of hazardous waste in containment buildings.

262.16(b)(6). Add new item (6) and items (6)(i) through (ii) to adopt language that describe the requirements for labeling and marking of containers and tanks of accumulated hazardous waste.

262.17(b)(7). Add new item (7) to adopt language that describes how a small quantity generator must comply with all the applicable land disposal restriction requirements under R.61-79.268.

262.16(b)(8). Add new item (8) to adopt language to introduce preparedness and prevention for small quantity generators.

262.16(b)(8)(i). Add new item (8)(i) to adopt language that describes the maintenance and operation of a facility. A small quantity generator must maintain and operate its facility to minimize the possibility of a fire, explosion, or any unplanned sudden or non-sudden release of hazardous waste or hazardous waste constituents to air, soil, or surface water which could threaten human health or the environment.

262.16(b)(8)(ii). Add new item (8)(ii) to adopt language that describes the required equipment for a small quantity generator. All areas where hazardous waste is either generated or accumulated must be equipped with the items described in new items (8)(ii)(A) through (D).

262.16(b)(8)(iii). Add new item (8)(iii) to adopt language that describes the testing and maintenance of required equipment for a small quantity generator. All communications or alarm systems, fire protection equipment, spill control equipment, and decontamination equipment, where required, must be tested and maintained as necessary to assure its proper operation in time of emergency.

262.16(b)(8)(iv). Add new item (8)(iv) to adopt language that describes access to communications or alarm systems for personnel described in new items (8)(iv)(A) and (B).

262.16(b)(8)(v). Add new item (8)(v) to adopt language that describes the required aisle space to allow the unobstructed movement of personnel, fire protection equipment, spill control equipment, and decontamination equipment to any area of facility operation in an emergency, unless aisle space is not needed for any of these purposes.

262.16(b)(8)(vi). Add new item (8)(vi) and new items (8)(vi)(A) through (C) to adopt language that describes the required arrangements with local authorities, including the police department, fire department, and other emergency response teams that small quantity generators must follow.

262.16(b)(9). Add new item (9) to adopt language that describes the emergency procedures for the small quantity generator. The small quantity generator complies with the following conditions described in 262.16(b)(9)(i) through (iv) for those areas of the generator facility where hazardous waste is generated and accumulated.

262.16(b)(9)(i). Add new item (9)(i) to adopt language that describes how at all times there must be at least one employee, who will be designated the emergency coordinator, either on the premises or on call (i.e., available to respond to an emergency by reaching the facility within a short period of time) with the responsibility for coordinating all emergency response measures specified in paragraph (b)(9)(iv) of this section.

262.16(b)(9)(ii). Add new item (9)(ii) to adopt language that describes how the small quantity generator must post the following information in 262.16(b)(9)(ii)(A) through (C) next to telephones or in areas directly involved in the generation and accumulation of hazardous waste: the name and emergency telephone number of the emergency coordinator; location of fire extinguishers and spill control material, and, if present, fire alarm; and the telephone number of the fire department, unless the facility has a direct alarm.

262.16(b)(9)(iii). Add new item (9)(iii) to adopt language that describes how the small quantity generator must ensure that all employees are thoroughly familiar with proper waste handling and emergency procedures, relevant to their responsibilities during normal facility operations and emergencies.

262.16(b)(9)(iv). Add new item (9)(iv) and new items (9)(iv)(A) through (C) to adopt language that describes how the emergency coordinator in a small quantity generator facility or his designee must respond to any emergencies that arise. The applicable responses for each possible emergency are described in 9)(iv)(A) through (C).

262.16(c). Add new subsection (c) to adopt language to describe transporting small quantity waste over two hundred (200) miles. A small quantity generator who must transport its waste, or offer its waste for transportation, over a distance of two hundred (200) miles or more for off-site treatment, storage or disposal may accumulate hazardous waste on site for two hundred seventy (270) days or less without a permit or without having interim status provided that the generator complies with the conditions of paragraph (b) of this section.

262.16(d). Add new subsection (d) to adopt language to describe accumulation time limit extension for the small quantity generator. A small quantity generator who accumulates hazardous waste for more than one hundred eighty (180) days (or for more than two hundred seventy (270) days if it must transport its waste, or offer its waste for transportation, over a distance of two hundred (200) miles or more) is subject to the requirements of R.61-79.264, 265, 268, and 270 of this chapter unless it has been granted an extension to the 180-day (or 270-day if applicable) period. Such extension may be granted by the Department if hazardous wastes must remain on site for longer than one hundred eighty (180) days (or 270 days if applicable) due to unforeseen, temporary, and uncontrollable circumstances. An extension of up to thirty (30) days may be granted at the discretion of the Department on a case-by-case basis.

262.16(e). Add new subsection (e) and items (e)(1) and (2) to adopt language to describe the rejected load requirements for the small quantity generator.

262.16(f). Add new subsection (f) to adopt language to describe how a small quantity generator experiencing an episodic event may accumulate hazardous waste in accordance with subpart L of R.61-79.262 in lieu of section 262.17.

262.17. Add new section titled, "Conditions for exemption for a large quantity generator that accumulates hazardous waste." Add new introductory text to adopt language to describe how a large quantity generator may accumulate hazardous waste on site without a permit or interim status, and without complying with the requirements of R.61-79.124, 264 through 266, and 270, or the notification requirements of section 3010 of RCRA, provided that all of the following conditions for exemption are met in 262.17(a) through (g).

262.17(a). Add new subsection (a) to adopt language that describes accumulation for a large quantity generator. A large quantity generator accumulates hazardous waste on site for no more than ninety (90) days, unless in compliance with the accumulation time limit extension or F006 accumulation conditions for

exemption in paragraphs (b) through (e) of this section. The following accumulation conditions in 262.17(a)(1) through (9) also apply.

262.17(a)(1). Add new item (1) to adopt language that describes accumulation of hazardous waste in containers for large quantity generators. If the hazardous waste is placed in containers, the large quantity generator must comply with the requirements in 262.17(a)(1)(i) through (vii).

262.17(a)(1)(i). Add new item (1)(i) to adopt language that describes air emission standards for large quantity generators. The applicable requirements of subparts AA, BB, and CC of R.61-79.265.

262.17(a)(1)(ii). Add new item (1)(ii) to adopt language that describes the condition of containers for large quantity generators. If a container holding hazardous waste is not in good condition, or if it begins to leak, the large quantity generator must immediately transfer the hazardous waste from this container to a container that is in good condition, or immediately manage the waste in some other way that complies with the conditions for exemption of this section.

262.17(a)(1)(iii). Add new item (1)(iii) to adopt language that describes the compatibility of waste with container for large quantity generators. The large quantity generator must use a container made of or lined with materials that will not react with, and are otherwise compatible with, the hazardous waste to be stored, so that the ability of the container to contain the waste is not impaired.

262.17(a)(1)(iv). Add new item (1)(iv) and new items (1)(iv)(A) and (B) to adopt language that describes the management of containers for large quantity generators.

262.17(a)(1)(v). Add new item (1)(v) to adopt language that describes inspections of large quantity generators. At least weekly, the large quantity generator must inspect central accumulation areas. The large quantity generator must look for leaking containers and for deterioration of containers caused by corrosion or other factors.

262.17(a)(1)(vi). Add new item (1)(vi) and new items (1)(vi)(A) and (B) to adopt language that describes the special conditions for accumulation of ignitable and reactive wastes for large quantity generators.

262.17(a)(1)(vii). Add new item (1)(vii) and items (1)(vii)(A) through (C) to adopt language that describes special conditions for accumulation of incompatible wastes for large quantity generators including: incompatible wastes, or incompatible wastes and materials, must not be placed in the same container, unless in compliance with 265.17(b); hazardous waste must not be placed in an unwashed container that previously held an incompatible waste or material, unless in compliance with 265.17(b); and, a container holding a hazardous waste that is incompatible with any waste or other materials accumulated or stored nearby in other containers, piles, open tanks, or surface impoundments must be separated from the other materials or protected from them by means of a dike, berm, wall, or other device.

262.17(a)(2). Add new item (2) to adopt language that describes accumulation of hazardous waste in tanks. If the waste is placed in tanks, the large quantity generator must comply with the applicable requirements of subpart J, except 265.197(c) of Closure and post-closure care and section 265.200—Waste analysis and trial tests, as well as the applicable requirements of AA, BB, and CC of R.61-79.265.

262.17(a)(3). Add new item (3) and new items (3)(i) through (iii) to adopt language that describes accumulation of hazardous waste on drip pads for large quantity generators. If the hazardous waste is placed on drip pads, the large quantity generator must comply with the requirements described in (a)(3)(i) through (iii).



262.17(a)(4). Add new item (4) to adopt language that describes accumulation of hazardous waste in containment buildings for large quantity generators.

262.17(a)(4)(i). Add new item (4)(i) to adopt language that describes how the large quantity generator must maintain the professional engineer certification that states the building complies with the design standards specified in section 265.1101. This certification must be in the generator's files prior to operation of the unit.

262.17(a)(4)(ii). Add new item (4)(ii) to adopt language that describes how the following records in 262.17(a)(4)(ii)(A) through (C) by use of inventory logs, monitoring equipment, or any other effective means must be maintained by the large quantity generator: a written description of procedures to ensure that each waste volume remains in the unit for no more than ninety (90) days, a written description of the waste generation and management practices for the facility showing that the generator is consistent with respecting the ninety(90) day limit, and documentation that the procedures are complied with; or documentation that the unit is emptied at least once every ninety (90) days; and inventory logs or records with the previous information must be maintained on site and readily available for inspection.

262.17(a)(5). Add new item (5) to adopt language to introduce the labeling and marking of containers and tanks requirements for large quantity generators.

262.17(a)(5)(i). Add new item (5)(i) and new items (5)(i)(A) through (C) to adopt language that describes the required markings or labels a large quantity generator must have on its containers.

262.17(a)(5)(ii). Add new item (5)(ii) and items (5)(ii)(A) through (D) to adopt language that describes the requirements of a large quantity generator accumulating hazardous waste in tanks concerning labeling and marking.

262.17(a)(6). Add new item (6) to adopt language that describes how the large quantity generator must comply with the standards in subpart M of R.61-79.262, Preparedness, Prevention and Emergency Procedures for Large Quantity Generators.

262.17(a)(7). Add new item (7) to adopt language to introduce personnel training requirements for large quantity generators.

262.17(a)(7)(i)(A). Add new item (7)(i)(A) to adopt language that describes how facility personnel must successfully complete a program of classroom instruction, online training (e.g. computer-based or electronic), or on-the-job training that teaches them to perform their duties in a way that ensures compliance with this part. The large quantity generator must ensure that this program includes all the elements described in the document required under paragraph (a)(7)(iv) of this section.

262.17(a)(7)(i)(B). Add new item (7)(i)(B) to adopt language that describes how the personnel training program must be directed by a person trained in hazardous waste management procedures, and must include instruction which teaches facility personnel hazardous waste management procedures (including contingency plan implementation) relevant to the positions in which they are employed.

262.17(a)(7)(i)(C). Add new item (7)(i)(C) and items (7)(i)(C) through (6) to adopt language that describes how, at a minimum, the training program must be designed to ensure that facility personnel are able to respond effectively to emergencies by familiarizing them with emergency procedures, emergency equipment, and emergency systems.

262.17(a)(7)(i)(D). Add new item (7)(i)(D) to adopt language that describes how the large quantity generator is not required to provide separate emergency response training pursuant to this section, provided that the overall facility training meets all the conditions of exemption in this section for facility employees that receive emergency response training pursuant to Occupational Safety and Health Administration regulations.

262.17(a)(7)(ii). Add new item (7)(ii) to adopt language that describes how the facility personnel must successfully complete the program required in paragraph (a)(7)(i) of this section within six (6) months after the date of their employment or assignment to the facility, or to a new position at the facility, whichever is later. Employees must not work in unsupervised positions until they have completed the training standards of paragraph (a)(7)(i) of this section.

262.17(a)(7)(iii). Add new item (7)(iii) to adopt language that describes how the facility personnel must take part in an annual review of the initial training required in paragraph (a)(7)(i) of this section.

262.17(a)(7)(iv). Add new item (7)(iv) and items (7)(iv)(A) through (D) to adopt language that describes how the large quantity generator must maintain the required documents and records, listed in (7)(iv)(A) through (D), at the facility.

262.17(a)(7)(v). Add new item (7)(v) to adopt language that describes how training records on current personnel must be kept until closure of the facility at least three (3) years from the date the employee last worked at the facility.

262.17(a)(8). Add new item (8) to adopt language that describes how a large quantity generator accumulating hazardous wastes in containers, tanks, drip pads, and containment buildings, prior to closing a unit at the facility, or prior to closing the facility must meet the conditions in (8)(i) through (v).

262.17(a)(8)(i). Add new item (8)(i) and items (8)(i)(A) and (B) to adopt language that describes how a large quantity generator must perform one of the requirements described in (8)(i)(A) or (B) for the notification for closure of a waste accumulation unit.

262.17(a)(8)(ii). Add new item (8)(ii) and items (8)(ii)(A) through (C) to adopt language that describes how a large quantity generator must perform one of the requirements described in paragraphs (8)(ii)(A) through (C) when providing notification for closure of the facility.

262.17(a)(8)(iii). Add new item (8)(iii) and items (8)(iii)(A)(1) through (4) to adopt language that describes closure performance standards for container, tank systems, and containment building waste accumulation units.

262.17(a)(8)(iv). Add new item (8)(iv) to adopt language that describes how the generator must comply with the closure performance standards for drip pad waste accumulation units.

262.17(a)(8)(v). Add new item (8)(v) to adopt language that describes how the closure requirements of paragraph (a)(8) of this section do not apply to satellite accumulation areas.

262.17(a)(9). Add new item (9) to adopt language that describes how the large quantity generator must comply with all applicable requirements under R.61-79.268 for land disposal restrictions.

262.17(b). Add new subsection (b) to adopt language that describes how a large quantity generator who accumulates hazardous waste for more than ninety (90) days is subject to the requirements of R.61-79.124, 264 through 268, and 270, and the notification requirements of section 3010 of RCRA, unless it has been

granted an extension to the ninety (90) day period. Such extension may be granted by the Department if hazardous wastes must remain on site for longer than ninety (90) days due to unforeseen, temporary, and uncontrollable circumstances. An extension of up to thirty (30) days may be granted at the discretion of the Department on a case-by-case basis.

262.17(c). Add new subsection (c) and items (c)(1) through (4) to adopt language that describes how a large quantity generator who also generates wastewater treatment sludges from electroplating operations that meet the listing description for the EPA hazardous waste number F006, may accumulate F006 waste on site for more than ninety (90) days, but not more than one hundred eighty (180) days without being subject to R.61-79.124, 264 through 267, and 270, and the notification requirements of section 3010 of RCRA, provided that it complies with all of the additional conditions for exemption listed in paragraphs (c)(1) through (4).

262.17(d). Add new subsection (d) to adopt language that describes how a large quantity generator who also generates wastewater treatment sludges from electroplating operations that meet the listing description for the EPA hazardous waste number F006, and who must transport this waste, or offer this waste for transportation, over a distance of two hundred (200) miles or more for off-site metals recovery, may accumulate F006 waste on site for more than ninety (90) days, but not more than two hundred seventy (270) days without being subject to R.61-79.124, 264 through 267, 270, and the notification requirements of section 3010 of RCRA, if the large quantity generator complies with all of the conditions for exemption of paragraphs (c)(1) through (4) of this section.

262.17(e). Add new subsection (e) to adopt language that describes how a large quantity generator accumulating F006 in accordance with paragraphs (c) and (d) of this section who accumulates F006 waste on site for more than one hundred eighty (180) days (or for more than two hundred seventy (270) days if the generator must transport this waste, or offer this waste for transportation, over a distance of two hundred (200) miles or more), or who accumulates more than twenty thousand kilograms (20,000 kg) of F006 waste on site is an operator of a storage facility and is subject to the requirements of R.61-79.124, 264, 265, and 270, and the notification requirements of section 3010 of RCRA, unless the generator has been granted an extension to the 180-day (or 270-day if applicable) period or an exception to the 20,000 kg accumulation limit.

262.17(f). Add new subsection (f) and items (f)(1) through (3) to adopt language that describes how large quantity generators may accumulate on site hazardous waste received from very small quantity generators under control of the same person (as defined in section 260.10), without a storage permit or interim status and without complying with the requirements of R.61-79.124, 264 through 268, and 270, and the notification requirements of section 3010 of RCRA, provided that they comply with the conditions described in paragraphs (f)(1) through (3).

262.17(g). Add new subsection (g) and items (g)(1) and (2) to adopt language that describes how a large quantity generator who sends a shipment of hazardous waste to a designated facility with the understanding that the designated facility can accept and manage the waste and later receives that shipment back as a rejected load or residue in accordance with the manifest discrepancy provisions of section 264.72 or 265.72 may accumulate the returned waste on site in accordance with paragraphs (a) and (b) of this section Upon receipt of the returned shipment, the generator must follow one of the requirements in (g)(1) or (2).

262.18. Add new section titled, "EPA identification numbers and re-notification for small quantity generators and large quantity generators."

262.18(a). Add new subsection (a) to adopt language that describes how a generator must not treat, store, dispose of, transport, or offer for transportation, hazardous waste without having received an EPA identification number from the Department.

262.18(b). Add new subsection (b) to adopt language that describes how a generator who has not received an EPA identification number must obtain one by applying to the Department using EPA Form 8700-12. Upon receiving the request, the Department will assign an EPA identification number to the generator.

262.18(c). Add new subsection (c) to adopt language that describes how a generator must not offer its hazardous waste to transporters or to treatment, storage, or disposal facilities that have not received an EPA identification number.

262.18(d). Add new subsection (d) to adopt language that describes the re-notification process. For small quantity generators, listed in 262.18(d)(1), the generator must re-notify the Department starting in 2021 and every four years thereafter using EPA Form 8700-12, which must be submitted by September 1<sup>st</sup> of each year in which re-notifications are required. For large quantity generators, listed in 262.18(d)(2), the generator must re-notify the Department by March 1<sup>st</sup> of each even-numbered year thereafter using EPA Form 8700-12. A large quantity generator may submit the re-notification as part of its Biennial Report required under section 262.41.

262.18(e). Add new subsection (e) to adopt language that describes how a recognized trader must not arrange for import or export of hazardous waste without having received an EPA identification number from the Department.

262 Subpart B. Revise subpart title to read, “Manifest Requirements Applicable to Small and Large Quantity Generators.”

262 Subpart C. Revise subpart title to read, “Pre-Transport Requirements Applicable to Small and Large Quantity Generators.”

262.32(b). Revise subsection to remove “or offering hazardous waste”. Revise subsection (b) to change punctuation at the end of the paragraph from “.” to “:.” Add numerals 262.32(b)(1) through (4) to existing items. Add new item (b)(5) to adopt language to state the EPA Hazardous Waste Number(s) must be included on a container of one hundred nineteen (119) gallons or less used in transportation of hazardous waste off-site.

262.32(c). Add new subsection (c) to adopt language that describes how a generator may use a nationally recognized electronic system, such as bar coding, to identify the EPA Hazardous Waste Number(s), as required by paragraph (b)(5) or (d).

262.32(d). Add new subsection (d) to adopt language that describes how lab packs that will be incinerated in compliance with 268.42(c) are not required to be marked with EPA Hazardous Waste Number(s), except D004, D005, D006, D007, D008, D010, and D011, where applicable.

262.34. Remove and reserve section.

262.35. Revise section to add section title, “Liquids in landfills prohibition.” Revise section to add new introductory paragraph to read, “The placement of bulk or non-containerized liquid hazardous waste or hazardous waste containing free liquids (whether or not sorbents have been added) in any landfill is prohibited. Prior to disposal in a hazardous waste landfill, liquids must meet additional requirements as specified in sections 264.314 and 265.314.”

262 Subpart D. Revise subpart title to read, “Recordkeeping and Reporting Applicable to Small and Large Quantity Generators.”

262.40(c). Revise subsection to read, “See ~~section~~ R.61-79.262.11(f) for recordkeeping requirements for documenting hazardous waste determinations.”

262.41(b). Revise subsection to remove “262.56.”

262.41(c). Revise subsection to read, “Exports of hazardous waste to foreign countries are not required to be reported on the Biennial Report form. A separate annual report requirement is set forth at section 262.83(g) for hazardous waste exporters.”

262.43. Revise section to add introductory text to read “The Department may require generators to furnish additional reports concerning the quantities and disposition of wastes identified or listed in R.61-79.261.”

262.44. Revise section title to read, “Recordkeeping for small quantity generators.” Revise introductory text to read, “A small quantity generator is subject only to the following independent requirements of this subpart.”

262.200. Remove definition for “Central Accumulation Area.” Revise definition for “Trained professional” to replace: “265.16” with “R.61-79.262.17,” “262.34(d)(5)(iii)” with “R.61-79.262.16,” and “conditionally exempt” with “very.”

262.201. Revise 262.201(a) and (b) to clarify cross references.

262.202(a) and (b). Revise item to clarify cross references.

262.203(a). Revise subsection to clarify eligible academic entity requirements.

262.203(b)(2). Revise item to replace “conditionally exempt” with “very.”

262.204(a). Revise subsection for clarification.

262.204(b)(2) Revise item to replace “conditionally exempt” with “very.”

262.206(b)(3)(iii). Revise item to remove the period after “necessary” and add a colon.

262.207(d)(2). Revise item to add “(a) through (d)” after “262.11.”

262.208(a). Revise subsection to replace “6” with “12” before “months” in items (1) and (2).

262.208(d)(2). Revise item to read, “If a laboratory accumulates more than 1 quart of liquid reactive acutely hazardous unwanted material or more than one (1) kilogram (2.2 pounds) of solid reactive acutely hazardous unwanted material before the regularly scheduled removal, then the eligible academic entity must ensure that all containers of reactive acutely hazardous unwanted material:”

262.208(d)(2)(i). Revise item to insert “or 1 kg” after “1 quart.”

262.208(d)(2)(ii). Revise item to insert “or 1 kg” after “1 quart.”

262.209(b). Revise subsection to clarify.

262.210(a). Revise subsection to insert “(a) through (d)” after “262.11”.

262.210(b)(3). Revise item to replace “status” with “category” and “261.5(c) and (d)” with “R.61-79.262.13.”

262.210(d)(2). Revise item to replace “Conditionally exempt” with “Very” and “261.5(f)(3) for acute hazardous waste, or 261.5(g)(3) for hazardous waste” with “R.61-79.262.14.”

262.211(c). Revise subsection to replace “262.34(a)” with “R.61-79.262.16,” “large” with “small,” “262.34(d)” with “R.61-79.262.17,” “small” with “large,” and “262.34(a)(3)” with “sections 262.16(b)(6) and 262.17(a)(5).”

262.211(d). Revise subsection to insert “(a) through (d)” after “262.11.”

262.211(e)(3). Revise item to replace “status” with “category” and “261.5(c) and (d)” with “R.61-79.262.13.”

262.212(d). Revise subsection to insert “(a) through (d)” after “262.11.”

262.213(a)(1). Revise item to insert “liquid” after “or one (1) quart of,” and “or one (1) kilogram of solid reactive acutely hazardous unwanted material” after “reactive acutely hazardous unwanted material,” anywhere it appears in the item.

262.213(a)(2). Revise item to replace “status” with “category” and “261.5(c) and (d)” with “R.61-79.262.13” anywhere it appears in the item.

262.213(a)(3). Revise item to replace “status” with “category,” “conditionally exempt” with “very,” and “261.5” with “R.61-79.260.10.” Insert “non-acute” after “more than one hundred (100) kilograms per month of.”

262.213(b)(2). Revise item to replace “status” with “category” and “261.5(c) and (d)” with “R.61-79.262.13.”

262.214(b)(5). Revise item to insert “(a) through (d)” after “standards at R.61-79.262.11” and “R.61-79.” before “262.209.”

262.216(a). Revise subsection to replace “262.34(c)” with “262.15.”

262.216(b). Revise subsection to replace “261.5(b)” with “section 262.14” and “conditionally exempt” with “very.”

262 Subpart L. Add new subpart titled, “Alternative Standards for Episodic Generation.”

262.230. Add new section title to read, “Applicability.” Add introductory text to adopt language that describes how this subpart is applicable to very small quantity generators and small quantity generators as defined in section 260.10 of this chapter.

262.231. Add new section title to read, “Definitions for this subpart.” Add, in alphabetical order, the following new definitions: “Episodic event,” “Planned episodic event,” and “Unplanned episodic event.”

262.232. Add new section title to read, “Conditions for a generator managing hazardous waste from an episodic event.”

262.232(a). Add new subsection (a) to adopt language that describes how a very small quantity generator may maintain its existing generator category for hazardous waste generated during an episodic event provided that the generator complies with the conditions in 262.232(a)(1) through (7).

262.232(a)(1). Add new item (1) to adopt language that describes how the very small quantity generator is limited to one episodic event per calendar year, unless a petition is granted under R.61-79.262.233, in order to maintain its existing generator category for hazardous waste generated.

262.232(a)(2). Add new item (2) to adopt language that describes the notification requirement for very small quantity generators prior to initiating a planned episodic event and in the event of an unplanned episodic event.

262.232(a)(3). Add new item (3) to adopt language that describes how the very small quantity generator must have an EPA identification number or obtain an EPA identification number using EPA Form 8700-12 in order to maintain its existing generator category.

262.232(a)(4). Add new item (4) and items (4)(i) through (iii) to adopt language that describes how a very small quantity generator is prohibited from accumulating hazardous waste generated from an episodic event on drip pads and in containment buildings. When accumulating hazardous waste in containers and tanks, the generator must follow the conditions described in (a)(4)(i) through (iii).

262.232(a)(5). Add new item (5) to adopt language that describes how the very small quantity generator must comply with the hazardous waste manifest provisions of subpart B of this part when it sends its episodic event hazardous waste off site to a designated facility, as defined in section 260.10 of this chapter.

262.232(a)(6). Add new item (6) to adopt language that describes how the very small quantity generator has up to sixty (60) calendar days from the start of the episodic event to manifest and send its hazardous waste generated from the episodic event to a designated facility, as defined in section 260.10 of this chapter.

262.232(a)(7). Add new item (7) and items (7)(i) through (vi) to adopt language that describes how very small quantity generators must maintain records listed in (a)(7)(i) through (vi), for three (3) years from the end date of the episodic event.

262.232(b). Add new subsection (b) to adopt language that describes how a small quantity generator may maintain its existing generator category during an episodic event provided that the generator complies with the conditions in 262.232(b)(1) through (6).

262.232(b)(1). Add new item (1) to adopt language that describes how the small quantity generator is limited to one episodic event per calendar year unless a petition is granted under section 262.233 in order to maintain its existing generator category during an episodic event.

262.232(b)(2). Add new item (2) to adopt language that describes how the small quantity generator must notify the Department no later than thirty (30) calendar days prior to initiating a planned episodic event using EPA Form 8700-12 in order to maintain its existing generator category during an episodic event. In the event of an unplanned episodic event, the small quantity generator must notify the Department within 72 hours of the unplanned event via phone, email, or fax, and subsequently submit EPA Form 8700-12. The small quantity generator shall include the start date and end date of the episodic event and the reason(s)

for the event, types and estimated quantities of hazardous wastes expected to be generated as a result of the episodic event, and identify a facility contact and emergency coordinator with 24-hour telephone access to discuss the notification submittal or respond to emergency.

262.232(b)(3). Add new item (3) to adopt language that describes how the small quantity generator must have an EPA identification number or obtain an EPA identification number using EPA Form 8700-12.

262.232(b)(4). Add new item (4) and items (4)(i) and (ii) to adopt language that describes how a small quantity generator is prohibited from accumulating hazardous wastes generated from an episodic event waste on drip pads and in containment buildings. When accumulating hazardous waste generated from an episodic event in containers and tanks, the conditions listed in (b)(4)(i) and (ii) apply.

262.232(b)(5). Add new item (5) to adopt language that describes how the small quantity generator must treat hazardous waste generated from an episodic event on site or manifest and ship such hazardous waste off site to a designated facility (as defined by 260.10) within sixty (60) calendar days from the start of the episodic event.

262.232(b)(6). Add new item (6) to adopt language that describes how the small quantity generator must maintain the following records, listed (b)(6)(i) through (vi), for three (3) years from the end date of the episodic event.

262.233. Add new section title to read, "Petition to manage one additional episodic event per calendar year."

262.233(a). Add new subsection (a) and items (a)(1) and (2) to adopt language that describes how a generator may petition the Department for a second episodic event in a calendar year without impacting its generator category under the conditions described in 262.233(a)(1) and (2).

262.233(b). Add new subsection (b) and items (b)(1) through (5) to adopt language that describes how the generator's petition must include the requirements listed in (b)(1) through (5).

262.233(c). Add new subsection (c) to adopt language that describes how the petition must be made to the Department in writing, either on paper or electronically.

262.233(d). Add new subsection (d) to adopt language that describes how the generator must retain written approval in its records for three (3) years from the date the episodic event ended.

262 Subpart M. Add new subpart titled, "Preparedness, Prevention, and Emergency Procedures for Large Quantity Generators."

262.250. Add new section titled, "Applicability." Add new introductory text to adopt language that describes how the regulation of subpart M applies to those areas of a large quantity generator where hazardous waste is generated or accumulated on site.

262.251. Add new section titled, "Maintenance and operation of facility." Add new introductory text to adopt language that describes how a large quantity generator must maintain and operate its facility to minimize the possibility of a fire, explosion, or any unplanned sudden or non-sudden release of hazardous waste or hazardous waste constituents to air, soil, or surface water which could threaten human health or environment.



262.252. Add new section titled, "Required equipment." Add new introductory text and subsections (a) through (d) to adopt language that describes how all areas deemed applicable by section 262.250 must be equipped with the items in paragraphs (a) through (d) of this section (unless none of the hazards posed by waste handled at the facility could require a particular kind of equipment specified below or the actual hazardous waste generation or accumulation area does not lend itself for safety reasons to have a particular kind of equipment specified below).

262.253. Add new section titled, "Testing and maintenance of equipment." Add new introductory text to adopt language that describes how all communications or alarm systems, fire protection equipment, spill control equipment, and decontamination equipment, where required, must be tested and maintained as necessary to assure its proper operation in time of emergency.

262.254. Add new section titled, "Access to communications or alarm system."

262.254(a). Add new subsection (a) to adopt language that describes how all personnel involved in the operation of pouring, mixing, spreading, or otherwise handling hazardous waste must have immediate access (e.g., direct or unimpeded access) to an internal alarm or emergency communication device, either directly or through visual or voice contact with another employee, unless such a device is not required under section 262.252.

262.254(b). Add new subsection (b) to adopt language that describes how the employee must have immediate access (e.g., direct or unimpeded access) to a device, such as a telephone (immediately available at the scene of operation) or a hand-held two-way radio, capable of summoning external emergency assistance, unless such a device is not required under section 262.252 in the event there is only one employee on the premises while the facility is operating.

262.255. Add new section titled, "Required aisle space." Add new introductory text to adopt language that describes how the large quantity generator must maintain aisle space to allow the unobstructed movement of personnel, fire protection equipment, spill control equipment, and decontamination equipment to any area of facility operation in an emergency, unless aisle space is not needed for any of these purposes.

262.256. Add new section titled, "Arrangements with local authorities."

262.256(a). Add new subsection (a) to adopt language that describes how the large quantity generator must attempt to make arrangements with the local police department, fire department, other emergency response teams, emergency response contractors, equipment suppliers, and local hospitals, taking into account the types and quantities of hazardous wastes handled at the facility. Arrangements may be made with the Local Emergency Planning Committee, if it is determined to be the appropriate organization with which to make arrangements.

262.256(a)(1). Add new item (1) to adopt language that describes how a large quantity generator attempting to make arrangements with its local fire department must determine the potential need for the services of the local police department, other emergency response teams, emergency response contractors, equipment suppliers, and local hospitals.

262.256(a)(2). Add new item (2) to adopt language that describes how the large quantity generator shall attempt to make arrangements, as necessary, to familiarize the above organizations with the layout of the facility, the properties of the hazardous waste handled at the facility and associated hazards, places where personnel would normally be working, entrances to roads inside the facility, and possible evacuation routes as well as the types of injuries or illnesses which could result from fires, explosions, or releases at the facility as part of coordination with local authorities.

262.256(a)(3). Add new item (3) to adopt language that describes how the large quantity generator shall attempt to make arrangements designating primary emergency authority to a specific fire or police department, and arrangements with any others to provide support to the primary emergency authority where more than one police or fire department might respond to an emergency.

262.256(b). Add new subsection (b) to adopt language that describes how the large quantity generator shall maintain records documenting the arrangements with the local fire department as well as any other organization necessary to respond to an emergency. This documentation must include documentation in the operating record that either confirms such arrangements actively exist or, in cases where no arrangements exist, confirms that attempts to make such arrangements were made.

262.256(c). Add new subsection (c) to adopt language that describes how a facility possessing 24-hour response capabilities may seek a waiver from the authority having jurisdiction (AHJ) over the fire code within the facility's state or locality as far as needing to make arrangements with the local fire department as well as any other organization necessary to respond to an emergency, provided that the waiver is documented in the operating record.

262.260. Add new section titled, "Purpose and implementation of contingency plan."

262.260(a). Add new subsection (a) to adopt language that describes how a large quantity generator must have a contingency plan for the facility. The contingency plan must be designed to minimize hazards to human health or the environment from fires, explosions, or any unplanned sudden or non-sudden release of hazardous waste or hazardous waste constituents to air, soil, or surface water.

262.260(b). Add new subsection (b) to adopt language that describes how the provisions of the plan must be carried out immediately whenever there is a fire, explosion, or release of hazardous waste or hazardous waste constituents which could threaten human health or the environment.

262.261. Add new section titled, "Content of contingency plan."

262.261(a). Add new subsection (a) to adopt language that describes how the contingency plan must describe the actions facility personnel must take to comply with sections 262.260 and 262.265 in response to fires, explosions, or any unplanned sudden or non-sudden release of hazardous waste or hazardous waste constituents to air, soil, or surface water at the facility.

262.261(b). Add new subsection (b) to adopt language that describes how the generator need only amend the Spill Prevention, Control, and Countermeasures (SPCC) Plan in accordance with part 112 of this chapter or some other emergency or contingency plan to incorporate hazardous waste management provisions that are sufficient to comply with the standards of this part.

262.261(c). Add new subsection (c) to adopt language that describes how the plan must describe arrangements agreed to with the local police department, fire department, other emergency response teams, emergency response contractors, equipment suppliers, local hospitals or, if applicable, the Local Emergency Planning Committee, pursuant to section 262.256.

262.261(d). Add new subsection (d) to adopt language that describes how the plan must list names and emergency telephone numbers of all persons qualified to act as emergency coordinator (see section 262.264), and this list must be kept up to date. Where more than one person is listed, one must be named as primary emergency coordinator and others must be listed in the order in which they will assume responsibility as alternates. In situations where the generator facility has an emergency coordinator

continuously on duty because it operates 24 hours per day, every day of the year, the plan may list the staffed position (e.g., operations manager, shift coordinator, shift operations supervisor) as well as an emergency telephone number that can be guaranteed to be answered at all times.

262.261(e). Add new subsection (e) to adopt language that describes how the plan must include a list of all emergency equipment at the facility (such as fire extinguishing systems, spill control equipment, communications and alarm systems (internal and external), and decontamination equipment), where this equipment is required. This list must be kept up to date. In addition, the plan must include the location and a physical description of each item on the list, and a brief outline of its capabilities.

262.261(f). Add new subsection (f) to adopt language that describes how the plan must include an evacuation plan for generator personnel where there is a possibility that evacuation could be necessary. This plan must describe signal(s) to be used to begin evacuation, evacuation routes, and alternate evacuation routes (in cases where the primary routes could be blocked by releases of hazardous waste or fires).

262.262. Add new section titled, "Copies of contingency plan." Add new introductory text to adopt language that describes how a copy of the contingency plan and all revisions to the plan must be maintained at the large quantity generator and follow 262.262(a) through (c).

262.262(a). Add new subsection (a) to adopt language that describes how the large quantity generator must submit a copy of the contingency plan and all revisions to all local emergency responders (i.e., police departments, fire departments, hospitals, and state and local emergency response teams that may be called upon to provide emergency services). This document may also be submitted to the Local Emergency Planning Committee, as appropriate.

262.262(b). Add new subsection (b) and items (b)(1) through (8) to adopt language that describes how a large quantity generator that first becomes subject to these provisions after May 30, 2017 or a large quantity generator that is otherwise amending its contingency plan must at that time submit a quick reference guide, which must contain the requirements listed in (b)(1) through (8), of the contingency plan to the local emergency responders identified at paragraph (a) of this section or, as appropriate, the Local Emergency Planning Committee.

262.262(c). Add new subsection (c) to adopt language that describes how generators must update, if necessary, their quick reference guides, whenever the contingency plan is amended and submit these documents to the local emergency responders identified at paragraph (a) of this section or, as appropriate, the Local Emergency Planning Committee.

262.263. Add new section titled, "Amendment of contingency plan." Add new introductory text and subsections (a) through (e) to adopt language that describes how the contingency plan must be reviewed, and immediately amended, if necessary, whenever the following applies, listed in (a) through (e): applicable regulations are revised; the plan fails in an emergency; the generator facility changes in a way that materially increases the potential for fires, explosions, or releases of hazardous waste constituents, or changes the response necessary in an emergency; the list of emergency coordinators changes; or the list of emergency equipment changes.

262.264. Add new section titled, "Emergency coordinator." Add new introductory text to adopt language that describes how there must be at least one employee either on the generator's premises or on call with the responsibility for coordinating all emergency response measures and implementing the necessary emergency procedures outlined in section 262.265 at all times. Although responsibilities may vary depending on factors such as type and variety of hazardous waste(s) handled by the facility, as well as type and complexity of the facility, this emergency coordinator must be thoroughly familiar with all aspects of

the generator's contingency plan, all operations and activities at the facility, the location and characteristics of hazardous waste handled, the location of all records within the facility, and the facility's layout. In addition, this person must have the authority to commit the resources needed to carry out the contingency plan.

262.265. Add new section titled, "Emergency procedures."

262.265(a). Add new subsection (a) and items (a)(1) and (2) to adopt language that describes how whenever there is an imminent or actual emergency situation, the emergency coordinator (or his designee when the emergency coordinator is on call) must immediately do the requirements in (a)(1) and (2): activate internal facility alarms or communication systems, where applicable, to notify all facility personnel; and notify appropriate state or local agencies with designated response roles if their help is needed.

262.265(b). Add new subsection (b) to adopt language that describes how whenever there is a release, fire, or explosion, the emergency coordinator must immediately identify the character, exact source, amount, and areal extent of any released materials. The emergency coordinator may do this by observation or review of the facility records or manifests and, if necessary, by chemical analysis.

262.265(c). Add new subsection (c) to adopt language that describes how concurrently, the emergency coordinator must assess possible hazards to human health or the environment that may result from the release, fire, or explosion. This assessment must consider both direct and indirect effects of the release, fire, or explosion (e.g., the effects of any toxic, irritating, or asphyxiating gases that are generated, or the effects of any hazardous surface water run-offs from water or chemical agents used to control fire and heat-induced explosions).

262.265(d). Add new subsection (d) and items (1) and (2) to adopt language that describes how if the emergency coordinator determines that the facility has had a release, fire, or explosion which could threaten human health or the environment, outside the facility, the emergency coordinator must report the findings described in (d)(1) and (2).

262.265(e). Add new subsection (e) to adopt language that describes how the emergency coordinator must take all reasonable measures necessary to ensure that fires, explosions, and releases do not occur, recur, or spread to other hazardous waste at the generator's facility during an emergency. These measures must include, where applicable, stopping processes and operations, collecting and containing released hazardous waste, and removing or isolating containers.

262.265(f). Add new subsection (f) to adopt language that describes how the emergency coordinator must monitor for leaks, pressure buildup, gas generation, or ruptures in valves, pipes, or other equipment, wherever this is appropriate if the generator stops operations in response to a fire, explosion, or release.

262.265(g). Add new subsection (g) to adopt language that describes how immediately after an emergency, the emergency coordinator must provide for treating, storing, or disposing of recovered waste, contaminated soil or surface water, or any other material that results from a release, fire, or explosion at the facility. Unless the generator can demonstrate, in accordance with 261.3(c) or (d) of this chapter, that the recovered material is not a hazardous waste, then it is a newly generated hazardous waste that must be managed in accordance with all the applicable requirements and conditions for exemption in R.61-79.262, 263, and 265.

262.265(h). Add new subsection (h) and items (h)(1) and (2) to adopt language that describes how the emergency coordinator must ensure that, in the affected area(s) of the facility no hazardous waste that may be incompatible with the release material is treated, stored, or disposed of until cleanup procedures are

completed, and all emergency equipment listed in the contingency plan is cleaned and fit for its intended use before operations are resumed.

262.265(i). Add new subsection (i) and items (i)(1) through (6) to adopt language that describes how the generator must note in the operating record the time, date, and details of any incident that requires implementing the contingency plan. Within fifteen (15) days after the incident, the generator must submit a written report on the incident to the Department that includes the requirements listed in (i)(1) through (6).

263.12. Revise introductory text to add alphanumeric (a) and for clarification.

263.12(b). Add new subsection (b) and items (b)(1) and (2) to adopt language that describes how when consolidating the contents of two or more containers with the same hazardous waste into a new container, or when combining and consolidating two different hazardous wastes that are compatible with each other, the transporter must mark its containers of 119 gallons or less with the words “Hazardous Waste”; and the applicable EPA hazardous waste number(s) (EPA hazardous waste codes) in subparts C and D of R.61-79.261, or in compliance with 262.32(c).

264.1(g)(1). Revise item to replace “261.5” with “R.61-79.261.14.”

264.1(g)(3). Revise item to replace “262.34” with “262.14, 262.15, 262.16, or 262.17.”

264.15(b)(4). Revise item to insert text at the end to read, “R.61-79.270 requires the inspection schedule to be submitted with part B of the permit application. The Department will evaluate the schedule along with the rest of the application to ensure that it adequately protects human health and the environment. As part of this review, the Department may modify or amend the schedule as may be necessary.” Remove comment for 264.15(b)(4).

264.71(c). Revise item to insert text at the end to read, “The provisions of sections 262.15, 262.16, and 262.17 are applicable to the on-site accumulation of hazardous wastes by generators. Therefore, the provisions of sections 262.15, 262.16, and 262.17 only apply to owners or operators who are shipping hazardous waste which they generated at that facility or operating as a large quantity generator consolidating hazardous waste from very small quantity generators under 262.17(f).” Remove comment to 264.71(c).

264.174. Revise section to read, “At least weekly, the owner or operator must inspect areas where containers are stored. The owner or operator must look for leaking containers and for deterioration of containers and the containment system caused by corrosion or other factors. See sections 264.15(c) and 264.171 for remedial action required if deterioration or leaks are detected.”

264.1030(b)(2). Revise item to replace “262.34(a)” with “R.61-79.262.17.”

264.1050(b)(3). Revise item to replace “262.34(a)” with “R.61-79.262.17.”

265.1(c)(5). Revise item to replace “261.5 of this chapter” with “R.61-79.262.14.”

265.1(c)(7). Revise item to read, “A generator accumulating waste onsite in compliance with applicable conditions for exemption in R.61-79.262.14 through 262.17, and R.61-79.262 subparts K and L, except to the extent the requirements of R.61-79.262 are included in those sections and subparts.”

265.71(c). Revise subsection to insert text at the end to read, “The provisions of R.61-79.262.15, 262.16, and 262.17 are applicable to the on-site accumulation of hazardous wastes by generators. Therefore, the

provisions of R.61-79.262.15, 262.16, and 262.17 only apply to owners or operators who are shipping hazardous waste which they generated at that facility or operating as a large quantity generator consolidating hazardous waste from very small quantity generators under 262.17(f).” Remove comment for 265.71(c).

265.174. Revise text to remove phrase “and the containment system.” Insert new sentence at the end to read, “See R.61-79.265.171 for remedial action required if deterioration or leaks are detected.” Remove comment for 265.174.

265.201. Remove and reserve section.

265.1030(b)(2) and (b)(3). Revise items to replace “262.34(a)” with “R.61-79.262.17.”

265.1050(b)(2) and (b)(3). Revise items to replace “262.34(a)” with “R.61-79.262.17.”

266.255(a). Revise subsection to replace “R.61-79.262.34” with “R.61-79.262.16 or 262.17.”

268.1(e)(1). Revise item to read, “Wastes generated by very small quantity generators, as defined in R.61-79.260.10.”

268.7(a)(5). Revise item to replace “262.34” with “R.61-79.262.15, 262.16, and 262.17.”

268.50(a)(1). Revise item to replace clarify new section references.

268.50(a)(2)(i). Revise item to remove “the date each period of accumulation begins;” and insert “with:.”

268.50(a)(2)(i)(A). Add new item (2)(i)(A) to adopt language that describes how each container of hazardous waste is clearly marked with the words “Hazardous Waste.”

268.50(a)(2)(i)(B). Add new item (2)(i)(B) to adopt language that describes how each container of hazardous waste is clearly marked with the applicable EPA hazardous waste number(s) (EPA hazardous waste codes) in subparts C and D of R.61-79.261; or use a nationally recognized electronic system, such as bar coding, to identify the EPA hazardous waste number(s).

268.50(a)(2)(i)(C). Add new item (2)(i)(C) to adopt language that describes how each container of hazardous waste is clearly marked with an indication of the hazards of the contents (examples include, but are not limited to, the applicable hazardous waste characteristics(s) (i.e., ignitable, corrosive, reactive, toxic); hazard communication consistent with the Department of Transportation requirements at 49 CFR part 172 subpart E (labeling) or subpart F (placarding); a hazard statement or pictogram consistent with the Occupational Safety and Health Administration Hazard Communication Standard at 29 CFR 1910.1200; or a chemical hazard label consistent with the National Fire Protection Association code 704).

268.50(a)(2)(i)(D). Add new item (2)(i)(D) to adopt language that describes how each container of hazardous waste is clearly marked with the date each period of accumulation begins.

270.1(a)(3). Revise item to read, “Technical regulations. The RCRA permit program has separate additional regulations that contain technical requirements. These separate regulations are used by permit issuing authorities to determine what requirements must be placed in permits if they are issued. These separate regulations are located in R.61-79.264, 266, 267, and 268.”

270.1(c)(2). Revise item to insert “and exemptions” after “Specific exclusions” and “RCRA” before “permit.”

270.1(c)(2)(i). Revise item to read, “Generators who accumulate hazardous waste onsite in compliance with all of the conditions for exemption provided in R.61-79.262.14, 262.15, 262.16, and 262.17.”

270.1(c)(2)(iii). Revise item to read, “Persons who own or operate facilities solely for the treatment, storage or disposal of hazardous waste excluded from regulations under this Part by R.61-79.261.4 or 261.14 (very small quantity generator exemption).”

270.42(l). Revise subsection to reserve it.

270.42 Appendix I to 270.42 Section O. Revise section to remove and reserve O.1.

273.8. Revise section title to read, “Applicability—household and very small quantity generator waste.”

273.8(a)(2). Revise item to replace “Conditionally exempt” with “Very,” and “261.5” with “261.14.”

273.81(b). Revise subsection to replace “conditionally exempt” with “very.”

### **Notice of Public Hearing and Opportunity for Public Comment:**

Interested persons may submit written comment(s) on the proposed amendment by mail to David Scaturro in the Bureau of Land and Waste Management at the S.C. Department of Health and Environmental Control, 2600 Bull Street, Columbia, S.C. 29201; fax at (803) 898-0590; or email at [scaturd@dhec.sc.gov](mailto:scaturd@dhec.sc.gov). To be considered, the Department must receive the comment(s) by 5:00 p.m. on November 26, 2018, the close of the comment period.

The S.C. Board of Health and Environmental Control will conduct a public hearing on the proposed amendment during its December 13, 2018, 10:00 a.m. meeting. Interested persons may make oral and/or submit written comments at the public hearing. Persons making oral comments should limit their statements to five (5) minutes or less. The meeting will take place in the Board Room of the DHEC Building, located at 2600 Bull Street, Columbia, S.C. 29201. Due to admittance procedures, all visitors must enter through the main Bull Street entrance and register at the front desk. The Department will publish a meeting agenda twenty-four (24) hours in advance indicating the order of its scheduled items at: <http://www.scdhec.gov/Agency/docs/AGENDA.PDF>.

The Department publishes a Monthly Regulation Development Update tracking the status of its proposed new regulations, amendments, and repeals and providing links to associated State Register documents at <http://www.scdhec.gov/Agency/RegulationsAndUpdates/RegulationDevelopmentUpdate/>.

### **Preliminary Fiscal Impact Statement**

The proposed amendments have no substantial fiscal or economic impact on the state or its political subdivisions. Implementation of this regulation will not require additional resources beyond those allowed. There is no anticipated additional cost by the Department or state Government due to any requirements of this regulation.

## **Statement of Need and Reasonableness**

The following presents an analysis of the factors listed in 1976 Code Section 1-23-115(C)(1)-(3) and (9)-(11):

DESCRIPTION OF REGULATION: 61-79, Hazardous Waste Management Regulations

Purpose: The purpose of this amendment is to realize the benefits of and maintain state consistency with the EPA's November 28, 2016, amendments to 40 CFR 260 through 279.

Legal Authority: 1976 Code Section 44-56-30

Plan for Implementation: The DHEC Regulation Development Update (accessible at <http://www.scdhec.gov/Agency/RegulationsAndUpdates/RegulationDevelopmentUpdate/>) provides a summary of and link to this proposed amendment. Additionally, printed copies are available for a fee from the Department's Freedom of Information Office. Upon taking legal effect, Department personnel will take appropriate steps to inform the regulated community of the amendment and any associated information.

### **DETERMINATION OF NEED AND REASONABLENESS OF THE PROPOSED REGULATION BASED ON ALL FACTORS HEREIN AND EXPECTED BENEFITS:**

The Department proposes amending R.61-79 to adopt the EPA's Hazardous Waste Generator Improvements Rule, published on November 28, 2016, at 81 FR 85732-85829. The rule amends the existing hazardous waste generator regulatory program by reorganizing the hazardous waste generator regulations to improve their usability by the regulated community. This rule clarifies how the RCRA hazardous waste generator regulatory program works and addresses gaps in the existing regulations to strengthen environmental protections. This rule provides greater flexibility for generators to manage hazardous waste in a cost-effective and protective manner, and makes technical corrections and changes to address inadvertent errors and remove outdated references to programs that no longer exist. While the majority of the rule is equivalent to current state regulations and optional for state adoption, several provisions are more stringent and must be adopted by the Department to maintain federal program authorization. Due to the interrelated nature of the equivalent provisions and the more stringent provisions, the Department proposes adopting the rule in a single drafting that requires General Assembly review.

### **DETERMINATION OF COSTS AND BENEFITS:**

There is no anticipated increased cost to the state or its political subdivisions resulting from this proposed revision. There will likely be a slight increase in costs to the regulated community for compliance from this proposed revision. The amendments to R.61-79 will reorganize the hazardous waste generator regulations to improve their usability by the regulated community, provide a better understanding of how the RCRA hazardous waste generator regulatory program works, address gaps in existing regulations to strengthen environmental protections, provide greater flexibility for hazardous waste generators to manage their hazardous waste in a cost-effective and protective manner, and make technical corrections to address inadvertent errors and remove obsolete references to programs that no longer exist.

### **UNCERTAINTIES OF ESTIMATES:**

There are no uncertainties of estimates regarding costs to the state or its political subdivisions.



## EFFECT ON THE ENVIRONMENT AND PUBLIC HEALTH:

The proposed revision to R.61-79 will provide continued protection of the environment and public health, as indicated above.

## DETRIMENTAL EFFECT ON THE ENVIRONMENT AND PUBLIC HEALTH IF THE REGULATION IS NOT IMPLEMENTED:

If the regulation is not implemented, there will be a detrimental effect on the environment and public health because the South Carolina would not be implementing or realizing the benefits of the EPA's Hazardous Waste Generator Improvements Rule.

## Statement of Rationale:

R.61-79 contains requirements for hazardous waste management, including identification of waste, standards for generators, transporters, and owners/operators of treatment, storage, and disposal ("TSD") facilities, procedures for permits for TSD facilities, investigation and cleanup of hazardous waste; and closure and post-closure requirements. As an authorized state program, the regulation must be equivalent to and consistent with the U.S. EPA's RCRA regulations, 42 U.S.C. Sections 6901 et seq. The EPA periodically promulgates regulations that are either mandatory for authorized state programs to adopt or maintain program equivalency or are optional for states because the changes are less stringent than the current federal regulations. While the majority of the EPA's Hazardous Waste Generator Improvements Rule is equivalent to current state regulations and optional for state adoption, several provisions are more stringent and must be adopted by the Department to maintain federal program authorization. Due to the interrelated nature of the equivalent provisions and the more stringent provisions, the Department proposes adopting the rule in a single drafting that requires General Assembly review.

## Text:

~~Indicates Matter Stricken~~

Indicates New Matter

61-79. Hazardous Waste Management Regulations.

Statutory Authority: 1976 Code Section 44-56-30

## Revise 61-79.260.3 to read:

As used in R.61-79.260 through R.61-79.266 and ~~R.61-79.268~~273:

## Revise 61-79.260.10 to add the following definitions in alphabetical order within this s

**"Acute hazardous waste"** hazardous wastes that meet the listing criteria in section R.61-79.261.11(a)(2) and therefore are either listed in R.61-79.261.31 with the assigned hazard code of (H) or are listed in ~~section R.61-79.261.33(e)~~.

**"Central accumulation area"** any on-site hazardous waste accumulation area with hazardous waste accumulating in units subject to either R.61-79.262.16 (for small quantity generators) or R.61-79.262.17 (for large quantity generators). A central accumulation area at an eligible academic entity that chooses to operate under R.61-79.262 subpart K is also subject to R.61-79.262.211 when accumulating unwanted material and/or hazardous waste.

~~“Conditionally exempt small quantity generators”~~ a generator who generates less than 100 kg hazardous waste in a month.

~~“Large quantity generator”~~ a generator who generates any of the following amounts in a calendar month:

(1) Greater than or equal to one thousand (1,000) kilograms (2,200 pounds) of non-acute hazardous waste; or

(2) Greater than one (1) kilogram (2.2 pounds) of acute hazardous waste listed in R.61-79.261.31 or 261.33(e); or

(3) Greater than one hundred (100) kilograms (220 pounds) of any residue or contaminated soil, water, or other debris resulting from the cleanup of a spill, into or on any land or water, of any acute hazardous waste listed in R.61-79.261.31 or 261.33(e).

~~“Non-acute hazardous waste”~~ all hazardous wastes that are not acute hazardous waste, as defined in this section.

~~“Small quantity generator”~~ a generator who generates less than 1000 kg of hazardous waste in a calendar month. (amended 11/90) the following amounts in a calendar month:

(1) Greater than one hundred (100) kilograms (220 pounds) but less than one thousand (1,000) kilograms (2,200 pounds) of non-acute hazardous waste; and

(2) Less than or equal to one (1) kilogram (2.2 pounds) of acute hazardous waste listed in R.61-79.261.31 or 261.33(e); and

(3) Less than or equal to one hundred (100) kilograms (220 pounds) of any residue or contaminated soil, water, or other debris resulting from the cleanup of a spill, into or on any land or water, of any acute hazardous waste listed in R.61-79.261.31 or 261.33(e).

~~“Very small quantity generator”~~ a generator who generates less than or equal to the following amounts in a calendar month:

(1) One hundred (100) kilograms (220 pounds) of non-acute hazardous waste; and

(2) One (1) kilogram (2.2 pounds) of acute hazardous waste listed in R.61-79.261.31 or 261.33(e); and

(3) One hundred (100) kilograms (220 pounds) of any residue or contaminated soil, water, or other debris resulting from the cleanup of a spill, into or on any land or water, of any acute hazardous waste listed in R.61-79.261.31 or 261.33(e).

**Revise 61-79.260.11 to read:**

**260.11 References**Incorporation by reference.

**Revise 61-79.260.11(a)(10) to read:**

(10) "Flammable and Combustible Liquids Code" (1977 or 1981 NFPA 30), available from the National Fire Protection Association, 470 Atlantic Avenue, Boston, MA 02210 1977 or 1981, IBR approved for sections 262.16(b), 264.198(b), and 265.198(b).

**Revise 61-79.261.1(a)(1) to read:**

(1) Subpart A defines the terms "solid waste" and "hazardous waste", identifies those wastes which are excluded from regulation under R.61-79.262 through 266, 268, and 270, and establishes special management requirements for hazardous waste produced by ~~conditionally exempt~~ every small quantity generators and hazardous waste which is recycled.

**Revise 61-79.261.4(a)(7) to read:**

(7) Spent sulfuric acid used to produce virgin sulfuric acid, unless it is provided it is not accumulated speculatively as defined in section 261.1(c).

**Revise 61-79.261.5 to remove and reserve it.**

**~~261.5 Special requirements for hazardous waste generated by conditionally exempt small quantity generators.~~**

~~—(a) A generator is a conditionally exempt small quantity generator in a calendar month if he generates no more than 100 kilograms of hazardous waste in that month. (amended 6/89)~~

~~—(b) Except for those wastes identified in paragraphs (e), (f), (g), and (j) a conditionally exempt small quantity generator's hazardous wastes are not subject to regulation under R.61-79.262 through R.61-79.266, R.61-79.268, R.61-79.270 and R.61-79.124, and the notification requirements of Section 3010 RCRA and the notification requirements of the South Carolina Hazardous Waste Management Act and provided the generator complies with the requirements of paragraphs (f), (g), and (j).~~

~~—(c) When making the quantity determinations of this part and R.61-79.262, the generator must include all hazardous waste that it generates, except hazardous waste that: (revised 5/96)~~

~~—(1) Is exempt from regulation under R.61-79.261.4(c) through (f), 261.6(a)(3), 261.7(a)(1), or 261.8; or (added 5/96)~~

~~—(2) Is managed immediately upon generation only in on-site elementary neutralization units, wastewater treatment units, or totally enclosed treatment facilities as defined in R.61-79.260.10; or (added 5/96)~~

~~—(3) Is recycled, without prior storage or accumulation, only in an on-site process subject to regulation under R.61-79.261.6(c)(2); or (added 5/96)~~

~~—(4) Is used oil managed under the requirements of R.61-79.261.6(a)(4) or (added 5/96)~~

~~—(5) Is spent lead acid batteries managed under the requirements of R.61-79.266 subpart G; or (added 5/96)~~

~~—(6) Is universal waste managed under R.61-79.261.9 and R.61-79.273; or~~

~~— (7) Is a hazardous waste that is an unused commercial chemical product (listed in part 261, subpart D or exhibiting one or more characteristics in part 261, subpart C) that is generated solely as a result of a laboratory clean-out conducted at an eligible academic entity pursuant to 262.213. For purposes of this provision, the term eligible academic entity shall have the meaning as defined in 262.200 of Part 262.~~

~~— (d) In determining the quantity of hazardous waste he generates, a generator need not include:~~

~~— (1) His hazardous waste when it is removed from onsite storage; or~~

~~— (2) Hazardous waste produced by onsite treatment (including reclamation) of his hazardous waste, so long as the hazardous waste that is treated was counted once; or~~

~~— (3) Spent materials that are generated, reclaimed, and subsequently reused onsite, so long as such spent materials have been counted once.~~

~~— (e) If a generator generates acute hazardous waste in a calendar month in quantities greater than set forth below, all quantities of that acute hazardous waste are subject to full regulation under R.61-79.262 through R.61-79.266, R.61-79.268, R.61-79.270 and R.61-79.124 and the notification requirements of the South Carolina Hazardous Waste Management Act Section 44-56-120 and section 3010 of RCRA: (amended 11/90; 12/92)~~

~~— (1) A total of one kilogram of acute hazardous wastes listed in sections 261.31 or 261.33(e).~~

~~— (2) A total of 100 kilograms of any residue or contaminated soil, waste, or other debris resulting from the clean-up of a spill, into or on any land or water, of any acute hazardous wastes listed in sections 261.31 or 261.33(e).~~

~~— [Comment: "Full regulation" means those regulations applicable to generators of 1,000 kg or greater of hazardous waste in a calendar month.]~~

~~— (f) In order for acute hazardous wastes generated by a generator of acute hazardous wastes in quantities equal to or less than those set forth in paragraph (e)(1) or (e)(2) of this section to be excluded from full regulation under this section, the generator must comply with the following requirements:~~

~~— (1) Sections 262.11 of R.61-79.262;~~

~~— (2) The generator may accumulate acute hazardous waste onsite. If he accumulates at any time acute hazardous wastes in quantities greater than those set forth in paragraph (e) (1) or (2) of this section, all of those accumulated wastes are subject to regulation under R.61-79.262 through R.61-79.266, R.61-79.268, R.61-79.270 and R.61-79.124 and the applicable notification requirements of Section 3010 RCRA and the applicable notification requirements of the South Carolina Hazardous Waste Management Act 44-56-120. The time period of R.61-79.262.34(a) for accumulation of wastes onsite, begins when the accumulated wastes exceed the applicable exclusion limit; (amended 11/90)~~

~~— (3) A conditionally exempt small quantity generator may either treat or dispose of his acute hazardous waste in an onsite facility, or ensure delivery to an offsite storage, treatment or disposal facility, either of which, if located in the U.S., is:~~

~~— (i) Permitted under R.61-79.270;~~

~~— (ii) In interim status under R.61-79.270 and R.61-79.265.~~

~~—— (iii) Authorized to manage hazardous waste by a State with a hazardous waste management program approved under 40 CFR 271;~~

~~—— (iv) Permitted, licensed, or registered by the Department to manage municipal solid waste and, if managed in a municipal solid waste landfill is subject to R.61-107.258; (revised 12/92; 5/96)~~

~~—— (v) Permitted, licensed, or registered by a State to manage non-municipal non-hazardous waste and, if managed in a non-municipal non-hazardous waste disposal unit after January 1, 1998, is subject to the requirements in R.61-107.257.5 through 257.30; or~~

~~—— (vi) A facility which:~~

~~—— (A) Beneficially uses or reuses, or legitimately recycles or reclaims its waste; or~~

~~—— (B) Treats its waste prior to beneficial use or reuse, or legitimate recycling or reclamation; or (revised 5/96)~~

~~—— (vii) For universal waste managed under part 273, a universal waste handler or destination facility subject to the requirements of R.61-79.273. (added 5/96)~~

~~— (g) In order for hazardous waste generated by a conditionally exempt small quantity generator in quantities of 100 kilograms or less of hazardous waste during a calendar month to be excluded from full-regulation under this section, the generator must comply with the following requirements:~~

~~—— (1) Section 262.11 of R.61-79.262;~~

~~—— (2) The conditionally exempt small quantity generator may accumulate hazardous waste onsite. If he accumulates at any time 1,000 kilograms or greater of his hazardous wastes, all of those accumulated wastes are subject to regulation under the special provisions of part 262 applicable to generators of greater than 100 kg and less than 1000 kg of hazardous waste in a calendar month as well as the requirements of 263 through 266, 268, and 270 and 124, and the applicable notification requirements of section 3010 of RCRA. The time period of 262.34(d) for accumulation of wastes on site begins for a conditionally exempt small quantity generator when the accumulated wastes equal or exceed 1000 kilograms.~~

~~—— (3) A conditionally exempt small quantity generator may either treat or dispose of his hazardous waste in an on-site facility or ensure delivery to an off-site treatment, storage or disposal facility, either of which, if located in the U.S., is:~~

~~—— (i) Permitted under R.61-79.270;~~

~~—— (ii) In interim status under R.61-79.270 and R.61-79.265;~~

~~—— (iii) Authorized to manage hazardous waste by a State with a hazardous waste management program approved under 40 CFR 271 (revised 12/92);~~

~~—— (iv) Permitted, licensed, or registered by the Department to manage municipal solid waste and, if managed in a municipal solid waste landfill is subject to R.61-107.258; (revised 6/89; 2/92; 5/96)~~

~~—— (v) Permitted, licensed, or registered by the Department to manage non-municipal non-hazardous waste and, if managed in a non-municipal non-hazardous waste disposal unit after January 1, 1998, is subject to the requirements in R.61-107.257.5 through 257.30; or~~

~~\_\_\_\_\_ (vi) A facility which:~~

~~\_\_\_\_\_ (A) Beneficially uses or reuses, or legitimately recycles or reclaims its waste; or~~

~~\_\_\_\_\_ (B) Treats its waste prior to beneficial use or reuse, or legitimate recycling or reclamation; or  
(revised 5/96)~~

~~\_\_\_\_\_ (vii) For universal waste managed under part 273, a universal waste handler or destination facility  
subject to the requirements of R.61-79.273. (added 5/96)~~

~~— (h) Hazardous waste subject to the reduced requirements of this section may be mixed with nonhazardous  
waste and remain subject to these reduced requirements even though the resultant mixture exceeds the  
quantity limitations identified in this section unless the mixture meets any of the characteristics of hazardous  
waste identified in Subpart C.~~

~~— (i) If any person mixes a solid waste with a hazardous waste that exceeds a quantity exclusion level of  
this section, the mixture is subject to full regulation.~~

~~— (j) If a conditionally exempt small quantity generator's wastes are mixed with used oil, the mixture is  
subject to R.61-79.107.279. Any material produced from such a mixture by processing, blending, or other  
treatment is also so regulated. (6/89)~~

~~— (k) [Reserved moved to 262.42(b)][Reserved]~~

**Add 61-79.261.6(c)(2)(iv) to read:**

~~\_\_\_\_\_ (iv) Section 265.75 of this chapter (quarterly report).~~

**Revise 61-79.261.33(e) to read:**

(e) The commercial chemical products, manufacturing chemical intermediates or off-specification commercial chemical products or manufacturing chemical intermediates referred to in paragraphs (a) through (d) of this section, are identified as acute hazardous wastes (H) and are subject to the small quantity exclusion defined in section 261.5(e).

**Revise 61-79.261.33(f) to read:**

(f) The commercial chemical products, manufacturing chemical intermediates, or off-specification commercial chemical products referred to in paragraphs (a) through (d) of this section, are identified as toxic wastes (T), unless otherwise designated and are subject to the small quantity generator exclusion defined in Section 261.5(a) and (g).

**Revise 61-79.262 to add section 262.1 to read:**

**262.1 Terms used in this part.**

As used in this part:

**“Condition for exemption”** any requirement in sections 262.14, 262.15, 262.16, 262.17, 262.70, or subpart K or subpart L of this part that states an event, action, or standard that must occur or be met in

order to obtain an exemption from any applicable requirement in R.61-79.124, 264 through 268, and 270 of this chapter, or from any requirement for notification under the SC Hazardous Waste Management Act section 44-56-120 and section 3010 of RCRA.

**“Independent requirement”** a requirement of R.61-79.262 that states an event, action, or standard that must occur or be met; and that applies without relation to, or irrespective of, the purpose of obtaining a conditional exemption from storage facility permit, interim status, and operating requirements under sections 262.14, 262.15, 262.16, 262.17, or subpart K or subpart L.

**f**

**Revise 61-79.262.10(a) to add item 262.10(a)(1) to read:**

(a) These regulations establish standards for generators of hazardous waste as defined by R.61-79.260.10.

(1) A person who generates a hazardous waste as defined by R.61-79.261 is subject to all the applicable independent requirements in the subparts and sections listed below:

(i) Independent requirements of a very small quantity generator.

(A) Section 262.11(a) through (d) Hazardous waste determination and recordkeeping;

(B) Section 262.12 Notification requirements upon generators; and

(C) Section 262.13 Generator category determination.

(ii) Independent requirements of a small quantity generator.

(A) Section 262.11 Hazardous waste determination and recordkeeping;

(B) Section 262.12 Notification requirements upon generators;

(C) Section 262.13 Generator category determination;

(D) Section 262.18 EPA identification numbers and renotification for small quantity generators and large quantity generators;

(E) R.61-79.262 subpart B—Manifest requirements applicable to small and large quantity generators;

(F) R.61-79.262 subpart C—Pre-transport requirements applicable to small and large quantity generators;

(G) Section 262.40 Recordkeeping;

(H) Section 262.44 Recordkeeping for small quantity generators; and

(I) R.61-79.262 subpart H—Transboundary movements of hazardous waste for recovery or disposal.

(iii) Independent requirements of a large quantity generator.

(A) Section 262.11 Hazardous waste determination and recordkeeping;

(B) Section 262.12 Notification requirements upon generators;

(C) Section 262.13 Generator category determination;

(D) Section 262.18 EPA identification numbers and renotification for small quantity generators and large quantity generators;

(E) R.61-79.262 subpart B—Manifest requirements applicable to small and large quantity generators;

(F) R.61-79.262 subpart C—Pre-transport requirements applicable to small and large quantity generators;

(G) R.61-79.262 subpart D—Recordkeeping and reporting applicable to small and large quantity generators, except section 262.44; and

(H) R.61-79.262 subpart H—Transboundary movements of hazardous waste for recovery or disposal.

(2) A generator that accumulates hazardous waste on site is a person that stores hazardous waste; such generator is subject to the applicable requirements of R.61-79.124, 264 through 266, 270, the SC Hazardous Waste Management Act Section 44-56-120, and section 3010 of RCRA, unless it is one of the following:

(i) A very small quantity generator that meets the conditions for exemption in section 262.14;

(ii) A small quantity generator that meets the conditions for exemption in sections 262.15 and 262.16; or

(iii) A large quantity generator that meets the conditions for exemption in sections 262.15 and 262.17.

(3) A generator shall not transport, offer its hazardous waste for transport, or otherwise cause its hazardous waste to be sent to a facility that is not a designated facility, as defined in section 260.10 or not otherwise authorized to receive the generator's hazardous waste.

**Revise 61-79.262.10(b) to read:**

~~(b) R.61-79.261.5(c) and (d) must be used to determine the applicability of provisions of this part that are dependent on calculations of the quantity of hazardous waste generated per month. Determining generator category. A generator must use section 262.13 to determine which provisions of this part are applicable to the generator based on the quantity of hazardous waste generated per calendar month. (revised 5/96)~~

**Revise 61-79.262.10(c) to remove and reserve it:**

~~(c) A generator who treats, stores, or disposes of hazardous waste onsite must only comply with the following sections of this part with respect to that waste: Section 262.11 for determining whether or not he has a hazardous waste, 262.12 for obtaining an EPA identification number, 262.34 for accumulation of hazardous waste, 262.40 (c) and (d) for recordkeeping, 262.43 for additional reporting, and if applicable, 262.70 for farmers. (amended 11/90, 12/92; 5/96)[Reserved]~~



**Revise 61.79.262.10(g) to add items 262.10(g)(1) to 262.10(g)(2) to read:**

~~(g) A person who generates a hazardous waste as defined by R.61-79.261 is subject to the compliance requirements and penalties prescribed in the South Carolina Hazardous Waste Management Act, section 44-56-140 of the Code of Laws of 1976 as amended, and section 3008 of the Act if he does not comply with the requirements of this part.~~

(1) A generator's violation of an independent requirement is subject to penalty and injunctive relief under the SC Hazardous Waste Management Act 44-56-120 and section 3008 of RCRA

(2) A generator's noncompliance with a condition for exemption in this part is not subject to penalty or injunctive relief under the SC Hazardous Waste Management Act 44-56-120 and section 3008 of RCRA as a violation of a R.61-79.262 condition for exemption. Noncompliance by any generator with an applicable condition for exemption from storage permit and operations requirements means that the facility is a storage facility operating without an exemption from the permit, interim status, and operations requirements in R.61-79.124, 264 through 266, and 270 of this chapter, and the notification requirements of section 3010 of RCRA. Without an exemption, any violations of such storage requirements are subject to penalty and injunctive relief under the SC Hazardous Waste Management Act Section 44-56-120 and section 3008 of RCRA.

**Revise 61-79.262.10(i) Notes 1 and 2 to read:**

~~**Note 1** The provisions of 262.34 are applicable to the onsite accumulation of hazardous waste by generators. Therefore, the provisions of 262.34 only apply to owners or operators who are shipping hazardous waste which they generated at that facility.~~

**Note 2** A generator who treats, stores, or disposes of hazardous waste onsite must comply with the applicable standards and permit requirements set forth in parts 264, 265, 266, 268, and 270.

**Revise 61-79.262.10(l) to read:**

(l) The laboratories owned by an eligible academic entity that chooses to be subject to the requirements of R.61-79.262 Subpartsubpart K of this part are not subject to (for purposes of this paragraph, the terms "laboratory" and "eligible academic entity" shall have the meaning as defined in section 262.200 of Subpart K of this part):

(1) the independent requirements of section 262.11 or 262.34(e), the regulations in section 262.15 for large quantity generators and small quantity generators, except as provided in Subpartsubpart K, and

(2) the conditions of 261.5(b), for conditionally exempt small quantity generatorssection 262.14, for very small quantity generators, except as provided in Subpartsubpart K.

**Revise 61-79.262.11(a) to 262.11(c) to read:**

**262.11 Hazardous waste determination and recordkeeping.**

A person who generates a solid waste, as defined in R.61-79.261.2 must accurately determine ifmake an accurate determination as to whether that waste is a hazardous waste using the following methodin order to ensure wastes are properly managed according to applicable RCRA regulations. A hazardous waste determination is made using the following steps:

~~(a) He should first determine if the waste is excluded from regulation under R.61-79.261.4~~The hazardous waste determination for each solid waste must be made at the point of waste generation, before any dilution, mixing, or other alteration of the waste occurs, and at any time in the course of its management that it has, or may have, changed its properties as a result of exposure to the environment or other factors that may change the properties of the waste such that the RCRA classification of the waste may change.

~~(b) He must then determine if the waste is listed as a hazardous waste in subpart D of R.61-79.261A—~~person must determine whether the solid waste is excluded from regulation under R.61-79.261.4.

~~(c) For purposes of compliance with 268, or if the waste is not listed in subpart D of R.61-79.261, the—~~generator must then determine whether the waste is identified in subpart C of R.61-79.261 by either:If the waste is not excluded under R.61-79.261.4, the person must then use knowledge of the waste to determine whether the waste meets any of the listing descriptions under subpart D of R.61-79.261. Acceptable knowledge that may be used in making an accurate determination as to whether the waste is listed may include waste origin, composition, the process producing the waste, feedstock, and other reliable and relevant information. If the waste is listed, the person may file a delisting petition under R.61-79.260.20 and 260.22 to demonstrate to the Department that the waste from this particular site or operation is not a hazardous waste.

~~— (1) Testing the waste according to the methods set forth in Subpart C of R.61-79.261, or according to an equivalent method approved by the Department under R.61-79.260.21; or~~

~~— (2) Applying knowledge of the hazard characteristic of the waste in light of the materials or the processes used.~~

**Revise 61-79.262.11(d) and add items 262.11(d)(1) to (d)(2) to read:**

~~(d) If the waste is determined to be hazardous, the generator must refer to parts 261, 264, 265, 266, 268 and 273 for possible exclusions or restrictions pertaining to management of the specific waste.~~The person then must also determine whether the waste exhibits one or more hazardous characteristics as identified in subpart C of R.61-79.261 by following the procedures in paragraph (d)(1) or (2) of this section, or a combination of both.~~(amended 11/90; 5/96)~~

(1) The person must apply knowledge of the hazard characteristic of the waste in light of the materials or the processes used to generate the waste. Acceptable knowledge may include process knowledge (e.g., information about chemical feedstocks and other inputs to the production process); knowledge of products, by-products, and intermediates produced by the manufacturing process; chemical or physical characterization of wastes; information on the chemical and physical properties of the chemicals used or produced by the process or otherwise contained in the waste; testing that illustrates the properties of the waste; or other reliable and relevant information about the properties of the waste or its constituents. A test other than a test method set forth in subpart C of R.61-79.261, or an equivalent test method approved by the Department under R.61-79.260.21, may be used as part of a person's knowledge to determine whether a solid waste exhibits a characteristic of hazardous waste. However, such tests do not, by themselves, provide definitive results. Persons testing their waste must obtain a representative sample of the waste for the testing, as defined at R.61-79.260.10.

(2) When available knowledge is inadequate to make an accurate determination, the person must test the waste according to the applicable methods set forth in subpart C of R.61-79.261 or according to an equivalent method approved by the Department under R.61-79.260.21 and in accordance with the following:

(i) Persons testing their waste must obtain a representative sample of the waste for the testing, as defined at R.61-79.260.10.

(ii) Where a test method is specified in subpart C of R.61-79.261, the results of the regulatory test, when properly performed, are definitive for determining the regulatory status of the waste.

**Revise 61-79.262.11(e) to read:**

(e) Finally, he must make a determination if the waste is listed in Appendix XI of R.61-79.261. If the waste is determined to be hazardous, the generator must refer to R.61-79.261, 264, 265, 266, 268, and 273 for other possible exclusions or restrictions pertaining to management of the specific waste.

**Revise 61-79.262.11 to add subsections 262.11(f) to 262.11(g) to read:**

(f) Recordkeeping for small and large quantity generators. A small or large quantity generator must maintain records supporting its hazardous waste determinations, including records that identify whether a solid waste is a hazardous waste, as defined by R.61-79.261.3 Records must be maintained for at least three (3) years from the date that the waste was last sent to on-site or off-site treatment, storage, or disposal. These records must comprise the generator's knowledge of the waste and support the generator's determination, as described at paragraphs (c) and (d) of this section. The records must include, but are not limited to, the following types of information: the results of any tests, sampling, waste analyses, or other determinations made in accordance with this section; records documenting the tests, sampling, and analytical methods used to demonstrate the validity and relevance of such tests; records consulted in order to determine the process by which the waste was generated, the composition of the waste, and the properties of the waste; and records which explain the knowledge basis for the generator's determination, as described at R.61-79 paragraph (d)(1) of this section. The periods of record retention referred to in this section are extended automatically during the course of any unresolved enforcement action regarding the regulated activity or as requested by the Department.

(g) Identifying hazardous waste numbers for small and large quantity generators. If the waste is determined to be hazardous, small quantity generators and large quantity generators must identify all applicable EPA hazardous waste numbers (EPA hazardous waste codes) in subparts C and D of R.61-79.261. Prior to shipping the waste off site, the generator also must mark its containers with all applicable EPA hazardous waste numbers (EPA hazardous waste codes) according to section 262.32.

**Revise 61-79.262.12 to read:**

**262.12 Identification Numbers.**

~~—(a) A generator must not treat, store, dispose of, transport, or offer for transportation, hazardous waste—without having received an EPA identification number from the Department.~~

~~—(b) A generator who has not received an EPA identification number may obtain one by submitting the Notification Form required under Section 262.13. Upon receipt of the completed form the Department will assign an EPA identification number to the generator.~~

~~—(c) A generator must not offer his hazardous waste to transporters or to treatment, storage, or disposal facilities that have not received an EPA identification number or a Department permit. A facility which has interim status is deemed permitted until issuance of a permit is made by the Department.~~

~~—(d) A recognized trader must not arrange for import or export of hazardous waste without having received an EPA identification number from the Administrator.~~ **Notification Requirements upon Generators.**

(a) Every generator within the state who produces a hazardous waste and has not previously done so shall file with the Department a Notification Form for that waste within thirty (30) days of the effective date of this regulation.

(b) Every generator within the state who produces a new hazardous waste shall file with the Department a revised or new Notification Form for that waste within thirty (30) days after such waste is first produced.

(c) Every generator within the state who produces a hazardous waste which is classified or listed for the first time by a revision of R.61-79.261 shall file with the Department a revised or new Notification Form for that waste within ninety (90) days after the effective date of such revision.

(d) The notification shall be on a form designated by the Department, shall be completed as required by the instructions supplied with such forms. The information to be furnished on the form shall include but not be limited to the location and general description of such activity, the identified or listed hazardous wastes handled by such person and, if applicable, a description of the production of energy recovery activity carried out at the facility and such other information as the Department deems necessary. A generator shall file a revised or new Notification form whenever the information previously provided becomes outdated or inaccurate.

(e) Persons engaged in the following activities are required to make a separate notification:

(1) Producers of fuels from:

(i) Any hazardous waste identified or listed in R.61-79.261;

(ii) Used oil; and

(iii) Used oil and any other material.

(2) Burners (other than a single two-family residence) for purposed of energy recovery any fuel produced as identified in paragraph one (1).

(3) Distributors or marketers of any fuel as identified in paragraph one (1).

(f) Every generator within the State who no longer produces any hazardous waste shall file with the Department one subsequent Notification form.

**Revise 61-79.262.13 to read:**

**262.13 Notification Requirements upon GeneratorsGenerator category determination.**

A generator must determine its generator category. A generator's category is based on the amount of hazardous waste generated each month and may change from month to month. This section sets forth procedures to determine whether a generator is a very small quantity generator, a small quantity generator, or a large quantity generator for a particular month, as defined in R.61-79.260.10.

~~(a) Every generator within the State who produces a hazardous waste and has not previously done so shall file with the Department a Notification Form for that waste within thirty (30) days of the effective~~

~~date of this regulation. Generators of either acute hazardous waste or non-acute hazardous waste. A generator who either generates acute hazardous waste or non-acute hazardous waste in a calendar month shall determine its generator category for that month by doing the following:~~

- ~~(1) Counting the total amount of hazardous waste generated in the calendar month;~~
- ~~(2) Subtracting from the total of any amounts of waste exempt from counting as described in paragraphs (c) and (d) of this section; and~~
- ~~(3) Determining the resulting generator category for the hazardous waste generated using Table 1 of this section.~~

~~(b) Every generator within the State who produces a new hazardous waste shall file with the Department a revised or new Notification Form for that waste within thirty (30) days after such waste is first produced. Generators of both acute and non-acute hazardous wastes. A generator who generates both acute hazardous waste and non-acute hazardous waste in the same calendar month shall determine its generator category for that month by doing the following:~~

- ~~(1) Counting separately the total amount of acute hazardous waste and the total amount of non-acute hazardous waste generated in the calendar month;~~
- ~~(2) Subtracting from each total any amounts of waste exempt from counting as described in paragraphs (c) and (d) of this section;~~
- ~~(3) Determining separately the resulting generator categories for the quantities of acute and non-acute hazardous waste generated using Table 1 of this section; and~~
- ~~(4) Comparing the resulting generator categories from paragraph (b)(3) of this section and applying the more stringent generator category to the accumulation and management of both non-acute hazardous waste and acute hazardous waste generated for that month.~~

<u>Table 1 to section 262.13 – Generator Categories Based on Quantity of Waste Generated in a Calendar Month</u>			
<u>Quantity of acute hazardous waste generated in a calendar month</u>	<u>Quantity of non-acute hazardous waste generated in a calendar month</u>	<u>Quantity of residues from a cleanup of acute hazardous waste generated in a calendar month</u>	<u>Generator category</u>
<u>&gt;1 kg</u>	<u>Any amount</u>	<u>Any amount</u>	<u>Large quantity generator.</u>
<u>Any amount</u>	<u>≥ 1,000 kg</u>	<u>Any amount</u>	<u>Large quantity generator.</u>
<u>Any amount</u>	<u>Any amount</u>	<u>&gt; 100 kg</u>	<u>Large quantity generator.</u>
<u>≤ 1 kg</u>	<u>&gt; 100 kg and &lt; 1,000 kg</u>	<u>≤ 100 kg</u>	<u>Small quantity generator.</u>
<u>≤ 1 kg</u>	<u>≤ 100 kg</u>	<u>≤ 100 kg</u>	<u>Very small quantity generator.</u>

~~(c) Every generator within the State who produces a hazardous waste which is classified or listed for the first time by a revision of R.61-79.261 shall file with the Department a revised or new Notification Form for that waste within ninety (90) days after the effective date of such revision. When making the monthly quantity-based determinations required by R.61-79.262, the generator must include all hazardous waste that it generates, except hazardous waste that:~~

~~\_\_\_\_\_ (1) Is exempt from regulation under sections 261.4(c) through (f), 261.6(a)(3), 261.7(a)(1), or 261.8;~~

~~\_\_\_\_\_ (2) Is managed immediately upon generation only in on-site elementary neutralization units, wastewater treatment units, or totally enclosed treatment facilities as defined in R.61-79.260.10;~~

~~\_\_\_\_\_ (3) Is recycled, without prior storage or accumulation, only in an on-site process subject to regulation under section 261.6(c)(2);~~

~~\_\_\_\_\_ (4) Is used oil managed under the requirements of 261.6(a)(4);~~

~~\_\_\_\_\_ (5) Is spent lead-acid batteries managed under the requirements of R.61-79.266 subpart G;~~

~~\_\_\_\_\_ (6) Is universal waste managed under R.61-79.261.9 and R.61-79.273;~~

~~\_\_\_\_\_ (7) Is a hazardous waste that is an unused commercial chemical product (listed in R.61-79.261 subpart D or exhibiting one or more characteristics in R.61-79.261 subpart C) that is generated solely as a result of a laboratory clean-out conducted at an eligible academic entity pursuant to R.61-79.262.213. For purposes of this provision, the term eligible academic entity shall have the meaning as defined in R.61-79.262.200; or~~

~~\_\_\_\_\_ (8) Is managed as part of an episodic event in compliance with the conditions of R.61-79.262 subpart L.~~

~~(d) The notification shall be on a form designated by the Department, shall be completed as required by the instructions supplied with such forms. The information to be furnished on the form shall include but not be limited to the location and general description of such activity, the identified or listed hazardous wastes handled by such person and, if applicable, a description of the production of energy recovery activity carried out at the facility and such other information as the Department deems necessary. A generator shall file a revised or new Notification form whenever the information previously provided becomes outdated or inaccurate. In determining the quantity of hazardous waste generated in a calendar month, a generator need not include:~~

~~\_\_\_\_\_ (1) Hazardous waste when it is removed from on-site accumulation, so long as the hazardous waste was previously counted once;~~

~~\_\_\_\_\_ (2) Hazardous waste generated by on-site treatment (including reclamation) of the generator's hazardous waste, so long as the hazardous waste that is treated was previously counted once; and~~

~~\_\_\_\_\_ (3) Hazardous waste spent materials that are generated, reclaimed, and subsequently reused on site, so long as such spent materials have been previously counted once.~~

~~(e) Persons engaged in the following activities are required to make a separate notification: Based on the generator category as determined under this section, the generator must meet the applicable independent requirements listed in R.61-79.262.10. A generator's category also determines which of the provisions of~~

R.61-79.262.14, 262.15, 262.16 or 262.17 must be met to obtain an exemption from the storage facility permit, interim status, and operating requirements when accumulating hazardous waste.

~~— (1) Producers of fuels from;~~

~~— (i) Any hazardous waste identified or listed in R.61-79.261;~~

~~— (ii) Used oil; and~~

~~— (iii) Used oil and any other material.~~

~~— (2) Burners (other than a single or two family residence) for purposes of energy recovery any fuel produced as identified in paragraph 1.~~

~~— (3) Distributors or marketers of any fuel as identified in paragraph 1.~~

~~(f) Every generator within the State who no longer produces any hazardous waste shall file with the Department one subsequent Notification form. Mixing hazardous wastes with solid wastes.~~

(1) Very small quantity generator wastes.

(i) Hazardous wastes generated by a very small quantity generator may be mixed with solid wastes. Very small quantity generators may mix a portion or all of its hazardous waste with solid waste and remain subject to section 262.14 even though the resultant mixture exceeds the quantity limits identified in the definition of “very small quantity generator” at section 260.10 of this chapter, unless the mixture exhibits one or more of the characteristics of hazardous waste identified in R.61-79.261 subpart C.

(ii) If the resulting mixture exhibits a characteristic of hazardous waste, this resultant mixture is a newly-generated hazardous waste. The very small quantity generator must count both the resultant mixture amount plus the other hazardous waste generated in the calendar month to determine whether the total quantity exceeds the very small quantity generator calendar month quantity limits identified in the definition of generator categories found in R.61-79.260.10. If so, to remain exempt from the permitting, interim status, and operating standards, the very small quantity generator must meet the conditions for exemption applicable to either a small quantity generator or a large quantity generator. The very small quantity generator must also comply with the applicable independent requirements for either a small quantity generator or a large quantity generator.

(2) Small quantity generator and large quantity generator wastes.

(i) Hazardous wastes generated by a small quantity generator or large quantity generator may be mixed with solid waste. These mixtures are subject to the following: the mixture rule in sections 261.3(a)(2)(iv), (b)(2) and (3), and (g)(2)(i); the prohibition of dilution rule at section 268.3(a); the land disposal restriction requirements of R.61-79.268.40 if a characteristic hazardous waste is mixed with a solid waste so that it no longer exhibits the hazardous characteristic; and the hazardous waste determination requirement at R.61-79.262.11.

(ii) If the resulting mixture is found to be a hazardous waste, this resultant mixture is a newly-generated hazardous waste. A small quantity generator must count both the resultant mixture amount plus the other hazardous waste generated in the calendar month to determine whether the total quantity exceeds the small quantity generator calendar monthly quantity limits identified in the definition of generator categories found in R.61-79.260.10. If so, to remain exempt from the permitting, interim status, and

operating standards, the small quantity generator must meet the conditions for exemption applicable to a large quantity generator. The small quantity generator must also comply with the applicable independent requirements for a large quantity generator.

**Revise 61-79.262 to add section 262.14 to read:**

**262.14 Conditions for exemption for a very small quantity generator.**

(a) Provided that the very small quantity generator meets all the conditions for exemption listed in this section, hazardous waste generated by the very small quantity generator is not subject to the requirements of R.61-79.124, 262 (except sections 262.10-262.14) through 268, and 270, and the notification requirements of the SC Hazardous Waste Management Act Section 44-56-120 and section 3010 of RCRA and the very small quantity generator may accumulate hazardous waste on site without complying with such requirements. The conditions for exemption are as follows:

(1) In a calendar month the very small quantity generator generates less than or equal to the amounts specified in the definition of “very small quantity generator” in R.61-79.260.10;

(2) The very small quantity generator complies with ~~section~~ R.61-79.262.11(a) through (d);

(3) If the very small quantity generator accumulates at any time greater than one (1) kilogram (2.2 pounds) of acute hazardous waste or one hundred (100) kilograms (220 pounds) of any residue or contaminated soil, water, or other debris resulting from the cleanup of a spill, into or on any land or water, of any acute hazardous waste listed in R.61-79.261.31 or 261.33(e), all quantities of that acute hazardous waste are subject to the following additional conditions for exemption:

(i) Such waste is held on site for no more than ninety (90) days beginning on the date when the accumulated wastes exceed the amounts provided above; and

(ii) The conditions for exemption in R.61-79.262.17(a) through (g).

(4) If the very small quantity generator accumulates at any time one thousand (1,000) kilograms (2,200 pounds) or greater of non-acute hazardous waste, all quantities of that hazardous waste are subject to the following additional conditions for exemption:

(i) Such waste is held on site for no more than one hundred eighty (180) days, or two hundred seventy (270) days, if applicable, beginning on the date when the accumulated waste exceeds the amounts provided above;

(ii) The quantity of waste accumulated on site never exceeds six thousand (6,000) kilograms (13,200 pounds); and

(iii) The conditions for exemption in R.61-79.262.16(b)(2) through (f).

(5) A very small quantity generator that accumulates hazardous waste in amounts less than or equal to the limits in paragraphs (a)(3) and (4) of this section must either treat or dispose of its hazardous waste in an on-site facility or ensure delivery to an off-site treatment, storage, or disposal facility, either of which, if located in the U.S., is:

(i) Permitted under R.61-79.270;



(ii) In interim status under R.61-79.265 and 270;

(iii) [Reserved]

(iv) Permitted, licensed, or registered by a state to manage municipal solid waste and, if managed in a municipal solid waste landfill is subject to R.61-107.19 and 40 CFR Part 258;

(v) Permitted, licensed, or registered by a state to manage non-municipal non-hazardous waste and, if managed in a non-municipal non-hazardous waste disposal unit, is subject to the requirements in R.61-107.19 and 40 CFR 257.5 through 257.30;

(vi) A facility which:

(A) Beneficially uses or reuses, or legitimately recycles or reclaims its waste; or

(B) Treats its waste prior to beneficial use or reuse, or legitimate recycling or reclamation;

(vii) For universal waste managed under R.61-79.273, a universal waste handler or destination facility subject to the requirements of R.61-79.273;

(viii) A large quantity generator under the control of the same person as the very small quantity generator, provided the following conditions are met:

(A) The very small quantity generator and the large quantity generator are under the control of the same person as defined in R.61-79.260.10. "Control," for the purposes of this section, means the power to direct the policies of the generator, whether by the ownership of stock, voting rights, or otherwise, except that contractors who operate generator facilities on behalf of a different person as defined in R.61-79.260.10 shall not be deemed to "control" such generators.

(B) The very small quantity generator marks its container(s) of hazardous waste with:

(1) The words "Hazardous Waste" and

(2) An indication of the hazards of the contents (examples include, but are not limited to, the applicable hazardous waste characteristic(s) (i.e., ignitable, corrosive, reactive, toxic); hazard communication consistent with the Department of Transportation requirements at 49 CFR part 172 subpart E (labeling) or subpart F (placarding); a hazard statement or pictogram consistent with the Occupational Safety and Health Administration Hazard Communication Standard at 29 CFR 1910.1200; or a chemical hazard label consistent with the National Fire Protection Association code 704).

(b) The placement of bulk or non-containerized liquid hazardous waste or hazardous waste containing free liquids (whether or not sorbents have been added) in any landfills is prohibited.

(c) A very small quantity generator experiencing an episodic event may generate and accumulate hazardous waste in accordance with R.61-79.262 subpart L in lieu of R.61-79.262.15, 262.16, and 262.17.

**Revise 61-79.262 to add section 262.15 to read:**

**262.15 Satellite accumulation area regulations for small and large quantity generators**

(a) A generator may accumulate as much as fifty-five (55) gallons of non-acute hazardous waste and/or either one quart of liquid acute hazardous waste listed in R.61-79.261.31 or section 261.33(e) or one (1) kilogram (2.2 pounds) of solid acute hazardous waste listed in R.61-79.261.31 or section 261.33(e) in containers at or near any point of generation where wastes initially accumulate which is under the control of the operator of the process generating the waste, without a permit or interim status and without complying with the requirements of R.61-79.124, 264 through 267, and 270, provided that all of the conditions for exemption in this section are met. A generator may comply with the conditions for exemption in this section instead of complying with the conditions for exemption in section 262.16(b) or section 262.17(a), except as required in section 262.15(a)(7) and (8). The conditions for exemption for satellite accumulation are:

(1) If a container holding hazardous waste is not in good condition, or if it begins to leak, the generator must immediately transfer the hazardous waste from this container to a container that is in good condition and does not leak, or immediately transfer and manage the waste in a central accumulation area operated in compliance with R.61-79.262.16(b) or ~~section~~ 262.17(a).

(2) The generator must use a container made of or lined with materials that will not react with, and are otherwise compatible with, the hazardous waste to be accumulated, so that the ability of the container to contain the waste is not impaired.

(3) Special standards for incompatible wastes.

(i) Incompatible wastes, or incompatible wastes and materials, (see appendix V of R.61-79.265 for examples) must not be placed in the same container, unless R.61-79.265.17(b) is complied with.

(ii) Hazardous waste must not be placed in an unwashed container that previously held an incompatible waste or material (see appendix V of R.61-79.265 for examples), unless R.61-79.65.17(b) is complied with.

(iii) A container holding a hazardous waste that is incompatible with any waste or other materials accumulated nearby in other containers must be separated from the other materials or protected from them by any practical means.

(4) A container holding hazardous waste must be closed at all times during accumulation, except:

(i) When adding, removing, or consolidating waste; or

(ii) When temporary venting of a container is necessary

(A) For the proper operation of equipment, or

(B) To prevent dangerous situations, such as build-up of extreme pressure.

(5) A generator must mark or label its container with the following:

(i) The words "Hazardous Waste" and

(ii) An indication of the hazards of the contents (examples include, but are not limited to, the applicable hazardous waste characteristic(s) (i.e., ignitable, corrosive, reactive, toxic); hazard communication consistent with the Department of Transportation requirements at 49 CFR part 172 subpart E (labeling) or subpart F (placarding); a hazard statement or pictogram consistent with the Occupational

Safety and Health Administration Hazard Communication Standard at 29 CFR 1910.1200; or a chemical hazard label consistent with the National Fire Protection Association code 704).

(6) A generator who accumulates either acute hazardous waste listed in R.61-79.261.31 or section 261.33(e) or non-acute hazardous waste in excess of the amounts listed in paragraph (a) of this section at or near any point of generation must do the following:

(i) Comply within three (3) consecutive calendar days with the applicable central accumulation area regulations in 262.16(b) or ~~section~~R.61-79.262.17(a), or

(ii) Remove the excess from the satellite accumulation area within three (3) consecutive calendar days to either:

(A) A central accumulation area operated in accordance with the applicable regulations in section 262.16(b) or section 262.17(a);

(B) An on-site interim status or permitted treatment, storage, or disposal facility, or

(C) An off-site designated facility; and

(iii) During the three (3)-consecutive-calendar-day period the generator must continue to comply with paragraphs (a)(1) through (5) of this section. The generator must mark or label the container(s) holding the excess accumulation of hazardous waste with the date the excess amount began accumulating.

(7) All satellite accumulation areas operated by a small quantity generator must meet the preparedness and prevention regulations of 262.16(b)(8) and emergency procedures at section 262.16(b)(9).

(8) All satellite accumulation areas operated by a large quantity generator must meet the Preparedness, Prevention and Emergency Procedures in R.61-79.262 subpart M.

(b) [Reserved].

**Revise 61-79.262 to add section 262.16 to read:**

### **262.16 Conditions for exemption for a small quantity generator that accumulates haza**

A small quantity generator may accumulate hazardous waste on site without a permit or interim status, and without complying with the requirements of R.61-79.124, 264 through 266, and 270, or the notification requirements of the SC Hazardous Waste Management Act 44-56-120 and section 3010 of the RCRA, provided that all the conditions for exemption listed in this section are met:

(a) Generation. The generator generates in a calendar month no more than the amounts specified in the definition of “small quantity generator” in R.61-79.260.10.

(b) Accumulation. The generator accumulates hazardous waste on site for no more than one hundred eighty (180) days, unless in compliance with the conditions for exemption for longer accumulation in paragraphs (d) and (e) of this section. The following accumulation conditions also apply:

(1) Accumulation limit. The quantity of hazardous waste accumulated on site never exceeds six thousand (6,000) kilograms (13,200 pounds);

(2) Accumulation of hazardous waste in containers—

(i) Condition of containers. If a container holding hazardous waste is not in good condition, or if it begins to leak, the small quantity generator must immediately transfer the hazardous waste from this container to a container that is in good condition, or immediately manage the waste in some other way that complies with the conditions for exemption of this section.

(ii) Compatibility of waste with container. The small quantity generator must use a container made of or lined with materials that will not react with, and are otherwise compatible with, the hazardous waste to be accumulated, so that the ability of the container to contain the waste is not impaired.

(iii) Management of containers.

(A) A container holding hazardous waste must always be closed during accumulation, except when it is necessary to add or remove waste.

(B) A container holding hazardous waste must not be opened, handled, or accumulated in a manner that may rupture the container or cause it to leak.

(C) A generator may not stack containers of hazardous waste more than two containers high without first obtaining written approval from the Department.

(iv) Inspections. At least weekly, the small quantity generator must inspect central accumulation areas. The small quantity generator must look for leaking containers and for deterioration of containers caused by corrosion or other factors. See paragraph (b)(2)(i) of this section for remedial action required if deterioration or leaks are detected.

(v) Special conditions for accumulation of incompatible wastes.

(A) Incompatible wastes, or incompatible wastes and materials, (see appendix V of R.61-79.265 for examples) must not be placed in the same container, unless section 265.17(b) is complied with.

(B) Hazardous waste must not be placed in an unwashed container that previously held an incompatible waste or material (see appendix V of R.61-79.265 for examples), unless section 265.17(b) is complied with.

(C) A container accumulating hazardous waste that is incompatible with any waste or other materials accumulated or stored nearby in other containers, piles, open tanks, or surface impoundments must be separated from the other materials or protected from them by means of a dike, berm, wall, or other device.

(3) Accumulation of hazardous waste in tanks.

(i) [Reserved].

(ii) A small quantity generator of hazardous waste must comply with the following general operating conditions:

(A) Treatment or accumulation of hazardous waste in tanks must comply with section 265.17(b).

(B) Hazardous wastes or treatment reagents must not be placed in a tank if they could cause the tank or its inner liner to rupture, leak, corrode, or otherwise fail before the end of its intended life.

(C) Uncovered tanks must be operated to ensure at least sixty (60) centimeters (2 feet) of freeboard, unless the tank is equipped with a containment structure (e.g., dike or trench), a drainage control system, or a diversion structure (e.g., standby tank) with a capacity that equals or exceeds the volume of the top sixty (60) centimeters (2 feet) of the tank.

(D) Where hazardous waste is continuously fed into a tank, the tank must be equipped with a means to stop this inflow (e.g., waste feed cutoff system or by-pass system to a stand-by tank).

(iii) Except as noted in paragraph (b)(3)(iv) of this section, a small quantity generator that accumulates hazardous waste in tanks must inspect, where present:

(A) Discharge control equipment (e.g., waste feed cutoff systems, by-pass systems, and drainage systems) at least once each operating day, to ensure that it is in good working order;

(B) Data gathered from monitoring equipment (e.g., pressure and temperature gauges) at least once each operating day to ensure that the tank is being operated according to its design;

(C) The level of waste in the tank at least once each operating day to ensure compliance with paragraph (b)(3)(ii)(C) of this section;

(D) The construction materials of the tank at least weekly to detect corrosion or leaking of fixtures or seams; and

(E) The construction materials of, and the area immediately surrounding, discharge confinement structures (e.g., dikes) at least weekly to detect erosion or obvious signs of leakage (e.g., wet spots or dead vegetation). The generator must remedy any deterioration or malfunction of equipment or structures which the inspection reveals on a schedule which ensures that the problem does not lead to an environmental or human health hazard. Where a hazard is imminent or has already occurred, remedial action must be taken immediately.

(iv) A small quantity generator accumulating hazardous waste in tanks or tank systems that have full secondary containment and that either use leak detection equipment to alert personnel to leaks, or implement established workplace practices to ensure leaks are promptly identified, must inspect at least weekly, where applicable, the areas identified in paragraphs (b)(3)(iii)(A) through (E) of this section. Use of the alternate inspection schedule must be documented in the generator's operating record. This documentation must include a description of the established workplace practices at the generator.

(v) [Reserved].

(vi) A small quantity generator accumulating hazardous waste in tanks must, upon closure of the facility, remove all hazardous waste from tanks, discharge control equipment, and discharge confinement structures. At closure, as throughout the operating period, unless the small quantity generator can demonstrate, in accordance with section 261.3(c) or (d), that any solid waste removed from its tank is not a hazardous waste, then it must manage such waste in accordance with all applicable provisions of R.61-79.262, 263, 265 and 268.

(vii) A small quantity generator must comply with the following special conditions for accumulation of ignitable or reactive waste:

(A) Ignitable or reactive waste must not be placed in a tank, unless:

(1) The waste is treated, rendered, or mixed before or immediately after placement in a tank so that the resulting waste, mixture, or dissolution of material no longer meets the definition of ignitable or reactive waste under R.61-79.261.21 or R.61-79.261.23 and R.61-79.265.17(b) is complied with; or

(2) The waste is accumulated or treated in such a way that it is protected from any material or conditions that may cause the waste to ignite or react; or

(3) The tank is used solely for emergencies.

(B) A small quantity generator which treats or accumulates ignitable or reactive waste in covered tanks must comply with the buffer zone requirements for tanks contained in Tables 2-1 through 2-6 of the National Fire Protection Association's "Flammable and Combustible Liquids Code" (1977 or 1981) (incorporated by reference, see R.61-79.260.11).

(C) A small quantity generator must comply with the following special conditions for incompatible wastes:

(1) Incompatible wastes, or incompatible wastes and materials, (see appendix V of R.61-79.265 for examples) must not be placed in the same tank, unless section R.61-79.265.17(b) of this chapter is complied with.

(2) Hazardous waste must not be placed in an unwashed tank that previously held an incompatible waste or material, unless 265.17(b) of this chapter is complied with.

(4) Accumulation of hazardous waste on drip pads. If the waste is placed on drip pads, the small quantity generator must comply with the following:

(i) Subpart W of R.61-79.265 (except R.61-79. 265.445(c));

(ii) The small quantity generator must remove all wastes from the drip pad at least once every ninety (90) days. Any hazardous wastes that are removed from the drip pad at least once every ninety (90) days are then subject to the one hundred eighty (180)-day accumulation limit in paragraph (b) of this section and R.61-79.262.15 if hazardous wastes are being managed in satellite accumulation areas prior to being moved to the central accumulation area; and

(iii) The small quantity generator must maintain on site at the facility the following records readily available for inspection:

(A) A written description of procedures that are followed to ensure that all wastes are removed from the drip pad and associated collection system at least once every ninety (90) days; and

(B) Documentation of each waste removal, including the quantity of waste removed from the drip pad and the sump or collection system and the date and time of removal.

(5) Accumulation of hazardous waste in containment buildings. If the waste is placed in containment buildings, the small quantity generator must comply with of R.61-79.265 subpart DD. The generator must label its containment buildings with the words "Hazardous Waste" in a conspicuous place easily visible to employees, visitors, emergency responders, waste handlers, or other persons on site and also in a

conspicuous place provide an indication of the hazards of the contents (examples include, but are not limited to, the applicable hazardous waste characteristic(s) (i.e., ignitable, corrosive, reactive, toxic); hazard communication consistent with the Department of Transportation requirements at 49 CFR part 172 subpart E (labeling) or subpart F (placarding); a hazard statement or pictogram consistent with the Occupational Safety and Health Administration Hazard Communication Standard at 29 CFR 1910.1200; or a chemical hazard label consistent with the National Fire Protection Association code 704).The generator must also maintain:

(i) The professional engineer certification that the building complies with the design standards specified in R.61-79.265.1101. This certification must be in the generator's files prior to operation of the unit; and

(ii) The following records by use of inventory logs, monitoring equipment, or any other effective means:

(A) A written description of procedures to ensure that each waste volume remains in the unit for no more than ninety (90) days, a written description of the waste generation and management practices for the facility showing that the generator is consistent with maintaining the ninety (90) day limit, and documentation that the procedures are complied with; or

(B) Documentation that the unit is emptied at least once every ninety (90) days.

(C) Inventory logs or records with the above information must be maintained on site and readily available for inspection.

(6) Labeling and marking of containers and tanks—

(i) Containers. A small quantity generator must mark or label its containers with the following:

(A) The words “Hazardous Waste”;

(B) An indication of the hazards of the contents (examples include, but are not limited to, the applicable hazardous waste characteristic(s) (i.e., ignitable, corrosive, reactive, toxic); hazard communication consistent with the Department of Transportation requirements at 49 CFR part 172 subpart E (labeling) or subpart F (placarding); a hazard statement or pictogram consistent with the Occupational Safety and Health Administration Hazard Communication Standard at 29 CFR 1910.1200; or a chemical hazard label consistent with the National Fire Protection Association code 704); and

(C) The date upon which each period of accumulation begins clearly visible for inspection on each container.

(ii) Tanks. A small quantity generator accumulating hazardous waste in tanks must do the following:

(A) Mark or label its tanks with the words “Hazardous Waste”;

(B) Mark or label its tanks with an indication of the hazards of the contents (examples include, but are not limited to, the applicable hazardous waste characteristic(s) (i.e., ignitable, corrosive, reactive, toxic); hazard communication consistent with the Department of Transportation requirements at 49 CFR part 172 subpart E (labeling) or subpart F (placarding); a hazard statement or pictogram consistent with the Occupational Safety and Health Administration Hazard Communication Standard at 29 CFR 1910.1200; or a chemical hazard label consistent with the National Fire Protection Association code 704);

(C) Use inventory logs, monitoring equipment, or other records to demonstrate that hazardous waste has been emptied within one hundred eighty (180) days of first entering the tank if using a batch process, or in the case of a tank with a continuous flow process, demonstrate that estimated volumes of hazardous waste entering the tank daily exit the tank within one hundred eighty (180) days of first entering; and

(D) Keep inventory logs or records with the above information on site and readily available for inspection.

(7) Land disposal restrictions. A small quantity generator must comply with all the applicable requirements under R.61-79.268.

(8) Preparedness and prevention—

(i) Maintenance and operation of facility. A small quantity generator must maintain and operate its facility to minimize the possibility of a fire, explosion, or any unplanned sudden or non-sudden release of hazardous waste or hazardous waste constituents to air, soil, or surface water which could threaten human health or the environment.

(ii) Required equipment. All areas where hazardous waste is either generated or accumulated must be equipped with the items in paragraphs (b)(8)(ii)(A) through (D) of this section (unless none of the hazards posed by waste handled at the facility could require a particular kind of equipment specified below or the actual waste generation or accumulation area does not lend itself for safety reasons to have a particular kind of equipment specified below). A small quantity generator may determine the most appropriate locations to locate equipment necessary to prepare for and respond to emergencies.

(A) An internal communications or alarm system capable of providing immediate emergency instruction (voice or signal) to facility personnel;

(B) A device, such as a telephone (immediately available at the scene of operations) or a hand-held two-way radio, capable of summoning emergency assistance from local police departments, fire departments, or state or local emergency response teams;

(C) Portable fire extinguishers, fire control equipment (including special extinguishing equipment, such as that using foam, inert gas, or dry chemicals), spill control equipment, and decontamination equipment; and

(D) Water at adequate volume and pressure to supply water hose streams, or foam producing equipment, or automatic sprinklers, or water spray systems.

(iii) Testing and maintenance of equipment. All communications or alarm systems, fire protection equipment, spill control equipment, and decontamination equipment, where required, must be tested and maintained as necessary to assure its proper operation in time of emergency.

(iv) Access to communications or alarm system.

(A) Whenever hazardous waste is being poured, mixed, spread, or otherwise handled, all personnel involved in the operation must have immediate access (e.g., direct or unimpeded access) to an internal alarm or emergency communication device, either directly or through visual or voice contact with another employee, unless such a device is not required under paragraph (a)(8)(ii) of this section.



(B) In the event there is just one employee on the premises while the facility is operating, the employee must have immediate access (e.g., direct or unimpeded access) to a device, such as a telephone (immediately available at the scene of operation) or a hand-held two-way radio, capable of summoning external emergency assistance, unless such a device is not required under paragraph (a)(8)(ii) of this section.

(v) Required aisle space. The small quantity generator must maintain aisle space to allow the unobstructed movement of personnel, fire protection equipment, spill control equipment, and decontamination equipment to any area of facility operation in an emergency, unless aisle space is not needed for any of these purposes.

(vi) Arrangements with local authorities.

(A) The small quantity generator must attempt to make arrangements with the local police department, fire department, other emergency response teams, emergency response contractors, equipment suppliers and local hospitals, taking into account the types and quantities of hazardous wastes handled at the facility. Arrangements may be made with the Local Emergency Planning Committee, if it is determined to be the appropriate organization with which to make arrangements.

(1) A small quantity generator attempting to make arrangements with its local fire department must determine the potential need for the services of the local police department, other emergency response teams, emergency response contractors, equipment suppliers and local hospitals.

(2) As part of this coordination, the small quantity generator shall attempt to make arrangements, as necessary, to familiarize the above organizations with the layout of the facility, the properties of hazardous waste handled at the facility and associated hazards, places where facility personnel would normally be working, entrances to roads inside the facility, and possible evacuation routes as well as the types of injuries or illnesses that could result from fires, explosions, or releases at the facility.

(3) Where more than one police or fire department might respond to an emergency, the small quantity generator shall attempt to make arrangements designating primary emergency authority to a specific fire or police department, and arrangements with any others to provide support to the primary emergency authority.

(B) A small quantity generator shall maintain records documenting the arrangements with the local fire department as well as any other organization necessary to respond to an emergency. This documentation must include documentation in the operating record that either confirms such arrangements actively exist or, in cases where no arrangements exist, confirms that attempts to make such arrangements were made.

(C) A facility possessing 24-hour response capabilities may seek a waiver from the authority having jurisdiction (AHJ) over the fire code within the facility's state or locality as far as needing to make arrangements with the local fire department as well as any other organization necessary to respond to an emergency, provided that the waiver is documented in the operating record.

(9) Emergency procedures. The small quantity generator complies with the following conditions for those areas of the generator facility where hazardous waste is generated and accumulated:

(i) At all times there must be at least one employee either on the premises or on call (i.e., available to respond to an emergency by reaching the facility within a short period of time) with the responsibility

for coordinating all emergency response measures specified in paragraph (b)(9)(iv) of this section. This employee is the emergency coordinator.

(ii) The small quantity generator must post the following information next to telephones or in areas directly involved in the generation and accumulation of hazardous waste:

(A) The name and emergency telephone number of the emergency coordinator;

(B) Location of fire extinguishers and spill control material, and, if present, fire alarm; and

(C) The telephone number of the fire department, unless the facility has a direct alarm.

(iii) The small quantity generator must ensure that all employees are thoroughly familiar with proper waste handling and emergency procedures, relevant to their responsibilities during normal facility operations and emergencies;

(iv) The emergency coordinator or his designee must respond to any emergencies that arise. The applicable responses are as follows:

(A) In the event of a fire, call the fire department or attempt to extinguish it using a fire extinguisher;

(B) In the event of a spill, the small quantity generator is responsible for containing the flow of hazardous waste to the extent possible, and as soon as is practicable, cleaning up the hazardous waste and any contaminated materials or soil. Such containment and cleanup can be conducted either by the small quantity generator or by a contractor on behalf of the small quantity generator;

(C) In the event of a fire, explosion, or other release that could threaten human health outside the facility or when the small quantity generator has knowledge that a spill has reached surface water, the small quantity generator must immediately notify the National Response Center (using their 24-hour toll free number 800-424-8802). The report must include the following information:

(1) The name, address, and EPA identification number of the small quantity generator;

(2) Date, time, and type of incident (e.g., spill or fire);

(3) Quantity and type of hazardous waste involved in the incident;

(4) Extent of injuries, if any; and

(5) Estimated quantity and disposition of recovered materials, if any.

(c) Transporting over two hundred (200) miles. A small quantity generator who must transport its waste, or offer its waste for transportation, over a distance of two hundred (200) miles or more for off-site treatment, storage or disposal may accumulate hazardous waste on site for two hundred seventy (270) days or less without a permit or without having interim status provided that the generator complies with the conditions of paragraph (b) of this section.

(d) Accumulation time limit extension. A small quantity generator who accumulates hazardous waste for more than one hundred eighty (180) days (or for more than two hundred seventy (270) days if it must transport its waste, or offer its waste for transportation, over a distance of two hundred (200) miles or more)

is subject to the requirements of R.61-79.264, 265, 268, and 270 of this chapter unless it has been granted an extension to the one hundred eighty (180)-day (or two hundred seventy (270)-day if applicable) period. Such extension may be granted by the Department if hazardous wastes must remain on site for longer than one hundred eighty (180) days (or two hundred seventy (270) days if applicable) due to unforeseen, temporary, and uncontrollable circumstances. An extension of up to thirty (30) days may be granted at the discretion of the Department on a case-by-case basis.

(e) Rejected load. A small quantity generator who sends a shipment of hazardous waste to a designated facility with the understanding that the designated facility can accept and manage the waste and later receives that shipment back as a rejected load or residue in accordance with the manifest discrepancy provisions of R.61-79.264.72 or 265.72 may accumulate the returned waste on site in accordance with paragraphs (a)-(d) of this section. Upon receipt of the returned shipment, the generator must:

(1) Sign Item 18c of the manifest, if the transporter returned the shipment using the original manifest;  
or

(2) Sign Item 20 of the manifest, if the transporter returned the shipment using a new manifest.

(f) A small quantity generator experiencing an episodic event may accumulate hazardous waste in accordance with R.61-79.262 subpart L in lieu of R.61-79.262.17.

**Revise 61-79.262 to add section 262.17 to read:**

### **262.17 Conditions for exemption for a large quantity generator that accumulates haza**

A large quantity generator may accumulate hazardous waste on site without a permit or interim status, and without complying with the requirements of R.61-79.124, 264 through 267, and 270, or the notification requirements of the SC Hazardous Waste Management Act Section 44-56-120 and section 3010 of RCRA, provided that all of the following conditions for exemption are met:

(a) Accumulation. A large quantity generator accumulates hazardous waste on site for no more than ninety (90) days, unless in compliance with the accumulation time limit extension or F006 accumulation conditions for exemption in paragraphs (b) through (e) of this section. The following accumulation conditions also apply:

(1) Accumulation of hazardous waste in containers. If the hazardous waste is placed in containers, the large quantity generator must comply with the following:

(i) Air emission standards. The applicable requirements of subparts AA, BB, and CC of R.61-79.265;

(ii) Condition of containers. If a container holding hazardous waste is not in good condition, or if it begins to leak, the large quantity generator must immediately transfer the hazardous waste from this container to a container that is in good condition, or immediately manage the waste in some other way that complies with the conditions for exemption of this section;

(iii) Compatibility of waste with container. The large quantity generator must use a container made of or lined with materials that will not react with, and are otherwise compatible with, the hazardous waste to be stored, so that the ability of the container to contain the waste is not impaired;

(iv) Management of containers.

(A) A container holding hazardous waste must always be closed during accumulation, except when it is necessary to add or remove waste.

(B) A container holding hazardous waste must not be opened, handled, or stored in a manner that may rupture the container or cause it to leak.

(v) Inspections. At least weekly, the large quantity generator must inspect central accumulation areas. The large quantity generator must look for leaking containers and for deterioration of containers caused by corrosion or other factors. See paragraph (a)(1)(ii) of this section for remedial action required if deterioration or leaks are detected.

(vi) Special conditions for accumulation of ignitable and reactive wastes.

(A) Containers holding ignitable or reactive waste must be located at least fifteen (15) meters (50 feet) from the facility's property line unless a written approval is obtained from the authority having jurisdiction over the local fire code allowing hazardous waste accumulation to occur within this restricted area. A record of the written approval must be maintained as long as ignitable or reactive hazardous waste is accumulated in this area.

(B) The large quantity generator must take precautions to prevent accidental ignition or reaction of ignitable or reactive waste. This waste must be separated and protected from sources of ignition or reaction including but not limited to the following: Open flames, smoking, cutting and welding, hot surfaces, frictional heat, sparks (static, electrical, or mechanical), spontaneous ignition (e.g., from heat-producing chemical reactions), and radiant heat. While ignitable or reactive waste is being handled, the large quantity generator must confine smoking and open flame to specially designated locations. "No Smoking" signs must be conspicuously placed wherever there is a hazard from ignitable or reactive waste.

(vii) Special conditions for accumulation of incompatible wastes.

(A) Incompatible wastes, or incompatible wastes and materials, (see appendix V of R.61-79.265 for examples) must not be placed in the same container, unless R.61-79.265.17(b) is complied with.

(B) Hazardous waste must not be placed in an unwashed container that previously held an incompatible waste or material (see appendix V of R.61-79.265 for examples), unless ~~section R.61-79.265.17(b)~~ is complied with.

(C) A container holding a hazardous waste that is incompatible with any waste or other materials accumulated or stored nearby in other containers, piles, open tanks, or surface impoundments must be separated from the other materials or protected from them by means of a dike, berm, wall, or other device.

(2) Accumulation of hazardous waste in tanks. If the waste is placed in tanks, the large quantity generator must comply with the applicable requirements of subpart J, except section 265.197(c) of Closure and post-closure care and R.61-79.265.200—Waste analysis and trial tests, as well as the applicable requirements of R.61-79.265 subparts AA, BB, and CC.

(3) Accumulation of hazardous waste on drip pads. If the hazardous waste is placed on drip pads, the large quantity generator must comply with the following:

(i) R.61-79.265 subpart W:

(ii) The large quantity generator must remove all wastes from the drip pad at least once every ninety (90) days. Any hazardous wastes that are removed from the drip pad are then subject to the ninety (90)-day accumulation limit in paragraph (a) of this section and R.61-79.262.15, if the hazardous wastes are being managed in satellite accumulation areas prior to being moved to a central accumulation area; and

(iii) The large quantity generator must maintain on site at the facility the following records readily available for inspection:

(A) A written description of procedures that are followed to ensure that all wastes are removed from the drip pad and associated collection system at least once every ninety (90) days; and

(B) Documentation of each waste removal, including the quantity of waste removed from the drip pad and the sump or collection system and the date and time of removal.

(4) Accumulation of hazardous waste in containment buildings. If the waste is placed in containment buildings, the large quantity generator must comply with R.61-79.265 subpart DD. The generator must label its containment building with the words “Hazardous Waste” in a conspicuous place easily visible to employees, visitors, emergency responders, waste handlers, or other persons on site, and also in a conspicuous place provide an indication of the hazards of the contents (examples include, but are not limited to, the applicable hazardous waste characteristic(s) (i.e., ignitable, corrosive, reactive, toxic); hazard communication consistent with the Department of Transportation requirements at 49 CFR part 172 subpart E (labeling) or subpart F (placarding); a hazard statement or pictogram consistent with the Occupational Safety and Health Administration Hazard Communication Standard at 29 CFR 1910.1200; or a chemical hazard label consistent with the National Fire Protection Association code 704). The generator must also maintain:

(i) The professional engineer certification that the building complies with the design standards specified in R.61-79.265.1101. This certification must be in the generator's files prior to operation of the unit; and

(ii) The following records by use of inventory logs, monitoring equipment, or any other effective means:

(A) A written description of procedures to ensure that each waste volume remains in the unit for no more than ninety (90) days, a written description of the waste generation and management practices for the facility showing that the generator is consistent with respecting the ninety (90) day limit, and documentation that the procedures are complied with; or

(B) Documentation that the unit is emptied at least once every ninety (90) days.

(C) Inventory logs or records with the above information must be maintained on site and readily available for inspection.

(5) Labeling and marking of containers and tanks—

(i) Containers. A large quantity generator must mark or label its containers with the following:

(A) The words “Hazardous Waste”;

(B) An indication of the hazards of the contents (examples include, but are not limited to, the applicable hazardous waste characteristic(s) (i.e., ignitable, corrosive, reactive, toxic); hazard

communication consistent with the Department of Transportation requirements at 49 CFR part 172 subpart E (labeling) or subpart F (placarding); a hazard statement or pictogram consistent with the Occupational Safety and Health Administration Hazard Communication Standard at 29 CFR 1910.1200; or a chemical hazard label consistent with the National Fire Protection Association code 704); and

(C) The date upon which each period of accumulation begins clearly visible for inspection on each container.

(ii) Tanks. A large quantity generator accumulating hazardous waste in tanks must do the following:

(A) Mark or label its tanks with the words "Hazardous Waste";

(B) Mark or label its tanks with an indication of the hazards of the contents (examples include, but are not limited to, the applicable hazardous waste characteristic(s) (i.e., ignitable, corrosive, reactive, toxic); hazard communication consistent with the Department of Transportation requirements at 49 CFR part 172 subpart E (labeling) or subpart F (placarding); a hazard statement or pictogram consistent with the Occupational Safety and Health Administration Hazard Communication Standard at 29 CFR 1910.1200; or a chemical hazard label consistent with the National Fire Protection Association code 704);

(C) Use inventory logs, monitoring equipment or other records to demonstrate that hazardous waste has been emptied within ninety (90) days of first entering the tank if using a batch process, or in the case of a tank with a continuous flow process, demonstrate that estimated volumes of hazardous waste entering the tank daily exit the tank within ninety (90) days of first entering; and

(D) Keep inventory logs or records with the above information on site and readily available for inspection.

(6) Emergency procedures. The large quantity generator complies with the standards in subpart M of this part, Preparedness, Prevention and Emergency Procedures for Large Quantity Generators.

(7) Personnel training.

(i)(A) Facility personnel must successfully complete a program of classroom instruction, online training (e.g., computer-based or electronic), or on-the-job training that teaches them to perform their duties in a way that ensures compliance with this part. The large quantity generator must ensure that this program includes all the elements described in the document required under paragraph (a)(7)(iv) of this section.

(B) This program must be directed by a person trained in hazardous waste management procedures, and must include instruction which teaches facility personnel hazardous waste management procedures (including contingency plan implementation) relevant to the positions in which they are employed.

(C) At a minimum, the training program must be designed to ensure that facility personnel are able to respond effectively to emergencies by familiarizing them with emergency procedures, emergency equipment, and emergency systems, including where applicable:

(1) Procedures for using, inspecting, repairing, and replacing facility emergency and monitoring equipment;

(2) Key parameters for automatic waste feed cut-off systems;

(3) Communications or alarm systems;

(4) Response to fires or explosions;

(5) Response to groundwater contamination incidents; and

(6) Shutdown of operations.

(D) For facility employees that receive emergency response training pursuant to Occupational Safety and Health Administration regulations 29 CFR 1910.120(p)(8) and 1910.120(q), the large quantity generator is not required to provide separate emergency response training pursuant to this section, provided that the overall facility training meets all the conditions of exemption in this section.

(ii) Facility personnel must successfully complete the program required in paragraph (a)(7)(i) of this section within six (6) months after the date of their employment or assignment to the facility, or to a new position at the facility, whichever is later. Employees must not work in unsupervised positions until they have completed the training standards of paragraph (a)(7)(i) of this section.

(iii) Facility personnel must take part in an annual review of the initial training required in paragraph (a)(7)(i) of this section.

(iv) The large quantity generator must maintain the following documents and records at the facility:

(A) The job title for each position at the facility related to hazardous waste management, and the name of the employee filling each job;

(B) A written job description for each position listed under paragraph (a)(7)(iv)(A) of this section. This description may be consistent in its degree of specificity with descriptions for other similar positions in the same company location or bargaining unit, but must include the requisite skills, education, or other qualifications, and duties of facility personnel assigned to each position;

(C) A written description of the type and amount of both introductory and continuing training that will be given to each person filling a position listed under paragraph (a)(7)(iv)(A) of this section;

(D) Records that document that the training or job experience, required under paragraphs (a)(7)(i), (ii), and (iii) of this section, has been given to, and completed by, facility personnel.

(v) Training records on current personnel must be kept until closure of the facility. Training records on former employees must be kept for at least three (3) years from the date the employee last worked at the facility. Personnel training records may accompany personnel transferred within the same company.

(8) Closure. A large quantity generator accumulating hazardous wastes in containers, tanks, drip pads, and containment buildings, prior to closing a unit at the facility, or prior to closing the facility, must meet the following conditions:

(i) Notification for closure of a waste accumulation unit. A large quantity generator must perform one of the following when closing a waste accumulation unit:

(A) Place a notice in the operating record within thirty (30) days after closure identifying the location of the unit within the facility; or

(B) Meet the closure performance standards of paragraph (a)(8)(iii) of this section for container, tank, and containment building waste accumulation units or paragraph (a)(8)(iv) of this section for drip pads and notify the Department following the procedures in paragraph (a)(8)(ii)(B) of this section for the waste accumulation unit. If the waste accumulation unit is subsequently reopened, the generator may remove the notice from the operating record.

(ii) Notification for closure of the facility.

(A) Notify the Department using Form 8700-12 no later than thirty (30) days prior to closing the facility.

(B) Notify the Department using Form 8700-12 within ninety (90) days after closing the facility that it has complied with the closure performance standards of paragraph (a)(8)(iii) or (iv) of this section. If the facility cannot meet the closure performance standards of paragraph (a)(8)(iii) or (iv) of this section, notify the Department using Form 8700-12 that it will close as a landfill under R.61-79.265.310 of this chapter in the case of a container, tank or containment building unit(s), or for a facility with drip pads, notify using Form 8700-12 that it will close under the standards of R.61-79.265.445(b).

(C) A large quantity generator may request additional time to clean close, but it must notify the Department using form 8700-12 within 75 days after the date provided in paragraph (a)(8)(ii)(A) of this section to request an extension and provide an explanation as to why the additional time is required.

(iii) Closure performance standards for container, tank systems, and containment building waste accumulation units.

(A) At closure, the generator must close the waste accumulation unit or facility in a manner that:

(1) Minimizes the need for further maintenance by controlling, minimizing, or eliminating, to the extent necessary to protect human health and the environment, the post-closure escape of hazardous waste, hazardous constituents, leachate, contaminated run-off, or hazardous waste decomposition products to the ground or surface waters or to the atmosphere.

(2) Removes or decontaminates all contaminated equipment, structures and soil and any remaining hazardous waste residues from waste accumulation units including containment system components (pads, liners, etc.), contaminated soils and subsoils, bases, and structures and equipment contaminated with waste, unless R.61-79.261.3(d) applies.

(3) Any hazardous waste generated in the process of closing either the generator's facility or unit(s) accumulating hazardous waste must be managed in accordance with all applicable standards of R.61-79.262, 263, 265, and 268 of this chapter, including removing any hazardous waste contained in these units within ninety (90) days of generating it and managing these wastes in a C hazardous waste permitted treatment, storage and disposal facility or interim status facility.

(4) If the generator demonstrates that any contaminated soils and wastes cannot be practicably removed or decontaminated as required in paragraph (a)(8)(ii)(A)(2) of this section, then the waste accumulation unit is considered to be a landfill and the generator must close the waste accumulation unit and perform post-closure care in accordance with the closure and post-closure care requirements that apply to landfills (R.61-79.265.310). In addition, for the purposes of closure, post-closure, and financial responsibility, such a waste accumulation unit is then considered to be a landfill, and the generator must meet all of the requirements for landfills specified in R.61-79.265 subparts G and H.



(iv) Closure performance standards for drip pad waste accumulation units. At closure, the generator must comply with the closure requirements of paragraphs (a)(8)(ii) and (a)(8)(iii)(A)( 1) and ( 3) of this section, and R.61-79.265.445(a) and (b).

(v) The closure requirements of paragraph (a)(8) of this section do not apply to satellite accumulation areas.

(9) Land disposal restrictions. The large quantity generator complies with all applicable requirements under R.61-79.268.

(b) Accumulation time limit extension. A large quantity generator who accumulates hazardous waste for more than ninety (90) days is subject to the requirements of R.61-79.124, 264 through 268, and 270, and the notification requirements of the SC Hazardous Waste Management Act Section 44-56-120 and section 3010 of RCRA, unless it has been granted an extension to the ninety (90)-day period. Such extension may be granted by the Department if hazardous wastes must remain on site for longer than ninety (90) days due to unforeseen, temporary, and uncontrollable circumstances. An extension of up to thirty (30) days may be granted at the discretion of the Department on a case-by-case basis.

(c) Accumulation of F006. A large quantity generator who also generates wastewater treatment sludges from electroplating operations that meet the listing description for the EPA hazardous waste number F006, may accumulate F006 waste on site for more than 90 days, but not more than 180 days without being subject to R.61-79.124, 264 through 267, and 270, and the notification requirements of the SC Hazardous Waste Management Act Section 44-56-120 and section 3010 of RCRA, provided that it complies with all of the following additional conditions for exemption:

(1) The large quantity generator has implemented pollution prevention practices that reduce the amount of any hazardous substances, pollutants, or contaminants entering F006 or otherwise released to the environment prior to its recycling;

(2) The F006 is legitimately recycled through metals recovery;

(3) No more than twenty thousand (20,000) kilograms of F006 waste is accumulated on site at any one time; and

(4) The F006 waste is managed in accordance with the following:

(i)(A) If the F006 waste is placed in containers, the large quantity generator must comply with the applicable conditions for exemption in paragraph (a)(1) of this section; and/or

(B) If the F006 is placed in tanks, the large quantity generator must comply with the applicable conditions for exemption of paragraph (a)(2) of this section; and/or

(C) If the F006 is placed in containment buildings, the large quantity generator must comply with R.61-79.265 subpart DD, and has placed its professional engineer certification that the building complies with the design standards specified in R.61-79.265.1101 in the facility's files prior to operation of the unit. The large quantity generator must maintain the following records:

(1) A written description of procedures to ensure that the F006 waste remains in the unit for no more than one hundred eighty (180) days, a written description of the waste generation and management practices for the facility showing that they are consistent with the one hundred eighty (180)-day limit, and documentation that the large quantity generator is complying with the procedures; or

(2) Documentation that the unit is emptied at least once every one hundred eighty (180) days.

(ii) The large quantity generator is exempt from all the requirements in R.61-79.265 subparts G and H, except for those referenced in paragraph (a)(8) of this section.

(iii) The date upon which each period of accumulation begins is clearly marked and must be clearly visible for inspection on each container;

(iv) While being accumulated on site, each container and tank is labeled or marked clearly with:

(A) The words "Hazardous Waste"; and

(B) An indication of the hazards of the contents (examples include, but are not limited to, the applicable hazardous waste characteristic(s) (i.e., ignitable, corrosive, reactive, toxic); hazard communication consistent with the Department of Transportation requirements at 49 CFR part 172 subpart E (labeling) or subpart F (placarding); a hazard statement or pictogram consistent with the Occupational Safety and Health Administration Hazard Communication Standard at 29 CFR 1910.1200; or a chemical hazard label consistent with the National Fire Protection Association code 704).

(v) The large quantity generator complies with the requirements in paragraphs (a)(6) and (7) of this section.

(d) F006 transported over two hundred (200) miles. A large quantity generator who also generates wastewater treatment sludges from electroplating operations that meet the listing description for the EPA hazardous waste number F006, and who must transport this waste, or offer this waste for transportation, over a distance of two hundred (200) miles or more for off-site metals recovery, may accumulate F006 waste on site for more than ninety (90) days, but not more than two hundred seventy (270) days without being subject to R.61-79.124, 264 through 266, 270, and the notification requirements of the SC Hazardous Waste Management Act section 44-56-120 and section 3010 of RCRA, if the large quantity generator complies with all of the conditions for exemption of paragraphs (c)(1) through (4) of this section.

(e) F006 accumulation time extension. A large quantity generator accumulating F006 in accordance with paragraphs (c) and (d) of this section who accumulates F006 waste on site for more than one hundred eighty (180) days (or for more than two hundred seventy (270) days if the generator must transport this waste, or offer this waste for transportation, over a distance of two hundred (200) miles or more), or who accumulates more than twenty thousand (20,000) kilograms of F006 waste on site is an operator of a storage facility and is subject to the requirements of R.61-79.124, 264, 265, and 270 of this chapter, and the notification requirements of the SC Hazardous Waste Management Act Section 44-56-120 and section 3010 of RCRA, unless the generator has been granted an extension to the one hundred eighty (180)-day (or two hundred seventy (270)-day if applicable) period or an exception to the twenty thousand (20,000) kilogram accumulation limit. Such extensions and exceptions may be granted by the Department if F006 waste must remain on site for longer than one hundred eighty (180) days (or two hundred seventy (270) days if applicable) or if more than twenty thousand (20,000) kilograms of F006 waste must remain on site due to unforeseen, temporary, and uncontrollable circumstances. An extension of up to thirty (30) days or an exception to the accumulation limit may be granted at the discretion of the Department on a case-by-case basis.

(f) Consolidation of hazardous waste received from very small quantity generators. Large quantity generators may accumulate on site hazardous waste received from very small quantity generators under control of the same person (as defined in R.61-79.260.10), without a storage permit or interim status and

without complying with the requirements of R.61-79.124, 264 through 268, and 270, and the notification requirements of the SC Hazardous Waste Management Act Section 44-56-120 and section 3010 of RCRA, provided that they comply with the following conditions. “Control,” for the purposes of this section, means the power to direct the policies of the generator, whether by the ownership of stock, voting rights, or otherwise, except that contractors who operate generator facilities on behalf of a different person shall not be deemed to “control” such generators.

(1) The large quantity generator notifies the Department at least thirty (30) days prior to receiving the first shipment from a very small quantity generator(s) using EPA Form 8700-12; and

(i) Identifies on the form the name(s) and site address(es) for the very small quantity generator(s) as well as the name and business telephone number for a contact person for the very small quantity generator(s); and

(ii) Submits an updated Site ID form (EPA Form 8700-12) within thirty (30) days after a change in the name or site address for the very small quantity generator.

(2) The large quantity generator maintains records of shipments for three (3) years from the date the hazardous waste was received from the very small quantity generator. These records must identify the name, site address, and contact information for the very small quantity generator and include a description of the hazardous waste received, including the quantity and the date the waste was received.

(3) The large quantity generator complies with the independent requirements identified in section 262.10(a)(1)(iii) and the conditions for exemption in this section for all hazardous waste received from a very small quantity generator. For purposes of the labeling and marking regulations in paragraph (a)(5) of this section, the large quantity generator must label the container or unit with the date accumulation started (i.e., the date the hazardous waste was received from the very small quantity generator). If the large quantity generator is consolidating incoming hazardous waste from a very small quantity generator with either its own hazardous waste or with hazardous waste from other very small quantity generators, the large quantity generator must label each container or unit with the earliest date any hazardous waste in the container was accumulated on site.

(g) Rejected load. A large quantity generator who sends a shipment of hazardous waste to a designated facility with the understanding that the designated facility can accept and manage the waste and later receives that shipment back as a rejected load or residue in accordance with the manifest discrepancy provisions of R.61-79.264.72 or 265.72 may accumulate the returned waste on site in accordance with paragraphs (a) and (b) of this section. Upon receipt of the returned shipment, the generator must:

(1) Sign Item 18c of the manifest, if the transporter returned the shipment using the original manifest; or

(2) Sign Item 20 of the manifest, if the transporter returned the shipment using a new manifest.

**Revise 61-79.262 to add section 262.18 to read:**

**262.18 EPA identification numbers and renotification for small quantity generators.**

(a) A generator must not treat, store, dispose of, transport, or offer for transportation, hazardous waste without having received an EPA identification number from the Department.

(b) A generator who has not received an EPA identification number must obtain one by applying to the Department using EPA Form 8700-12. Upon receiving the request, the Department will assign an EPA identification number to the generator.

(c) A generator must not offer its hazardous waste to transporters or to treatment, storage, or disposal facilities that have not received an EPA identification number.

(d) Renotification.

(1) A small quantity generator must renotify the Department starting in 2021 and every four (4) years thereafter using EPA Form 8700-12. This renotification must be submitted by September 1<sup>st</sup> of each year in which renotifications are required.

(2) A large quantity generator must renotify the Department by March 1<sup>st</sup> of each even-numbered year thereafter using EPA Form 8700-12. A large quantity generator may submit this renotification as part of its Quarterly Reporting required under section 262.41.

(e) A recognized trader must not arrange for import or export of hazardous waste without having received an EPA identification number from the Department.

**Revise 61-79.262 Subpart B title to read:**

**SUBPART B: The Manifest Requirements Applicable to Small and Large Quantity Generators**

**Revise 61-79.262 Subpart C title to read:**

**SUBPART C: Pre-Transport Requirements Applicable to Small and Large Quantity Generators**

**Revise 61-79.262.32(b) to add 262.32(b)(1) to 262.32(b)(5) to read:**

(b) Before transporting hazardous waste or offering hazardous waste for transportation off-site, a generator must mark each container of 119 gallons or less used in such transportation with the following words and information in accordance with the requirements of 49 CFR 172.304.:

(1) HAZARDOUS WASTE - Federal Law Prohibits Improper Disposal. If found, contact the nearest police or public safety authority or the U.S. Environmental Protection Agency.

(2) Generator's Name and Address

(3) Generator's EPA Identification Number

(4) Manifest Tracking Number

(5) EPA Hazardous Waste Number(s)

**Revise 62-79.262.32 to add 262.32(c) and 262.32(d) to read:**

(c) A generator may use a nationally recognized electronic system, such as bar coding, to identify the EPA Hazardous Waste Number(s), as required by paragraph (b)(5) or paragraph (d).

(d) Lab packs that will be incinerated in compliance with section 268.42(c) are not required to be marked with EPA Hazardous Waste Number(s), except D004, D005, D006, D007, D008, D010, and D011, where applicable.

## **Revise 61-79.262.34 to remove and reserve it:**

### **262.34 Accumulation time.**

~~—(a) Except as provided in paragraphs (d), and (f) of this section, a generator may accumulate hazardous waste onsite for 90 days or less without a permit or without having interim status, provided that: (5/93)~~

~~—(1) The waste is placed:~~

~~—(i) In containers and the generator complies with the applicable requirements of subparts I, AA, BB, and CC of 265; and/or~~

~~—(ii) In tanks and the generator complies with the applicable requirements of subparts J, AA, BB, and CC of 265 except 265.197(c) and 265.200; and/or~~

~~—(iii) On drip pads and the generator complies with subpart W of 265 and maintains the following records at the facility:~~

~~—(A) A description of procedures that will be followed to ensure that all wastes are removed from the drip pad and associated collection system at least once every 90 days; and~~

~~—(B) Documentation of each waste removal, including the quantity of waste removed from the drip pad and the sump or collection system and the date and time of removal; and/or~~

~~—(iv) In containment buildings and the generator complies with subpart DD of 265, has placed its professional engineer certification that the building complies with the design standards specified in 265.1101 in the facility's operating record no later than 60 days after the date of initial operation of the unit. After February 18, 1993, PE certification will be required prior to operation of the unit. The owner or operator shall maintain the following records at the facility:~~

~~—(A) A written description of procedures to ensure that each waste volume remains in the unit for no more than 90 days, a written description of the waste generation and management practices for the facility showing that they are consistent with respecting the 90 day limit, and documentation that the procedures are complied with; or~~

~~—(B) Documentation that the unit is emptied at least once every 90 days.~~

~~—(v) In addition, such a generator is exempt from all the requirements in subparts G and H of R.61-79.265, except for 265.111 and 265.114.~~

~~—(2) The date upon which each period of accumulation begins is clearly marked and visible for inspection on each container.~~

~~—(3) While being accumulated onsite, each container and tank is labeled or marked clearly with the EPA Hazardous Waste Number and the words: "Hazardous Waste— federal laws prohibit improper disposal."~~

~~—(4) The generator complies with the requirements for owners or operators in subparts C and D in R.61-79.265, with 265.15(d) and 265.16, and with all applicable requirements under part 268.~~

~~—(5) A generator may not stack containers of hazardous waste more than two containers high without first obtaining written approval from the Department. This requirement will become effective 90 days after publication in the State Register.~~

~~—(b) A generator who accumulates 1,000 kilograms or greater of hazardous waste in a calendar month, or greater than 1 kilogram of acute hazardous waste listed in 261.31 or 261.33(e) in a calendar month, who accumulates hazardous waste or acute hazardous waste for more than 90 days is an operator of a storage facility and is subject to the requirements of parts 264 and 265, and the permit requirements of 270 unless he has been granted an extension to the 90-day period. Such extension may be granted by the Department if hazardous wastes must remain on site for longer than 90 days due to unforeseen, temporary, and uncontrollable circumstances. An extension of up to 30 days may be granted at the discretion of the Department on a case-by-case basis.~~

~~—(e)(1) A generator may accumulate as much as 55 gallons of hazardous waste or one quart of acutely hazardous waste listed in 261.31 or 261.33(e) in containers at or near any point of generation where wastes initially accumulate, which is under the control of the operator of the process generating the waste, without a permit or interim status and without complying with paragraph (a) or (d) of this section provided he:~~

~~—(i) Complies with R.61-79.265 Sections 265.171, 265.172, and 265.173(a) of these Regulations; and~~

~~—(ii) Marks his containers either with the words: "HAZARDOUS WASTE" or with other words that identify the contents of the container.~~

~~—(iii) Complies with R.61-79.265.16(a)(1) and (d)(4). The requirements of R.61-79.265.16(a) must be repeated as necessary when there is a change in the hazardous waste being accumulated.~~

~~—(2) A generator who accumulates either hazardous waste or acutely hazardous waste listed in 261.31 or 261.33(e) in excess of the amounts listed in paragraph (c)(1) of this section at or near any point of generation must, with respect to that amount of excess waste, comply within three days with paragraph (a) of this section or other applicable provisions. During the three-day period the generator must continue to comply with paragraphs (c)(1)(i) and (ii) of this section. The generator must mark the container holding the excess accumulation of hazardous waste with the date the excess amount began accumulating.~~

~~—(d) A generator who generates greater than 100 kilograms but less than 1000 kilograms of hazardous waste in a calendar month may accumulate hazardous waste onsite for 180 days or less without a permit or without having interim status [see 262.40(e)] provided that: (amended 6/89)~~

~~—(1) The quantity of waste accumulated onsite never exceeds 6000 kilograms;~~

~~—(2) The generator complies with the requirements of subpart I of R.61-79.265, except 265.175, .176, and 178.~~

~~—(3) The generator complies with the requirements of Subpart J, R.61-79.265.201.~~

~~—(4) The generator complies with the requirements of paragraphs (a)(2) and (a)(3) of this section, the requirements of subpart C of R.61-79.265, the requirements of all applicable requirements under part 268; and~~

~~— (5) The generator complies with the following requirements:~~

~~— (i) At all times there must be at least one employee either on the premises or on call (i.e., available to respond to an emergency by reaching the facility within a short period of time) with the responsibility for coordinating all emergency response measures specified in paragraph (d)(5)(iv) of this section. This employee is the emergency coordinator. (amended 11/90)~~

~~— (ii) The generator must post the following information next to the telephone:~~

~~— (A) The name and telephone number of the emergency coordinator;~~

~~— (B) Location of fire extinguishers and spill control material, and if present, fire alarm; and~~

~~— (C) The telephone number of the fire department, unless the facility has a direct alarm.~~

~~— (iii) The generator must ensure that all employees are thoroughly familiar with proper waste handling and emergency procedures, relevant to their responsibilities during normal facility operations and emergencies:~~

~~— (iv) The emergency coordinator or his designee must respond to any emergencies that arise. The applicable responses are as follows:~~

~~— (A) In the event of a fire, call the fire department or attempt to extinguish it using a fire extinguisher;~~

~~— (B) In the event of a spill, contain the flow of hazardous waste to the extent possible, and as soon as is practicable, clean up the hazardous waste and any contaminated materials or soil;~~

~~— (C) In the event of a fire, explosion, other release which could threaten human health outside the facility or when the generator has knowledge that a spill has reached surface water, the generator must immediately notify the National Response Center (using their 24-hour toll free number 800/424-8802) and the Department emergency response number 803/253-6488. The report must include the following information:~~

~~— 1. The name, address, and U.S. EPA Identification Number of the generator;~~

~~— 2. Date, time, and type of incident (i.e., spill or fire);~~

~~— 3. Quantity and type of hazardous waste involved in the incident;~~

~~— 4. Extent of injuries, if any; and~~

~~— 5. Estimated quantity and disposition of recovered materials, if any.~~

~~— (6) The generator complies with R.61-79.262.34(e) except for 262.34(e)(1)(iii).~~

~~— (e) A generator who generates greater than 100 kilograms but less than 1000 kilograms of hazardous waste in a calendar month and who must transport his waste, or offer his waste for transportation, over a distance of 200 miles or more for off-site treatment, storage or disposal may accumulate hazardous waste on-site for 270 days or less without a permit or without having interim status provided that he complies with the requirements of paragraph (d) of this section.~~

~~— (f) A generator who generates greater than 100 kilograms but less than 1000 kilograms of hazardous waste in a calendar month and who accumulates hazardous waste in quantities exceeding 6000 kilograms or accumulates hazardous waste for more than 180 days (or for more than 270 days if he must transport his waste, or offer his waste for transportation, over a distance of 200 miles or more) is an operator of a storage facility and is subject to the requirements of R.61-79.264 and R.61-79.265, and the permit requirements of R.61-79.270 unless he has been granted an extension to the 180-day (or 270-day if applicable) period. Such extension may be granted by the Department if hazardous wastes must remain on-site for longer than 180 days (or 270 days if applicable) due to unforeseen, temporary, and uncontrollable circumstances. An extension of up to 30 days may be granted at the discretion of the Department on a case-by-case basis.~~

~~— (g) A generator who generates 1,000 kilograms or greater of hazardous waste per calendar month who also generates wastewater treatment sludges from electroplating operations that meet the listing description for the RCRA hazardous waste code F006, may accumulate F006 waste on-site for more than 90 days, but not more than 180 days without a permit or without having interim status provided that:~~

~~— (1) The generator has implemented pollution prevention practices that reduce the amount of any hazardous substances, pollutants or contaminants entering F006 or otherwise released to the environment prior to its recycling;~~

~~— (2) The F006 waste is legitimately recycled through metals recovery;~~

~~— (3) No more than 20,000 kilograms of F006 waste is accumulated on-site at any one time; and~~

~~— (4) The F006 waste is managed in accordance with the following:~~

~~— (i) The F006 waste is placed:~~

~~— (A) In containers and the generator complies with the applicable requirements of subparts I, AA, BB, and CC of part 265; and/or~~

~~— (B) In tanks and the generator complies with the applicable requirements of subparts J, AA, BB, and CC of part 265, except 265.197(c) and 265.200; and/or 262.34(g)(4)(i)(C)~~

~~— (C) In containment buildings and the generator complies with subpart DD of part 265, and has placed its professional engineer certification that the building complies with the design standards specified in 265.1101 in the facility's operating record prior to operation of the unit. The owner or operator must maintain the following records at the facility:~~

~~— (1) A written description of procedures to ensure that the F006 waste remains in the unit for no more than 180 days, a written description of the waste generation and management practices for the facility showing that they are consistent with the 180-day limit, and documentation that the generator is complying with the procedures; or~~

~~— (2) Documentation that the unit is emptied at least once every 180 days.~~

~~— (ii) In addition, such a generator is exempt from all the requirements in subparts G and H of part 265, except for 265.111 and 265.114.~~

~~— (iii) The date upon which each period of accumulation begins is clearly marked and visible for inspection on each container;~~



~~—(iv) While being accumulated on site, each container and tank is labeled or marked clearly with the words, "Hazardous Waste;" and~~

~~—(v) The generator complies with the requirements for owners or operators in subparts C and D in part 265, with 265.16, and with 268.7(a)(5).~~

~~—(h) [Reserved]~~

~~—(i) A generator accumulating F006 in accordance with paragraphs (g) and (h) of this section who accumulates F006 waste on site for more than 180 days, or who accumulates more than 20,000 kilograms of F006 waste on site is an operator of a storage facility and is subject to the requirements of parts 264 and 265 and the permit requirements of part 270 unless the generator has been granted an extension to the 180-day period or an exception to the 20,000 kilogram accumulation limit. Such extensions and exceptions may be granted if F006 waste must remain on site for longer than 180 days or if more than 20,000 kilograms of F006 waste must remain on site due to unforeseen, temporary, and uncontrollable circumstances. An extension of up to 30 days or an exception to the accumulation limit may be granted at the discretion of the Bureau on a case-by-case basis.~~

~~—(j) [Reserved]~~

~~—(k) [Reserved]~~

~~—(l) [Reserved]~~

~~—(m) A generator who sends a shipment of hazardous waste to a designated facility with the understanding that the designated facility can accept and manage the waste and later receives that shipment back as a rejected load or residue in accordance with the manifest discrepancy provisions of 264.72 or 265.72 of this chapter may accumulate the returned waste on site in accordance with paragraphs (a) and (b) or (d), (e) and (f) of this section, depending on the amount of hazardous waste on site in that calendar month. Upon receipt of the returned shipment, the generator must:~~

~~—(1) Sign Item 18c of the manifest, if the transporter returned the shipment using the original manifest; or~~

~~—(2) Sign Item 20 of the manifest, if the transporter returned the shipment using a new manifest. [Reserved]~~

**Revise 61-79.262 to add section 262.35 to read:**

**262.35 [Reserved] Liquids in landfills prohibition.**

The placement of bulk or non-containerized liquid hazardous waste or hazardous waste containing free liquids (whether or not sorbents have been added) in any landfill is prohibited. Prior to disposal in a hazardous waste landfill, liquids must meet additional requirements as specified in R.61-79.264.314 and 265.314.

**Revise 61-79.262 Subpart D title to read:**

**SUBPART D: Recordkeeping and Reporting Applicable to Small and Large Quantity Gen**

**Revise 61-79.262.40(c) to read:**

~~(c) A generator must keep records onsite of any test results, waste analyses, or other determinations made in accordance with R.61-79.262.11 for at least three years from the date that the waste was last sent to onsite or offsite treatment, storage, or disposal. See R.61-79.262.11(f) for recordkeeping requirements for documenting hazardous waste determinations.~~

**Revise 61-79.262.41 to read:**

(b) Any generator must submit the information required by paragraph (a) on a form designated by the Department and according to the instructions included with such form. Reporting for exports of hazardous waste is not required on the Report form. A separate annual report requirement is set forth at ~~262.56~~ section 262.83(g) for hazardous waste exporters.

~~(c) [moved to 262.45-12/93] Exports of hazardous waste to foreign countries are not required to be reported on the Quarterly Report form. A separate annual report requirement is set forth at R.61-79.262.83(g) for hazardous waste exporters.~~

**Revise 61-79.262.43 to read:**

~~—(a) Any generator within the State who treats or disposes or stores hazardous wastes onsite for more than ninety (90) days shall also comply with the reporting requirements of R.61-79.264.75 or R.61-79.265.75.~~

~~—(b) The Department may require, as deemed necessary, generators to furnish additional reports concerning the quantities and disposition of wastes identified or listed in R.61-79.261.~~

~~—(c) With the fourth quarter's report, a description of the efforts undertaken during the year to reduce the volume and toxicity of wastes generated;~~

~~—(d) With the fourth quarter's report, a description of the changes in volume and toxicity of wastes actually achieved during the year in comparison to previous years to the extent such information is available for years prior to 1984. The Department may require generators to furnish additional reports concerning the quantities and disposition of wastes identified or listed in R.61-79.261.~~

**Revise 61-79.262.44 Introductory; subitems (a) through (d) remain the same, to read:**

**262.44 Special requirements for generators of between 100 and 1000 kg/mo Recordkeeping quantity generators.**

A small quantity generator of greater than 100 kilograms but less than 1000 kilograms of hazardous waste ~~in a calendar month~~ is subject only to the following independent requirements of this ~~S~~subpart:

**Revise 61-79.262.200 to remove the definition of “Central Accumulation Area.”**

~~—“Central Accumulation Area” means an on-site hazardous waste accumulation area subject to either 262.34(a) (b) of this part (large quantity generators) or 262.34(d) (f) of this part (small quantity generators). A central accumulation area at an eligible academic entity that chooses to be subject to this subpart must also comply with 262.211 when accumulating unwanted material and/or hazardous waste.~~

**Revise 61-79.262.200 definition for “Trained professional” to read:**

**"Trained professional"** is a person who has completed the applicable RCRA training requirements of ~~265.16 R.61-79.262.17~~ for large quantity generators, or is knowledgeable about normal operations and emergencies in accordance with ~~262.34(d)(5)(iii)~~ section R.61-79.262.16 for small quantity generators and ~~conditionally exempt~~ very small quantity generators. A trained professional may be an employee of the eligible academic entity or may be a contractor or vendor who meets the requisite training requirements.

**Revise 61-79.262.201 to read:**

(a) Large quantity generators and small quantity generators This subpart provides alternative requirements to the requirements in R.61-79.262.11 and ~~262.34(e)~~ 262.15 for the hazardous waste determination and accumulation of hazardous waste in laboratories owned by eligible academic entities that choose to be subject to this subpart, provided that they complete the notification requirements of R.61-79.262.203.

(b) ~~Conditionally exempt~~ Very small quantity generators. This subpart provides alternative requirements to the conditional exemption in ~~261.5(b)~~ R.61-79.262.14 for the accumulation of hazardous waste in laboratories owned by eligible academic entities that choose to be subject to this subpart, provided that they complete the notification requirements of R.61-79.262.203.

**Revise 61-79.262.202 to read:**

(a) Large quantity generators and small quantity generators: Eligible academic entities have the option of complying with this subpart with respect to its laboratories, as an alternative to complying with the requirements of R.61-79.262.11 and ~~262.34(e)~~ 262.15.

(b) ~~Conditionally exempt~~ Very small quantity generators. Eligible academic entities have the option of complying with this subpart with respect to its laboratories, as an alternative to complying with the conditional exemption of ~~261.5(b)~~ R.61-79.262.14.

**Revise 61-79.262.203(a) to read:**

(a) An eligible academic entity must notify the Department in writing, using ~~Department's Notification and Reporting Form (DHEC Form 2701)~~ the RCRA Subtitle C Site Identification Form (EPA Form 8700-12), that it is electing to be subject to the requirements of this subpart for all the laboratories owned by the eligible academic entity under the same EPA identification number. An eligible academic entity that is a very small quantity generator and does not have an EPA identification number must notify that it is electing to be subject to the requirements of this subpart for all the laboratories owned by the eligible academic entity that are on site, as defined by R.61-79.260.10. An eligible academic entity must submit a separate notification (Site Identification Form) for each EPA identification number (or site, for very small quantity generators) that is electing to be subject to the requirements of this subpart, and must submit the Site Identification Form before it begins operating under this subpart.

**Revise 61-79.262.203(b)(2) to read:**

(2) Site EPA Identification Number (except for ~~conditionally exempt~~ very small quantity generators).

**Revise 61-79.262.204(a) to read:**

(a) An eligible academic entity must notify the Department in writing, using the ~~Department's Notification and Reporting Form (DHEC Form 2701)~~ RCRA Subtitle C Site Identification Form (EPA Form

8700-12), that it is electing to no longer be subject to the requirements of this subpart for all the laboratories owned by the eligible academic entity under the same EPA Identification Number and that it will comply with the requirements of R.61-79.262.11 and ~~262.34(e)~~262.15 for small quantity generators and large quantity generators. An eligible academic entity that is a ~~conditionally exempt~~very small quantity generator and does not have an EPA identification number must notify that it is withdrawing from the requirements of this subpart for all the laboratories owned by the eligible academic entity that are on-site and that it will comply with the conditional exemption in ~~261.5(b)~~R.61-79.262.14. An eligible academic entity must submit a separate notification (Site Identification Form) for each EPA Identification Number (or site, for ~~conditionally exempt~~very small quantity generators) that is withdrawing from the requirements of the subpart and must submit the Site Identification Form before it begins operating under the requirements of R.61-79.262.11 and ~~262.34(e)~~262.15 for small quantity generators and large quantity generators, or ~~261.5(b)~~R.61-79.262.14 for ~~conditionally exempt~~very small quantity generators.

**Revise 61-79.262.204(b)(2) to read:**

(2) Site EPA Identification Number (except for ~~conditionally exempt~~very small quantity generators).

**Revise 61-79.262.206(b)(3)(iii) to read:**

(iii) When venting of a container is necessary:

**Revise 61-79.262.207(d)(2) to read:**

(2) Make the hazardous waste determination, pursuant to section 262.11(a) through (d), for unwanted material.

**Revise 61-79.262.208(a) to read:**

(1) Remove all containers of unwanted material from each laboratory on a regular interval, not to exceed ~~6~~twelve (12) months; or

(2) Remove containers of unwanted material from each laboratory within ~~6~~twelve (12) months of each container's accumulation start date.

**Revise 61-79.262.208(d)(2) to read:**

(2) If a laboratory accumulates more than 1 quart of liquid reactive acutely hazardous unwanted material or more than one (1) kilogram (2.2 pounds) of solid reactive acutely hazardous unwanted material before the regularly scheduled removal, then the eligible academic entity must ensure that all containers of reactive acutely hazardous unwanted material:

(i) Are marked on the label that is associated with the container (or on the label that is affixed or attached to the container, if that is preferred) with the date that one (1) quart or one (1) kilogram is exceeded; and

(ii) Are removed from the laboratory within ten (10) calendar days of the date that one (1) quart or one (1) kilogram was exceeded, or at the next regularly scheduled removal, whichever comes first.

**Revise 61-79.262.209(b) to read:**

(b) ~~Conditionally exempt~~ Very small quantity generators - an eligible academic entity must ensure that a trained professional makes a hazardous waste determination, pursuant to section 262.11(a) through (d), for unwanted material in the laboratory before the unwanted material is removed from the laboratory, in accordance with R.61-79.262.210.

**Revise 61-79.262.210(a) to read:**

(a) A trained professional must make the hazardous waste determination, pursuant to R.61-79.262.11(a) through (d), before the unwanted material is removed from the laboratory.

**Revise 61-79.262.210(b)(3) to read:**

(3) Count the hazardous waste toward the eligible academic entity's generator ~~status~~category, pursuant to ~~261.5(e) and (d)~~R.61-79.262.13, in the calendar month that the hazardous waste determination was made.

**Revise 61-79.262.210(d)(2) to read:**

(2) ~~Conditionally exempt~~ Very small quantity generators must ensure it is taken directly from the laboratory(ies) to any of the types of facilities listed in ~~261.5(f)(3) for acute hazardous waste, or 261.5(g)(3) for hazardous waste~~R.61-79.262.14.

**Revise 61-79.262.211(c) to read:**

(c) The unwanted material becomes subject to the generator accumulation regulations of ~~262.34(a)~~R.61-79.262.16 for ~~large~~small quantity generators or ~~262.34(d)-(f)~~R.61-79.262.17 for ~~small~~large quantity generators as soon as it arrives in the central accumulation area, except for the "hazardous waste" labeling requirements of ~~262.34(a)(3)~~sections 262.16(b)(6) and 262.17(a)(5).

**Revise 61-79.262.211(d) to read:**

(d) A trained professional must determine, pursuant to R.61-79.262.11(a) through (d), if the unwanted material is a hazardous waste within four (4) calendar days of the unwanted materials' arrival at the on-site central accumulation area.

**Revise 61-79.262.211(e)(3) to read:**

(3) Count the hazardous waste toward the eligible academic entity's generator ~~status~~category, pursuant to ~~261.5(e) and (d)~~R.61-79.262.13 in the calendar month that the hazardous waste determination was made, and

**Revise 61-79.262.212(d) to read:**

(d) A trained professional must determine, pursuant to R.61-79.262.11(a) through (d), if the unwanted material is a hazardous waste within four (4) calendar days of the unwanted materials' arrival at an on-site interim status or permitted treatment, storage or disposal facility.

**Revise 61-79.262.213(a) to read:**

(1) If the volume of unwanted material in the laboratory exceeds fifty-five (55) gallons (or one (1) quart of liquid reactive acutely hazardous unwanted material or one (1) kilogram of solid reactive acutely hazardous unwanted material), the eligible academic entity is not required to remove all unwanted materials

from the laboratory within ten (10) calendar days of exceeding fifty-five (55) gallons (or one (1) quart of liquid reactive acutely hazardous unwanted material or one (1) kilogram of solid reactive acutely hazardous unwanted material), as required by section 262.208. Instead, the eligible academic entity must remove all unwanted materials from the laboratory within thirty (30) calendar days from the start of the laboratory clean-out; and

(2) For the purposes of on-site accumulation, an eligible academic entity is not required to count a hazardous waste that is an unused commercial chemical product (listed in R.61-79.261, subpart D or exhibiting one or more characteristics in R.61-79.261, subpart C) generated solely during the laboratory clean-out toward its hazardous waste ~~generator-statuscategory~~, pursuant to ~~261.5(e) and (d)R.61-79.262.13~~. An unwanted material that is generated prior to the beginning of the laboratory clean-out and is still in the laboratory at the time the laboratory clean-out commences must be counted toward hazardous waste ~~generator statuscategory~~, pursuant to ~~261.5(e) and (d)R.61-79.262.13~~, if it is determined to be hazardous waste; and

(3) For the purposes of off-site management, an eligible academic entity must count all its hazardous waste, regardless of whether the hazardous waste was counted toward ~~generator-statuscategory~~ under paragraph (a)(2) of this section, and if it generates more than 1 kg/month of acute hazardous waste or more than 100 kg/month of non-acute hazardous waste (i.e., the ~~conditionally exempt~~ every small quantity generator limits of ~~261.5 as defined in R.61-79.260.10~~), the hazardous waste is subject to all applicable hazardous waste regulations when it is transported off-site; and

**Revise 61-79.262.213(b)(2) to read:**

(2) The requirement to count all hazardous waste, including unused hazardous waste, generated during the laboratory clean-out toward its hazardous waste ~~generator-statuscategory~~, pursuant to ~~261.5(e) and (d)R.61-79.262.13~~.

**Revise 61-79.262.214(b)(5) to read:**

(5) Describe its intended best practices for making hazardous waste determinations, including specifying the duties of the individuals involved in the process (see the required standards at section 262.11(a) through (d) and R.61-79.262.209 through 262.212).

**Revise 61-79.262.216 to read:**

(a) Remains subject to the generator requirements of R.61-79.262.11 and 262.34(c)262.15 for large quantity generators and small quantity generators (if the hazardous waste is managed in a satellite accumulation area), and all other applicable generator requirements of R.61-79.262, with respect to that hazardous waste; or

(b) Remains subject to the conditional exemption of 261.5(b)R.61-79.262.14 for ~~conditionally exempt~~ every small quantity generators, with respect to that hazardous waste.

**Revise 61-79.262 to add Subpart L—Alternative Standards for Episodic Generation to r**

**SUBPART L: Alternative Standards for Episodic Generation**

**262.230 Applicability.**

This subpart is applicable to very small quantity generators and small quantity generators as defined in R.61-79.260.10.

### **262.231 Definitions for this subpart.**

**“Episodic event”** means an activity or activities, either planned or unplanned, that does not normally occur during generator operations, resulting in an increase in the generation of hazardous wastes that exceeds the calendar month quantity limits for the generator’s usual category.

**“Planned episodic event”** an episodic event that the generator planned and prepared for, including regular maintenance, tank cleanouts, short-term projects, and removal of excess chemical inventory.

**“Unplanned episodic event”** an episodic event that the generator did not plan or reasonably did not expect to occur, including production process upsets, product recalls, accidental spills, or “acts of nature,” such as tornado, hurricane, or flood.

### **262.232 Conditions for a generator managing hazardous waste from an episodic event**

(a) Very small quantity generator. A very small quantity generator may maintain its existing generator category for hazardous waste generated during an episodic event provided that the generator complies with the following conditions:

(1) The very small quantity generator is limited to one (1) episodic event per calendar year, unless a petition is granted under R.61-79.262.233;

(2) Notification. The very small quantity generator must notify the Department no later than thirty (30) calendar days prior to initiating a planned episodic event using EPA Form 8700-12. In the event of an unplanned episodic event, the generator must notify the Department within seventy-two (72) hours of the unplanned event via phone, email, or fax and subsequently submit EPA Form 8700-12. The generator shall include the start date and end date of the episodic event, the reason(s) for the event, types and estimated quantities of hazardous waste expected to be generated as a result of the episodic event, and shall identify a facility contact and emergency coordinator with 24-hour telephone access to discuss the notification submittal or respond to an emergency in compliance with R.61-79.262.16(b)(9)(i);

(3) EPA Identification Number. The very small quantity generator must have an EPA identification number or obtain an EPA identification number using EPA Form 8700-12;

(4) Accumulation. A very small quantity generator is prohibited from accumulating hazardous waste generated from an episodic event on drip pads and in containment buildings. When accumulating hazardous waste in containers and tanks the following conditions apply:

(i) Containers. A very small quantity generator accumulating in containers must mark or label its containers with the following:

(A) The words “Episodic Hazardous Waste”;

(B) An indication of the hazards of the contents (examples include, but are not limited to, the applicable hazardous waste characteristic(s) (i.e., ignitable, corrosive, reactive, toxic); hazard communication consistent with the Department of Transportation requirements at 49 CFR part 172 subpart E (labeling) or subpart F (placarding); a hazard statement or pictogram consistent with the Occupational

Safety and Health Administration Hazard Communication Standard at 29 CFR 1910.1200; or a chemical hazard label consistent with the National Fire Protection Association code 704); and

(C) The date upon which the episodic event began, clearly visible for inspection on each container.

(ii) Tanks. A very small quantity generator accumulating episodic hazardous waste in tanks must do the following:

(A) Mark or label the tank with the words “Episodic Hazardous Waste”;

(B) Mark or label its tanks with an indication of the hazards of the contents (examples include, but are not limited to, the applicable hazardous waste characteristic(s) (i.e., ignitable, corrosive, reactive, toxic); hazard communication consistent with the Department of Transportation requirements at 49 CFR part 172 subpart E (labeling) or subpart F (placarding); a hazard statement or pictogram consistent with the Occupational Safety and Health Administration Hazard Communication Standard at 29 CFR 1910.1200; or a chemical hazard label consistent with the National Fire Protection Association code 704);

(C) Use inventory logs, monitoring equipment or other records to identify the date upon which each episodic event begins; and

(D) Keep inventory logs or records with the above information on site and readily available for inspection.

(iii) Hazardous waste must be managed in a manner that minimizes the possibility of a fire, explosion, or release of hazardous waste or hazardous waste constituents to the air, soil, or water;

(A) Containers must be in good condition and compatible with the hazardous waste being accumulated therein. Containers must be kept closed except to add or remove waste; and

(B) Tanks must be in good condition and compatible with the hazardous waste accumulated therein. Tanks must have procedures in place to prevent the overflow (e.g., be equipped with a means to stop inflow with systems such as a waste feed cutoff system or bypass system to a standby tank when hazardous waste is continuously fed into the tank). Tanks must be inspected at least once each operating day to ensure all applicable discharge control equipment, such as waste feed cutoff systems, bypass systems, and drainage systems are in good working order and to ensure the tank is operated according to its design by reviewing the data gathered from monitoring equipment such as pressure and temperature gauges from the inspection.

(5) The very small quantity generator must comply with the hazardous waste manifest provisions of R.61-79.262 subpart B when it sends its episodic event hazardous waste off site to a designated facility, as defined in R.61-79.260.10.

(6) The very small quantity generator has up to sixty (60) calendar days from the start of the episodic event to manifest and send its hazardous waste generated from the episodic event to a designated facility, as defined in R.61-79.260.10.

(7) Very small quantity generators must maintain the following records for three (3) years from the end date of the episodic event:

(i) Beginning and end dates of the episodic event;



(ii) A description of the episodic event;

(iii) A description of the types and quantities of hazardous wastes generated during the event;

(iv) A description of how the hazardous waste was managed as well as the name of the RCRA-designated facility that received the hazardous waste;

(v) Name(s) of hazardous waste transporters; and

(vi) An approval letter from the Department if the generator petitioned to conduct one (1) additional episodic event per calendar year.

(b) Small quantity generators. A small quantity generator may maintain its existing generator category during an episodic event provided that the generator complies with the following conditions:

(1) The small quantity generator is limited to one (1) episodic event per calendar year unless a petition is granted under R.61-79.262.233;

(2) Notification. The small quantity generator must notify the Department no later than thirty (30) calendar days prior to initiating a planned episodic event using EPA Form 8700-12. In the event of an unplanned episodic event, the small quantity generator must notify the Department within seventy-two (72) hours of the unplanned event via phone, email, or fax, and subsequently submit EPA Form 8700-12. The small quantity generator shall include the start date and end date of the episodic event and the reason(s) for the event, types and estimated quantities of hazardous wastes expected to be generated as a result of the episodic event, and identify a facility contact and emergency coordinator with twenty-four (24)-hour telephone access to discuss the notification submittal or respond to emergency;

(3) EPA Identification Number. The small quantity generator must have an EPA identification number or obtain an EPA identification number using EPA Form 8700-12; and

(4) Accumulation by small quantity generators. A small quantity generator is prohibited from accumulating hazardous wastes generated from an episodic event waste on drip pads and in containment buildings. When accumulating hazardous waste generated from an episodic event in containers and tanks, the following conditions apply:

(i) Containers. A small quantity generator accumulating episodic hazardous waste in containers must meet the standards at R.61-79.262.16(b)(2) and must mark or label its containers with the following:

(A) The words "Episodic Hazardous Waste";

(B) An indication of the hazards of the contents (examples include, but are not limited to, the applicable hazardous waste characteristic(s) (i.e., ignitable, corrosive, reactive, toxic); hazard communication consistent with the Department of Transportation requirements at 49 CFR part 172 subpart E (labeling) or subpart F (placarding); a hazard statement or pictogram consistent with the Occupational Safety and Health Administration Hazard Communication Standard at 29 CFR 1910.1200; or a chemical hazard label consistent with the National Fire Protection Association code 704); and

(C) The date upon which the episodic event began, clearly visible for inspection on each container.

(ii) Tanks. A small quantity generator accumulating episodic hazardous waste in tanks must meet the standards at section 262.16(b)(3) and must do the following:

(A) Mark or label its tank with the words “Episodic Hazardous Waste”;

(B) Mark or label its tanks with an indication of the hazards of the contents (examples include, but are not limited to, the applicable hazardous waste characteristic(s) (i.e., ignitable, corrosive, reactive, toxic); hazard communication consistent with the Department of Transportation requirements at 49 CFR part 172 subpart E (labeling) or subpart F (placarding); a hazard statement or pictogram consistent with the Occupational Safety and Health Administration Hazard Communication Standard at 29 CFR 1910.1200; or a chemical hazard label consistent with the National Fire Protection Association code 704);

(C) Use inventory logs, monitoring equipment or other records to identify the date upon which each period of accumulation begins and ends; and

(D) Keep inventory logs or records with the above information on site and available for inspection.

(5) The small quantity generator must treat hazardous waste generated from an episodic event on site or manifest and ship such hazardous waste off site to a designated facility (as defined by R.61-79.260.10) within sixty (60) calendar days from the start of the episodic event.

(6) The small quantity generator must maintain the following records for three (3) years from the end date of the episodic event:

(i) Beginning and end dates of the episodic event;

(ii) A description of the episodic event;

(iii) A description of the types and quantities of hazardous wastes generated during the event;

(iv) A description of how the hazardous waste was managed as well as the name of the designated facility (as defined by R.61-79.260.10) that received the hazardous waste;

(v) Name(s) of hazardous waste transporters; and

(vi) An approval letter from the Department if the generator petitioned to conduct one (1) additional episodic event per calendar year.

### **262.233 Petition to manage one additional episodic event per calendar year.**

(a) A generator may petition the Department for a second episodic event in a calendar year without impacting its generator category under the following conditions:

(1) If a very small quantity generator or small quantity generator has already held a planned episodic event in a calendar year, the generator may petition the Department for an additional unplanned episodic event in that calendar year within seventy-two (72) hours of the unplanned event.

(2) If a very small quantity generator or small quantity generator has already held an unplanned episodic event in a calendar year, the generator may petition the Department for an additional planned episodic event in that calendar year.

(b) The petition must include the following:

(1) The reason(s) why an additional episodic event is needed and the nature of the episodic event;

(2) The estimated amount of hazardous waste to be managed from the event;

(3) How the hazardous waste is to be managed;

(4) The estimated length of time needed to complete management of the hazardous waste generated from the episodic event—not to exceed sixty (60) days; and

(5) Information regarding the previous episodic event managed by the generator, including the nature of the event, whether it was a planned or unplanned event, and how the generator complied with the conditions.

(c) The petition must be made to the Department in writing, either on paper or electronically.

(d) The generator must retain written approval in its records for three (3) years from the date the episodic event ended.

**Revise 61-79.262 to add Subpart M—Preparedness, Prevention, and Emergency Procedures for Large Quantity Generators to read:**

**SUBPART M: Preparedness, Prevention, and Emergency Procedures for Large Quantity**

**262.250 Applicability.**

The regulations of this subpart apply to those areas of a large quantity generator where hazardous waste is generated or accumulated on site.

**262.251 Maintenance and operation of facility.**

A large quantity generator must maintain and operate its facility to minimize the possibility of a fire, explosion, or any unplanned sudden or non-sudden release of hazardous waste or hazardous waste constituents to air, soil, or surface water which could threaten human health or the environment.

**262.252 Required equipment.**

All areas deemed applicable by R.61-79.262.250 must be equipped with the items in paragraphs (a) through (d) of this section (unless none of the hazards posed by waste handled at the facility could require a particular kind of equipment specified below or the actual hazardous waste generation or accumulation area does not lend itself for safety reasons to have a particular kind of equipment specified below). A large quantity generator may determine the most appropriate locations within its facility to locate equipment necessary to prepare for and respond to emergencies:

(a) An internal communications or alarm system capable of providing immediate emergency instruction (voice or signal) to facility personnel;

(b) A device, such as a telephone (immediately available at the scene of operations) or a hand-held two-way radio, capable of summoning emergency assistance from local police departments, fire departments, or state or local emergency response teams;

(c) Portable fire extinguishers, fire control equipment (including special extinguishing equipment, such as that using foam, inert gas, or dry chemicals), spill control equipment, and decontamination equipment; and

(d) Water at adequate volume and pressure to supply water hose streams, or foam producing equipment, or automatic sprinklers, or water spray systems.

### **262.253 Testing and maintenance of equipment.**

All communications or alarm systems, fire protection equipment, spill control equipment, and decontamination equipment, where required, must be tested and maintained as necessary to assure its proper operation in time of emergency.

### **262.254 Access to communications or alarm system.**

(a) Whenever hazardous waste is being poured, mixed, spread, or otherwise handled, all personnel involved in the operation must have immediate access (e.g., direct or unimpeded access) to an internal alarm or emergency communication device, either directly or through visual or voice contact with another employee, unless such a device is not required under R.61-79.262.252.

(b) In the event there is only one employee on the premises while the facility is operating, the employee must have immediate access (e.g., direct or unimpeded access) to a device, such as a telephone (immediately available at the scene of operation) or a hand-held two-way radio, capable of summoning external emergency assistance, unless such a device is not required under R.61-79.262.252.

### **262.255 Required aisle space.**

The large quantity generator must maintain aisle space to allow the unobstructed movement of personnel, fire protection equipment, spill control equipment, and decontamination equipment to any area of facility operation in an emergency, unless aisle space is not needed for any of these purposes.

### **262.256 Arrangements with local authorities.**

(a) The large quantity generator must attempt to make arrangements with the local police department, fire department, other emergency response teams, emergency response contractors, equipment suppliers, and local hospitals, taking into account the types and quantities of hazardous wastes handled at the facility. Arrangements may be made with the Local Emergency Planning Committee, if it is determined to be the appropriate organization with which to make arrangements.

(1) A large quantity generator attempting to make arrangements with its local fire department must determine the potential need for the services of the local police department, other emergency response teams, emergency response contractors, equipment suppliers and local hospitals.

(2) As part of this coordination, the large quantity generator shall attempt to make arrangements, as necessary, to familiarize the above organizations with the layout of the facility, the properties of the hazardous waste handled at the facility and associated hazards, places where personnel would normally be

working, entrances to roads inside the facility, and possible evacuation routes as well as the types of injuries or illnesses which could result from fires, explosions, or releases at the facility.

(3) Where more than one police or fire department might respond to an emergency, the large quantity generator shall attempt to make arrangements designating primary emergency authority to a specific fire or police department, and arrangements with any others to provide support to the primary emergency authority.

(b) The large quantity generator shall maintain records documenting the arrangements with the local fire department as well as any other organization necessary to respond to an emergency. This documentation must include documentation in the operating record that either confirms such arrangements actively exist or, in cases where no arrangements exist, confirms that attempts to make such arrangements were made.

(c) A facility possessing twenty-four (24)-hour response capabilities may seek a waiver from the authority having jurisdiction (AHJ) over the fire code within the facility's state or locality as far as needing to make arrangements with the local fire department as well as any other organization necessary to respond to an emergency, provided that the waiver is documented in the operating record.

### **262.260 Purpose and implementation of contingency plan.**

(a) A large quantity generator must have a contingency plan for the facility. The contingency plan must be designed to minimize hazards to human health or the environment from fires, explosions, or any unplanned sudden or non-sudden release of hazardous waste or hazardous waste constituents to air, soil, or surface water.

(b) The provisions of the plan must be carried out immediately whenever there is a fire, explosion, or release of hazardous waste or hazardous waste constituents which could threaten human health or the environment.

### **262.261 Content of contingency plan.**

(a) The contingency plan must describe the actions facility personnel must take to comply with R.61-79.262.260 and 262.265 in response to fires, explosions, or any unplanned sudden or non-sudden release of hazardous waste or hazardous waste constituents to air, soil, or surface water at the facility.

(b) If the generator has already prepared a Spill Prevention, Control, and Countermeasures (SPCC) Plan in accordance with 40 CFR part 112, or some other emergency or contingency plan, it need only amend that plan to incorporate hazardous waste management provisions that are sufficient to comply with the standards of this part. The generator may develop one contingency plan that meets all regulatory standards. The Department recommends that the plan be based on the National Response Team's Integrated Contingency Plan Guidance ("One Plan").

(c) The plan must describe arrangements agreed to with the local police department, fire department, other emergency response teams, emergency response contractors, equipment suppliers, local hospitals or, if applicable, the Local Emergency Planning Committee, pursuant to R.61-79.262.256.

(d) The plan must list names and emergency telephone numbers of all persons qualified to act as emergency coordinator (see R.61-79.262.264), and this list must be kept up to date. Where more than one person is listed, one must be named as primary emergency coordinator and others must be listed in the order in which they will assume responsibility as alternates. In situations where the generator facility has an emergency coordinator continuously on duty because it operates twenty-four (24) hours per day, every day

of the year, the plan may list the staffed position (e.g., operations manager, shift coordinator, shift operations supervisor) as well as an emergency telephone number that can be guaranteed to be answered at all times.

(e) The plan must include a list of all emergency equipment at the facility (such as fire extinguishing systems, spill control equipment, communications and alarm systems (internal and external), and decontamination equipment), where this equipment is required. This list must be kept up to date. In addition, the plan must include the location and a physical description of each item on the list, and a brief outline of its capabilities.

(f) The plan must include an evacuation plan for generator personnel where there is a possibility that evacuation could be necessary. This plan must describe signal(s) to be used to begin evacuation, evacuation routes, and alternate evacuation routes (in cases where the primary routes could be blocked by releases of hazardous waste or fires).

### **262.262 Copies of contingency plan.**

A copy of the contingency plan and all revisions to the plan must be maintained at the large quantity generator and—

(a) The large quantity generator must submit a copy of the contingency plan and all revisions to all local emergency responders (i.e., police departments, fire departments, hospitals, and state and local emergency response teams that may be called upon to provide emergency services). This document may also be submitted to the Local Emergency Planning Committee, as appropriate.

(b) A large quantity generator that first becomes subject to these provisions after May 30, 2017, or a large quantity generator that is otherwise amending its contingency plan must at that time submit a quick reference guide of the contingency plan to the local emergency responders identified at paragraph (a) of this section or, as appropriate, the Local Emergency Planning Committee. The quick reference guide must include the following elements:

(1) The types/names of hazardous wastes in layman's terms and the associated hazard associated with each hazardous waste present at any one time (e.g., toxic paint wastes, spent ignitable solvent, corrosive acid);

(2) The estimated maximum amount of each hazardous waste that may be present at any one time;

(3) The identification of any hazardous wastes where exposure would require unique or special treatment by medical or hospital staff;

(4) A map of the facility showing where hazardous wastes are generated, accumulated, and treated and routes for accessing these wastes;

(5) A street map of the facility in relation to surrounding businesses, schools, and residential areas to understand how best to get to the facility and also evacuate citizens and workers;

(6) The locations of water supply (e.g., fire hydrant and its flow rate);

(7) The identification of on-site notification systems (e.g., a fire alarm that rings off site, smoke alarms); and

(8) The name of the emergency coordinator(s) and twenty-four (24) hour, seven (7)-days-a-week emergency telephone number(s) or, in the case of a facility where an emergency coordinator is continuously on duty, the emergency telephone number for the emergency coordinator.

(c) Generators must update, if necessary, their quick reference guides, whenever the contingency plan is amended and submit these documents to the local emergency responders identified at paragraph (a) of this section or, as appropriate, the Local Emergency Planning Committee.

### **262.263 Amendment of contingency plan.**

The contingency plan must be reviewed, and immediately amended, if necessary, whenever:

(a) Applicable regulations are revised;

(b) The plan fails in an emergency;

(c) The generator facility changes—in its design, construction, operation, maintenance, or other circumstances—in a way that materially increases the potential for fires, explosions, or releases of hazardous waste or hazardous waste constituents, or changes the response necessary in an emergency;

(d) The list of emergency coordinators changes; or

(e) The list of emergency equipment changes.

### **262.264 Emergency coordinator.**

At all times, there must be at least one employee either on the generator's premises or on call (i.e., available to respond to an emergency by reaching the facility within a short period of time) with the responsibility for coordinating all emergency response measures and implementing the necessary emergency procedures outlined in R.61-79.262.265. Although responsibilities may vary depending on factors such as type and variety of hazardous waste(s) handled by the facility, as well as type and complexity of the facility, this emergency coordinator must be thoroughly familiar with all aspects of the generator's contingency plan, all operations and activities at the facility, the location and characteristics of hazardous waste handled, the location of all records within the facility, and the facility's layout. In addition, this person must have the authority to commit the resources needed to carry out the contingency plan.

### **262.265 Emergency procedures.**

(a) Whenever there is an imminent or actual emergency situation, the emergency coordinator (or his designee when the emergency coordinator is on call) must immediately:

(1) Activate internal facility alarms or communication systems, where applicable, to notify all facility personnel; and

(2) Notify appropriate state or local agencies with designated response roles if their help is needed.

(b) Whenever there is a release, fire, or explosion, the emergency coordinator must immediately identify the character, exact source, amount, and areal extent of any released materials. The emergency coordinator may do this by observation or review of the facility records or manifests and, if necessary, by chemical analysis.

(c) Concurrently, the emergency coordinator must assess possible hazards to human health or the environment that may result from the release, fire, or explosion. This assessment must consider both direct and indirect effects of the release, fire, or explosion (e.g., the effects of any toxic, irritating, or asphyxiating gases that are generated, or the effects of any hazardous surface water run-offs from water or chemical agents used to control fire and heat-induced explosions).

(d) If the emergency coordinator determines that the facility has had a release, fire, or explosion which could threaten human health, or the environment, outside the facility, the emergency coordinator must report the findings as follows:

(1) If the assessment indicates that evacuation of local areas may be advisable, the emergency coordinator must immediately notify appropriate local authorities. The emergency coordinator must be available to help appropriate officials decide whether local areas should be evacuated; and

(2) The emergency coordinator must immediately notify either the government official designated as the on-scene coordinator for that geographical area, or the National Response Center (using their 24-hour toll free number 800/424-8802). The report must include:

(i) Name and telephone number of reporter;

(ii) Name and address of the generator;

(iii) Time and type of incident (e.g., release, fire);

(iv) Name and quantity of material(s) involved, to the extent known;

(v) The extent of injuries, if any; and

(vi) The possible hazards to human health, or the environment, outside the facility.

(e) During an emergency, the emergency coordinator must take all reasonable measures necessary to ensure that fires, explosions, and releases do not occur, recur, or spread to other hazardous waste at the generator's facility. These measures must include, where applicable, stopping processes and operations, collecting and containing released hazardous waste, and removing or isolating containers.

(f) If the generator stops operations in response to a fire, explosion or release, the emergency coordinator must monitor for leaks, pressure buildup, gas generation, or ruptures in valves, pipes, or other equipment, wherever this is appropriate.

(g) Immediately after an emergency, the emergency coordinator must provide for treating, storing, or disposing of recovered waste, contaminated soil or surface water, or any other material that results from a release, fire, or explosion at the facility. Unless the generator can demonstrate, in accordance with section 261.3(c) or (d), that the recovered material is not a hazardous waste, then it is a newly generated hazardous waste that must be managed in accordance with all the applicable requirements and conditions for exemption in R.61-79.262, 263, and 265.

(h) The emergency coordinator must ensure that, in the affected area(s) of the facility:

(1) No hazardous waste that may be incompatible with the released material is treated, stored, or disposed of until cleanup procedures are completed; and



(2) All emergency equipment listed in the contingency plan is cleaned and fit for its intended use before operations are resumed.

(i) The generator must note in the operating record the time, date, and details of any incident that requires implementing the contingency plan. Within fifteen (15) days after the incident, the generator must submit a written report on the incident to the Department. The report must include:

(1) Name, address, and telephone number of the generator;

(2) Date, time, and type of incident (e.g., fire, explosion);

(3) Name and quantity of material(s) involved;

(4) The extent of injuries, if any;

(5) An assessment of actual or potential hazards to human health or the environment, where this is applicable; and

(6) Estimated quantity and disposition of recovered material that resulted from the incident.

**Revise 61-79.263.12 to add 263.12(a) to 263.12(b) to read:**

(a) A transporter who stores manifested shipments of hazardous waste in containers meeting the independent requirements of R.61-79.262.30 at a transfer facility for a period of ten (10) days or less is not subject to regulation under ~~R.61-79.270~~ R.61-79.264, ~~R.61-79.265~~, and ~~R.61-79.268~~, and 270 with respect to the storage of those wastes.

(b) When consolidating the contents of two or more containers with the same hazardous waste into a new container, or when combining and consolidating two different hazardous wastes that are compatible with each other, the transporter must mark its containers of one hundred nineteen (119) gallons or less with the following information:

(1) The words "Hazardous Waste" and

(2) The applicable EPA hazardous waste number(s) (EPA hazardous waste codes) in R.61-79.261 in subparts C and D, or in compliance with section 262.32(c).

**Revise 61-79.264.1(g)(1) to read:**

(1) The owner or operator of a facility permitted, licensed, or registered by the Department to manage municipal or industrial solid waste, if the only hazardous waste the facility treats, stores, or disposes of is excluded under ~~R.61-79.261.5~~261.14;

**Revise 61-79.264.1(g)(3) to read:**

(3) A generator accumulating waste onsite in compliance with ~~R.61-79.262.34~~262.14, 262.15, 262.16, or 262.17;

**Revise 61-79.264.15(b)(4) to remove the comment and to read:**

(4) The frequency of inspection may vary for the items on the schedule. However, the frequency should be based on the rate of deterioration of the equipment and the probability of an environmental or human health incident if the deterioration, malfunction, or any operator error goes undetected between inspections. Areas subject to spills, such as loading and unloading areas, must be inspected daily when in use. At a minimum, the inspection schedule must include the items and frequencies called for in R.61-79.264.174, 264.193, 264.195, 264.226, 264.254, 264.278, 264.303, 264.347, 264.602, 264.1033, 264.1052, 264.1053, 264.1058, and 264.1083 through 264.1089 where applicable. R.61-79.270 requires the inspection schedule to be submitted with part B of the permit application. The Department will evaluate the schedule along with the rest of the application to ensure that it adequately protects human health and the environment. As part of this review, the Department may modify or amend the schedule as may be necessary.

~~— [Comment: Part 270 of this chapter requires the inspection schedule to be submitted with Part B of the permit application. The Department will evaluate the schedule along with the rest of the application to ensure that it adequately protects human health and the environment. As part of this review, the Department may modify or amend the schedule as may be necessary. (revised 12/92)]~~

**Revise 61-79.264.71(c) to remove the comment and to read:**

(c) Whenever a shipment of hazardous waste is initiated from a facility, the owner or operator of that facility must comply with the requirements of R.61-79.262. The provisions of sections 262.15, 262.16, and 262.17 are applicable to the on-site accumulation of hazardous wastes by generators. Therefore, the provisions of sections 262.15, 262.16, and 262.17 only apply to owners or operators who are shipping hazardous waste which they generated at that facility or operating as a large quantity generator consolidating hazardous waste from very small quantity generators under section 262.17(f).

~~— [Comment: The provisions of R.61-79.262.34 are applicable to the onsite accumulation of hazardous wastes by generators. Therefore, the provisions of 262.34 only apply to owners or operators who are shipping hazardous waste which they generated at that facility.]~~

**Revise 61-79.264.174 to remove comment and to read:**

At least weekly, the owner or operator must inspect areas where containers are stored. The owner or operator must look for leaking containers and for deterioration of containers and the containment system caused by corrosion or other factors. See sections 264.15(c) and 264.171 for remedial action required if deterioration or leaks are detected.

~~— [Comment: See 264.15(c) and 264.171 for remedial action required if deterioration or leaks are detected.]~~

**Revise 61-79.264.1030(b)(2) to read:**

(2) A unit (including a hazardous waste recycling unit) that is not exempt from permitting under the provisions of ~~262.34(a)~~R.61-79.262.17 (i.e., a hazardous waste recycling unit that is not a ninety (90)-day tank or container) and that is located at a hazardous waste management facility otherwise subject to the permitting requirements of 270, or

**Revise 61-79.264.1050(b)(3) to read:**

(3) A unit that is exempt from permitting under the provisions of ~~262.34(a)~~R.61-79.262.17 (i.e., a "90-day" tank or container) and is not a recycling unit under the provisions of 261.6.

**Revise 61-79.265.1(c)(5) to read:**

(5) The owner or operator of a facility permitted, licensed, or registered by a State to manage municipal or industrial solid waste, if the only hazardous waste the facility treats, stores, or disposes of is excluded from regulation under this part by ~~261.5 of this chapter~~ R.61-79.262.14; (revised 12/92)

**Revise 61-79.265.1(c)(7) to read:**

(7) A generator accumulating waste onsite in compliance with ~~262.34 of this chapter~~ applicable conditions for exemption in R.61-79.262.14 through 262.17, and R.61-79.262 subparts K and L, except to the extent the requirements ~~are included in 262.34 of this R.61-79.262~~ are included in those sections and subparts;

**Revise 61-79.265.71(c) to remove comment and to read:**

(c) Whenever a shipment of hazardous waste is initiated from a facility, the owner or operator of that facility must comply with the requirements of part 262. The provisions of R.61-79.262.15, 262.16, and 262.17 are applicable to the on-site accumulation of hazardous wastes by generators. Therefore, the provisions of R.61-79.262.15, 262.16, and 262.17 only apply to owners or operators who are shipping hazardous waste which they generated at that facility or operating as a large quantity generator consolidating hazardous waste from very small quantity generators under section 262.17(f).

—[Comment: The provisions of 262.34 are applicable to the onsite accumulation of hazardous wastes by generators. Therefore, the provisions of section 262.34 only apply to owners or operators who are shipping hazardous waste which they generated at that facility.]

**Revise 61-79.265.174 to remove comment and to read:**

At least weekly, the owner or operator must inspect areas where containers are stored. The owner or operator must look for leaking containers and for deterioration of containers ~~and the containment system~~ caused by corrosion or other factors. See R.61-79.265.171 for remedial action required if deterioration or leaks are detected.

—[Comment: See 265.171 for remedial action required if deterioration or leaks are detected.]

**Revise 61-79.265.201 to remove and reserve it:**

**~~265.201 Special requirements for generators of between 100 and 1,000 kg/mo t hazardous waste in tanks.~~**

—(a) ~~The requirements of this section apply to small quantity generators of more than 100 kg but less than 1,000 kg of hazardous waste in a calendar month, that accumulate hazardous waste in tanks for less than 180 days (or 270 days if the generator must ship the waste greater than 200 miles), and do not accumulate over 6,000 kg onsite at any time.~~

—(b) ~~Generators of between 100 and 1,000 kg/mo hazardous waste must comply with the following general operating requirements:~~

—(1) ~~Treatment or storage of hazardous waste in tanks must comply with 265.17(b).~~

—(2) ~~Hazardous wastes or treatment reagents must not be placed in a tank if they could cause the tank or its inner liner to rupture, leak, corrode, or otherwise fail before the end of its intended life.~~

~~—(3) Uncovered tanks must be operated to ensure at least 60 centimeters (2 feet) of freeboard, unless the tank is equipped with a containment structure (e.g., dike or trench), a drainage control system, or a diversion structure (e.g., standby tank) with a capacity that equals or exceeds the volume of the top 60 centimeters (2 feet) of the tank.~~

~~—(4) Where hazardous waste is continuously fed into a tank, the tank must be equipped with a means to stop this inflow (e.g., waste feed cutoff system or by pass system to a stand by tank). [NOTE: These systems are intended to be used in the event of a leak or overflow from the tank due to a system failure (e.g., a malfunction in the treatment process, a crack in the tank, etc.).]~~

~~—(e) Except as noted in paragraph (d) of this section, generators who accumulate between 100 and 1,000 kg/mo of hazardous waste in tanks must inspect, where present:~~

~~—(1) Discharge control equipment (e.g., waste feed cutoff systems, by pass systems, and drainage systems) at least once each operating day, to ensure that it is in good working order;~~

~~—(2) Data gathered from monitoring equipment (e.g., pressure and temperature gauges) at least once each operating day to ensure that the tank is being operated according to its design;~~

~~—(3) The level of waste in the tank at least once each operating day to ensure compliance with 265.201(b)(3);~~

~~—(4) The construction materials of the tank at least weekly to detect corrosion or leaking of fixtures or seams; and~~

~~—(5) The construction materials of, and the area immediately surrounding, discharge confinement structures (e.g., dikes) at least weekly to detect erosion or obvious signs of leakage (e.g., wet spots or dead vegetation). [NOTE: As required by 265.15(e) the owner or operator must remedy any deterioration or malfunction he finds.]~~

~~—(d) Generators who accumulate between 100 and 1,000 kg/mo of hazardous waste in tanks or tank systems that have full secondary containment and that either use leak detection equipment to alert facility personnel to leaks, or implement established workplace practices to ensure leaks are promptly identified, must inspect at least weekly, where applicable, the areas identified in paragraphs (e)(1) through (5) of this section. Use of the alternate inspection schedule must be documented in the facility's operating record. This documentation must include a description of the established workplace practices at the facility.~~

~~—(e) [Reserved]~~

~~—(f) Generators of between 100 and 1,000 kg/mo accumulating hazardous waste in tanks must, upon closure of the facility, remove all hazardous waste from tanks, discharge control equipment, and discharge confinement structures. [NOTE: At closure, as throughout the operating period, unless the owner or operator can demonstrate, in accordance with 261.3(e) of (d) of this chapter, that any solid waste removed from his tank is not a hazardous waste, the owner or operator becomes a generator of hazardous waste and must manage it in accordance with all applicable requirements of Parts 262, 263, and 265 of this chapter.]~~

~~—(g) Generators of between 100 and 1,000 kg/mo must comply with the following special requirements for ignitable or reactive waste:~~

~~—(1) Ignitable or reactive waste must not be placed in a tank, unless:~~

- ~~—— (i) The waste is treated, rendered, or mixed before or immediately after placement in a tank so that~~
- ~~—— (A) the resulting waste, mixture, or dissolution of material no longer meets the definition of ignitable or reactive waste under 261.21 or 261.23 of this Chapter, and~~
- ~~—— (B) 265.17(b) is complied with; or~~
- ~~—— (ii) The waste is stored or treated in such a way that it is protected from any material or conditions that may cause the waste to ignite or react; or~~
- ~~—— (iii) The tank is used solely for emergencies.~~
- ~~—— (2) The owner or operator of a facility which treats or stores ignitable or reactive waste in covered tanks must comply with the buffer zone requirements for tanks contained in Tables 2-1 through 2-6 of the national Fire Protection Association's "Flammable and Combustible Liquids Code," (1977 or 1981) (incorporated by reference, see 260.11).~~
- ~~—— (h) Generators of between 100 and 1000 kg/mo must comply with the following special requirements for incompatible wastes;~~
- ~~—— (1) Incompatible wastes, or incompatible wastes and materials, (see Appendix V for examples) must not be placed in the same tank, unless 265.17(b) is complied with.~~
- ~~—— (2) Hazardous waste must not be placed in an unwashed tank which previously held an incompatible waste or material, unless 265.17(b) is complied with. [Reserved]~~

**Revise 61-79.265.1030(b)(2) and (b)(3) to read:**

- (2) A unit (including a hazardous waste recycling unit) that is not exempt from permitting under the provisions of ~~262.34(a)~~R.61-79.262.17 (i.e., a hazardous waste recycling unit that is not a 90-day tank or container) and that is located at a hazardous waste management facility otherwise subject to the permitting requirements of part 270, or
- (3) A unit that is exempt from permitting under the provisions of ~~262.34(a)~~R.61-79.262.17 (i.e., a "90-day" tank or container) and is not a recycling unit under the requirements of 261.6.

**Revise 61-79.265.1050(b)(2) and (b)(3) to read:**

- (2) A unit (including a hazardous waste recycling unit) that is not exempt from permitting under the provisions of ~~262.34(a)~~R.61-79.262.17 (i.e., a hazardous waste recycling unit that is not a ninety (90)-day tank or container) and that is located at a hazardous waste management facility otherwise subject to the permitting requirements of part 270, or
- (3) A unit that is exempt from permitting under the provisions of ~~262.34(a)~~R.61-79.262.17 (i.e., a "ninety (90)-day" tank or container) and is not a recycling unit under the provisions of 261.6. ~~(9/98)~~

**Revise 61-79.266.255(a) to read:**

- (a) When your LLMW has met the requirements of your NRC or NRC Agreement State license for decay-in-storage and can be disposed of as non-radioactive waste, then the conditional exemption for storage no

longer applies. On that date your waste is subject to hazardous waste regulation under the relevant sections of parts 260 through 271, and the time period for accumulation of a hazardous waste as specified in ~~262.34~~R.61-79.262.16 or 262.17 begins.

**Revise 61-79.268.1(e)(1) to read:**

(1) Wastes generated by very small quantity generators of less than 100 kg of non-acute hazardous—waste or less than 1 kg of acute hazardous waste per month, as defined in ~~261.5~~R.61-79.260.10;

**Revise 61-79.268.7(a)(5) to read:**

(5) If a generator is managing and treating prohibited waste or contaminated soil in tanks, containers, or containment buildings regulated under ~~262.34~~R.61-79.262.15, 262.16, and 262.17 to meet applicable LDR treatment standards found at 268.40, the generator must develop and follow a written waste analysis plan which describes the procedures they will carry out to comply with the treatment standards. (Generators treating hazardous debris under the alternative treatment standards of Table 1, 268.45, however, are not subject to these waste analysis requirements.) The plan must be kept on site in the generator's records, and the following requirements must be met: ~~(12/92, 12/93, 9/98)~~

**Revise 61-79.268.50(a)(1) to read:**

(1) A generator stores such wastes in tanks, containers, or containment buildings onsite solely for the purpose of the accumulation of such quantities of hazardous waste as necessary to facilitate proper recovery, treatment, or disposal and the generator complies with the requirements in ~~R.61-79.262.34~~R.61-79.262.16 and 262.17 and ~~parts R.61-79.264 and 265 of this chapter.~~

**Revise 61-79.268.50(a)(2) to add 268.50(a)(2)(i)(A) to 268.50(a)(2)(i)(D) to read:**

(i) Each container is clearly marked to identify its contents ~~and the date each period of accumulation begins;~~with:

(A) The words “Hazardous Waste”;

(B) The applicable EPA hazardous waste number(s) (EPA hazardous waste codes) in R.61-79.261 subparts C and D; or use a nationally recognized electronic system, such as bar coding, to identify the EPA hazardous waste number(s);

(C) An indication of the hazards of the contents (examples include, but are not limited to, the applicable hazardous waste characteristics(s) (i.e., ignitable, corrosive, reactive, toxic); hazard communication consistent with the Department of Transportation requirements at 49 CFR part 172 subpart E (labeling) or subpart F (placarding); a hazard statement or pictogram consistent with the Occupational Safety and Health Administration Hazard Communication Standard at 29 CFR 1910.1200; or a chemical hazard label consistent with the National Fire Protection Association code 704); and

(D) The date each period of accumulation begins.

**Revise 61-79.270.1(a)(3) to read:**

(3) ~~Deleted 12/93~~Technical regulations. The RCRA permit program has separate additional regulations that contain technical requirements. These separate regulations are used by permit issuing authorities to

determine what requirements must be placed in permits if they are issued. These separate regulations are located in R.61-79.264, 266, 267, and 268.

**Revise 61-79.270.1(c)(2) to read:**

(2) Specific exclusions and exemptions. The following persons are among those who are not required to obtain a RCRA permit under these regulations:

**Revise 61-79.270.1(c)(2)(i) to read:**

(i) Generators who accumulate hazardous waste onsite ~~for less than the time periods in compliance with all of the conditions for exemption provided in R.61-79.262.3414, 262.15, 262.16, and 262.17.~~

**Revise 61-79.270.1(c)(2)(iii) to read:**

(iii) Persons who own or operate facilities solely for the treatment, storage or disposal of hazardous waste excluded from regulations under this Part by R.61-79.261.4 or ~~261.5262.14~~ (very small quantity generator exemption).

**Revise 61-79.270.42(I) to reserve:**

(I) ~~[removed by State Register Volume No. 36, Issue No. 3, eff March 23, 2012]~~[Reserved]

**Revise 61-79.270.42 Appendix I to 270.42—Classification of Permit Modification to reserve:**

O. Burden Reduction	
1. Approval of reduced inspection frequency for Performance Track member facilities for: <del>[Reserved]</del>	
a. Tanks systems pursuant to § 264.195	+1
b. Containers pursuant to § 264.174	+1
c. Containment buildings pursuant to § 264.1101(e)(4)	+1
d. Areas subject to spills pursuant to § 264.15(b)(4)	+1
2. Development of one contingency plan based on Integrated Contingency Plan Guidance pursuant to section 264.52(b)	+
3. Changes to recordkeeping and reporting requirements pursuant to: sections 264.56(i), 264.343(a)(2), 264.1061(b)(1),(d), 264.1062(a)(2), 264.196(f), 264.100(g), and 264.113(e)(5)	+
4. Changes to inspection frequency for tank systems pursuant to section 264.195(b)	+
5. Changes to detection and compliance monitoring program pursuant to sections 264.98(d), (g)(2), and (g)(3), 264.99(f), and (g)	+

**Revise 61-79.273.8 section heading to read:**

**273.8 Applicability—household and conditionally exempt very small quantity generator**

**Revise 61-79.273.8(a)(2) to read:**

(2) ~~Conditionally exempt~~ Very small quantity generator wastes that are exempt under ~~261.5R.61-79.262.14 of this chapter~~ and are also of the same type as the universal wastes defined at 273.9.

**Revise 61-79.273.81(b) to read:**

(b) The waste or category of waste is not exclusive to a specific industry or group of industries, is commonly generated by a wide variety of types of establishments (including, for example, households, retail and commercial businesses, office complexes, ~~conditionally exempt~~ very small quantity generators, small businesses, government organizations, as well as large industrial facilities);



## **ATTACHMENT C**

### **DEPARTMENT OF HEALTH AND ENVIRONMENTAL CONTROL CHAPTER 61**

Statutory Authority: 1976 Code Section 44-56-30

#### **Notice of Drafting:**

The Department of Health and Environmental Control (“Department”) proposes amending Regulation 61-79, Hazardous Waste Management Regulations. Interested persons may submit comments in writing to David Scaturro, Director of the Division of Waste Management, Bureau of Land and Waste Management, 2600 Bull Street, Columbia, S.C. 29201 or via email at [scaturdm@dhec.sc.gov](mailto:scaturdm@dhec.sc.gov). To be considered, comments must be received no later than 5:00 p.m. on May 28, 2018, the close of the draft comment period.

#### **Synopsis:**

The Department proposes amending Regulation 61-79 to adopt a final rule published in the Federal Register by the United States Environmental Protection Agency (“EPA”). The Department’s adoption of the entirety of the rule is not required by federal law. The final rule is summarized below.

The Department proposes adopting the “Hazardous Waste Generator Improvements Rule,” published on November 28, 2016, at 81 FR 85732-85829. Adopting the rule would reorganize the hazardous waste generator regulations to improve their usability by the regulated community, provide a better understanding of how the Resource Conservation and Recovery Act hazardous waste generator regulatory program works, address gaps in existing regulations to strengthen environmental protections, provide greater flexibility for hazardous waste generators to manage their hazardous waste in a cost-effective and protective manner, and make technical corrections to address inadvertent errors and remove obsolete references to programs that no longer exist.

The Department may also include stylistic changes, such as corrections for clarity and readability, grammar, punctuation, definitions, references, codification, and overall improvement of the text of the regulation.

While the majority of the rule is equivalent to current state regulations and optional for state adoption, several provisions are more stringent and must be adopted by the Department to maintain federal program authorization. However, due to interrelated nature of the equivalent provisions and the more stringent provisions, the Department proposes adopting the rule in a single drafting that will undergo General Assembly review.

(x) ACTION/DECISION  
( ) INFORMATION

Date: October 11, 2018

To: S.C. Board of Health and Environmental Control

From: Bureau of Land and Waste Management

**Re: Notice of Proposed Regulation for Amending Regulation 61-79, Hazardous Waste Regulations.**

## I. Introduction

The Bureau of Land and Waste Management (“Bureau”) proposes the attached Notice of Proposed Regulation amending R.61-79, *Hazardous Waste Management Regulations* promulgated in the October 26, 2018 *South Carolina State Register*. Legal authority resides in the South Carolina Hazardous Waste Management Act, S.C. Code Ann. Section 44-56-30, which authorizes the Department of Health and Environmental Control (“Department”) to promulgate hazardous waste management regulations, procedures, or standards as may be necessary to protect human health and the environment. The Administrative Procedures Act, S.C. Code Ann. Section 1-23-120(H)(1) exempts this amendment from General Assembly review, as the Department promulgates this amendment for compliance with federal law.

## II. Facts

1. The Department of Health and Environmental Control (Department) proposes amending R.61-79, *Hazardous Waste Management Regulations*, the Imports and Exports of Hazardous Waste Rule published November 28, 2016, at 81 FR 85696-85729 and published on November 28, 2016 at 81 FR 85696-85729 and on August 29, 2017 at 82 FR 41015-41016 in the Federal Register by the United States Environmental Protection Agency (“EPA”). The Imports and Exports of Hazardous Waste Rule amends existing requirements regarding the import and export of hazardous wastes from and into the United States. The Department proposes adopting the rule to maintain compliance with federal law and provide greater protection to human health and the environment by making existing import- and export-related requirements more consistent with the current import-export requirements for shipments between members of the Organization for Economic Cooperation and Development, enabling electronic submittal to the EPA of all import- and export-related documents (e.g., export notices, export annual reports), and enabling electronic validation of consent in the Automated Export System for export shipments subject to Resource Conservation and Recovery Act (“RCRA”) export consent requirements prior to exit.
2. The Department had a Notice of Drafting published in the April 27, 2018 *State Register*. The Department received no public comments by May 28, 2018, the close of the public comment period.
3. Appropriate Department staff conducted an internal review of the proposed amendments on August 7, 2018.
4. The Department conducted outreach meetings with the South Carolina Chamber of Commerce Environmental Technical Committee. The Department also published a notice on the Regulation Development Update website and provided notice to interested parties via email.

### III. Request for Approval

The Bureau respectfully requests the Board to grant approval of the attached Notice of Proposed Regulation for publication in the October 26, 2018 *State Register*.

  
Henry Porter, Chief  
Bureau of Land and Waste Management

  
Myra Beece, Director  
Environmental Affairs

**Attachments:**

- A. Notice of Proposed Regulation
- B. Notice of Drafting published in the April 27, 2018, *State Register*

## ATTACHMENT A

### STATE REGISTER NOTICE OF PROPOSED REGULATION FOR REGULATION 61-79, *Hazardous Waste Management Regulations*

October 11, 2018

Document No. \_\_\_\_\_

#### DEPARTMENT OF HEALTH AND ENVIRONMENTAL CONTROL

CHAPTER 61

Statutory Authority: 1976 Code Section 44-56-30

61-79. Hazardous Waste Management Regulations.

#### Preamble:

The Department of Health and Environmental Control (Department) proposes amending R.61-79, Hazardous Waste Management Regulations, to adopt the “Imports and Exports of Hazardous Waste Rule” published on November 28, 2016 at 81 FR 85696-85729 and on August 29, 2017 at 82 FR 41015-41016 by the United States Environmental Protection Agency (“EPA”). The proposed amendment will support the Department’s goal of promoting and protecting the health of the public and the environment in a more efficient and effective manner. This amendment will make existing import- and export-related requirements more consistent with the current import-export requirements for shipments between members of the Organization for Economic Cooperation and Development, enable electronic submittal to the EPA of all import and export-related documents (e.g., export notices, export annual reports), and enable electronic validation of consent in the Automated Export System (“AES”) for export shipments subject to the Resource Conservation and Recovery Act (“RCRA”) export consent requirements prior to exit. Adoption of this rule is required to comply with federal law and will bring R.61-79 into conformity with the federal regulation. General Assembly review is not required.

The Department had a Notice of Drafting published in the April 27, 2018, South Carolina State Register.

#### Section-by-Section Discussion of Proposed Amendment:

260.10 Definitions. Add, in alphabetical order, the following new definitions: “AES filing compliance date,” “Electronic import-export reporting compliance date,” and “Recognized trader.”

261.4(d)(1). Revise item to insert “and (4)” after “paragraph (d)(2).”

261.4(d)(4). Add new item (4) to adopt language that describes how, in order to qualify for the exemption in 261.4(d)(1)(i) and (ii), the mass of a sample that will be exported to a foreign laboratory or that will be imported to a U.S. laboratory from a foreign source must additionally not exceed twenty-five (25) kilograms.

261.4(e)(1). Revise item to read, “Except as provided in paragraph (e)(2) and (4) of this section, persons who generate or collect samples for the purpose of conducting treatability studies as defined in R.61-79.260.10, are not subject to any requirement of R.61-79.261 through 263 or to the notification requirements of SC Hazardous Waste Management Act 44-56-120 and Section 3010 of RCRA, nor are such samples included in the quantity determinations of R.61-79.262.13 when:.”

261.4(e)(4). Add new item (4) to adopt language that describes how, in order to qualify for the exemption in 261.4(e)(1)(i), the mass of a sample that will be exported to a foreign laboratory or testing facility, or that will be imported to a U.S. laboratory or testing facility from a foreign source must additionally not exceed twenty-five (25) kilograms.

261.6(a)(3)(i). Revise item to replace “, unless provided otherwise in an international agreement as specified in 262.58:” with “exports and imports of such recyclable materials must comply with the requirements of R.61-79.262 subpart H.”

261.6(a)(5). Revise item to read, “Hazardous waste that is exported or imported for purpose of recovery is subject to the requirements of R.61-79.262 subpart H.”

261.39(a)(5)(ii). Revise item to read, “Notifications must be submitted electronically using EPA’s Waste Import Export Tracking System (WIETS), or its successor system.”

261.39(a)(5)(v). Revise item to read, “The export of CRTs is prohibited unless all of the following occur:”

261.39(a)(5)(v)(A). Add new item (5)(v)(A) to adopt language that describes how the receiving country must consent to the intended export.

261.39(a)(5)(v)(B). Add new item (5)(v)(B) to adopt language that introduces the requirements of the exporter or a U.S. authorized agent for the export of CRTs.

261.39(a)(5)(v)(B)(1). Add new item (v)(B) (1) to adopt language that describes how the exporter must submit Electronic Export Information (EEI) for each shipment to the Automated Export System (AES) or its successor system, under the International Trade Data System (ITDS) platform, in accordance with 15 CFR 30.4(b).

261.39(a)(5)(v)(B)(2). Add new item (v)(B) (2) and items (v)(B)(2)(i) to (v)(B)(2)(vi) to adopt language that describes how the exporter or U.S. authorized agent must include the following specific items in the EEI, along with the other information required under 15 CFR 30.6: EPA license code; commodity classification code; EPA consent number; country of ultimate destination; date of export; quantity of waste in the shipment; and EPA net quantity reported in kilogram.

261.39(a)(5)(vi). Revise first sentence to read, “When the conditions specified on the original notification change, the exporter must provide EPA with a written renotification of the change using the allowable methods listed in paragraph (a)(5)(ii) of this section, except for changes to the telephone number in paragraph (a)(5)(i)(A) of this section and decreases in the quantity indicated pursuant to paragraph (a)(5)(i)(C) of this section.” Revise the second sentence to replace “(a)(5)(i)” with “(H).”

261.39(a)(5)(ix). Revise item to add text to specify recordkeeping requirements.

261.39(a)(5)(xi). Revise item to remove the first sentence and adopt new language that describes annual report requirements.

262.10(d). Revise subsection to read, “Any person who exports or imports hazardous wastes must comply with R.61-79.262.18 and R.61-79.262 subpart H.”

262.41(c). Revise last sentence to read, “A separate annual report requirement is set forth at section 262.83(g) for hazardous waste exporters.”

262 Subpart E. Remove and reserve subpart.

262 Subpart F. Remove and reserve subpart.

262 Subpart H. Revise section title to read, “Transboundary Movements of Hazardous Waste for Recovery and Disposal.”

262.80(a). Revise subsection to read, “The requirements of this subpart apply to transboundary movements of hazardous wastes.”

262.80(b). Revise subsection to read, “Any person (including exporter, importer, disposal facility operator, or recovery facility operator) who mixes two or more wastes (including hazardous and non-hazardous wastes) or otherwise subjects two or more wastes (including hazardous and non-hazardous wastes) to physical or chemical transformation operations, and thereby creates a new hazardous waste, becomes a generator and assumes all subsequent generator duties under RCRA and the SC Hazardous Waste Management Act and any exporter duties, if applicable, under this subpart.”

262.81 Definitions. Revise section to clarify and revise the following existing definitions: “Competent authority,” “Countries concerned,” “Country of export,” “Country of import,” “Country of transit,” “Exporter,” “Importer,” “OECD area,” “Recovery operations,” and “Transboundary movement.” Add, in alphabetical order, the following definitions: “Disposal operations,” “EPA Acknowledgment of Consent,” “Export,” “Foreign exporter,” “Foreign importer,” “Foreign receiving facility,” “Import,” “OECD Member country,” and “Receiving facility.” Remove the definitions for: “Recognized trader” and “Recovery facility.”

262.82(a). Revise first sentence to replace “by the national procedures of the United States, as defined in 262.80(a)” with “whether the waste is or is not hazardous waste.” Revise the second sentence to replace “262.89(d)” with “in R.61-79.260.11.”

262.82(a)(1). Revise item to describe green list wastes that are subject to the requirements of this subpart.

262.82(a)(2). Revise item to describe amber list wastes that are subject to the requirements of this subpart.

262.82(a)(3). Revise item to describe mixtures of wastes that are subject to the requirements of this subpart.

262.82(a)(4)(i). Revise item to read, “If such wastes are hazardous wastes, such wastes are subject to the requirements of this subpart.”

262.82(a)(4)(ii). Revise item to read, “If such wastes are not hazardous wastes, such wastes are not subject to the requirements of this subpart.”

262.82(b)(1). Revise item to read, “The hazardous waste must be destined for recovery or disposal operations at a facility that, under applicable domestic law, is operating or is authorized to operate in the country of import;.”

262.82(b)(2). Revise item to remove the phrase “and the transboundary movement must be in compliance with applicable international transport agreements;.” Add note to paragraph (b)(2) to adopt language that describes how these international agreements include, but are not limited to, the Chicago Convention (1994), ADR (1957), ADN (1970), MARPOL Convention (1973/1978), SOLAS Convention (1974), IMDG Code (1985), COTIF (1985), and RID (1985).

262.82(b)(3). Revise item to read, “Any transit of hazardous waste through one or more countries must be conducted in compliance with all applicable international and national laws and regulations.”

262.82(c). Revise subsection to describe the duty to return wastes subject to the Amber control procedures during transit through the United States.

262.82(d). Revise subsection to read, “Laboratory analysis exemption. Export or import of a hazardous waste sample is exempt from the requirements of this subpart if the sample is destined for laboratory analysis to assess its physical or chemical characteristics, or to determine its suitability for recovery or disposal operations, does not exceed twenty-five (25) kilograms in quantity, is appropriately packaged and labeled, and complies with the conditions of R.61-79.261.4(d) or (e).”

262.82(e). Revise subsection to read, “EPA Address for submittals by postal mail or hand delivery. Submittals required in this subpart to be made by postal mail or hand delivery should be sent to the following addresses:.”

262.82(e)(1). Revise item to read, “For postal mail delivery, the Office of Land and Emergency Management, Office of Resource Conservation and Recovery, Materials Recovery and Waste Management Division, International Branch (Mail Code 2255A), Environmental Protection Agency, 1200 Pennsylvania Avenue NW, Washington, DC 20460.”

262.82(e)(2). Revise item to read, “For hand delivery, the Office of Land and Emergency Management, Office of Resource Conservation and Recovery, Materials Recovery and Waste Management Division, International Branch, Environmental Protection Agency, William Jefferson Clinton South Bldg., Room 6144, 1200 Pennsylvania Ave., NW., Washington, DC 20004.”

262.83. Revise title to read, “Exports of hazardous waste.”

262.83(a). Revise subsection to read, “General export requirements. Except as provided in paragraphs (a)(5) and (6) of this section, exporters that have received an AOC from EPA before December 31, 2016 are subject to that approval and the requirements listed in the AOC that existed at the time of that approval until such time the approval period expires. All other exports of hazardous waste are prohibited unless:.” Add new items (1) through (6) to adopt language that describes the general export requirements.

262.83(b). Revise heading to read, “Notifications—.”

262.83(b)(1). Revise item to describe and clarify general notifications of hazardous waste shipments and state what information is required in the notifications.

262.83(b)(2). Revise item to clarify export requirements to pre-consented recovery facilities in OECD Member countries. Remove items (2)(i) and (ii).

262.83(b)(3). Add new item (3) to adopt language that describes how notifications must list interim recycling operations or interim disposal operations.

262.83(b)(4). Add new item (4) to adopt language that describes how when the exporter wishes to change any of the information specified on the original notification (including increasing the estimate of the total quantity of hazardous waste specified in the original notification or adding transporters), the exporter must submit a renotification of the changes to EPA using the allowable methods in 262.83(b)(1) of this section. Any shipment using the requested changes cannot take place until the countries of import and transit consent

to the changes and the exporter receives an EPA AOC letter documenting the countries' consents to the changes.

262.83(b)(5). Add new item (5) to adopt language that describes EPA coordination for countries of import and recovery or disposal operations not covered under the international agreement.

262.83(b)(6). Add new item (6) to adopt language that describes where the countries of import and transit consent to the proposed transboundary movement(s) of the hazardous waste(s), EPA will forward an EPA AOC letter to the exporter documenting the countries' consents. Where any of the countries of import and transit objects to the proposed transboundary movement(s) of the hazardous waste or withdraws a prior consent, EPA will notify the exporter.

262.83(b)(7). Add new item (7) to adopt language that describes how U.S. exporters must comply with the export requirements in section 262.83.

262.83(b)(8). Add new item (8) to adopt language that describes how upon request by EPA, the exporter must furnish to EPA any additional information which the country of import requests in order to respond to a notification.

262.83(c). Revise subsection to read, "RCRA manifest instructions for export shipments. The exporter must comply with the manifest requirements of sections 262.20 through 262.23 except that:."

262.83(c)(1). Add new item (1) to adopt language that describes how the exporter must enter the name and site address of the foreign receiving facility in lieu of the name, site address, and EPA number of the designated permitted facility.

262.83(c)(2). Add new item (2) to adopt language that describes how the exporter must check the export box and enter the U.S. port of exit from the United States.

262.83(c)(3). Add new item (3) to adopt language that describes how the exporter must list the consent number from the AOC for each hazardous waste listed on the manifest, matched to the relevant list number for the hazardous waste from block 9b. If additional space is needed, the exporter should use a Continuation Sheet(s) (EPA Form 8700-22A).

262.83(c)(4). Add new item (4) to adopt language that describes how the exporter may obtain the manifest from any source that is registered with the U.S. EPA as a supplier of manifests (e.g., states, waste handlers, and/or commercial forms printers).

262.83(d). Revise subsection to read, "Movement document requirements for export shipments:." Remove items (3) through (14) and note to (d)(14).

262.83(d)(1). Revise item to read, "All exporters must ensure that a movement document meeting the conditions of paragraph (d)(2) of this section accompanies each transboundary movement of hazardous wastes from the initiation of the shipment until it reaches the foreign receiving facility, including cases in which the hazardous waste is stored and/or sorted by the foreign importer prior to shipment to the foreign receiving facility, except as provided in paragraphs (d)(1)(i) and (ii) of this section." Add new items (1)(i) and (ii) to adopt language that describes the exceptions of paragraph (d)(1).

262.83(d)(2). Revise item to read, "The movement document must include the following paragraphs (d)(2)(i) through (xv) of this section:." Add new items (2)(i) through (xv) to adopt language that describes each requirement in the movement document.



262.83(e). Revise subsection to clarify the duty to return hazardous waste to the United States or re-export hazardous waste to a third country.

262.83(f). Add new subsection (f) titled, "Export contract requirements," and items (1) through (9) to adopt language that describes the exports of hazardous waste contract requirements.

262.83(g). Add new subsection (g) to adopt language that describes annual reports required by the exporters, and new items (1) through (6) to adopt language that describes the required content within the annual report.

262.83(h). Add new subsection (h) titled, "Exception reports," and new items (1) and (2) to adopt language that describes the required content within the exception reports.

262.83(i). Add new subsection (i) titled, "Recordkeeping," and new items (1) through (3) to adopt language that describes the recordkeeping requirements for exporters.

262.84. Revise section title to read, "Imports of hazardous waste."

262.84(a). Revise subsection heading to read, "General import requirements."

262.84(a)(1). Revise item to read, "With the exception of paragraph (a)(5) of this section, importers of shipments covered under a consent from EPA to the country of export issued before December 31, 2016, are subject to that approval and the requirements that existed at the time of that approval until such time the approval period expires. Otherwise, any other person who imports hazardous waste from a foreign country into the United States must comply with the requirements of this part and the special requirements of this subpart."

262.84(a)(2). Revise item to read, "In cases where the country of export does not require the foreign exporter to submit a notification and obtain consent to the export prior to shipment, the importer must submit a notification to EPA in accordance with paragraph (b) of this section."

262.84(a)(3). Add new item (3) to adopt language that describes how the importer must comply with the contract requirements in 262.84(f).

262.84(a)(4). Add new item (4) to adopt language that describes how the importer must ensure compliance with the movement documents requirements in 262.84(d).

262.84(a)(5). Add new item (5) to adopt language that describes how the importer must ensure compliance with the manifest instructions for import shipments in 262.84(c).

262.84(b). Revise subsection to read, "Notifications. In cases where the competent authority of the country of export does not regulate the waste as hazardous waste and, thus, does not require the foreign exporter to submit to it a notification proposing export and obtain consent from EPA and the competent authorities for the countries of transit, but EPA does regulate the waste as hazardous waste."

262.84(b)(1). Revise item to remove "Date movement commenced;" and adopt language that describes how the importer is required to provide notification of the transboundary movement of hazardous waste.

262.84(b)(2). Revise item to read, "Notifications listing interim recycling operations or interim disposal operations. If the receiving facility listed in paragraph (b)(1)(ii) of this section will engage in any of the

interim recovery operations R12 or R13 or interim disposal operations D13 through D15, the notification submitted according to paragraph (b)(1) of this section must also include the final recovery or disposal facility name, address, telephone and fax numbers, e-mail address, technologies employed, and which of the applicable recovery or disposal operations R1 through R11 and D1 through D12, will be employed at the final recovery or disposal facility. The recovery and disposal operations in this paragraph are defined in section 262.81.”

262.84(b)(3). Revise item to read, “Renotifications. When the foreign exporter wishes to change any of the conditions specified on the original notification (including increasing the estimate of the total quantity of hazardous waste specified in the original notification or adding transporters), the importer must submit a renotification of the changes to EPA using the allowable methods in paragraph (b)(1) of this section. Any shipment using the requested changes cannot take place until EPA and the countries of transit consent to the changes and the importer receives an EPA AOC letter documenting the consents to the changes.”

262.84(b)(4). Revise item to read, “A notification is complete when EPA determines the notification satisfies the requirements of paragraph (b)(1)(i) through (xiii) of this section.”

262.84(b)(5). Revise item to read, “Where EPA and the countries of transit consent to the proposed transboundary movement(s) of the hazardous waste(s), EPA will forward an EPA AOC letter to the importer documenting the countries’ consents and EPA’s consent. Where any of the countries of transit or EPA objects to the proposed transboundary movement(s) of the hazardous waste or withdraws a prior consent, EPA will notify the importer.”

262.84(b)(6). Revise item to read, “Export of hazardous wastes originally imported into the United States. Export of hazardous wastes that were originally imported into the United States for recycling or disposal operations is prohibited unless an exporter in the United States complies with the export requirements in section 262.83(b)(7).”

262.81(b)(7). Remove item (7).

262.84(c). Revise subsection title to read, “RCRA Manifest instructions for import shipments.” Add new items (1) through (5) to adopt language that describes the importer manifest requirements.

262.84(d). Revise subsection title to read, “Movement document requirements for import shipments.”

262.84(d)(1). Add new item (1) and items (1)(i) and (ii) to adopt language that describes how the importer must ensure that a movement document accompanies each transboundary movement of hazardous wastes.

262.84(d)(2). Add new item (2) and items (2)(i) through (xv) to adopt language that describes the requirements to be included in the movement document.

262.84(e). Revise to read, “Duty to return or export hazardous wastes. When a transboundary movement of hazardous wastes cannot be completed in accordance with the terms of the contract or the consent(s), the provisions of paragraph (f)(4) of this section apply. If alternative arrangements cannot be made to recover the hazardous waste in an environmentally sound manner in the United States, the hazardous waste must be returned to the country of export or exported to a third country. The provisions of paragraph (b)(6) of this section apply to any hazardous waste shipments to be exported to a third country. If the return shipment will cross any transit country, the return shipment may only occur after EPA provides notification to and obtains consent from the competent authority of the country of transit, and provides a copy of that consent to the importer.”

262.84(f). Add new subsection (f) titled, “Import contract requirements.”

262.84(f)(1). Add new item (1) to adopt language that describes how the imports of hazardous waste must occur under the terms of a valid written contract, chain of contracts, or equivalent arrangements (when the movement occurs between parties controlled by the same corporate or legal entity). Such contracts or equivalent arrangements must be executed by the foreign exporter, importer, and the owner or operator of the receiving facility, and must specify responsibilities for each. Contracts or equivalent arrangements are valid for the purposes of this section only if persons assuming obligations under the contracts or equivalent arrangements have appropriate legal status to conduct the operations specified in the contract or equivalent arrangements.

262.84(f)(2). Add new item (2) to adopt language that describes how the contracts or equivalent arrangements must specify the name and EPA ID number, where available, of 262.84(f)(2)(i) through (iv), which include: the foreign company from where each import shipment of hazardous waste is initiated; each person who will have physical custody of the hazardous wastes; each person who will have legal control of the hazardous wastes; and the receiving facility.

262.84(f)(3). Add new item (3) to adopt language that describes how contracts or equivalent arrangements must specify the use of a movement document in accordance with 262.84(d).

262.84(f)(4). Add new item (4) to adopt language that describes how contracts or equivalent arrangements must specify which party to the contract will assume responsibility for alternate management of the hazardous wastes. Add items (4)(i) and (4)(ii) to adopt language that describes what the contracts must specify.

262.84(f)(5). Add new item (5) to adopt language that describes how contracts must specify that the importer or the receiving facility that performed interim recycling operations R12, R13, or RC16, or interim disposal operations D13 through D15 or DC15 through DC17, as appropriate, will provide the notification required in section 262.83(b)(7) prior to the re-export of hazardous wastes. The recovery and disposal operations in this paragraph are defined in section 262.81.

262.84(f)(6). Add new item (6) to adopt new language that describes how contracts or equivalent arrangements must include provisions for financial guarantees, if required by the competent authorities of any countries concerned, in accordance with applicable national or international law requirements. Add new note to item (f)(6) that describes why financial guarantees are required.

262.84(f)(7). Add new item (7) to adopt new language that describes how contracts or equivalent arrangements must contain provisions requiring each contracting party to comply with all applicable requirements of Subpart F 262.

262.84(f)(8). Add new item (8) to adopt new language that describes how importers or disposal or recovery facilities must submit to EPA copies of contracts, chain of contracts, or equivalent arrangements (when the movement occurs between parties controlled by the same corporate or legal entity).

262.84(g). Add new subsection (g) to read, “Confirmation of recovery or disposal. The receiving facility must do the following:” to introduce receiving facility requirements. Add new items (1) and (2) to adopt language that describe the requirements of the receiving facility.

262.84(h). Add new subsection (h) titled, “Recordkeeping.”

262.84(h)(1). Add new item (1) and items (i) and (ii) to adopt language that describes the records the importer must keep and provide upon request.

262.84(h)(2). Add new item (2) and items (i) through (iv) to adopt language that describes the records the receiving facility must keep.

262.84(h)(3). Add new item (3) to adopt language that describes how importers and receiving facilities must satisfy the described recordkeeping requirements.

262.84(h)(4). Add new item (4) to adopt language that describes how the periods of retention referred to in this section are extended automatically during the course of any unresolved enforcement action regarding the regulated activity or as requested by the Department.

262.85. Remove and reserve subpart.

262.86. Remove and reserve subpart.

262.87. Remove and reserve subpart.

262.88. Add and reserve subpart.

262.89. Remove and reserve subpart.

Appendix to Part 262. Revise II Part 262, Item 16, Instructions for International Shipment Block, to remove the last sentence.

263.10(d). Revise subsection to read, “A transporter of hazardous waste that is being imported from or exported to any other country for purposes of recovery or disposal is subject to this subpart and to all other relevant requirements of R.61-79.262 subpart H, including, but not limited to, R.61-79.262.83(d) and 262.84(d) for movement documents.”

263.20(a)(2). Revise item to read, “Exports. For exports of hazardous waste subject to the requirements of part 262 subpart H, a transporter may not accept hazardous waste without a manifest signed by the generator in accordance with this section, as appropriate, and for exports occurring under the terms of a consent issued by EPA on or after December 31, 2016, a movement document that includes all information required by section 262.83(d).”

263.20(c). Revise subsection to clarify manifest transport requirements.

263.20(e)(2). Revise item to read, “A shipping paper containing all the information required on the manifest (excluding the EPA identification numbers, generator certification, and signatures) and, for exports or imports occurring under the terms of a consent issued by EPA on or after December 31, 2016, a movement document that includes all information required by sections 262.83(d) or 262.84(d) accompanies the hazardous waste; and.”

263.20(f)(2). Revise item to read, “Rail transporters must ensure that a shipping paper containing all the information required on the manifest (excluding the EPA identification numbers, generator certification, and signatures) and, for exports or imports occurring under the terms of a consent issued by EPA on or after December 31, 2016, a movement document that includes all information required by sections 262.83(d) or 262.84(d) accompanies the hazardous waste at all times..” Revise the note to remove “either” and add “, movement document,” after “manifest.”

263.20(g)(4). Revise item to remove the first sentence and add “For paper manifests only,.” Add new items (g)(4)(i) and (g)(4)(ii) to adopt language that describes how transporters must send a copy of the manifest to the e-Manifest system in accordance with the allowable methods specified in section 264.71(a)(2)(v), and, for shipments initiated prior to the AES filing compliance date, when instructed by the exporter to do so, give a copy of the manifest to a U.S. Customs official at the point of departure from the United States.

264.12(a). Revise subsection to read, “The owner or operator of a facility that is arranging or has arranged to receive hazardous waste subject to part 262 subpart H from a foreign source must submit the following required notices:.”

264.12(a)(1). Revise item to read, “As per section 262.84(b), for imports where the competent authority of the country of export does not require the foreign exporter to submit to it a notification proposing export and obtain consent from EPA and the competent authorities for the countries of transit, such owner or operator of the facility, if acting as the importer, must provide notification of the proposed transboundary movement in English to EPA using the allowable methods listed in section 262.84(b)(1) at least sixty (60) days before the first shipment is expected to depart the country of export. The notification may cover up to one year of shipments of wastes having similar physical and chemical characteristics, the same United Nations classification, the same RCRA waste codes and OECD waste codes, and being sent from the same foreign exporter.”

264.12(a)(2). Revise item to adopt language that describes the requirements of keeping a copy of the movement document.

264.12(a)(3). Add new item (3) to adopt language that describes how, as per section 262.84(f)(4), if the facility has physical control of the waste and it must be sent to an alternate facility or returned to the country of export, such owner or operator of the facility must inform EPA, using the allowable methods listed in section 262.84(b)(1) of the need to return or arrange alternate management of the shipment.

264.12(a)(4). Add new item (4) to adopt language that describes how, as per section 262.84(g), such owner or operator of a facility to receive hazardous waste from a foreign source must abide by (a)(4)(i) and (a)(4)(ii).

264.12(a)(4)(i). Add new item (4)(i) to adopt language that describes how the owner or operator shall send copies of the signed and dated confirmation of recovery or disposal, as soon as possible, but no later than thirty (30) days after completing recovery or disposal on the waste in the shipment and no later than one (1) calendar year following receipt of the waste, to the foreign exporter, to the competent authority of the country of export that controls the shipment as an export of hazardous waste, and for shipments recycled or disposed of on or after the electronic import-export reporting compliance date, to EPA electronically using WIETS, or its successor system.

264.12(a)(4)(ii). Add new item (4)(ii) to adopt language that describes how the owner or operator shall send copies of the confirmation of recovery or disposal that it receives from the final recovery or disposal facility within one (1) year of shipment delivery to the final recovery or disposal facility that performed one of recovery operations R1 through R11, or RC16, or one of disposal operations D1 through D12, or DC15 to DC16, to the competent authority of the country of export that controls the shipment as an export of hazardous waste, and on or after the electronic import-export reporting compliance date, to EPA electronically using EPA's WIETS, or its successor system. The recovery and disposal operations in this paragraph are defined in 40 CFR 262.81 if the facility performed any of recovery operations R12, R13, or RC16, or disposal operations D13 through D15, or DC17.

264.71(a)(3). Revise item to remove previous language and insert, “The owner or operator of a facility receiving hazardous waste subject to part 262 subpart H, from a foreign source must:.”

264.71(a)(3)(i). Add new item (3)(i) to adopt language that describes how the owner or operator of a facility receiving hazardous waste lists the relevant consent number from consent documentation supplied by EPA to the facility for each waste listed on the manifest, matched to the relevant list number for the waste from block 9b. If additional space is needed, the owner or operator should use a Continuation Sheet(s) (EPA Form 8700-22A).

264.71(a)(3)(ii). Add new item (3)(ii) to adopt language that describes how the owner or operator of a facility receiving hazardous waste sends a copy of the manifest within thirty (30) days of delivery to EPA using the addresses listed in section 262.82(e) until the facility can submit such a copy to the e-Manifest system per 264.71(a)(2)(v).

264.71(d). Revise subsection to adopt language that describes the requirements of keeping the movement document.

265.12(a). Revise subsection to read, “The owner or operator of a facility that is arranging or has arranged to receive hazardous waste subject to part 262 subpart H, from a foreign source must submit the following required notices.”

265.12(a)(1). Revise item to read, “As per section 262.84(b), for imports where the competent authority of the country of export does not require the foreign exporter to submit to it a notification proposing export and obtain consent from EPA and the competent authorities for the countries of transit, such owner or operator of the facility, if acting as the importer, must provide notification of the proposed transboundary movement in English to EPA using the allowable methods listed in section 262.84(b)(1) at least sixty (60) days before the first shipment is expected to depart the country of export. The notification may cover up to one year of shipments of wastes having similar physical and chemical characteristics, the same United Nations classification, the same RCRA waste codes and OECD waste codes, and being sent from the same foreign exporter.”

265.12(a)(2). Revise item to read, “As per section 262.84(d)(2)(xv), a copy of the movement document bearing all required signatures within three (3) working days of receipt of the shipment to the foreign exporter; to the competent authorities of the countries of export and transit that control the shipment as an export and transit shipment of hazardous waste respectively; and on or after the electronic import-export reporting compliance date, to EPA electronically using EPA’s WIETS, or its successor system. The original of the signed movement document must be maintained at the facility for at least three (3) years. The owner or operator of a facility may satisfy this recordkeeping requirement by retaining electronically submitted documents in the facility’s account on WIETS, or its successor system, provided that copies are readily available for viewing and production if requested by any EPA or authorized state inspector. No owner or operator of a facility may be held liable for the inability to produce the documents for inspection under this section if the owner or operator of a facility can demonstrate that the inability to produce the document is due exclusively to technical difficulty with WIETS, or its successor system, for which the owner or operator of a facility bears no responsibility.”

265.12(a)(3). Add new item (a)(3) to adopt language that describes how, if the facility has physical control of the waste and it must be sent to an alternate facility or returned to the country of export, such owner or operator of the facility must inform EPA, using the allowable methods listed in section 262.84(b)(1) of the need to return or arrange alternate management of the shipment, as per section 262.84(f)(4).

265.12(a)(4). Add new item (a)(4) and items (a)(4)(i) and (ii) to adopt language that describes how the owner or operator of a facility receiving hazardous waste from a foreign source must submit notices of confirmation of recovery or disposal.

265.71(a)(3). Revise item to read, “The owner or operator of a facility that receives hazardous waste subject to part 262 subpart H from a foreign source must:.”

265.71(a)(3)(i). Add new item (3)(i) to adopt language that describes how the owner or operator must list the relevant consent number from consent document supplied by EPA to the facility for each waste listed on the manifest, matched to the relevant list number for the waste from block 9b. If additional space is needed, the owner or operator should use a Continuation Sheet(s) (EPA Form 8700-22A).

265.71(a)(3)(ii). Add new item (3)(ii) to adopt language that describes how the owner or operator must send a copy of the manifest to EPA using the addresses listed in section 262.82(e) within thirty (30) days of delivery until the facility can submit such a copy to the e-Manifest system per 265.71(a)(2)(v).

265.71(d). Revise subsection to adopt language that describes the requirements of the owner or operator of a facility for the movement document.

266.70(b)(1). Revise item to clarify notification requirements.

266.70(b)(3). Revise item to read, “For precious metals exported to or imported from other countries for recovery, part 262, subpart H and 265.12.”

266.80(a)(6) Table 1-266.80 Applicability and requirements. Revise item, third column, to read, “are exempt from R.61-79.262 (except for R.61-79.262.11, 262.18 and subpart H), 263, 264, 265, 266, 268, 270, 124, and the notification requirements at the SC Hazardous Waste Management Act 44-56-120 and section 3010 of RCRA.” Revise fourth column to read, “are subject to R.61-79.261, 262.11, 262.18, and R.61-79.262 subpart H.” Remove items (6)(a) through (6)(c).

266.80(a)(7) Table 1-266.80 Applicability and requirements. Revise third column to read, “are exempt from R.61-79.263, 264, 265, 266, 268, 270, 124, and the notification requirements at the SC Hazardous Waste Management Act 44-56-120 and section 3010 of RCRA.” Revise fourth column to read, “must comply with applicable requirements in R.61-79.262, subpart H.” Remove items (7)(a) through (7)(c).

266.80(a)(8) Table 1-266.80 Applicability and requirements. Add new item (8) into Table 1-266.80 Applicability and requirements. Adopt new language in the first column to read, “Will be reclaimed other than through regeneration”; second column to read, “Import these batteries from foreign country and store these batteries but you aren’t the reclaimer”; third column to read, “are exempt from R.61-79.262 (except for R.61-79.262.11, 262.18 and subpart H), 263, 264, 265, 266, 270, 124, and the notification requirements at SC Hazardous Waste Management Act 44-56-120 and section 3010 of RCRA”; and fourth column to read, “are subject to R.61-79.261, 262.11, 262.18, 262 subpart H, and applicable provisions under R.61-79.268.”

266.80(a)(9) Table 1-266.80 Applicability and requirements. Add new item (9) into Table 1-266.80 Applicability and requirements. Adopt new language in the first column to read, “Will be reclaimed other than through regeneration”; second column to read, “Import these batteries from foreign country and store these batteries before you reclaim them”; third column to read, “must comply with 266.80(b) and as appropriate other regulatory provisions described in 266.80(b)”; and fourth column to read, “are subject to parts 261, section 262.11, section 262.18, part 262 subpart H, and applicable provisions under part 268.”

266.80(a)(10) Table 1-266.80 Applicability and requirements. Add new item (10) into Table 1-266.80 Applicability and requirements. Adopt new language in the first column to read, “Will be reclaimed other than through regeneration”; second column to read, “Import these batteries from foreign country and don’t store these batteries before you reclaim them”; third column to read, “are exempt from parts 262 (except for section 262.11, section 262.18 and subpart H), 263, 264, 265, 266, 270, 124, and the notification requirements at SC Hazardous Waste Management Act 44-56-120 and section 3010 of RCRA”; and fourth column to read, “are subject to parts 261, section 262.11, section 262.18, part 262 subpart H, and applicable provisions under part 268.”

273.20. Revise sentence to read, “A small quantity handler of universal waste who sends universal waste to a foreign destination is subject to the requirements of part 262, subpart H.”

273.39(a). Revise subsection to insert “, movement document” after “manifest, bill of lading.”

273.39(b). Revise subsection to insert “, movement document” after “manifest, bill of lading.”

273.40. Revise sentence to read, “A large quantity handler of universal waste who sends universal waste to a foreign destination is subject to the requirements of part 262, subpart H.”

273.56. Revise sentence to read, “A universal waste transporter transporting a shipment of universal waste to a foreign destination is subject to the requirements of part 262, subpart H.”

273.62(a). Revise subsection to insert “, movement document” after “manifest, bill of lading.”

273.70. Revise section to insert “the requirements of part 262 subpart H and” after “the United States are subject to.”

### **Notice of Public Hearing and Opportunity for Public Comment:**

Interested persons may submit written comment(s) on the proposed amendment by mail to David Scaturro in the Bureau of Land and Waste Management at the S.C. Department of Health and Environmental Control, 2600 Bull Street, Columbia, S.C. 29201; fax at (803)898-0590; or email at [scaturdm@dhec.sc.gov](mailto:scaturdm@dhec.sc.gov). To be considered, the Department must receive the comment(s) by 5:00 p.m. on November 26, 2018, the close of the comment period.

The S.C. Board of Health and Environmental Control will conduct a public hearing on the proposed amendment during its December 13, 2018, 10:00 a.m. meeting. Interested persons may make oral and/or submit written comments at the public hearing. Persons making oral comments should limit their statements to five (5) minutes or less. The meeting will take place in the Board Room of the DHEC Building, located at 2600 Bull Street, Columbia, S.C. 29201. Due to admittance procedures, all visitors must enter through the main Bull Street entrance and register at the front desk. The Department will publish a meeting agenda twenty-four (24) hours in advance indicating the order of its scheduled items at: <http://www.scdhec.gov/Agency/docs/AGENDA.PDF>.

The Department publishes a Monthly Regulation Development Update tracking the status of its proposed new regulations, amendments, and repeals and providing links to associated State Register documents at <http://www.scdhec.gov/Agency/RegulationsAndUpdates/RegulationDevelopmentUpdate/>.



## **Statement of Need and Reasonableness**

The following presents an analysis of the factors listed in 1976 Code Section 1-23-115(C)(1)-(3) and (9)-(11):

DESCRIPTION OF REGULATION: 61-79, Hazardous Waste Management Regulations

Purpose: The purpose of the amendment is to maintain state consistency with regulations of the United States Environmental Protection Agency (EPA), which published the final rule on November 28, 2016, at 81 FR 85696-85729.

Legal Authority: 1976 Code Section 44-56-30

Plan for Implementation: The DHEC Regulation Development Update (accessible at <http://www.scdhec.gov/Agency/RegulationsAndUpdates/RegulationDevelopmentUpdate/>) provides a summary of and link to this proposed amendment. Additionally, printed copies are available for a fee from the Department's Freedom of Information Office. Upon taking legal effect, Department personnel will take appropriate steps to inform the regulated community of the amendment and any associated information.

### **DETERMINATION OF NEED AND REASONABLENESS OF THE PROPOSED REGULATION BASED ON ALL FACTORS HEREIN AND EXPECTED BENEFITS:**

The Bureau of Land and Waste Management proposes adopting the Imports and Exports of Hazardous Waste Rule published on November 28, 2016, at 81 FR 85696-85729. The rule amends the existing import and export of hazardous wastes regulations from and into the United States. This rule provides greater protection to human health and the environment by making existing import- and export-related requirements more consistent with the current import-export requirements for shipments between member of the Organization for Economic Cooperation and Development (OECD), enables electronic submittal to EPA of all import- and export-related documents, and enables electronic validation of consent in the Automated Export System (AES) for export shipments subject to RCRA export consent requirements prior to exit. Adoption of this rule is required to comply with federal law and will bring R.61-79 into conformity with the federal regulation.

### **DETERMINATION OF COSTS AND BENEFITS:**

These regulatory amendments are exempt from the requirements of a Preliminary Fiscal Impact Statement or a Preliminary Assessment Report because the proposed changes are necessary to maintain compliance with federal law.

There is no anticipated increased cost to the state or its political subdivisions resulting from this proposed revision. There will likely be a slight increase in costs to the regulated community for compliance from this proposed revision. Amendments to R.61-79 will make existing import- and export-related requirements more consistent with the current import-export requirements for shipments between members of the Organization for Economic Cooperation and Development, enable electronic submittal to the EPA of all import- and export-related documents, and enable electronic validation of consent in the Automated Export System for export shipments to the RCRA export consent requirements prior to exit.

### **UNCERTAINTIES OF ESTIMATES:**

There are no uncertainties of estimates relative to the costs to the state or its political subdivisions.

EFFECT ON THE ENVIRONMENT AND PUBLIC HEALTH:

The proposed revision to R.61-79 will provide continued protection of the environment and human health in accordance with updates to federal law.

DETRIMENTAL EFFECT ON THE ENVIRONMENT AND PUBLIC HEALTH IF THE REGULATION IS NOT IMPLEMENTED:

If the regulation is not implemented the EPA's delegation of authority to the state to implement environmental protection programs would be compromised. As a delegated state program, the EPA requires that the state's regulations be at least as stringent as, and equivalent to, the federal regulations. Adoption of these proposed revisions will ensure equivalency with federal requirements.

**Text:**

~~Indicates Matter Stricken~~

Indicates New Matter

61-79. Hazardous Waste Management Regulations.

Statutory Authority: 1976 Code Section 44-56-30

**Revise 61-79.260.10 to add the following definitions in alphabetical order within this s**

**"AES filing compliance date"** ~~is the date, not later than~~ December 31, 2017, which is the date that EPA announced in the Federal Register, on or after which exporters of hazardous waste and exporters of cathode ray tubes for recycling are required to file EPA information in the Automated Export System or its successor system, under the International Trade Data System (ITDS) platform.

**"Electronic import-export reporting compliance date"** ~~is the date, not later than~~ that EPA announces in the Federal Register, on or after which exporters, importers, and receiving facilities are required to submit certain export and import related documents to EPA using EPA's Waste Import Export Tracking System, or its successor system.

**"Recognized trader"** ~~is~~ a person domiciled in the United States, by site of business, who acts to arrange and facilitate transboundary movements of wastes destined for recovery or disposal operations, either by purchasing from and subsequently selling to United States and foreign facilities, or by acting under arrangements with a United States waste facility to arrange for the export or import of the wastes.

**Revise 61-79.261.4(d)(1) to read:**

(1) Except as provided in paragraph (d)(2) and (4) of this section, a sample of solid waste or a sample of water, soil, or air, which is collected for the sole purpose of testing to determine its characteristics or composition, is not subject to any requirements of this part or ~~R.61-79.262 through R.61-79.266, R.61-79.268, R.61-79.270, or R.61-79.124~~ parts 262 through 268 or part 270 or part 124 of this chapter or to the notification requirements of section 3010 of RCRA and the South Carolina Hazardous Waste Management Act 44-56-120 when:

**Revise 61-79.261.4(d)(4) to read:**

(4) In order to qualify for the exemption in paragraphs (d)(1)(i) and (ii) of this section, the mass of a sample that will be exported to a foreign laboratory or that will be imported to a U.S. laboratory from a foreign source must additionally not exceed twenty-five (25) kilograms.

**Revise 61-79.261.4(e)(1) to read:**

(1) Except as provided in paragraph (e)(2) and (4) of this section, persons who generate or collect samples for the purpose of conducting treatability studies as defined in ~~section R.61-79.260.10~~, are not subject to any requirement of ~~parts 261 through 263 of this chapter~~R.61-79.261 through 263 or to the notification requirements of SC Hazardous Waste Management Act 44-56-120 and Section 3010 of RCRA, nor are such samples included in the quantity determinations of ~~261.5 and 262.34(d)~~R.61-79.262.13 when:

**Revise 61-79.261.4(e)(4) to read:**

(4) In order to qualify for the exemption in R.61-79.261.4(e)(1)(i), the mass of a sample that will be exported to a foreign laboratory or testing facility, or that will be imported to a U.S. laboratory or testing facility from a foreign source must additionally not exceed twenty-five (25) kilograms.

**Revise 61-79.261.6(a)(3)(i) to read:**

(i) Industrial ethyl alcohol that is reclaimed except that, ~~unless provided otherwise in an international agreement as specified in 262.58:~~ exports and imports of such recyclable materials must comply with the requirements of R.61-79.262 subpart H.

**Revise 61-79.261.6(a)(5) to read:**

(5) Hazardous waste that is exported ~~to~~ or imported ~~from designated member countries of the Organization for Economic Cooperation and Development (OECD) (as defined in 262.58(a)(1))~~ for purpose of recovery is subject to the requirements of ~~40 CFR part 262, R.61-79.262 subpart H, if it is subject to either the federal manifesting requirements of Part 262, to the universal waste management standards of Part 273.~~

**Revise 61-79.261.39(a)(5)(ii) to read:**

(ii) Notifications ~~must be submitted by mail should be sent to the following mailing address: Office of Enforcement and Compliance Assurance, Office of Federal Activities, International Compliance Assurance Division, (Mail Code 2254A), Environmental Protection Agency, 1200 Pennsylvania Ave., NW., Washington, DC 20460. Hand delivered notifications should be sent to: Office of Enforcement and Compliance Assurance, Office of Federal Activities, International Compliance Assurance Division, (Mail Code 2254A), Environmental Protection Agency, Ariel Rios Bldg., Room 6144, 1200 Pennsylvania Ave., NW., Washington, DC. In both cases, the following shall be prominently displayed on the front of the envelope: "Attention: Notification of Intent to Export CRTs." electronically using EPA's Waste Import Export Tracking System (WIETS), or its successor system.~~

**Revise 61-79.261.39(a)(5)(v) to read:**

(v) The export of CRTs is prohibited unless all of the following occur: the receiving country consents to the intended export. When the receiving country consents in writing to the receipt of the CRTs, EPA will forward an Acknowledgment of Consent to Export CRTs to the exporter. Where the receiving

~~country objects to receipt of the CRTs or withdraws a prior consent, EPA will notify the exporter in writing. EPA will also notify the exporter of any responses from transit countries.~~

~~(A) The receiving country consents to the intended export. When the receiving country consents in writing to the receipt of the CRTs, EPA will forward an Acknowledgement of Consent to Export CRTs to the exporter. Where the receiving country objects to receipt of the CRTs or withdraws a prior consent, EPA will notify the exporter in writing. EPA will also notify the exporter of any responses from transit countries.~~

~~(B) On or after the AES filing compliance date, the exporter or a U.S. authorized agent must:~~

~~(1) Submit Electronic Export Information (EEI) for each shipment to the Automated Export System (AES) or its successor system, under the International Trade Data System (ITDS) platform, in accordance with 15 CFR 30.4(b).~~

~~(2) Include the following items in the EEI, along with the other information required under 15 CFR 30.6:~~

~~(i) EPA license code;~~

~~(ii) Commodity classification code per 15 CFR 30.6(a)(12);~~

~~(iii) EPA consent number;~~

~~(iv) Country of ultimate destination per 15 CFR 30.6(a)(5);~~

~~(v) Date of export per 15 CFR 30.6(a)(2);~~

~~(vi) Quantity of waste in shipment and units for reported quantity, if required reporting units established by value for the reported commodity classification number are in units of weight or volume per 15 CFR 30.6(a)(15); or~~

~~(vii) EPA net quantity reported in units of kilograms, if required reporting units established by value for the reported commodity classification number are not in units of weight or volume.~~

**Revise 61-79.261.39(a)(5)(vi) to read:**

(vi) When the conditions specified on the original notification change, the exporter must provide EPA with a written renotification of the change using the allowable methods listed in paragraph (a)(5)(ii) of this section, except for changes to the telephone number in paragraph (a)(5)(i)(A) of this section and decreases in the quantity indicated pursuant to paragraph (a)(5)(i)(C) of this section. The shipment cannot take place until consent of the receiving country to the changes has been obtained (except for changes to information about points of entry and departure and transit countries pursuant to paragraphs (a)(5)(i)(D) and ~~(a)(5)(i)(H)~~ of this section) and the exporter of CRTs receives from EPA a copy of the Acknowledgment of Consent to Export CRTs reflecting the receiving country's consent to the changes.

**Revise 61-79.261.39(a)(5)(ix) to read:**

(ix) Exporters must keep copies of notifications and Acknowledgments of Consent to Export CRTs for a period of three years following receipt of the Acknowledgment. Exporters may satisfy this recordkeeping requirement by retaining electronically submitted notifications or electronically generated

Acknowledgements in the CRT exporter's account on EPA's Waste Import Export Tracking System (WIETS), or its successor system, provided that such copies are readily available for viewing and production if requested by any EPA or authorized state inspector. No CRT exporter may be held liable for the inability to produce a notification or Acknowledgement for inspection under this section if the CRT exporter can demonstrate that the inability to produce such copies is due exclusively to technical difficulty with WIETS, or its successor system for which the CRT exporter bears no responsibility.

**Revise 61-79.261.39(a)(5)(xi) to read:**

(xi) Annual reports must be submitted to the office specified in paragraph (a)(5)(ii) of this section. Exporters must keep copies of each annual report for a period of at least three (3) years from the due date of the report. Prior to one (1) year after the AES filing compliance date, annual reports must be sent to the following mailing address: Office of Land and Emergency Management, Office of Resource Conservation and Recovery, Materials Recovery and Waste Management Division, International Branch (Mail Code 2255A), Environmental Protection Agency, 1200 Pennsylvania Ave., NW., Washington, DC 20460. Hand-delivered annual reports on used CRTs exported during 2016 should be sent to: Office of Land and Emergency Management, Office of Resource Conservation and Recovery, Materials Recovery and Waste Management Division, International Branch (Mail Code 2255A), Environmental Protection Agency, William Jefferson Clinton South Building, Room 6144, 1200 Pennsylvania Ave. NW, Washington, DC 20004. Subsequently, annual reports must be submitted to the office listed using the allowable methods specified in paragraph (a)(5)(ii) of this section. Exporters must keep copies of each annual report for a period of at least three (3) years from the due date of the report. Exporters may satisfy this recordkeeping requirement by retaining electronically submitted annual reports in the CRT exporter's account on EPA's Waste Import Export Tracking System (WIETS), or its successor system, provided that a copy is readily available for viewing and production if requested by any EPA or authorized state inspector. No CRT exporter may be held liable for the inability to produce an annual report for inspection under this section if the CRT exporter can demonstrate that the inability to produce the annual report is due exclusively to technical difficulty with WIETS, or its successor system for which the CRT exporter bears no responsibility.

**Revise 61-79.262.10(d) to read:**

(d) Any person who exports or imports wastes that are considered hazardous under U.S. national procedures to or from the countries listed in 262.58(a)(1) for recovery must comply with subpart H of this part. A waste is considered hazardous under U.S. national procedures if the waste meets the federal definition of hazardous waste in 40 CFR 261.3 and is subject to either the Federal RCRA manifesting requirements at part 262, subpart B, the universal waste management standards of part 273, State requirements analogous to part 273, the export requirements in the spent lead acid battery management standards of part 266, subpart G, or State requirements analogous to the export requirements analogous to the export requirements in part 266, subpart G. Any person who exports or imports hazardous wastes must comply with R.61-79.262.18 and R.61-79.262 subpart H.

**Revise 61-79.262.41(c) to read:**

(c) Any generator must submit the information required by paragraph (a) on a form designated by the Department and according to the instructions included with such form. Reporting for exports of hazardous waste is not required on the Report form. A separate annual report requirement is set forth at 262.56 section 262.83(g) for hazardous waste exporters.

**Revise 61-79.262 Subpart E to remove and reserve:**

**SUBPART E: ~~Special Conditions-Exports of Hazardous Waste~~**

## **262.50 Applicability.**

~~—This subpart establishes requirements applicable to exports of hazardous waste. Except to the extent Section 262.58 provides otherwise, a primary exporter of hazardous waste must comply with the special requirements of this subpart and a transporter transporting hazardous waste for export must comply with applicable requirements of R.61-79.263. Section 262.58 sets forth the requirements of international agreements between the United States and receiving countries which establish different notice, export, and enforcement procedures for the transportation, treatment, storage and disposal of hazardous waste for shipments between the United States and those countries.~~

## **262.51 Definitions.**

~~—In addition to the definitions set forth at R.61-79.260.10, the following definitions apply to this subpart:~~

~~—**"Consignee"** means the ultimate treatment, storage or disposal facility in a receiving country to which the hazardous waste will be sent.~~

~~—**"EPA Acknowledgment of Consent"** means the cable sent to EPA and to the Department from the U.S. Embassy in a receiving country that acknowledges the written consent of the receiving country to accept the hazardous waste and describes the terms and conditions of the receiving country's consent to the shipment.~~

~~—**"Primary Exporter"** means any person who is required to originate the manifest for a shipment of hazardous waste in accordance with R.61-79.262, Subpart B, which specifies a treatment, storage, or disposal facility in a receiving country as the facility to which the hazardous waste will be sent and any intermediary arranging for the export.~~

~~—**"Receiving Country"** means a foreign country to which a hazardous waste is sent for the purpose of treatment, storage or disposal (except short term storage incidental to transportation).~~

~~—**"Transit Country"** means any foreign country, other than a receiving country, through which a hazardous waste is transported.~~

## **262.52 General requirements.**

~~—Exports of hazardous waste are prohibited except in compliance with the applicable requirements of this Subpart and R.61-79.263. Exports of hazardous waste are prohibited unless:~~

~~—(a) Notification in accordance with Section 262.53 has been provided;~~

~~—(b) The receiving country has consented to accept the hazardous waste;~~

~~—(c) A copy of the EPA Acknowledgment of Consent to the shipment accompanies the hazardous waste shipment and, unless exported by rail, is attached to the manifest [or shipping paper for exports by water (bulk shipment)].~~

~~—(d) The hazardous waste shipment conforms to the terms of the receiving country's written consent as reflected in the EPA Acknowledgment of Consent.~~

## **262.53 Notification of intent to export.**

~~—(a) A primary exporter in this State of hazardous waste must notify EPA and the Department of an intended export before such waste is scheduled to leave the United States. A complete notification should be submitted sixty (60) days before the initial shipment is intended to be shipped offsite. This notification may cover export activities extending over a twelve (12) month or lesser period. The notification must be in writing, signed by the primary exporter, and include the following information:~~

~~—(1) Name, mailing address, telephone number and EPA ID number of the primary exporter;~~

~~—(2) By consignee, for each hazardous waste type:~~

~~—(i) A description of the hazardous waste and the EPA hazardous waste number (from R.61-79.261, Subparts C and D), U.S. DOT proper shipping name, hazard class and ID number (UN/NA) for each hazardous waste, as identified in 49 CFR Part 171-177.~~

~~—(ii) The estimated frequency or rate at which such waste is to be exported and the period of time over which such waste is to be exported.~~

~~—(iii) The estimated total quantity of the hazardous waste in units as specified in the instructions to the Uniform Hazardous Waste Manifest Form (8700-12 DHEC);~~

~~—(iv) All points of entry to and departure from each foreign country through which the hazardous waste will pass;~~

~~—(v) A description of the means by which each shipment of the hazardous waste will be transported (e.g., mode of transportation vehicle (air, highway, rail, water, etc.), type(s) of container (drums, boxes, tanks, etc.);~~

~~—(vi) A description of the manner in which the hazardous waste will be treated, stored or disposed of in the receiving country (e.g., land or ocean incineration, other land disposal, ocean dumping, recycling);~~

~~—(vii) The name and site address of the consignee and any alternate consignee; and~~

~~—(viii) The name of any transit countries through which the hazardous waste will be sent and a description of the approximate length of time the hazardous waste will remain in such country and the nature of its handling while there;~~

~~—(b) Notifications submitted by mail should be sent to the following mailing address: Office of Federal Activities, International Compliance Assurance Division (2254A), Environmental Protection Agency, 401 M St., SW., Washington, DC 20460. Hand-delivered notifications should be sent to: Office of Federal Activities, International Compliance Assurance Division, Environmental Protection Agency, Ariel Rios Bldg., Room 6144, 12th St., and Pennsylvania Ave., NW., Washington, DC, 20004. In both cases, the following shall be prominently displayed on the front of the envelope: "Attention: Notification of Intent to Export." (revised 12/93)~~

~~—(c) Except for changes to the telephone number in paragraph(a)(1) of this section, changes to paragraph (a)(2)(v) of this section and decreases in the quantity indicated pursuant to paragraph (a)(2)(iii) of this section when the conditions specified on the original notification change (including any exceedance of the estimate of the quantity of hazardous waste specified in the original notification), the primary exporter must provide EPA and the Department with a written renotification of the change. The shipment cannot take place until consent of the receiving country to the changes (except for changes to paragraph (a)(2)(viii) of this section and in the ports of entry to and departure from transit countries pursuant to paragraph~~

(a)(2)(iv) of this section) has been obtained and the primary exporter receives an EPA Acknowledgment of Consent reflecting the receiving country's consent to the changes.

~~—(d) Upon request by either EPA or the Department, a primary exporter shall furnish to EPA and the Department any additional information which a receiving country requests in order to respond to a notification.~~

~~—(e) In conjunction with the Department of State, EPA will provide a complete notification to the receiving country and any transit countries. A notification is complete when EPA and the Department receives a notification which EPA determines satisfies the requirements of paragraph (a) of this section. Where a claim of confidentiality is asserted with respect to any notification information required by paragraph (a) of this section, EPA may find the notification not complete until any such claim is resolved in accordance with R.61-79.260.2.~~

~~—(f) Where the receiving country consents to the receipt of the hazardous waste, EPA will forward an EPA Acknowledgment of Consent to the primary exporter for purposes of Section 262.54(h). Where the receiving country objects to receipt of the hazardous waste or withdraws a prior consent, EPA will notify the primary exporter in writing, EPA will also notify the primary exporter of any responses from transit countries.~~

## **262.54 Special manifest requirements.**

~~—A primary exporter must comply with the manifest requirements of Sections 262.20 through 262.23 except that:~~

~~—(a) In lieu of the name, site address and EPA ID number of the designated permitted facility, the primary exporter must enter the name and site address of the consignee;~~

~~—(b) In lieu of the name, site address and EPA ID number of a permitted alternate facility, the primary exporter may enter the name and site address of any alternate consignee.~~

~~—(c) In the International Shipments block, the primary exporter must check the export box and enter the point of exit (city and state) from the United States.~~

~~—(d) The following statement must be added to the end of the first sentence of the certification set forth in Item 16 of the Uniform Hazardous Waste Manifest Form: "and conforms to the terms of the attached EPA Acknowledgment of Consent";~~

~~—(e) The primary exporter may obtain the manifest from any source that is registered with the U.S. EPA as a supplier of manifests (e.g., states, waste handlers, and/or commercial forms printers).~~

~~—(f) The primary exporter must require the consignee to confirm in writing the delivery of the hazardous waste to that facility and to describe any significant discrepancies (as defined in 264.72(a)) between the manifest and the shipment. A copy of the manifest signed by such facility may be used to confirm delivery of the hazardous waste.~~

~~—(g) In lieu of the requirements of Section 262.20(d), where a shipment cannot be delivered for any reason to the designated or alternate consignee, the primary exporter must:~~



~~— (1) Renotify EPA and the Department of a change in the conditions of the original notification to allow shipment to a new consignee in accordance with Section 262.53(e) and obtain an EPA Acknowledgment of Consent prior to delivery; or~~

~~— (2) Instruct the transporter to return the waste to the primary exporter in the United States or designate another facility within the United States; and~~

~~— (3) Instruct the transporter to revise the manifest in accordance with the primary exporter's instructions.~~

~~— (h) The primary exporter must attach a copy of the EPA Acknowledgment of Consent to the shipment to the manifest which must accompany the hazardous waste shipment. For exports by rail or water (bulk shipment), the primary exporter must provide the transporter with an EPA Acknowledgment of Consent which must accompany the hazardous waste but which need not be attached to the manifest except that for exports by water (bulk shipment) the primary exporter must attach the copy of the EPA Acknowledgment of Consent to the shipping paper.~~

~~— (i) The primary exporter shall provide the transporter with an additional copy of the manifest for delivery to the U.S. Customs official at the point the hazardous waste leaves the United States in accordance with R.61-79.263.20(g)(4).~~

### **~~262.55 Exception reports.~~**

~~— In lieu of the requirements of 262.42, a primary exporter must file an exception report with the Office of Enforcement and Compliance Assurance, Office of Federal Activities, International Compliance Assurance Division (2254A), Environmental Protection Agency, 1200 Pennsylvania Avenue, NW., Washington, DC 20460, if any of the following occurs:~~

~~— (a) He has not received a copy of the manifest signed by the transporter stating the date and place of departure from the United States within forty five (45) days from the date it was accepted by the initial transporter;~~

~~— (b) Within ninety (90) days from the date the waste was accepted by the initial transporter, the primary exporter has not received written confirmation from the consignee that the hazardous waste was received;~~

~~— (c) The waste is returned to the United States.~~

### **~~262.56 Annual reports.~~**

~~— (a) Primary exporters of hazardous waste shall file with the EPA Administrator and the Department no later than March 1 of each year, a report summarizing the types, quantities, frequency, and ultimate destination of all hazardous waste exported during the previous calendar year. Such reports shall include the following:~~

~~— (1) The EPA identification number, name, and mailing and site address of the exporter;~~

~~— (2) The calendar year covered by the report;~~

~~— (3) The name and site address of each consignee;~~

~~— (4) By consignee, for each hazardous waste exported, a description of the hazardous waste, the EPA hazardous waste number from part 261, subpart C or D), DOT hazard class, the name and US EPA ID number (where applicable) for each transporter used, the total amount of waste shipped and number of shipments pursuant to each notification;~~

~~— (5) Except for hazardous waste produced by exporters of greater than 100 kilograms but less than 1000 kilograms in a calendar month, unless provided pursuant to 262.41 (quarterly reporting), in even numbered years: (amended 6/89)~~

~~— (i) A description of the efforts undertaken during the year to reduce the volume and toxicity of waste generated; and~~

~~— (ii) A description of the changes in volume and toxicity of waste actually achieved during the year in comparison to previous years to the extent such information is available for years prior to 1984.~~

~~— (6) A certification signed by the primary exporter which states:~~

~~— I certify under penalty of law that I have personally examined and am familiar with the information submitted in this and all attached documents, and that based on my inquiry of those individuals immediately responsible for obtaining the information, I believe that the submitted information is true, accurate, and complete. I am aware that there are significant penalties for submitting false information including the possibility of fine and imprisonment.~~

~~— (b) Reports shall be sent to the following mailing addresses: Office of Federal Activities, International Compliance Assurance Division (2254A), Environmental Protection Agency, 401 M St., SW., Washington, DC 20460 and the Bureau of Land and Waste Management, Department of Health and Environmental Control, 2600 Bull Street, Columbia, SC 29201. (amended 11/90; 12/93)~~

## **262.57 Recordkeeping.**

~~— (a) For all exports a primary exporter must:~~

~~— (1) Keep a copy of each notification of intent to export for a period of at least three years from the date the hazardous waste was accepted by the initial transporter;~~

~~— (2) Keep a copy of each EPA Acknowledgment of Consent for a period of at least three years from the date the hazardous waste was accepted by the initial transporter;~~

~~— (3) Keep a copy of each confirmation of delivery of the hazardous waste from the consignee for at least three years from the date the hazardous waste was accepted by the initial transporter; and~~

~~— (4) Keep a copy of each annual report for a period of at least three years from the due date of the report.~~

~~— (b) The periods of retention referred to in this section are extended automatically during the course of any unresolved enforcement action regarding the regulated activity or as requested by the EPA Administrator or the Department.~~

## **262.58 International agreements.**

~~— (a) Any person who exports or imports wastes that are considered hazardous under U.S. national procedures to or from designated Member countries of the Organization for Economic Cooperation and~~

~~Development (OECD) as defined in paragraph (a)(1) of this section for purposes of recovery is subject to subpart H of this part. The requirements of subparts E and F of this part do not apply to such exports and imports. A waste is considered hazardous under U.S. national procedures if the waste meets the Federal definition of hazardous waste in part 261.3 and is subject to either the Federal RCRA manifesting requirements at part 262, subpart B, the universal waste management standards of part 273, state requirements analogous to part 273, the export requirements in the spent lead acid battery management standards of part 266, subpart G or state requirements analogous to the export requirements of part 266, subpart G.~~

~~— (1) For the purposes of Subpart H, the designated OECD countries consist of Australia, Austria, Belgium, Czech Republic, Denmark, Finland, France, Germany, Greece, Hungary, Iceland, Ireland, Italy, Japan, Luxembourg, the Netherlands, New Zealand, Norway, Poland, Portugal, the Slovak Republic, the Republic of Korea, Spain, Sweden, Switzerland, Turkey, the United Kingdom, and the United States.~~

~~— (2) For the purposes of this Subpart, Canada and Mexico are considered OECD member countries only for the purpose of transit.~~

~~— (b) Any person who exports hazardous waste to or imports hazardous waste from: a designated OECD Member country for purposes other than recovery (e.g., incineration, disposal), Mexico (for any purpose), or Canada (for any purpose) remains subject to the requirements of subparts E and F of this part and is not subject to the requirements of subpart H of this part. [Reserved]~~

## **Revise 61-79.262 Subpart F to remove and reserve:**

### **SUBPART F: Imports of Hazardous Waste**

#### **262.60 Imports of hazardous waste.**

~~— (a) Any person who imports hazardous waste from a foreign country into this State must comply with the requirements of these Regulations and the special requirements of this subpart.~~

~~— (b) When importing hazardous waste, a person must meet all the requirements of 262.20 for the manifest except that:~~

~~— (1) In place of the generator's name, address and EPA identification number, the name and address of the foreign generator and the importer's name, address and EPA identification number must be used.~~

~~— (2) In place of the generator's signature on the certification statement, the U.S. importer or his agent must sign and date the certification and obtain the signature of the initial transporter.~~

~~— (c) A person who imports hazardous waste may obtain the manifest form from any source that is registered with the U.S. EPA as a supplier of manifests (e.g., states, waste handlers, and/or commercial forms printers).~~

~~— (d) In the International Shipments block, the importer must check the import box and enter the point of entry (city and state) into the United States.~~

~~— (e) The importer must provide the transporter with an additional copy of the manifest to be submitted by the receiving facility to U.S. EPA in accordance with 264.71(a)(3) and 265.71(a)(3) of this chapter. [Reserved]~~

**Revise 61-79.262 Subpart H title to read:**

Subpart H: Transboundary Movements of Hazardous Waste for Recovery ~~within the OECD~~ and Disposal

**Revise 61-79.262.80(a) to read:**

(a) The requirements of this subpart apply to ~~imports and exports of wastes that are considered hazardous under U.S. national procedures and are destined for recovery operations in the countries listed in 262.58(a)(1). A waste is considered hazardous under U.S. national procedures if the waste:~~ transboundary movements of hazardous wastes.

**Revise 61-79.262.80(b) to read:**

(b) Any person (including exporter, importer, disposal facility operator, or recovery facility operator) who mixes two or more wastes (including hazardous and nonhazardous wastes) or otherwise subjects two or more wastes (including hazardous and nonhazardous wastes) to physical or chemical transformation operations, and thereby creates a new hazardous waste, becomes a generator and assumes all subsequent generator duties under RCRA and the SC Hazardous Waste Management Act and any exporter duties, if applicable, under this subpart.

**Revise 61-79.262.81 to read:**

~~In addition to the definitions set forth at R.61-79.260.10,~~ The following definitions apply to this subpart.:

**"Competent authority"** ~~is the regulatory authority or authorities of concerned countries having jurisdiction over transboundary movements of wastes destined for recovery operations.~~

**"Countries concerned"** ~~is the OECD member countries of export or import and any OECD member countries of transit.~~

**"Country of export"** ~~is any designated OECD Member country listed in 262.58(a)(1) from which a transboundary movement of hazardous wastes is planned to be initiated or is initiated.~~

**"Country of import"** ~~is any designated OECD Member country listed in 262.58(a)(1) to which a transboundary movement of hazardous wastes is planned or takes place for the purpose of submitting the wastes to recovery or disposal operations therein.~~

**"Country of transit"** ~~is any designated OECD Member country listed in 262.58(a)(1) and (a)(2) other than the country of export or country of import across which a transboundary movement of hazardous wastes is planned or takes place.~~

**"Disposal operations"** activities which do not lead to the possibility of resource recovery, recycling, reclamation, direct re-use or alternate uses, which include:

(1) D1 Release or Deposit into or onto land, other than by any of operations D2 through D5 or D12.

(2) D2 Land treatment, such as biodegradation of liquids or sludges in soils.

(3) D3 Deep injection, such as injection into wells, salt domes or naturally occurring repositories.

(4) D4 Surface impoundment, such as placing of liquids or sludges into pits, ponds or lagoons.

(5) D5 Specially engineered landfill, such as placement into lined discrete cells which are capped and isolated from one another and the environment.

(6) D6 Release into a water body other than a sea or ocean, and other than by operation D4.

(7) D7 Release into a sea or ocean, including sea-bed insertion, other than by operation D4.

(8) D8 Biological treatment not specified elsewhere in operations D1 through D12, which results in final compounds or mixtures which are discarded by means of any of operations D1 through D12.

(9) D9 Physical or chemical treatment not specified elsewhere in operations D1 through D12, such as evaporation, drying, calcination, neutralization, or precipitation, which results in final compounds or mixtures which are discarded by means of any of operations D1 through D12.

(10) D10 Incineration on land.

(11) D11 Incineration at sea.

(12) D12 Permanent storage.

(13) D13 Blending or mixing, prior to any of operations D1 through D12.

(14) D14 Repackaging, prior to any of operations D1 through D13.

(15) D15 (or DC17 for transboundary movements with Canada only) Interim Storage, prior to any of operations D1 through D12.

(16) DC15 Release, including the venting of compressed or liquified gases, or treatment, other than by any of operations D1 to D12 (for transboundary movements with Canada only).

(17) DC16 Testing of a new technology to dispose of a hazardous waste (for transboundary movements with Canada only).

**“EPA Acknowledgment of Consent”** means the letter EPA sends to the exporter documenting the specific terms of the country of import’s consent and the country(ies) of transit’s consent(s). The AOC meets the definition of an export license in U.S. Census Bureau regulations 15 CFR 30.1.

**“Export”** means the transportation of hazardous waste from a location under the jurisdiction of the United States to a location under the jurisdiction of another country, or a location not under the jurisdiction of any country, for the purposes of recovery or disposal operations therein.

**“Exporter”** also known as primary exporter on the RCRA hazardous waste manifest, means the person under the jurisdiction of the country of export who has, or will have at the time the planned transboundary movement commences, possession or other forms of legal control of the wastes and who proposes transboundary movement of the hazardous wastes for the ultimate purpose of submitting them to recovery operations. When the United States (U.S.) is the country of export, exporter is interpreted to mean a person domiciled in the United States, who is required to originate the movement document in accordance with R.61-79.262.83(d) or the manifest for a shipment of hazardous waste in accordance with R.61-79.262 subpart B of this part, or equivalent state provision, which specifies a foreign receiving facility as the facility

to which the hazardous wastes will be sent, or any recognized trader who proposes export of the hazardous wastes for recovery or disposal operations in the country of import.

**"Foreign exporter"** means the person under the jurisdiction of the country of export who has, or will have at the time the planned transboundary movement commences, possession or other forms of legal control of the hazardous wastes and who proposes shipment of the hazardous wastes to the United States for recovery or disposal operations.

**"Foreign importer"** means the person to whom possession or other form of legal control of the hazardous waste is assigned at the time the exported hazardous waste is received in the country of import.

**"Foreign receiving facility"** a facility which, under the importing country's applicable domestic law, is operating or is authorized to operate in the country of import to receive the hazardous wastes and to perform recovery or disposal operations on them.

**"Import"** means the transportation of hazardous waste from a location under the jurisdiction of another country to a location under the jurisdiction of the United States for the purposes of recovery or disposal operations therein.

**"Importer"** means the person to whom possession or other form of legal control of the hazardous waste is assigned at the time the imported hazardous waste is received in the country of import the United States.

**"OECD"** means the Organization for Economic Cooperation and Development.

**"OECD area"** means all land or marine areas under the national jurisdiction of any OECD Member country listed in 262.58. When the regulations refer to shipments to or from an OECD Member country, this means OECD area.

**"OECD Member country"** means the countries that are members of the OECD and participate in the Amended 2001 OECD Decision. (EPA provides a list of OECD Member countries at <https://www.epa.gov/hwgenerators/international-agreements-transboundary-shipments-waste>).

**"Receiving facility"** means a U.S. facility which, under RCRA and other applicable domestic laws, is operating or is authorized to operate to receive hazardous wastes and to perform recovery or disposal operations on them.

~~**"Recognized trader"** means a person who, with appropriate authorization of countries concerned, acts in the role of principal to purchase and subsequently sell wastes; this person has legal control of such wastes from time of purchase to time of sale; such a person may act to arrange and facilitate transboundary movements of wastes destined for recovery operations.~~

~~**"Recovery facility"** means a facility which, under applicable domestic law, is operating or is authorized to operate in the country of import to receive wastes and to perform recovery operations on them.~~

**"Recovery operations"** means activities leading to resource recovery, recycling, reclamation, direct reuse or alternative uses, which include:

(1) R1 Use as a fuel (other than in direct incineration) or other means to generate energy.

(2) R2 Solvent reclamation/regeneration.

- (3) R3 Recycling/reclamation of organic substances which are not used as solvents.
- (4) R4 Recycling/reclamation of metals and metal compounds.
- (5) R5 Recycling/reclamation of other inorganic materials.
- (6) R6 Regeneration of acids or bases.
- (7) R7 Recovery of components used for pollution abatement.
- (8) R8 Recovery of components used from catalysts.
- (9) R9 Used oil re-refining or other reuses of previously used oil.
- (10) R10 Land treatment resulting in benefit to agriculture or ecological improvement.
- (11) R11 Uses of residual materials obtained from any of the operations numbered R1 ~~through~~ R10 or RC14 (for transboundary shipments with Canada only).
- (12) R12 Exchange of wastes for submission to any of the operations numbered R1 ~~through~~ R11 or RC14 (for transboundary shipments with Canada only).
- (13) R13 Accumulation of material intended for any operation numbered ~~R1–R12~~ R1 through R12 or RC14 (for transboundary shipments with Canada only).
- (14) RC14 Recovery or regeneration of a substance or use or re-use of a recyclable material, other than by any of operations R1 through R10 (for transboundary shipments with Canada only).
- (15) RC15 Testing of a new technology to recycle a hazardous recyclable material (for transboundary shipments with Canada only).
- (16) RC16 Interim storage prior to any of operations R1 through R11 or RC14 (for transboundary shipments with Canada only).

**"Transboundary movement"** any movement of hazardous wastes from an area under the national jurisdiction of one ~~OECD Member~~ country to an area under the national jurisdiction of another ~~OECD Member~~ country.

**Revise 61-79.262.82 to read:**

(a) Scope. The level of control for exports and imports of waste is indicated by assignment of the waste to either a list of wastes subject to the Green control procedures or a list of wastes subject to the Amber control procedures and ~~by the national procedures of the United States, as defined in 262.80(a) whether the waste is or is not hazardous waste.~~ The OECD Green and Amber lists are incorporated by reference in ~~262.89(d) in R.61-79.260.11.~~

(1) ~~Listed wastes subject to the Green control procedures~~ Green list wastes.

(i) ~~Green wastes that are not considered hazardous under U.S. national procedures as defined in 262.80(a)~~ wastes are subject to existing controls normally applied to commercial transactions, and are not subject to the requirements of this subpart.

(ii) ~~Green wastes that are considered hazardous under U.S. national procedures as defined in 262.80(a) wastes~~ are subject to the ~~Amber control procedures set forth in requirements of this subpart.~~

(2) ~~Listed wastes subject to the Amber control procedures~~ Amber list wastes.

(i) ~~Amber wastes that are considered hazardous under U.S. national procedures as defined in 262.80(a) wastes~~ are subject to the ~~Amber control procedures set forth in requirements of this subpart, even if they are imported to or exported from a country that does not consider the waste to be hazardous or control the transboundary shipment as a hazardous waste import or export.~~

(A) For exports, the exporter must comply with section R.61-79.262.83.

(B) For imports, the recovery or disposal facility and the importer must comply with section 262.84.

(ii) ~~Amber wastes that are not hazardous wastes, but are considered hazardous under U.S. national procedures as defined in 262.80(a), by the other country~~ are subject to the Amber control procedures in the United States, ~~even if they are imported to or exported from a designated OECD Member country listed in 262.58(a)(1) that does not consider the waste to be hazardous. In such an event, the responsibilities of the Amber control procedures shift as provided: country that considers the waste hazardous, and are not subject to the requirements of this subpart. All responsibilities of the importer or exporter shift to the foreign importer or foreign exporter in the other country that considers the waste hazardous unless the parties make other arrangements through contracts.~~

**Note to paragraph (a)(2):** ~~wastes subject to the Amber control procedures~~ Amber list wastes are not listed or otherwise identified as hazardous under RCRA, and therefore are not subject to the ~~Amber control procedures requirements~~ of this subpart. Regardless of the status of the waste under RCRA, however, other Federal environmental statutes (e.g., the Toxic Substances Control Act) restrict certain waste imports or exports. Such restrictions continue to apply with regard to this subpart.

(3) ~~Procedures for mixtures of wastes~~ Mixtures of wastes.

(i) ~~A Green waste that is mixed with one or more other Green wastes such that the resulting mixture is not considered hazardous under U.S. national procedures as defined in 262.80(a) shall be subject to the Green control procedures, provided the composition of this mixture does not impair its environmentally sound recovery~~ hazardous waste is not subject to the requirements of this subpart.

**Note to Paragraph (a)(3)(i):** ~~Regulated community should note that some OECD Member countries may require, by domestic law, that mixtures of different Green wastes be subject to the Amber control procedures.~~

(ii) ~~A Green waste that is mixed with one or more Amber wastes, in any amount, de minimis or otherwise, or a mixture of two or more Amber wastes, such that the resulting waste mixture is considered hazardous under U.S. national procedures as defined in 262.80(a) are subject to the Amber control procedures, provided the composition of this mixture does not impair its environmentally sound recovery~~ hazardous waste is subject to the requirements of this subpart.

**Note to Paragraph (a)(3)(ii):** ~~Regulated community should note that some OECD Member countries may require, by domestic law, that a mixture of a Green waste and more than a de minimis amount of an Amber waste or a mixture of two or more Amber wastes be subject to the Amber control procedures.~~



(4) Wastes not yet assigned to an OECD waste list are eligible for transboundary movements, as follows:

(i) ~~If such wastes are considered hazardous under U.S. national procedures as defined in 262.80(a) hazardous wastes, such wastes are subject to the Amber control procedures requirements of this subpart.~~

(ii) ~~If such wastes are not considered hazardous under U.S. national procedures as defined in 262.80(a) hazardous wastes, such wastes are not subject to the Green control procedures requirements of this subpart.~~

(b) General conditions applicable to transboundary movements of hazardous waste.

(1) The hazardous waste must be destined for recovery or disposal operations at a facility that, under applicable domestic law, is operating or is authorized to operate in the importing country of import;

(2) The transboundary movement must be in compliance with applicable international transport agreements; ~~and the transboundary movement must be in compliance with applicable international transport agreements; and~~

**Note to Paragraph (b)(2)** international agreements include, but are not limited to, the Chicago Convention (1944), ADR (1957), ADNR (1970), MARPOL Convention (1973/1978), SOLAS Convention (1974), IMDG Code (1985), COTIF (1985), and RID (1985).

(3) Any transit of hazardous waste through a ~~non-OECD member~~ one or more countries must be conducted in compliance with all applicable international and national laws and regulations.

(c) ~~Provisions relating to re-export for recovery to a third country.~~ Duty to return wastes subject to the Amber control procedures during transit through the United States . When a transboundary movement of hazardous wastes transiting the United States and subject to the Amber control procedures does not comply with the requirements of the notification and movement documents or otherwise constitutes illegal shipment, and if alternative arrangements cannot be made to recover or dispose of these wastes in an environmentally sound manner, the waste must be returned to the country of export. The U.S. transporter must inform EPA at the specified mailing address in paragraph (e) of this section of the need to return the shipment. EPA will then inform the competent authority of the country of export, citing the reason(s) for returning the waste. The U.S. transporter must complete the return within ninety (90) days from the time EPA informs the country of export of the need to return the waste, unless informed in writing by EPA of another timeframe agreed to by the concerned countries.

(d) ~~Duty to return or re-export wastes subject to the Amber control procedures. When a transboundary movement of wastes subject to the Amber control procedures cannot be completed in accordance with the terms of the contract or the consent(s) and alternative arrangements cannot be made to recover the waste in an environmentally sound manner in the country of import, the waste must be returned to the country of export or re-exported to a third country. The provisions of paragraph (e) of this section apply to any shipments to be re-exported to a third country. The following provisions apply to shipments to be returned to the country of export as appropriate: Laboratory analysis exemption. Export or import of a hazardous waste sample is exempt from the requirements of this subpart if the sample is destined for laboratory analysis to assess its physical or chemical characteristics, or to determine its suitability for recovery or disposal operations, does not exceed twenty-five (25) kilograms in quantity, is appropriately packaged and labeled, and complies with the conditions of R.61-79.261.4(d) or (e).~~

~~(e) Duty to return wastes subject to the Amber control procedures from a country of transit. When a transboundary movement of wastes subject to the Amber control procedures does not comply with the requirements of the notification and movement documents or otherwise constitutes illegal shipment, and if alternative arrangements cannot be made to recover these wastes in an environmentally sound manner, the waste must be returned to the country of export. The following provisions apply as appropriate: EPA Address for submittals by postal mail or hand delivery. Submittals required in this subpart to be made by postal mail or hand delivery should be sent to the following addresses:~~

~~(1) Return from the United States (as country of transit) to the country of export: The U.S. transporter must inform EPA at the specified address in 262.83(b)(1)(i) of the need to return the shipment. EPA will then inform the competent authority of the country of export, citing the reason(s) for returning the waste. The U.S. transporter must complete the return within ninety (90) days from the time EPA informs the country of export of the need to return the waste, unless informed in writing by EPA of another timeframe agreed to by the concerned Member countries. For postal mail delivery, the Office of Land and Emergency Management, Office of Resource Conservation and Recovery, Materials Recovery and Waste Management Division, International Branch (Mail Code 2255A), Environmental Protection Agency, 1200 Pennsylvania Avenue NW, Washington, DC 20460.~~

~~(2) Return from the country of transit to the United States (as country of export): The U.S. exporter must provide for the return of the hazardous waste shipment within ninety (90) days from the time the competent authority of the country of transit informs EPA of the need to return the waste or such other period of time as the concerned Member countries agree. The U.S. exporter must submit an exception report to EPA in accordance with 262.87(b). For hand delivery, the Office of Land and Emergency Management, Office of Resource Conservation and Recovery, Materials Recovery and Waste Management Division, International Branch, Environmental Protection Agency, William Jefferson Clinton South Bldg., Room 6144, 1200 Pennsylvania Ave., NW., Washington, DC 20004.”~~

**Revise 61-79.262.83 title to read:**

**262.83 Notification and consent Exports of hazardous waste.**

**Revise 61-79.262.83(a) and add items 262.83(a)(1) to 262.83(a)(6) to read:**

~~(a) Applicability General export requirements. Consent must be obtained from the competent authorities of the relevant OECD countries of import and transit prior to exporting hazardous waste destined for recovery operations subject to this subpart. Hazardous wastes subject to the Amber control procedures are subject to the requirements of paragraph (b) of this section; and wastes not identified on any list are subject to the requirements of paragraph (c) of this section. Except as provided in paragraphs (a)(5) and (6) of this section, exporters that have received an AOC from EPA before December 31, 2016, are subject to that approval and the requirements listed in the AOC that existed at the time of that approval until such time the approval period expires. All other exports of hazardous waste are prohibited unless:~~

~~\_\_\_\_\_ (1) The exporter complies with the contract requirements in paragraph (f) of this section;~~

~~\_\_\_\_\_ (2) The exporter complies with the notification requirements in paragraph (b) of this section;~~

~~\_\_\_\_\_ (3) The exporter receives an AOC from EPA documenting consent from the countries of import and transit (and original country of export if exporting previously imported hazardous waste);~~

~~\_\_\_\_\_ (4) The exporter ensures compliance with the movement documents requirements in paragraph (d) of this section;~~

(5) The exporter ensures compliance with the manifest instructions for export shipments in paragraph (c) of this section; and

(6) The exporter or a U.S. authorized agent:

(i) For shipments initiated prior to the AES filing compliance date, does one of the following:

(A) Submits Electronic Export Information (EEI) for each shipment to the Automated Export System (AES) or its successor system, under the International Trade Data System (ITDS) platform, in accordance with 15 CFR 30.4(b), and includes the following items in the EEI, along with the other information required under 15 CFR 30.6:

(1)EPA license code;

(2)Commodity classification code for each hazardous waste per 15 CFR 30.6(a)(12);

(3)EPA consent number for each hazardous waste;

(4)Country of ultimate destination code per 15 CFR 30.6(a)(5);

(5)Date of export per 15 CFR 30.6(a)(2);

(6)RCRA hazardous waste manifest tracking number, if required;

(7)Quantity of each hazardous waste in shipment and units for reported quantity, if required reporting units established by value for the reported commodity classification number are in units of weight or volume per 15 CFR 30.6(a)(15); or

(8)EPA net quantity for each hazardous waste reported in units of kilograms if solid or in units of liters if liquid, if required reporting units established by value for the reported commodity classification number are not in units of weight or volume.

(B) Complies with a paper-based process by:

(1) Attaching paper documentation of consent (i.e., a copy of the EPA Acknowledgment of Consent, international movement document) to the manifest, or shipping papers if a manifest is not required, which must accompany the hazardous waste shipment. For exports by rail or water (bulk shipment), the primary exporter must provide the transporter with the paper documentation of consent which must accompany the hazardous waste but which need not be attached to the manifest except that for exports by water (bulk shipment) the primary exporter must attach the paper documentation of consent to the shipping paper.

(2) Providing the transporter with an additional copy of the manifest, and instructing the transporter via mail, email or fax to deliver that copy to the U.S. Customs official at the point the hazardous waste leaves the United States in accordance with 40 CFR 263.20(g)(4)(ii).

(ii) For shipments initiated on or after the AES filing compliance date, submits Electronic Export Information (EEI) for each shipment to the Automated Export System (AES) or its successor system, under the International Trade Data System (ITDS) platform, in accordance with 15 CFR 30.4(b), and includes the following items in the EEI, along with the other information required under 15 CFR 30.6:

(A) EPA license code;

          (B) Commodity classification code for each hazardous waste per 15 CFR 30.6(a)(12);

          (C) EPA consent number for each hazardous waste;

          (D) Country of ultimate destination code per 15 CFR 30.6(a)(5);

          (E) Date of export per 15 CFR 30.6(a)(2);

          (F) RCRA hazardous waste manifest tracking number, if required;

          (G) Quantity of each hazardous waste in shipment and units for reported quantity, if required reporting units established by value for the reported commodity classification number are in units of weight or volume per 15 CFR 30.6(a)(15); or

          (H) EPA net quantity for each hazardous waste reported in units of kilograms if solid or in units of liters if liquid, if required reporting units established by value for the reported commodity classification number are not in units of weight or volume.

**Revis~~61-79.262.83(b)~~ add items~~262.83(b)(1)(iv)~~ ~~262.83(b)(1)(xiii)~~ remove items ~~262.83(b)(2)(i) to 262.83(b)(2)(ii)~~ to read:**

~~(b) Amber wastes. Exports of hazardous wastes from the United States as described in 262.80(a) that are subject to the Amber control procedures are prohibited unless the notification and consent requirements of paragraph (b)(1) or paragraph (b)(2) of this section are met.~~Notifications—

~~(1) Transactions requiring specific consent:~~General notifications. At least sixty (60) days before the first shipment of hazardous waste is expected to leave the United States, the exporter must provide notification in English to EPA of the proposed transboundary movement. Notifications must be submitted electronically using EPA's Waste Import Export Tracking System (WIETS), or its successor system. The notification may cover up to one (1) year of shipments of one or more hazardous wastes being sent to the same recovery or disposal facility, and must include all of the following information:

~~(i) Notification. At least forty five (45) days prior to commencement of each transboundary movement, the exporter must provide written notification in English of the proposed transboundary movement to the Office of Enforcement and Compliance Assurance, Office of Federal Activities, International Compliance Assurance Division (2254A), Environmental Protection Agency, 1200 Pennsylvania Avenue, NW., Washington, DC 20460, with the words "Attention: OECD Export Notification" prominently displayed on the envelope. This notification must include all of the information identified in paragraph (d) of this section. In cases where wastes having similar physical and chemical characteristics, the same United Nations classification, the same RCRA waste codes, and are to be sent periodically to the same recovery facility by the same exporter, the exporter may submit one general notification of intent to export these wastes in multiple shipments during a period of up to one (1) year. Even when a general notification is used for multiple shipments, each shipment still must be accompanied by its own movement document pursuant to 262.84.~~Exporter name and EPA identification number, address, telephone and fax numbers, and e-mail address;

~~(ii) Tacit consent. If no objection has been lodged by any countries concerned (i.e., exporting, importing, or transit) to a notification provided pursuant to paragraph (b)(1)(i) of this section within thirty~~

~~(30) days after the date of issuance of the Acknowledgement of Receipt of notification by the competent authority of the country of import, the transboundary movement may commence. Tacit consent expires one (1) calendar year after the close of the thirty (30) day period; renotification and renewal of all consents is required for exports after that date. Foreign receiving facility name, address, telephone and fax numbers, e-mail address, technologies employed, and the applicable recovery or disposal operations as defined in R.61-79.262.81;~~

~~(iii) Written consent. If the competent authorities of all the relevant OECD importing and transit countries provide written consent in a period less than thirty (30) days, the transboundary movement may commence immediately after all necessary consents are received. Written consent expires for each relevant OECD importing and transit country one (1) calendar year after the date of that country's consent unless otherwise specified; renotification and renewal of each expired consent is required for exports after that date. Foreign importer name (if not the owner or operator of the foreign receiving facility), address, telephone and fax numbers, and e-mail address;~~

~~(iv) Intended transporter(s) and/or their agent(s); address, telephone and fax numbers, and e-mail address;~~

~~(v) "U.S." as the country of export name, "USA01" as the relevant competent authority code, and the intended U.S. port(s) of exit;~~

~~(vi) The ISO standard 3166 country name 2-digit code, OECD/Basel competent authority code, and the ports of entry and exit for each country of transit;~~

~~(vii) The ISO standard 3166 country name 2-digit code, OECD/Basel competent authority code, and port of entry for the country of import;~~

~~(viii) Statement of whether the notification covers a single shipment or multiple shipments;~~

~~(ix) Start and End Dates requested for transboundary movements;~~

~~(x) Means of transport planned to be used;~~

~~(xi) Description(s) of each hazardous waste, including whether each hazardous waste is regulated universal waste under 40 CFR part 273, or the state equivalent, spent lead-acid batteries being exported for recovery of lead under 40 CFR part 266, subpart G, or the state equivalent, or industrial ethyl alcohol being exported for reclamation under 40 CFR 261.6(a)(3)(i), or the state equivalent, estimated total quantity of each waste in either metric tons or cubic meters, the applicable RCRA waste code(s) for each hazardous waste, the applicable OECD waste code from the lists incorporated by reference in 40 CFR 260.11, and the United Nations/U.S. Department of Transportation (DOT) ID number for each waste;~~

~~(xii) Specification of the recovery or disposal operation(s) as defined in section 262.81.~~

~~(xiii) Certification/Declaration signed by the exporter that states:~~

~~I certify that the above information is complete and correct to the best of my knowledge. I also certify that legally enforceable written contractual obligations have been entered into and that any applicable insurance or other financial guarantee is or shall be in force covering the transboundary movement.~~

Name: \_\_\_\_\_

Signature: \_\_\_\_\_

Date: \_\_\_\_\_

~~(2) Transboundary movements to facilities pre-approved by the competent authorities of the importing countries to accept specific wastes for recovery. Exports to pre-consented recovery facilities in OECD Member countries. If the recovery facility is located in an OECD Member country and has been pre-consented by the competent authority of the OECD Member country to recover the waste sent by exporters located in other OECD Member countries, the notification may cover up to three (3) years of shipments. Notifications proposing export to a pre-consented facility in an OECD Member country must include all information listed in paragraphs (b)(1)(i) through (b)(1)(xiii) of this section and additionally state that the facility is pre-consented. Exporters must submit the notification to EPA using the allowable methods listed in paragraph (b)(1) of this section at least ten (10) days before the first shipment is expected to leave the United States.~~

~~(i) Notification. The exporter must provide EPA a notification that contains all the information identified in paragraph (d) of this section in English, at least ten (10) days in advance of commencing shipment to a pre-approved facility. The notification must indicate that the recovery facility is pre-approved, and may apply to a single specific shipment or to multiple shipments as described in paragraph (b)(1)(i) of this section. This information must be sent to the Office of Enforcement and Compliance Assurance, Office of Federal Activities, International Compliance Assurance Division (2254A), Environmental Protection Agency, 1200 Pennsylvania Avenue, NW., Washington, DC 20460, with the words "OECD Export Notification Pre approved Facility" prominently displayed on the envelope. General notifications that cover multiple shipments as described in paragraph (b)(1)(i) of this section may cover a period of up to three (3) years. Even when a general notification is used for multiple shipments, each shipment still must be accompanied by its own movement document pursuant to 262.84.~~

~~(ii) Exports to pre-approved facilities may take place after the elapse of seven (7) working days from the issuance of an Acknowledgement of Receipt of the notification by the competent authority of the country of import unless the exporter has received information indicating that the competent authority of any countries concerned objects to the shipment.~~

**Revise 61-79.262.83(b) to add items 262.83(b)(3) to 262.83(b)(8) to read:**

~~(3) Notifications listing interim recycling operations or interim disposal operations. If the foreign receiving facility listed in paragraph (b)(1)(ii) of this section will engage in any of the interim recovery operations R12 or R13 or interim disposal operations D13 through D15, or in the case of transboundary movements with Canada, any of the interim recovery operations R12, R13, or RC16, or interim disposal operations D13 to D14, or DC17, the notification submitted according to paragraph (b)(1) of this section must also include the final foreign recovery or disposal facility name, address, telephone and fax numbers, e-mail address, technologies employed, and which of the applicable recovery or disposal operations R1 through R11 and D1 through D12, or in the case of transboundary movements with Canada, which of the applicable recovery or disposal operations R1 through R11, RC14 to RC15, D1 through D12, and DC15 to DC16 will be employed at the final foreign recovery or disposal facility. The recovery and disposal operations in this paragraph are defined in R.61-79.262.81.~~

~~(4) Renotifications. When the exporter wishes to change any of the information specified on the original notification (including increasing the estimate of the total quantity of hazardous waste specified in the original notification or adding transporters), the exporter must submit a renotification of the changes to EPA using the allowable methods in paragraph (b)(1) of this section. Any shipment using the requested changes cannot take place until the countries of import and transit consent to the changes and the exporter receives an EPA AOC letter documenting the countries' consents to the changes.~~

(5) For cases where the proposed country of import and recovery or disposal operations are not covered under an international agreement to which both the United States and the country of import are parties, EPA will coordinate with the Department of State to provide the complete notification to the country of import and any countries of transit. In all other cases, EPA will provide the notification directly to the country of import and any countries of transit. A notification is complete when EPA receives a notification which EPA determines satisfies the requirements of paragraph (b)(1)(i) through (b)(1)(xiii) of this section.

(6) Where the countries of import and transit consent to the proposed transboundary movement(s) of the hazardous waste(s), EPA will forward an EPA AOC letter to the exporter documenting the countries' consents. Where any of the countries of import and transit objects to the proposed transboundary movement(s) of the hazardous waste or withdraws a prior consent, EPA will notify the exporter.

(7) Export of hazardous wastes for recycling or disposal operations that were originally imported into the United States for recycling or disposal operations in a third country is prohibited unless an exporter in the United States complies with the export requirements in ~~section R.61-79.262.83~~, including providing notification to EPA in accordance with paragraph (b)(1) of this section. In addition to listing all required information in paragraphs (b)(1)(i) through (b)(1)(xiii) of this section, the exporter must provide the original consent number issued for the initial import of the wastes in the notification, and receive an AOC from EPA documenting the consent of the competent authorities in the new country of import, the original country of export, and any transit countries prior to re-export.

(8) Upon request by EPA, the exporter must furnish to EPA any additional information which the country of import requests in order to respond to a notification.

**Revise 61-79.262.83(c) and add items 262.83(c)(1) to 262.83(c)(4) to read:**

(c) ~~Wastes not covered in the OECD Green and Amber lists. Wastes destined for recovery operations, that have not been assigned to the OECD Green and Amber lists, incorporated by reference in 262.89(d), but which are considered hazardous under U.S. national procedures as defined in 262.80(a), are subject to the notification and consent requirements established for the Amber control procedures in accordance with paragraph (b) of this section. Wastes destined for recovery operations, that have not been assigned to the OECD Green and Amber lists incorporated by reference in 262.89(d), and are not considered hazardous under U.S. national procedures as defined by 262.80(a) are subject to the Green control procedures.~~ RCRA manifest instructions for export shipments. The exporter must comply with the manifest requirements of ~~sections R.61-79.262.20 through 262.23~~ except that:

(1) In lieu of the name, site address and EPA identification number of the designated permitted facility, the exporter must enter the name and site address of the foreign receiving facility;

(2) In the International Shipments block, the exporter must check the export box and enter the U.S. port of exit (city and state) from the United States.

(3) The exporter must list the consent number from the AOC for each hazardous waste listed on the manifest, matched to the relevant list number for the hazardous waste from block 9b. If additional space is needed, the exporter should use a Continuation Sheet(s) (EPA Form 8700-22A).

(4) The exporter may obtain the manifest from any source that is registered with the U.S. EPA as a supplier of manifests (e.g., states, waste handlers, and/or commercial forms printers).

**Revise 61-79.262.83(d) and add items 262.83(d)(1)(i) to 262.83(d)(2)(xv) and renumber through (14) to read:**

~~(d) Notifications submitted under this section must include the information specified in paragraphs (d)(1) through (d)(14) of this section: Movement document requirements for export shipments.~~

~~(1) Serial number or other accepted identifier of the notification document; All exporters must ensure that a movement document meeting the conditions of paragraph (d)(2) of this section accompanies each transboundary movement of hazardous wastes from the initiation of the shipment until it reaches the foreign receiving facility, including cases in which the hazardous waste is stored and/or sorted by the foreign importer prior to shipment to the foreign receiving facility, except as provided in paragraphs (d)(1)(i) and (ii) of this section.~~

~~(i) For shipments of hazardous waste within the United States solely by water (bulk shipments only), the exporter must forward the movement document to the last water (bulk shipment) transporter to handle the hazardous waste in the United States if exported by water.~~

~~(ii) For rail shipments of hazardous waste within the United States which start from the company originating the export shipment, the exporter must forward the movement document to the next non-rail transporter, if any, or the last rail transporter to handle the hazardous waste in the United States if exported by rail.~~

~~(2) Exporter name and EPA identification number (if applicable), address, telephone, fax numbers, and e-mail address; The movement document must include the following paragraphs (d)(2)(i) through (xv) of this section:~~

~~(i) The corresponding consent number(s) and hazardous waste number(s) for the listed hazardous waste from the relevant EPA AOC(s);~~

~~(ii) The shipment number and the total number of shipments from the EPA AOC;~~

~~(iii) Exporter name and EPA identification number, address, telephone and fax numbers, and e-mail address;~~

~~(iv) Foreign receiving facility name, address, telephone and fax numbers, e-mail address, technologies employed, and the applicable recovery or disposal operations as defined in section R.61-79.262.81;~~

~~(v) Foreign importer name (if not the owner or operator of the foreign receiving facility), address, telephone and fax numbers, and e-mail address;~~

~~(vi) Description(s) of each hazardous waste, quantity of each hazardous waste in the shipment, applicable RCRA hazardous waste code(s) for each hazardous waste, applicable OECD waste code for each hazardous waste from the lists incorporated by reference in 40 CFR 260.11, and the United Nations/U.S. Department of Transportation (DOT) ID number for each hazardous waste;~~

~~(vii) Date movement commenced;~~

~~(viii) Name (if not exporter), address, telephone and fax numbers, and e-mail address of company originating the shipment;~~



(ix) Company name, EPA identification number, address, telephone and fax numbers, and e-mail address of all transporters;

(x) Identification (license, registered name or registration number) of means of transport, including types of packaging;

(xi) Any special precautions to be taken by transporter(s);

(xii) Certification/declaration signed and dated by the exporter that the information in the movement document is complete and correct;

(xiii) Appropriate signatures for each custody transfer (e.g., transporter, importer, and owner or operator of the foreign receiving facility);

(xiv) Each U.S. person that has physical custody of the hazardous waste from the time the movement commences until it arrives at the foreign receiving facility must sign the movement document (e.g., transporter, foreign importer, and owner or operator of the foreign receiving facility); and

(xv) As part of the contract requirements per paragraph (f) of this section, the exporter must require that the foreign receiving facility send a copy of the signed movement document to confirm receipt within three working days of shipment delivery to the exporter, to the competent authorities of the countries of import and transit, and for shipments occurring on or after the electronic import-export reporting compliance date, the exporter must additionally require that the foreign receiving facility send a copy to the EPA at the same time using the allowable methods listed in paragraph (b)(1) of this section.

~~— (3) Importing recovery facility name, address, telephone, fax numbers, e-mail address, and technologies employed;~~

~~— (4) Importer name (if not the owner or operator of the recovery facility), address, telephone, fax numbers, and e-mail address; whether the importer will engage in waste exchange recovery operation R12 or waste accumulation recovery operation R13 prior to delivering the waste to the final recovery facility— and identification of recovery operations to be employed at the final recovery facility;~~

~~— (5) Intended transporter(s) and/or their agent(s); address, telephone, fax, and e-mail address;~~

~~— (6) Country of export and relevant competent authority, and point of departure;~~

~~— (7) Countries of transit and relevant competent authorities and points of entry and departure;~~

~~— (8) Country of import and relevant competent authority, and point of entry;~~

~~— (9) Statement of whether the notification is a single notification or a general notification. If general, include period of validity requested;~~

~~— (10) Date(s) foreseen for commencement of transboundary movement(s);~~

~~— (11) Means of transport envisaged;~~

~~— (12) Designation of waste type(s) from the appropriate OECD list incorporated by reference in 262.89(d), description(s) of each waste type, estimated total quantity of each, RCRA waste code, and the United Nations number for each waste type;~~

— (13) Specification of the recovery operation(s) as defined in 262.81.

— (14) Certification/Declaration signed by the exporter that states:

I certify that the above information is complete and correct to the best of my knowledge. I also certify that legally enforceable written contractual obligations have been entered into, and that any applicable insurance or other financial guarantees are or shall be in force covering the transboundary movement.

Name: \_\_\_\_\_

Signature: \_\_\_\_\_

Date: \_\_\_\_\_

**Note to Paragraph (d)(14)** The United States does not currently require financial assurance for these waste shipments. However, U.S. exporters may be asked by other governments to provide and certify to such assurance as a condition of obtaining consent to a proposed movement.

### **Revise 61-79.262.83(e) to read:**

(e) Certificate of Recovery. As soon as possible, but no later than thirty (30) days after the completion of recovery and no later than one (1) calendar year following receipt of the waste, the U.S. recovery facility shall send a certificate of recovery to the exporter and to the competent authorities of the countries of export and import by mail, e-mail without a digital signature followed by mail, or fax followed by mail. The certificate of recovery shall include a signed, written and dated statement that affirms that the waste materials were recovered in the manner agreed to by the parties to the contract required under 262.85. Duty to return or re-export hazardous waste. When a transboundary movement of hazardous wastes cannot be completed in accordance with the terms of the contract or the consent(s) and alternative arrangements cannot be made to recover or dispose of the waste in an environmentally sound manner in the country of import, the exporter must ensure that the hazardous waste is returned to the United States or re-exported to a third country. If the waste must be returned, the exporter must provide for the return of the hazardous waste shipment within ninety (90) days from the time the country of import informs EPA of the need to return the waste or such other period of time as the concerned countries agree. In all cases, the exporter must submit an exception report to EPA in accordance with paragraph (h) of this section.

### **Revise 61-79.262.83 to add subsections 262.83(f), 262.83(g), 262.83(h), and 262.83(i)**

(f) Export contract requirements.

(1) Exports of hazardous waste are prohibited unless they occur under the terms of a valid written contract, chain of contracts, or equivalent arrangements (when the movement occurs between parties controlled by the same corporate or legal entity). Such contracts or equivalent arrangements must be executed by the exporter, foreign importer (if different from the foreign receiving facility), and the owner or operator of the foreign receiving facility, and must specify responsibilities for each. Contracts or equivalent arrangements are valid for the purposes of this section only if persons assuming obligations under the contracts or equivalent arrangements have appropriate legal status to conduct the operations specified in the contract or equivalent arrangements.

(2) Contracts or equivalent arrangements must specify the name and EPA identification number, where available, of paragraph (f)(2)(i) through (iv) of this section:

(i) The company from where each export shipment of hazardous waste is initiated;

(ii) Each person who will have physical custody of the hazardous wastes;

\_\_\_\_\_ (iii) Each person who will have legal control of the hazardous wastes; and

\_\_\_\_\_ (iv) The foreign receiving facility.

\_\_\_\_\_ (3) Contracts or equivalent arrangements must specify which party to the contract will assume responsibility for alternate management of the hazardous wastes if their disposition cannot be carried out as described in the notification of intent to export. In such cases, contracts must specify that:

\_\_\_\_\_ (i) The transporter or foreign receiving facility having actual possession or physical control over the hazardous wastes will immediately inform the exporter, EPA, and either the competent authority of the country of transit or the competent authority of the country of import of the need to make alternate management arrangements; and

\_\_\_\_\_ (ii) The person specified in the contract will assume responsibility for the adequate management of the hazardous wastes in compliance with applicable laws and regulations including, if necessary, arranging the return of hazardous wastes and, as the case may be, shall provide the notification for re-export to the competent authority in the country of import and include the equivalent of the information required in paragraph (b)(1) of this section, the original consent number issued for the initial export of the hazardous wastes in the notification, and obtain consent from EPA and the competent authorities in the new country of import and any transit countries prior to re-export.

\_\_\_\_\_ (4) Contracts must specify that the foreign receiving facility send a copy of the signed movement document to confirm receipt within three (3) working days of shipment delivery to the exporter and to the competent authorities of the countries of import and transit. For contracts that will be in effect on or after the electronic import-export reporting compliance date, the contracts must additionally specify that the foreign receiving facility send a copy to EPA at the same time using the allowable methods listed in paragraph (b)(1) of this section on or after that date.

\_\_\_\_\_ (5) Contracts must specify that the foreign receiving facility shall send a copy of the signed and dated confirmation of recovery or disposal, as soon as possible, but no later than thirty (30) days after completing recovery or disposal on the waste in the shipment and no later than one (1) calendar year following receipt of the waste, to the exporter and to the competent authority of the country of import. For contracts that will be in effect on or after the electronic import-export reporting compliance date, the contracts must additionally specify that the foreign receiving facility send a copy to EPA at the same time using the allowable methods listed in paragraph (b)(1) of this section on or after that date.

\_\_\_\_\_ (6) Contracts must specify that the foreign importer or the foreign receiving facility that performed interim recycling operations R12, R13, or RC16, or interim disposal operations D13 through D15 or DC17, (recovery and disposal operations defined in 40 CFR 262.81), as appropriate, will:

\_\_\_\_\_ (i) Provide the notification required in paragraph (f)(3)(ii) of this section prior to any re-export of the hazardous wastes to a final foreign recovery or disposal facility in a third country; and

\_\_\_\_\_ (ii) Promptly send copies of the confirmation of recovery or disposal that it receives from the final foreign recovery or disposal facility within one (1) year of shipment delivery to the final foreign recovery or disposal facility that performed one of recovery operations R1 through R11, or RC16, or one of disposal operations D1 through D12, DC15, or DC16 to the competent authority of the country of import. For contracts that will be in effect on or after the electronic import-export reporting compliance date, the contracts must additionally specify that the foreign facility send copies to EPA at the same time using the allowable method listed in paragraph (b)(1) of this section on or after that date.

(7) Contracts or equivalent arrangements must include provisions for financial guarantees, if required by the competent authorities of the country of import and any countries of transit, in accordance with applicable national or international law requirements.

**Note to Paragraph (f)(7):** Financial guarantees so required are intended to provide for alternate recycling, disposal or other means of sound management of the wastes in cases where arrangements for the shipment and the recovery operations cannot be carried out as foreseen. The United States does not require such financial guarantees at this time; however, some OECD Member countries and other foreign countries do. It is the responsibility of the exporter to ascertain and comply with such requirements; in some cases, persons or facilities located in those OECD Member countries or other foreign countries may refuse to enter into the necessary contracts absent specific references or certifications to financial guarantees.

(8) Contracts or equivalent arrangements must contain provisions requiring each contracting party to comply with all applicable requirements of this subpart.

(9) Upon request by EPA, U.S. exporters, importers, or recovery facilities must submit to EPA copies of contracts, chain of contracts, or equivalent arrangements (when the movement occurs between parties controlled by the same corporate or legal entity).

(g) Annual reports. The exporter shall file an annual report with EPA no later than March 1 of each year summarizing the types, quantities, frequency, and ultimate destination of all such hazardous waste exported during the previous calendar year. Prior to one (1) year after the AES filing compliance date, the exporter must mail or hand-deliver annual reports to EPA using one of the addresses specified in section 262.82(e), or submit to EPA using the allowable methods specified in paragraph (b)(1) of this section if the exporter has electronically filed EPA information in AES, or its successor system, per paragraph (a)(6)(i)(A) of this section for all shipments made the previous calendar year. Subsequently, the exporter must submit annual reports to EPA using the allowable methods specified in paragraph (b)(1) of this section. The annual report must include all of the following paragraphs (g)(1) through (6) of this section specified as follows:

(1) The EPA identification number, name, and mailing and site address of the exporter filing the report;

(2) The calendar year covered by the report;

(3) The name and site address of each foreign receiving facility;

(4) By foreign receiving facility, for each hazardous waste exported:

(i) A description of the hazardous waste;

(ii) The applicable EPA hazardous waste code(s) (from R.61-79.261 subpart C or D) for each waste;

(iii) The applicable waste code from the appropriate OECD waste list incorporated by reference in 40 CFR 260.11;

(iv) The applicable DOT ID number;

(v) The name and U.S. EPA identification number (where applicable) for each transporter used over the calendar year covered by the report; and

(vi) The consent number(s) under which the hazardous waste was shipped, and for each consent number, the total amount of the hazardous waste and the number of shipments exported during the calendar year covered by the report;

(5) In even numbered years, for each hazardous waste exported, except for hazardous waste produced by exporters of greater than one hundred (100) kilograms but less than one thousand (1,000) kilograms in a calendar month, and except for hazardous waste for which information was already provided pursuant to R.61-79.262.41:

(i) A description of the efforts undertaken during the year to reduce the volume and toxicity of the waste generated; and

(ii) A description of the changes in volume and toxicity of the waste actually achieved during the year in comparison to previous years to the extent such information is available for years prior to 1984; and

(6) A certification signed by the exporter that states:

I certify under penalty of law that I have personally examined and am familiar with the information submitted in this and all attached documents, and that based on my inquiry of those individuals immediately responsible for obtaining the information, I believe that the submitted information is true, accurate, and complete. I am aware that there are significant penalties for submitting false information including the possibility of fine and imprisonment.

(h) Exception reports.

(1) The exporter must file an exception report in lieu of the requirements of section 262.42 (if applicable) with EPA if any of the following occurs:

(i) The exporter has not received a copy of the RCRA hazardous waste manifest (if applicable) signed by the transporter identifying the point of departure of the hazardous waste from the United States, within forty-five (45) days from the date it was accepted by the initial transporter, in which case the exporter must file the exception report within the next thirty (30) days;

(ii) The exporter has not received a written confirmation of receipt from the foreign receiving facility in accordance with paragraph (d) of this section within ninety (90) days from the date the waste was accepted by the initial transporter in which case the exporter must file the exception report within the next thirty (30) days; or

(iii) The foreign receiving facility notifies the exporter, or the country of import notifies EPA, of the need to return the shipment to the U.S. or arrange alternate management, in which case the exporter must file the exception report within thirty (30) days of notification, or one (1) day prior to the date the return shipment commences, whichever is sooner.

(2) Prior to the electronic import-export reporting compliance date, exception reports must be mailed or hand delivered to EPA using the addresses listed in R.61-79.262.82(e). Subsequently, exception reports must be submitted to EPA using the allowable methods listed in paragraph (b)(1) of this section.

(i) Recordkeeping.

(1) The exporter shall keep the following records in paragraphs (i)(1)(i) through (v) of this section and provide them to EPA or authorized state personnel upon request:

(i) A copy of each notification of intent to export and each EPA AOC for a period of at least three (3) years from the date the hazardous waste was accepted by the initial transporter;

(ii) A copy of each annual report for a period of at least three (3) years from the due date of the report;

(iii) A copy of any exception reports and a copy of each confirmation of receipt (i.e., movement document) sent by the foreign receiving facility to the exporter for at least three (3) years from the date the hazardous waste was accepted by the initial transporter; and

(iv) A copy of each confirmation of recovery or disposal sent by the foreign receiving facility to the exporter for at least three (3) years from the date that the foreign receiving facility completed interim or final processing of the hazardous waste shipment.

(v) A copy of each contract or equivalent arrangement established per section 262.85 for at least three (3) years from the expiration date of the contract or equivalent arrangement.

(2) Exporters may satisfy these recordkeeping requirements by retaining electronically submitted documents in the exporter's account on EPA's Waste Import Export Tracking System (WIETS), or its successor system, provided that copies are readily available for viewing and production if requested by any EPA or authorized state inspector. No exporter may be held liable for the inability to produce such documents for inspection under this section if the exporter can demonstrate that the inability to produce the document is due exclusively to technical difficulty with WIETS, or its successor system, for which the exporter bears no responsibility.

(3) The periods of retention referred to in this section are extended automatically during the course of any unresolved enforcement action regarding the regulated activity or as requested by the Department.

**Revise 61-79.262.84 title to read:**

**262.84 Movement document Imports of hazardous waste.**

**Revise 61-79.262.84(a) and add items 262.84(a)(3) to 262.84(a)(5) read:**

(a) All U.S. parties subject to the contract provisions of 262.85 must ensure that a movement document meeting the conditions of paragraph (b) of this section accompanies each transboundary movement of wastes subject to the Amber control procedures from the initiation of the shipment until it reaches the final recovery facility, including cases in which the waste is stored and/or sorted by the importer prior to shipment to the final recovery facility, except as provided in paragraphs (a)(1) and (2) of this section. General import requirements.

(1) For shipments of hazardous waste within the United States solely by water (bulk shipments only), the generator must forward the movement document with the manifest to the last water (bulk shipment) transporter to handle the waste in the United States if exported by water, (in accordance with the manifest routing procedures at 262.23(e)). With the exception of paragraph (a)(5) of this section, importers of shipments covered under a consent from EPA to the country of export issued before December 31, 2016, are subject to that approval and the requirements that existed at the time of that approval until such time the approval period expires. Otherwise, any other person who imports hazardous waste from a foreign country into the United States must comply with the requirements of this part and the special requirements of this subpart.

(2) For rail shipments of hazardous waste within the United States which originate at the site of generation, the generator must forward the movement document with the manifest (in accordance with the routing procedures for the manifest in 262.23(d)) to the next non-rail transporter, if any, or the last rail transporter to handle the waste in the United States if exported by rail. In cases where the country of export does not require the foreign exporter to submit a notification and obtain consent to the export prior to shipment, the importer must submit a notification to EPA in accordance with paragraph (b) of this section.

(3) The importer must comply with the contract requirements in paragraph (f) of this section.

(4) The importer must ensure compliance with the movement documents requirements in paragraph (d) of this section; and

(5) The importer must ensure compliance with the manifest instructions for import shipments in paragraph (c) of this section.

**Revise 61-79.262.84(b) to read:**

(b) The movement document must include all information required under 262.83 (for notification), as well as the following paragraphs (b)(1) through (b)(7) of this section. Notifications. In cases where the competent authority of the country of export does not regulate the waste as hazardous waste and, thus, does not require the foreign exporter to submit to it a notification proposing export and obtain consent from EPA and the competent authorities for the countries of transit, but EPA does regulate the waste as hazardous waste:

**Revise 61-79.262.84(b)(1) and add items 262.84(b)(1)(i) to 262.84(b)(1)(xiii) to read:**

(1) ~~Date movement commenced;~~ The importer is required to provide notification in English to EPA of the proposed transboundary movement of hazardous waste at least sixty (60) days before the first shipment is expected to depart the country of export. Notifications submitted prior to the electronic import-export reporting compliance date must be mailed or hand delivered to EPA at the addresses specified in section 262.82(e). Notifications submitted on or after the electronic import-export reporting compliance date must be submitted electronically using EPA's Waste Import Export Tracking System (WIETS), or its successor system. The notification may cover up to one (1) year of shipments of one (1) or more hazardous wastes being sent from the same foreign exporter, and must include all of the following information:

(i) Foreign exporter name, address, telephone and fax numbers, and e-mail address;

(ii) Receiving facility name, EPA identification number, address, telephone and fax numbers, e-mail address, technologies employed, and the applicable recovery or disposal operations as defined in section 262.81;

(iii) Importer name (if not the owner or operator of the receiving facility), EPA identification number, address, telephone and fax numbers, and e-mail address;

(iv) Intended transporter(s) and/or their agent(s); address, telephone and fax numbers, and e-mail address;

(v) "U.S." as the country of import, "USA01" as the relevant competent authority code, and the intended U.S. port(s) of entry;

\_\_\_\_\_ (vi) The ISO standard 3166 country name 2-digit code, OECD/Basel competent authority code, and the ports of entry and exit for each country of transit;

\_\_\_\_\_ (vii) The ISO standard 3166 country name 2-digit code, OECD/Basel competent authority code, and port of exit for the country of export;

\_\_\_\_\_ (viii) Statement of whether the notification covers a single shipment or multiple shipments;

\_\_\_\_\_ (ix) Start and End Dates requested for transboundary movements;

\_\_\_\_\_ (x) Means of transport planned to be used;

\_\_\_\_\_ (xi) Description(s) of each hazardous waste, including whether each hazardous waste is regulated universal waste under 40 CFR part 273, or the state equivalent, spent lead-acid batteries being exported for recovery of lead under 40 CFR part 266, subpart G, or the state equivalent, or industrial ethyl alcohol being exported for reclamation under 40 CFR 261.6(a)(3)(i), or the state equivalent, estimated total quantity of each hazardous waste, the applicable RCRA hazardous waste(s) for each hazardous waste, the applicable OECD waste code from the lists incorporated by reference in 40 CFR 260.11, and the United Nations/U.S. Department of Transportation (DOT) ID number for each hazardous waste;

\_\_\_\_\_ (xii) Specification of the recovery or disposal operation(s) as defined in section 262.81; and

\_\_\_\_\_ (xiii) Certification/Declaration signed by the importer that states:

I certify that the above information is complete and correct to the best of my knowledge. I also certify that legally enforceable written contractual obligations have been entered into and that any applicable insurance or other financial guarantee is or shall be in force covering the transboundary movement.

Name:

Signature:

Date:

**Note to Paragraph (b)(1)(iii):** United States does not currently require financial assurance for these waste shipments.

**Revise 61-79.262.84(b)(2) to 262.84(b)(6) and remove 262.84(b)(7) to read:**

(2) ~~Name (if not exporter), address, telephone, fax numbers, and e-mail of primary exporter;~~ Notifications listing interim recycling operations or interim disposal operations. If the receiving facility listed in paragraph (b)(1)(ii) of this section will engage in any of the interim recovery operations R12 or R13 or interim disposal operations D13 through D15, the notification submitted according to paragraph (b)(1) of this section must also include the final recovery or disposal facility name, address, telephone and fax numbers, e-mail address, technologies employed, and which of the applicable recovery or disposal operations R1 through R11 and D1 through D12, will be employed at the final recovery or disposal facility. The recovery and disposal operations in this paragraph are defined in ~~61-79.262.81.~~

(3) ~~Company name and EPA ID number of all transporters;~~ Renotifications. When the foreign exporter wishes to change any of the conditions specified on the original notification (including increasing the estimate of the total quantity of hazardous waste specified in the original notification or adding transporters), the importer must submit a renotification of the changes to EPA using the allowable methods in paragraph (b)(1) of this section. Any shipment using the requested changes cannot take place until EPA



and the countries of transit consent to the changes and the importer receives an EPA AOC letter documenting the consents to the changes.

~~(4) Identification (license, registered name or registration number) of means of transport, including types of packaging envisaged; A notification is complete when EPA determines the notification satisfies the requirements of paragraph (b)(1)(i) through (xiii) of this section.~~

~~(5) Any special precautions to be taken by transporter(s); Where EPA and the countries of transit consent to the proposed transboundary movement(s) of the hazardous waste(s), EPA will forward an EPA AOC letter to the importer documenting the countries' consents and EPA's consent. Where any of the countries of transit or EPA objects to the proposed transboundary movement(s) of the hazardous waste or withdraws a prior consent, EPA will notify the importer.~~

~~(6) Certification/declaration signed by the exporter that no objection to the shipment has been lodged, as follows:~~

~~I certify that the above information is complete and correct to the best of my knowledge. I also certify that legally enforceable written contractual obligations have been entered into, that any applicable insurance or other financial guarantees are or shall be in force covering the transboundary movement, and that:~~

~~1. All necessary consents have been received; OR~~

~~2. The shipment is directed to a recovery facility within the OECD area and no objection has been received from any of the countries concerned within the thirty (30) day tacit consent period; OR~~

~~3. The shipment is directed to a recovery facility pre-approved for that type of waste within the OECD area; such an authorization has not been revoked, and no objection has been received from any of the countries concerned (Delete sentences that are not applicable)~~

Name: Signature: Date: Export of hazardous wastes originally imported into the United States. Export of hazardous wastes that were originally imported into the United States for recycling or disposal operations is prohibited unless an exporter in the United States complies with the export requirements in section 262.83(b)(7).

~~— (7) Appropriate signatures for each custody transfer (e.g., transporter, importer, and owner or operator of the recovery facility).~~

**Revise 61-79.262.84(c) and add items 262.84(c)(1) to 262.84(c)(5) to read:**

~~(c) Exporters also must comply with the special manifest requirements of 262.54(a), (b), (c), (e), and (i) and importers must comply with the import requirements of 262, subpart FRCRA Manifest instructions for import shipments.~~

(1) When importing hazardous waste, the importer must meet all the requirements of section 262.20 for the manifest except that:

(i) In place of the generator's name, address and EPA identification number, the name and address of the foreign generator and the importer's name, address and EPA identification number must be used.

(ii) In place of the generator's signature on the certification statement, the importer or his agent must sign and date the certification and obtain the signature of the initial transporter.

(2) The importer may obtain the manifest form from any source that is registered with the EPA as a supplier of manifests (e.g., states, waste handlers, and/or commercial forms printers).

(3) In the International Shipments block, the importer must check the import box and enter the point of entry (city and state) into the United States.

(4) The importer must provide the transporter with an additional copy of the manifest to be submitted by the receiving facility to U.S. EPA in accordance with R.61-79.264.71(a)(3) and 265.71(a)(3).

(5) In lieu of the requirements of ~~section~~ R.61-79.262.20(d), where a shipment cannot be delivered for any reason to the receiving facility, the importer must instruct the transporter in writing via fax, e-mail or mail to:

(i) Return the hazardous waste to the foreign exporter or designate another facility within the United States; and

(ii) Revise the manifest in accordance with the importer's instructions.

**Revise 61-79.262.84(d) and add items 262.84(d)(1) and 262.84(d)(2) to read:**

(d) Each U.S. person that has physical custody of the waste from the time the movement commences — until it arrives at the recovery facility must sign the movement document (e.g., transporter, importer, and ~~owner or operator of the recovery facility~~) Movement document requirements for import shipments.

(1) The importer must ensure that a movement document meeting the conditions of paragraph (d)(2) of this section accompanies each transboundary movement of hazardous wastes from the initiation of the shipment in the country of export until it reaches the receiving facility, including cases in which the hazardous waste is stored and/or sorted by the importer prior to shipment to the receiving facility, except as provided in paragraphs (d)(1)(i) and (ii) of this section.

(i) For shipments of hazardous waste within the United States by water (bulk shipments only), the importer must forward the movement document to the last water (bulk shipment) transporter to handle the hazardous waste in the United States if imported by water.

(ii) For rail shipments of hazardous waste within the United States which start from the company originating the export shipment, the importer must forward the movement document to the next non-rail transporter, if any, or the last rail transporter to handle the hazardous waste in the United States if imported by rail.

(2) The movement document must include the following paragraphs (d)(2)(i) through (xv) of this section:

(i) The corresponding AOC number(s) and waste number(s) for the listed waste;

(ii) The shipment number and the total number of shipments under the AOC number;

(iii) Foreign exporter name, address, telephone and fax numbers, and e-mail address;

(iv) Receiving facility name, EPA identification number, address, telephone and fax numbers, e-mail address, technologies employed, and the applicable recovery or disposal operations as defined in section 262.81;

(v) Importer name (if not the owner or operator of the receiving facility), EPA identification number, address, telephone and fax numbers, and e-mail address;

(vi) Description(s) of each hazardous waste, quantity of each hazardous waste in the shipment, applicable RCRA hazardous waste code(s) for each hazardous waste, the applicable OECD waste code for each hazardous waste from the lists incorporated by reference in 40 CFR 260.11, and the United Nations/U.S. Department of Transportation (DOT) ID number for each hazardous waste;

(vii) Date movement commenced;

(viii) Name (if not the foreign exporter), address, telephone and fax numbers, and e-mail of the foreign company originating the shipment;

(ix) Company name, EPA identification number, address, telephone and fax numbers, and e-mail address of all transporters;

(x) Identification (license, registered name or registration number) of means of transport, including types of packaging;

(xi) Any special precautions to be taken by transporter(s);

(xii) Certification/declaration signed and dated by the foreign exporter that the information in the movement document is complete and correct;

(xiii) Appropriate signatures for each custody transfer (e.g., transporter, importer, and owner or operator of the receiving facility);

(xiv) Each person that has physical custody of the waste from the time the movement commences until it arrives at the receiving facility must sign the movement document (e.g., transporter, importer, and owner or operator of the receiving facility); and

(xv) The receiving facility must send a copy of the signed movement document to confirm receipt within three (3) working days of shipment delivery to the foreign exporter, to the competent authorities of the countries of export and transit, and for shipments received on or after the electronic import-export reporting compliance date, to EPA electronically using EPA's Waste Import Export Tracking System (WIETS), or its successor system.

**Revise 61-79.262.84(e) to read:**

(e) Within three (3) working days of the receipt of imports subject to this subpart, the owner or operator of the U.S. recovery facility must send signed copies of the movement document to the exporter, to the Office of Enforcement and Compliance Assurance, Office of Federal Activities, International Compliance Assurance Division (2254A), Environmental Protection Agency, 1200 Pennsylvania Avenue, NW., Washington, DC 20460, and to the competent authorities of the countries of export and transit. If the concerned U.S. recovery facility is a R12/R13 recovery facility as defined under 262.81, the facility shall retain the original of the movement document for three (3) years. Duty to return or export hazardous wastes. When a transboundary movement of hazardous wastes cannot be completed in accordance with the terms

of the contract or the consent(s), the provisions of paragraph (f)(4) of this section apply. If alternative arrangements cannot be made to recover the hazardous waste in an environmentally sound manner in the United States, the hazardous waste must be returned to the country of export or exported to a third country. The provisions of paragraph (b)(6) of this section apply to any hazardous waste shipments to be exported to a third country. If the return shipment will cross any transit country, the return shipment may only occur after EPA provides notification to and obtains consent from the competent authority of the country of transit and provides a copy of that consent to the importer.

**Revise 61-79.262.84 to add subsections 262.84(f), 262.84(g), and 262.84(h) to read:**

(f) Import contract requirements.

(1) Imports of hazardous waste must occur under the terms of a valid written contract, chain of contracts, or equivalent arrangements (when the movement occurs between parties controlled by the same corporate or legal entity). Such contracts or equivalent arrangements must be executed by the foreign exporter, importer, and the owner or operator of the receiving facility, and must specify responsibilities for each. Contracts or equivalent arrangements are valid for the purposes of this section only if persons assuming obligations under the contracts or equivalent arrangements have appropriate legal status to conduct the operations specified in the contract or equivalent arrangements.

(2) Contracts or equivalent arrangements must specify the name and EPA ID number, where available, of paragraph (f)(2)(i) through (iv) of this section:

(i) The foreign company from where each import shipment of hazardous waste is initiated;

(ii) Each person who will have physical custody of the hazardous wastes;

(iii) Each person who will have legal control of the hazardous wastes; and

(iv) The receiving facility.

(3) Contracts or equivalent arrangements must specify the use of a movement document in accordance with section 262.84(d).

(4) Contracts or equivalent arrangements must specify which party to the contract will assume responsibility for alternate management of the hazardous wastes if their disposition cannot be carried out as described in the notification of intent to export submitted by either the foreign exporter or the importer. In such cases, contracts must specify that:

(i) The transporter or receiving facility having actual possession or physical control over the hazardous wastes will immediately inform the foreign exporter and importer, and the competent authority where the shipment is located of the need to arrange alternate management or return; and

(ii) The person specified in the contract will assume responsibility for the adequate management of the hazardous wastes in compliance with applicable laws and regulations including, if necessary, arranging the return of the hazardous wastes and, as the case may be, shall provide the notification for re-export required in section 262.83(b)(7).

(5) Contracts must specify that the importer or the receiving facility that performed interim recycling operations R12, R13, or RC16, or interim disposal operations D13 through D15 or DC15 through DC17,

as appropriate, will provide the notification required in section 262.83(b)(7) prior to the re-export of hazardous wastes. The recovery and disposal operations in this paragraph are defined in section 262.81.

(6) Contracts or equivalent arrangements must include provisions for financial guarantees, if required by the competent authorities of any countries concerned, in accordance with applicable national or international law requirements.

**Note to paragraph (f)(6)** Financial guarantees so required are intended to provide for alternate recycling, disposal or other means of sound management of the wastes in cases where arrangements for the shipment and the recovery operations cannot be carried out as foreseen. The United States does not require such financial guarantees at this time; however, some OECD Member countries or other foreign countries do. It is the responsibility of the importer to ascertain and comply with such requirements; in some cases, persons or facilities located in those countries may refuse to enter into the necessary contracts absent specific references or certifications to financial guarantees.

(7) Contracts or equivalent arrangements must contain provisions requiring each contracting party to comply with all applicable requirements of this subpart.

(8) Upon request by EPA, importers or disposal or recovery facilities must submit to EPA copies of contracts, chain of contracts, or equivalent arrangements (when the movement occurs between parties controlled by the same corporate or legal entity).

(g) Confirmation of recovery or disposal. The receiving facility must do the following:

(1) Send copies of the signed and dated confirmation of recovery or disposal, as soon as possible, but no later than thirty (30) days after completing recovery or disposal on the waste in the shipment and no later than one (1) calendar year following receipt of the waste, to the foreign exporter, to the competent authority of the country of export, and for shipments recycled or disposed of on or after the electronic import-export reporting compliance date, to EPA electronically using EPA's Waste Import Export Tracking System (WIETS), or its successor system.

(2) If the receiving facility performed any of recovery operations R12, R13, or RC16, or disposal operations D13 through D15, or DC17, the receiving facility shall promptly send copies of the confirmation of recovery or disposal that it receives from the final recovery or disposal facility within one (1) year of shipment delivery to the final recovery or disposal facility that performed one of recovery operations R1 through R11, or RC14 to RC15, or one of disposal operations D1 through D12, or DC15 to DC16, to the competent authority of the country of export, and for confirmations received on or after the electronic import-export reporting compliance date, to EPA electronically using EPA's Waste Import Export Tracking System (WIETS), or its successor system. The recovery and disposal operations in this paragraph are defined in R.61-79.262.81.

(h) Recordkeeping.

(1) The importer shall keep the following records and provide them to EPA or authorized state personnel upon request:

(i) A copy of each notification that the importer sends to EPA under paragraph (b)(1) of this section and each EPA AOC it receives in response for a period of at least three (3) years from the date the hazardous waste was accepted by the initial foreign transporter; and

(ii) A copy of each contract or equivalent arrangement established per paragraph (f) of this section for at least three (3) years from the expiration date of the contract or equivalent arrangement.

(2) The receiving facility shall keep the following records:

(i) A copy of each confirmation of receipt (i.e., movement document) that the receiving facility sends to the foreign exporter for at least three (3) years from the date it received the hazardous waste;

(ii) A copy of each confirmation of recovery or disposal that the receiving facility sends to the foreign exporter for at least three (3) years from the date that it completed processing the waste shipment;

(iii) For the receiving facility that performed any of recovery operations R12, R13, or RC16, or disposal operations D13 through D15, or DC17 (recovery and disposal operations defined in section 262.81), a copy of each confirmation of recovery or disposal that the final recovery or disposal facility sent to it for at least three (3) years from the date that the final recovery or disposal facility completed processing the waste shipment; and

(iv) A copy of each contract or equivalent arrangement established per paragraph (f) of this section for at least three (3) years from the expiration date of the contract or equivalent arrangement.

(3) Importers and receiving facilities may satisfy these recordkeeping requirements by retaining electronically submitted documents in the importer's or receiving facility's account on EPA's Waste Import Export Tracking System (WIETS), or its successor system, provided that copies are readily available for viewing and production if requested by any EPA or authorized state inspector. No importer or receiving facility may be held liable for the inability to produce such documents for inspection under this section if the importer or receiving facility can demonstrate that the inability to produce the document is due exclusively to technical difficulty with WIETS, or its successor system for which the importer or receiving facility bears no responsibility.

(4) The periods of retention referred to in this section are extended automatically during the course of any unresolved enforcement action regarding the regulated activity or as requested by the Department.

## **Revise 61-79.262.85 to remove and reserve:**

### **262.85–Contracts.**

~~(a) Transboundary movements of hazardous wastes subject to the Amber control procedures are prohibited unless they occur under the terms of a valid written contract, chain of contracts, or equivalent arrangements (when the movement occurs between parties controlled by the same corporate or legal entity). Such contracts or equivalent arrangements must be executed by the exporter and the owner or operator of the recovery facility, and must specify responsibilities for each. Contracts or equivalent arrangements are valid for the purposes of this section only if persons assuming obligations under the contracts or equivalent arrangements have appropriate legal status to conduct the operations specified in the contract or equivalent arrangements.~~

~~(b) Contracts or equivalent arrangements must specify the name and EPA ID number, where available, of paragraph (b)(1) through (b)(4) of this section:~~

~~(1) The generator of each type of waste;~~

~~(2) Each person who will have physical custody of the wastes;~~

~~— (3) Each person who will have legal control of the wastes; and~~

~~— (4) The recovery facility.~~

~~— (e) Contracts or equivalent arrangements must specify which party to the contract will assume responsibility for alternate management of the wastes if their disposition cannot be carried out as described in the notification of intent to export. In such cases, contracts must specify that:~~

~~— (1) The person having actual possession or physical control over the wastes will immediately inform the exporter and the competent authorities of the countries of export and import and, if the wastes are located in a country of transit, the competent authorities of that country; and~~

~~— (2) The person specified in the contract will assume responsibility for the adequate management of the wastes in compliance with applicable laws and regulations including, if necessary, arranging the return of wastes and, as the case may be, shall provide the notification for re-export.~~

~~— (d) Contracts must specify that the importer will provide the notification required in 262.82(e) prior to the re-export of controlled wastes to a third country.~~

~~— (e) Contracts or equivalent arrangements must include provisions for financial guarantees, if required by the competent authorities of any countries concerned in accordance with applicable national or international law requirements.~~

~~— **Note to Paragraph (e)** Financial guarantees so required are intended to provide for alternate recycling, disposal or other means of sound management of the wastes in cases where arrangements for the shipment and the recovery operations cannot be carried out as foreseen. The United States does not require such financial guarantees at this time; however, some OECD Member countries do. It is the responsibility of the exporter to ascertain and comply with such requirements; in some cases, transporters or importers may refuse to enter into the necessary contracts absent specific references or certifications to financial guarantees.~~

~~— (f) Contracts or equivalent arrangements must contain provisions requiring each contracting party to comply with all applicable requirements of this subpart.~~

~~— (g) Upon request by EPA, U.S. exporters, importers, or recovery facilities must submit to EPA copies of contracts, chain of contracts, or equivalent arrangements (when the movement occurs between parties controlled by the same corporate or legal entity). Information contained in the contracts or equivalent arrangements for which a claim of confidentiality is asserted in accordance with 40 CFR 2.203(b) will be treated as confidential and will be disclosed by EPA only as provided in 260.2.~~

~~— **Note to Paragraph (g)** Although the United States does not require routine submission of contracts at this time, the OECD Decision allows Member countries to impose such requirements. When other OECD Member countries require submission of partial or complete copies of the contract as a condition to granting consent to proposed movements, EPA will request the required information; absent submission of such information, some OECD Member countries may deny consent for the proposed movement. [Reserved]~~

**Revise 61-79.262.86 to remove and reserve:**

## **262.86 Provisions relating to recognized traders.**

~~—(a) A recognized trader who takes physical custody of a waste and conducts recovery operations (including storage prior to recovery) is acting as the owner or operator of a recovery facility and must be so authorized in accordance with all applicable federal laws.~~

~~—(b) A recognized trader acting as an exporter or importer for transboundary shipments of waste must comply with all the requirements of this subpart associated with being an exporter or importer. [Reserved]~~

## **Revise 61-79.262.87 to remove and reserve:**

### **262.87 Reporting and recordkeeping.**

~~—(a) Annual reports. For all waste movements subject to this subpart, persons (e.g., exporters, recognized traders) who meet the definition of primary exporter in 262.51 or who initiate the movement documentation under 262.84 shall file an annual report with the Office of Enforcement and Compliance Assurance, Office of Federal Activities, International Compliance Assurance Division (2254A), Environmental Protection Agency, 1200 Pennsylvania Avenue, NW., Washington, DC 20460, no later than March 1 of each year summarizing the types, quantities, frequency, and ultimate destination of all such hazardous waste exported during the previous calendar year. (If the primary exporter or the person who initiates the movement document under 262.84 is required to file an annual report for waste exports that are not covered under this subpart, he may include all export information in one report provided the following information on exports of waste destined for recovery within the designated OECD Member countries is contained in a separate section.) Such reports shall include all of the following paragraphs (a)(1) through (a)(6) of this section specified as follows:~~

~~—(1) The EPA identification number, name, and mailing and site address of the exporter filing the report;~~

~~—(2) The calendar year covered by the report;~~

~~—(3) The name and site address of each final recovery facility;~~

~~—(4) By final recovery facility, for each hazardous waste exported, a description of the hazardous waste, the EPA hazardous waste number (from part 261, subpart C or D), designation of waste type(s) and applicable waste code(s) from the appropriate OECD waste list incorporated by reference in 262.89(d), DOT hazard class, the name and U.S. EPA identification number (where applicable) for each transporter used, the total amount of hazardous waste shipped pursuant to this subpart, and number of shipments pursuant to each notification;~~

~~—(5) In even numbered years, for each hazardous waste exported, except for hazardous waste produced by exporters of greater than 100 kg but less than 1000 kg in a calendar month, and except for hazardous waste for which information was already provided pursuant to 262.41:~~

~~—(i) A description of the efforts undertaken during the year to reduce the volume and toxicity of the waste generated; and~~

~~—(ii) A description of the changes in volume and toxicity of the waste actually achieved during the year in comparison to previous years to the extent such information is available for years prior to 1984; and~~



~~— (6) A certification signed by the person acting as primary exporter or initiator of the movement document under 262.84 that states:~~

~~— (b) Exception reports. Any person who meets the definition of primary exporter in 262.51 or who initiates the movement document under 262.84 must file an exception report in lieu of the requirements of 262.42 (if applicable) with the Office of Enforcement and Compliance Assurance, Office of Federal Activities, International Compliance Assurance Division (2254A), Environmental Protection Agency, 1200 Pennsylvania Avenue, NW., Washington, DC 20460, if any of the following occurs:~~

~~— (1) He has not received a copy of the RCRA hazardous waste manifest (if applicable) signed by the transporter identifying the point of departure of the waste from the United States, within forty five (45) days from the date it was accepted by the initial transporter;~~

~~— (2) Within ninety (90) days from the date the waste was accepted by the initial transporter, the exporter has not received written confirmation from the recovery facility that the hazardous waste was received;~~

~~— (c) Recordkeeping:~~

~~— (1) Persons who meet the definition of primary exporter in 262.51 or who initiate the movement document under 262.84 shall keep the following records in paragraphs (c)(1)(i) through (c)(1)(iv) of this section:~~

~~— (i) A copy of each notification of intent to export and all written consents obtained from the competent authorities of countries concerned for a period of at least three (3) years from the date the hazardous waste was accepted by the initial transporter;~~

~~— (ii) A copy of each annual report for a period of at least three (3) years from the due date of the report;~~

~~— (iii) A copy of any exception reports and a copy of each confirmation of delivery (i.e., movement document) sent by the recovery facility to the exporter for at least three (3) years from the date the hazardous waste was accepted by the initial transporter or received by the recovery facility, whichever is applicable; and~~

~~— (iv) A copy of each certificate of recovery sent by the recovery facility to the exporter for at least three (3) years from the date that the recovery facility completed processing the waste shipment.~~

~~— (2) The periods of retention referred to in this section are extended automatically during the course of any unresolved enforcement action regarding the regulated activity or as requested by the Department. [Reserved]~~

**Add 61-79.262.88 and reserve:**

**262.88 [Reserved]**

**Revise 61-79.262.89 to remove and reserve:**

**~~262.89 OECD Waste Lists.~~**

~~(a) General. For the purposes of this Subpart, a waste is considered hazardous under U.S. national procedures, and hence subject to this Subpart, if the waste:~~

~~—(1) Meets the Federal definition of hazardous waste in 261.3; and~~

~~—(2) Is subject to either the Federal RCRA manifesting requirements at 262, subpart B, the universal waste management standards of 273, State requirements analogous to 273, the export requirements in the spent lead acid battery management standards of 266, subpart G, or State requirements analogous to the export requirements in part 266, subpart G.~~

~~—(b) If a waste is hazardous under paragraph (a) of this section, it is subject to the Amber control procedures, regardless of whether it appears in Appendix 4 of the OECD Decision, as defined in 262.81.~~

~~—(c) The appropriate control procedures for hazardous wastes and hazardous waste mixtures are addressed in 262.82.~~

~~—(d) The OECD waste lists, as set forth in Annex B ("Green List") and Annex C ("Amber List") (collectively "OECD waste lists") of the 2009 "Guidance Manual for the Implementation of Council Decision C(2001)107/FINAL, as Amended, on the Control of Transboundary Movements of Wastes Destined for Recovery Operations," are incorporated by reference. This incorporation by reference was approved by the Director of the Federal Register in accordance with 5 U.S.C. 552(a) and 1 CFR part 51. This material is incorporated as it exists on the date of the approval and a notice of any change in these materials will be published in the Federal Register. The materials are available for inspection at: the U.S. Environmental Protection Agency, Docket Center Public Reading Room, EPA West, Room 3334, 1301 Constitution Avenue NW., Washington, DC 20004 (Docket # EPA HQ RCRA 2005 0018) or at the National Archives and Records Administration (NARA), and may be obtained from the Organization for Economic Cooperation and Development, Environment Directorate, 2 rue André Pascal, F-75775 Paris Cedex 16, France. For information on the availability of this material at NARA, call 202-741-6030, or go to: <http://www.archives.gov/federal-register/cfr/ibr-locations.html>. To contact the EPA Docket Center Public Reading Room, call (202) 566-1744. To contact the OECD, call +33 (0) 1 45 24 81 67. [Reserved]~~

### **Revise 61-79.262 Appendix to Part 262 II Item 16 to read:**

For export shipments, the primary exporter must check the export box, and enter the point of exit (city and state) from the United States. For import shipments, the importer must check the import box and enter the point of entry (city and state) into the United States. For exports, the transporter must sign and date the manifest to indicate the day the shipment left the United States. ~~Transporters of hazardous waste shipments must deliver a copy of the manifest to the U.S. Customs when exporting the waste across U.S. borders.~~

### **Revise 61-79.263.10(d) to read:**

~~(d) A transporter of hazardous waste subject to the federal manifesting requirements of 262, or subject to the waste management standards of 273, or subject to State requirements analogous to 273, that is being imported from or exported to any of the countries listed in 262.58(a)(1) other country for purposes of recovery or disposal is subject to this subpart and to all other relevant requirements of subpart H of part 262R.61-79.262 subpart H, including, but not limited to, 262.84R.61-79.262.83(d) and 262.84(d) for movement documents.~~

### **Revise 61-79.263.20(a)(2) to read:**

~~(2) Exports. In the case of~~For exports other than those of hazardous waste subject to the requirements of subpart H of part 262 subpart H, a transporter may not accept such hazardous waste from a primary exporter or other person if he knows the shipment does not conform to the EPA Acknowledgment of

~~Consent; and unless, in addition to without a manifest signed by the generator as provided in this section, the transporter shall also be provided with an EPA Acknowledgment of Consent which, except for shipments by rail, is attached to the manifest (or shipping paper for exports by water [bulk shipment]). For exports of hazardous waste subject to the requirements of subpart H of 262, a transporter may not accept hazardous waste without a tracking document that includes all information required by 262.84. (12/92, 12/93, 9/98)in accordance with this section, as appropriate, and for exports occurring under the terms of a consent issued by EPA on or after December 31, 2016, a movement document that includes all information required by section 262.83(d).~~

**Revise 61-79.263.20(c) to read:**

(c) The transporter must ensure that the manifest accompanies the hazardous waste. In the case of exports occurring under the terms of a consent issued by EPA to the exporter on or after December 31, 2016, the transporter must ensure that a copy of the EPA Acknowledgment of Consent movement document that includes all information required by section 262.83(d) also accompanies the hazardous waste. In the case of imports occurring under the terms of a consent issued by EPA to the country of export or the importer on or after December 31, 2016, the transporter must ensure that a movement document that includes all information required by section 262.84(d) also accompanies the hazardous waste.

**Revise 61-79.263.20(e)(2) to read:**

(2) A shipping paper containing all the information required on the manifest (excluding the EPA identification numbers, generator certification, and signatures) and, for exports or imports occurring under the terms of a consent issued by EPA on or after December 31, 2016, an EPA Acknowledgment of Consent a movement document that includes all information required by sections 262.83(d) or 262.84(d) accompanies the hazardous waste; and

**Revise 61-79.263.20(f)(2) to read:**

(2) Rail transporters must ensure that a shipping paper containing all the information required on the manifest (excluding the EPA identification numbers, generator certification, and signatures) and, for exports or imports occurring under the terms of a consent issued by EPA on or after December 31, 2016, an EPA Acknowledgment of Consent a movement document that includes all information required by sections 262.83(d) or 262.84(d) accompanies the hazardous waste at all times. (amended 11/90).

**Note** Intermediate rail transporters are not required to sign either the manifest, movement document, or shipping paper.

**Revise 61-79.263.20(g)(4) and add items 263.20(g)(4)(i) and 263.20(g)(4)(ii) to read:**

(4) Give a copy of the manifest to a U.S. Customs official at the point of departure from the United States. For paper manifests only,

(i) Send a copy of the manifest to the e-Manifest system in accordance with the allowable methods specified in section 264.71(a)(2)(v); and

(ii) For shipments initiated prior to the AES filing compliance date, when instructed by the exporter to do so, give a copy of the manifest to a U.S. Customs official at the point of departure from the United States.

**Revise 61-79.264.12(a) to add items 264.12(a)(3) and 264.12(a)(4) to read:**

~~(a)(1) The owner or operator of a facility that is arranging or has arranged to receive hazardous waste—subject to 40 CFR part 262, subpart H from a foreign source must notify the Department in writing at least four weeks in advance of the date the waste is expected to arrive at the facility. Notice of subsequent shipments of the same waste from the same foreign source is not required. submit the following required notices: The owner or operator of a facility that is arranging or has arranged to receive hazardous waste subject to part 262 subpart H from a foreign source must submit the following required notices:~~

~~(1) The owner or operator of a facility that has arranged to receive hazardous waste from a foreign—source must notify the Department in writing at least four weeks in advance of the date the waste is expected to arrive at the facility. Notice of subsequent shipments of the same waste from the same foreign source is not required. As per section 262.84(b), for imports where the competent authority of the country of export does not require the foreign exporter to submit to it a notification proposing export and obtain consent from EPA and the competent authorities for the countries of transit, such owner or operator of the facility, if acting as the importer, must provide notification of the proposed transboundary movement in English to EPA using the allowable methods listed in section 262.84(b)(1) at least sixty (60) days before the first shipment is expected to depart the country of export. The notification may cover up to one (1) year of shipments of wastes having similar physical and chemical characteristics, the same United Nations classification, the same RCRA waste codes and OECD waste codes, and being sent from the same foreign exporter.~~

~~(2) The owner or operator of a recovery facility that has arranged to receive hazardous waste subject to part 262, subpart H must provide a copy of the movement document bearing all required signatures to—the foreign exporter; to the Office of Enforcement and Compliance Assurance, Office of Federal Activities, International Compliance Assurance Division (2254A), Environmental Protection Agency, 1200 Pennsylvania Avenue, NW., Washington, DC 20460; and to the competent authorities of all other countries concerned within three (3) working days of receipt of the shipment. The original of the signed movement document must be maintained at the facility for at least three (3) years. In addition, such owner or operator shall, as soon as possible, but no later than thirty (30) days after the completion of recovery and no later than one (1) calendar year following the receipt of the hazardous waste, send a certificate of recovery to the foreign exporter and to the competent authority of the country of export and to EPA's Office of Enforcement and Compliance Assurance at the above address by mail, e-mail without a digital signature followed by mail, or fax followed by mail. As per section 262.84(d)(2)(xv), a copy of the movement document bearing all required signatures within three (3) working days of receipt of the shipment to the foreign exporter; to the competent authorities of the countries of export and transit that control the shipment as an export and transit shipment of hazardous waste respectively; and on or after the electronic import-export reporting compliance date, to EPA electronically using EPA's Waste Import Export Tracking System (WIETS), or its successor system. The original of the signed movement document must be maintained at the facility for at least three (3) years. The owner or operator of a facility may satisfy this recordkeeping requirement by retaining electronically submitted documents in the facility's account on WIETS, or its successor system, provided that copies are readily available for viewing and production if requested by any EPA or authorized state inspector. No owner or operator of a facility may be held liable for the inability to produce the documents for inspection under this section if the owner or operator of a facility can demonstrate that the inability to produce the document is due exclusively to technical difficulty with WIETS, or its successor system for which the owner or operator of a facility bears no responsibility.~~

~~(3) As per section 262.84(f)(4), if the facility has physical control of the waste and it must be sent to an alternate facility or returned to the country of export, such owner or operator of the facility must inform EPA, using the allowable methods listed in section 262.84(b)(1) of the need to return or arrange alternate management of the shipment.~~

(4) As per section 262.84(g), such owner or operator shall:

(i) Send copies of the signed and dated confirmation of recovery or disposal, as soon as possible, but no later than thirty (30) days after completing recovery or disposal on the waste in the shipment and no later than one (1) calendar year following receipt of the waste, to the foreign exporter, to the competent authority of the country of export that controls the shipment as an export of hazardous waste, and for shipments recycled or disposed of on or after the electronic import-export reporting compliance date, to EPA electronically using EPA's WIETS, or its successor system.

(ii) If the facility performed any of recovery operations R12, R13, or RC16, or disposal operations D13 through D15, or DC17, promptly send copies of the confirmation of recovery or disposal that it receives from the final recovery or disposal facility within one year of shipment delivery to the final recovery or disposal facility that performed one of recovery operations R1 through R11, or RC16, or one of disposal operations D1 through D12, or DC15 to DC16, to the competent authority of the country of export that controls the shipment as an export of hazardous waste, and on or after the electronic import-export reporting compliance date, to EPA electronically using EPA's WIETS, or its successor system. The recovery and disposal operations in this paragraph are defined in section 262.81.

**Revise 61-79.264.71(a)(3) and add items 264.71(a)(3)(i) and 264.71(a)(3)(ii) to read:**

(3) If a facility receives hazardous waste imported from a foreign source, the receiving facility must mail a copy of the manifest and documentation confirming EPA's consent to the import of hazardous waste to the following address within thirty (30) days of delivery: Office of Enforcement and Compliance Assurance, Office of Federal Activities, International Compliance Assurance Division, (2254A), Environmental Protection Agency, 1200 Pennsylvania Avenue, N.W., Washington, DC 20460. The owner or operator of a facility receiving hazardous waste subject to part 262 subpart H, from a foreign source must:

(i) Additionally, list the relevant consent number from consent documentation supplied by EPA to the facility for each waste listed on the manifest, matched to the relevant list number for the waste from block 9b. If additional space is needed, the owner or operator should use a Continuation Sheet(s) (EPA Form 8700-22A); and

(ii) Send a copy of the manifest within thirty (30) days of delivery to EPA using the addresses listed in section 262.82(e) until the facility can submit such a copy to the e-Manifest system per paragraph (a)(2)(v) of this section.

**Revise 61-79.264.71(d) to read:**

(d) Within three (3) working days of the receipt of a shipment subject to part 262, subpart H, the owner or operator of a facility must provide a copy of the movement document bearing all required signatures to the exporter, to the Office of Enforcement and Compliance Assurance, Office of Federal Activities, International Compliance Assurance Division (2254A), Environmental Protection Agency, 1200 Pennsylvania Avenue, NW., Washington, DC 20460, and to competent authorities of all other concerned countries. The original copy of the movement document must be maintained at the facility for at least three (3) years from the date of signature. As per section 262.84(d)(2)(xv), within three (3) working days of the receipt of a shipment subject to part 262, subpart H, the owner or operator of a facility must provide a copy of the movement document bearing all required signatures to the foreign exporter; to the competent authorities of the countries of export and transit that control the shipment as an export and transit of hazardous waste respectively; and on or after the electronic import-export reporting compliance date, to EPA electronically using EPA's WIETS, or its successor system. The original copy of the movement

document must be maintained at the facility for at least three (3) years from the date of signature. The owner or operator of a facility may satisfy this recordkeeping requirement by retaining electronically submitted documents in the facility's account on WIETS, or its successor system, provided that copies are readily available for viewing and production if requested by any EPA or authorized state inspector. No owner or operator of a facility may be held liable for the inability to produce the documents for inspection under this section if the owner or operator of a facility can demonstrate that the inability to produce the document is due exclusively to technical difficulty with WIETS, or its successor system, for which the owner or operator of a facility bears no responsibility.

**Revise 61-79.265.12(a) and add items 265.12(a)(3) and 265.12(a)(4) to read:**

(a) The owner or operator of a facility that is arranging or has arranged to receive hazardous waste subject to part 262 subpart H from a foreign source must submit the following required notices:

(1) The owner or operator of a facility that has arranged to receive hazardous waste from a foreign source must notify the Department and the EPA Region IV Regional Administrator in writing at least four weeks in advance of the date the waste is expected to arrive at the facility. Notice of subsequent shipments of the same waste from the same foreign source is not required. As per section 262.84(b), for imports where the competent authority of the country of export does not require the foreign exporter to submit to it a notification proposing export and obtain consent from EPA and the competent authorities for the countries of transit, such owner or operator of the facility, if acting as the importer, must provide notification of the proposed transboundary movement in English to EPA using the allowable methods listed in section 262.84(b)(1) at least sixty (60) days before the first shipment is expected to depart the country of export. The notification may cover up to one (1) year of shipments of wastes having similar physical and chemical characteristics, the same United Nations classification, the same RCRA waste codes and OECD waste codes, and being sent from the same foreign exporter.

(2) The owner or operator of a recovery facility that has arranged to receive hazardous waste subject to part 262, subpart H must provide a copy of the movement document bearing all required signatures to the foreign exporter; to the Office of Enforcement and Compliance Assurance, Office of Federal Activities, International Compliance Assurance Division (2254A), Environmental Protection Agency, 1200 Pennsylvania Avenue, NW., Washington, DC 20460; and to the competent authorities of all other countries concerned within three (3) working days of receipt of the shipment. The original of the signed movement document must be maintained at the facility for at least three (3) years. In addition, such owner or operator shall, as soon as possible, but no later than thirty (30) days after the completion of recovery and no later than one (1) calendar year following the receipt of the hazardous waste, send a certificate of recovery to the foreign exporter and to the competent authority of the country of export and to EPA's Office of Enforcement and Compliance Assurance at the above address by mail, e-mail without a digital signature followed by mail, or fax followed by mail. As per section 262.84(d)(2)(xv), a copy of the movement document bearing all required signatures within three (3) working days of receipt of the shipment to the foreign exporter; to the competent authorities of the countries of export and transit that control the shipment as an export and transit shipment of hazardous waste respectively; and on or after the electronic import-export reporting compliance date, to EPA electronically using EPA's WIETS, or its successor system. The original of the signed movement document must be maintained at the facility for at least three (3) years. The owner or operator of a facility may satisfy this recordkeeping requirement by retaining electronically submitted documents in the facility's account on WIETS, or its successor system, provided that copies are readily available for viewing and production if requested by any EPA or authorized state inspector. No owner or operator of a facility may be held liable for the inability to produce the documents for inspection under this section if the owner or operator of a facility can demonstrate that the inability to produce the document is due exclusively to technical difficulty with WIETS, or its successor system, for which the owner or operator of a facility bears no responsibility.

(3) As per section 262.84(f)(4), if the facility has physical control of the waste and it must be sent to an alternate facility or returned to the country of export, such owner or operator of the facility must inform EPA, using the allowable methods listed in section 262.84(b)(1) of the need to return or arrange alternate management of the shipment.

(4) As per section 262.84(g), such owner or operator shall:

(i) Send copies of the signed and dated confirmation of recovery or disposal, as soon as possible, but no later than thirty (30) days after completing recovery or disposal on the waste in the shipment and no later than one (1) calendar year following receipt of the waste, to the foreign exporter, to the competent authority of the country of export that controls the shipment as an export of hazardous waste, and on or after the electronic import-export reporting compliance date, to EPA electronically using EPA's WIETS, or its successor system.

(ii) If the facility performed any of recovery operations R12, R13, or RC16, or disposal operations D13 through D15, or DC17, promptly send copies of the confirmation of recovery or disposal that it receives from the final recovery or disposal facility within one (1) year of shipment delivery to the final recovery or disposal facility that performed one of recovery operations R1 through R11, or RC16, or one of disposal operations D1 through D12, or DC15 to DC16, to the competent authority of the country of export that controls the shipment as an export of hazardous waste, and on or after the electronic import-export reporting compliance date, to EPA electronically using EPA's WIETS, or its successor system. The recovery and disposal operations in this paragraph are defined in section 262.81.

**Revise 61-79.265.71(a)(3) and add items 265.71(a)(3)(i) and 265.71(a)(3)(ii) to read:**

~~(3) If a facility receives hazardous waste imported from a foreign source, the receiving facility must mail a copy of the manifest and documentation confirming EPA's consent to the import of hazardous waste to the following address within thirty (30) days of delivery: Office of Enforcement and Compliance Assurance, Office of Federal Activities, International Compliance Assurance Division (2254A), Environmental Protection Agency, 1200 Pennsylvania Avenue, N.W., Washington, DC 20460. The owner or operator of a facility that receives hazardous waste subject to part 262, subpart H, from a foreign source must:~~

(i) Additionally, list the relevant consent number from consent documentation supplied by EPA to the facility for each waste listed on the manifest, matched to the relevant list number for the waste from block 9b. If additional space is needed, the owner or operator should use a Continuation Sheet(s) (EPA Form 8700-22A); and

(ii) Send a copy of the manifest to EPA using the addresses listed in section 262.82(e) within thirty (30) days of delivery until the facility can submit such a copy to the e-Manifest system per paragraph (a)(2)(v) of this section.

**Revise 61-79.265.71(d) to read:**

~~(d) Within three (3) working days of the receipt of a shipment subject to part 262, subpart H, the owner or operator of a facility must provide a copy of the movement document bearing all required signatures to the exporter, to the Office of Enforcement and Compliance Assurance, Office of Federal Activities, International Compliance Assurance Division (2254A), Environmental Protection Agency, 1200 Pennsylvania Avenue, NW., Washington, DC 20460, and to competent authorities of all other countries concerned. The original copy of the movement document must be maintained at the facility for at least three~~

~~(3) years from the date of signature.~~ As per section 262.84(d)(2)(xv), within three (3) working days of the receipt of a shipment subject to part 262, subpart H, the owner or operator of a facility must provide a copy of the movement document bearing all required signatures to the foreign exporter; to the competent authorities of the countries of export and transit that control the shipment as an export and transit shipment of hazardous waste respectively; and on or after the electronic import-export reporting compliance date, to EPA electronically using EPA's WIETS, or its successor system. The original copy of the movement document must be maintained at the facility for at least three (3) years from the date of signature. The owner or operator of a facility may satisfy this recordkeeping requirement by retaining electronically submitted documents in the facility's account on WIETS, or its successor system, provided that copies are readily available for viewing and production if requested by any EPA or authorized state inspector. No owner or operator of a facility may be held liable for the inability to produce the documents for inspection under this section if the owner or operator of a facility can demonstrate that the inability to produce the document is due exclusively to technical difficulty with WIETS, or its successor system, for which the owner or operator of a facility bears no responsibility.

**Revise 61-79.266.70(b) to read:**

(1) Notification requirements under SC Hazardous Waste Management Act 44-56-120 and section 3010 of RCRA.;

**Revise 61-79.266.70(b)(3) to read:**

(3) For precious metals exported to or imported from ~~designated OECD member~~ other countries for recovery, ~~part 262 subpart H of part 262 and 265.12(a)(2) of this chapter.~~ For precious metals exported to or imported from non-OECD countries for recovery, subparts E and F of 262.

**Revise 61-79.266.80(a) to read:**

Table 1 – 266.80 Applicability and requirements			
If your batteries...	And if you...	Then you...	And you...
(1) Will be reclaimed through regeneration (such as by electrolyte replacement)		are exempt from 40 CFR parts 262 (except for section 262.11), 263, 264, 265, 266, 268, 270, 124 of this chapter, and the notification requirements at section 3010 of RCRA	are subject to 261 and section 262.11.
(2) Will be reclaimed other than through regeneration	store these batteries but you aren't the reclaimer.	are exempt from 262 (except for 262.11), 263, 264, 265, 266, 270, 124 of this chapter, and the notification requirements of South Carolina HWMA 44-56-120 and at section 3010 of RCRA	are subject to 261 and 262.11, and applicable provisions under 268.
(3) Will be reclaimed other than through regeneration	store these batteries but you aren't the reclaimer.	are exempt from 262 (except for 262.11), 263, 264, 265, 266, 270, 124, and the provisions under notification requirements of South Carolina HWMA 44-56-120 and at section 3010 of RCRA.	are subject to 261, 262.11, and applicable 268.



(4) Will be reclaimed other than through regeneration	store these batteries before you reclaim them.	must comply with 40 CFR 266.80(b) and as appropriate other regulatory provisions described in 266.80(b)	are subject to 261, 262.11, and applicable provisions under 268.
(5) Will be reclaimed other than through regeneration	don't store these batteries before you reclaim them.	are exempt from 262 (except for 262.11), 263, 264, 265, 266, 270, 124, and the notification requirements of South Carolina HWMA 44-56-120 and at section 3010 of RCRA	are subject to 261, 262.11, and applicable provisions under 268
(6) Will be reclaimed through regeneration or any other means	export these batteries for reclamation in a foreign country	<p>are exempt from 40 CFR parts <del>R.61-79.262</del> (except for R.61-79.262.11, 262.18 and subpart H), 263, 264, 265, 266, 268, 270, 124 of this chapter, and the notification requirements at the SC Hazardous Waste Management Act 44-56-120 and section 3010 of RCRA. You are also exempt from part 262, except for 262.11, and except for the applicable requirements in either: (1) 40 CFR part 262 subpart H; or (2) 262.53 "Notification of Intent to Export, 262.56(a)(1) through (4)(6) and (b) "Annual Reports," and 262.57 "Recordkeeping</p>	<p>are subject to <del>40 CFR part 261 and 262.11</del> and either must comply with <del>part 262, subpart H (if shipping to one of the OECD countries specified in 40 CFR 262.58(a)(1));</del> or must:</p> <p>(a) <del>Comply with the requirements applicable to a primary exporter in 40 CFR 262.53, 262.56(a)(1) through (4), (6), and (b) and 262.57; and</del></p> <p>(b) <del>Export these batteries only upon consent of the receiving country and in conformance with the EPA Acknowledgment of Consent as defined in subpart E of part 262 of this chapter; and</del></p> <p>(c) <del>Provide a copy of the EPA Acknowledgment of Consent for the shipment to the transporter transporting the shipment for export. R.61-79.261, 262.11,</del></p>

			<u>262.18, and 262 subpart H.</u>
(7) Will be reclaimed through regeneration or any other means	Transport these batteries in the U.S. to export them for reclamation in a foreign country	are exempt from <del>40 CFR parts R.61-79.263, 264, 265, 266, 268, 270, 124 of this chapter,</del> and the notification requirements at the <u>SC Hazardous Waste Management Act 44-56-120 and section 3010 of RCRA</u>	must comply with applicable requirements in <del>40 CFR part R.61-79.262, subpart H (if shipping to one of the OECD countries specified in 40 CFR 262.58(a)(1));</del> or must comply with the following: <del>(a) you may not accept a shipment if you know the shipment does not conform to the EPA Acknowledgment of Consent;</del> <b>(a) you may not accept a shipment if you know the shipment does not conform to the EPA Acknowledgment of Consent;</b> <del>(b) you must ensure that a copy of the EPA Acknowledgment of Consent accompanies the shipment; and</del> <b>(b) you must ensure that a copy of the EPA Acknowledgment of Consent accompanies the shipment; and</b> <del>(c) you must ensure that the shipment is delivered to the facility designated by the person initiating the shipment.</del> <b>(c) you must ensure that the shipment is delivered to the facility designated by the person initiating the shipment.</b>
<u>(8) Will be reclaimed other than through regeneration</u>	<u>Import these batteries from foreign country and store these batteries but you aren't the reclaimer</u>	<u>are exempt from R.61-79.262 (except for R.61-79.262.11, 262.18 and subpart H), 263, 264, 265, 266, 270, 124, and the notification requirements at the SC Hazardous Waste Management Act 44-56-120 and section 3010 of RCRA</u>	<u>are subject to R.61-79.261, 262.11, 262.18, 262 subpart H, and applicable provisions under R.61-79.268.</u>
<u>(9) Will be reclaimed other than through regeneration</u>	<u>Import these batteries from foreign country and store these batteries before you reclaim them</u>	<u>must comply with section 266.80(b) and as appropriate other regulatory provisions described in section 266.80(b)</u>	<u>are subject to R.61-79.261, 262.11, 262.18, 262 subpart H, and applicable provisions under R.61-79.268.</u>

<u>(10) Will be reclaimed other than through regeneration</u>	<u>Import these batteries from foreign country and don't store these batteries before you reclaim them</u>	<u>are exempt from R.61-79.262 (except for R.61-79.262.11, 262.18 and subpart H), 263, 264, 265, 266, 270, 124, and the notification requirements at SC Hazardous Waste Management Act 44-56-120 and section 3010 of RCRA</u>	<u>are subject to R.61-79.261, 262.11, 262.18, 262 subpart H, and applicable provisions under R.61-79.268.</u>
---	--	---	--

**Revise 61-79.273.20 to read:**

A small quantity handler of universal waste who sends universal waste to a foreign destination ~~other than to those OECD countries specified in 262.58(a)(1) (in which case the handler is subject to the requirements of part 262, subpart H) must.~~

**Revise 61-79.273.39(a) to read:**

(a) Receipt of shipments. A large quantity handler of universal waste must keep a record of each shipment of universal waste received at the facility. The record may take the form of a log, invoice, manifest, bill of lading, movement document or other shipping document. The record for each shipment of universal waste received must include the following information:

**Revise 61-79.273.39(b) to read:**

(b) Shipments off-site. A large quantity handler of universal waste must keep a record of each shipment of universal waste sent from the handler to other facilities. The record may take the form of a log, invoice, manifest, bill of lading, movement document or other shipping document. The record for each shipment of universal waste sent must include the following information:

**Revise 61-79.273.40 to read:**

A large quantity handler of universal waste who sends universal waste to a foreign destination ~~other than to those OECD countries specified in 262.58(a)(1) (in which case the handler is subject to the requirements of part 262, subpart H) must.~~

**Revise 61-79.273.56 to read:**

A universal waste transporter transporting a shipment of universal waste to a foreign destination ~~other than to those OECD countries specified in 262.58(a)(1) (in which case the transporter is subject to the requirements of part 262, subpart H) may not accept a shipment if the transporter knows the shipment does not conform to the EPA Acknowledgment of Consent. In addition the transporter must ensure that.~~

**Revise 61-79.273.62(a) to read:**

(a) The owner or operator of a destination facility must keep a record of each shipment of universal waste received at the facility. The record may take the form of a log, invoice, manifest, bill of lading, movement document or other shipping document. The record for each shipment of universal waste received must include the following information:

**Revise 61-79.273.70 to read:**

Persons managing universal waste that is imported from a foreign country into the United States are subject to the requirements of part 262, subpart H, and the applicable requirements of this part, immediately after the waste enters the United States, as indicated in paragraphs (a) through (c) of this section:

## **ATTACHMENT C**

### **DEPARTMENT OF HEALTH AND ENVIRONMENTAL CONTROL**

#### **CHAPTER 61**

Statutory Authority: 1976 Code Section 44-56-30

#### **Notice of Drafting:**

The Department of Health and Environmental Control (“Department”) proposes to amend Regulation 61-79, Hazardous Waste Management Regulations. Interested persons may submit comments in writing to David Scaturo, Director of the Division of Waste Management, Bureau of Land and Waste Management, 2600 Bull Street, Columbia, S.C. 29201 or via email at [scaturdm@dhec.sc.gov](mailto:scaturdm@dhec.sc.gov). To be considered, comments must be received no later than 5:00 p.m. on May 28, 2018, the close of the draft comment period.

#### **Synopsis:**

The Department proposes amending Regulation 61-79 to adopt a final rule published in the Federal Register by the United States Environmental Protection Agency (“EPA”). The final rule is summarized below. The Department proposes adopting the “Imports and Exports of Hazardous Waste” Rule, published on November 28, 2016 at 81 FR 85696-85729 and 82 FR 41015-41016. The rule amends existing requirements regarding the export and import of hazardous wastes from and into the United States. The Department proposes adopting the rule to maintain compliance with federal law and provide greater protection to human health and the environment by:

1. Making existing export and import related requirements more consistent with the current import-export requirements for shipments between members of the Organization for Economic Cooperation and Development,
2. Enabling electronic submittal to the EPA of all export and import-related documents (e.g., export notices, export annual reports), and
3. Enabling electronic validation of consent in the Automated Export System for export shipments subject to Resource Conservation and Recovery Act export consent requirements prior to exit.

The Department may also include stylistic changes, such as corrections for clarity and readability, grammar, punctuation, definitions, references, codification, and overall improvement of the text of the regulation.

General Assembly review is not required.

(x) ACTION/DECISION  
( ) INFORMATION

Date: October 11, 2018

To: S.C. Board of Health and Environmental Control

From: The Bureau of Communicable Disease Prevention and Control

**Re: Notice of Proposed Regulation for Amending R.61-120, *South Carolina Immunization Registry*.**

### **I. Introduction**

The Bureau of Communicable Disease Prevention and Control (“Bureau”) proposes the attached Notice of Proposed Regulation amending R.61-120, *South Carolina Immunization Registry*, for publication in the October 26, 2018, *South Carolina State Register* (“*State Register*”). Legal authority resides in Section 44-29-40 of the South Carolina Code of Laws, which requires the Department of Health and Environmental Control (“Department”) to establish a statewide immunization registry and promulgate regulations for its operation and implementation. The Administrative Procedures Act, S.C. Code Section 1-23-120(A), requires General Assembly review of this amendment.

### **II. Facts**

1. R.61-120, *South Carolina Immunization Registry*, is governed by S.C. Code Section 44-29-40, which grants the Department general direction and supervision of vaccination, screening, and immunization in the state. Section 44-29-40(B) charges the Department with establishing a statewide immunization registry and promulgating regulations for the implementation and operation of the registry.
2. The Bureau proposes amending R.61-120 to enable the Department to provide specific Healthcare Effectiveness Data and Information Set (“HEDIS”) data from the South Carolina Immunization Registry (“Registry”) to health plans for public health purposes and to measure performance on important dimensions of care and service, including immunization data for clients. Proposed amendments are also intended to provide details regarding the availability and use of a patient portal, which will be a feature of a new Registry allowing patients to access their personal immunization records. The proposed amendments will also remove obsolete language and make general improvements and clarifications to the text.
2. The Department had a Notice of Drafting published in the April 27, 2018, *State Register*. A copy of the Notice of Drafting appears herein as Attachment B. The Department received no public comments by the May 28, 2018, close of the public comment period.
3. Staff from the Immunization Division conducted a stakeholder meeting on August 7, 2018. Stakeholder response to the proposed regulations were favorable.
4. Appropriate Department staff conducted an internal review of the proposed amendments on August 29, 2018.

### **III. Request for Approval**

The Bureau respectfully requests the Board to grant approval of the attached Notice of Proposed Regulation for publication in the October 26, 2018, *State Register*.

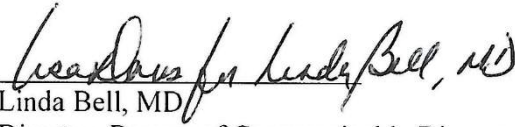
  
Linda Bell, MD  
Director, Bureau of Communicable Disease  
Prevention and Control

  
Lilian R. Peake, MD, MPH  
Director, Public Health

Attachments:

- A. Notice of Proposed Regulation
- B. Notice of Drafting published in the April 27, 2018, *State Register*

**ATTACHMENT A**

**STATE REGISTER NOTICE OF PROPOSED REGULATION  
FOR REGULATION 61-120, *South Carolina Immunization Registry***

**October 11, 2018**

Document No. \_\_\_\_\_

**DEPARTMENT OF HEALTH AND ENVIRONMENTAL CONTROL  
CHAPTER 61**

Statutory Authority: 1976 Code Section 44-29-40

61-120. South Carolina Immunization Registry.

**Preamble:**

The Department of Health and Environmental Control (“Department”) proposes amending R.61-120 to enable the Department to provide specific Healthcare Effectiveness Data and Information Set (“HEDIS”) data from the South Carolina Immunization Registry (“Registry”) to health plans for public health purposes and to measure performance on important dimensions of care and service, including immunization data for clients. Proposed amendments are also intended to provide details regarding the availability and use of a patient portal, which will be a feature of a new Registry allowing patients to access their personal immunization records. The proposed amendments will also remove obsolete language and make general improvements and clarifications to the text. General Assembly review is required.

The Department had a Notice of Drafting published in the April 27, 2018, South Carolina State Register.

**Section-by-Section Discussion of Proposed Amendment:**

The Table of Contents is revised to reflect the changes in the proposed text of the regulation.

Section C.1.a is revised to delete language pertaining to the implementation schedule of the Registry, which has already occurred, and to clarify the registration requirements for immunization providers. Section C.2.a is revised for punctuation. Section C.8 is revised to update a section reference.

Section D, Implementation Schedule, is deleted in its entirety.

Section E, Permitted Uses and Disclosure of Immunization Registry Information, is recodified to Section D, same title. Section D.4.c is revised to clarify that the Department may print a South Carolina Certificate of Immunization for a patient upon written request of the patient, parent or legal guardian. New Section D.4.d is added to allow a patient, parent or legal guardian to obtain a copy of the patient’s immunization record through a Department authorized electronic patient portal. Section D.4.o (formerly D.4.n) is revised for punctuation and clarity. New Section D.4.p is added to provide an immunization record to health plans of its members and enrollees who received immunization during the time in which they were enrolled, which shall be used solely for public health and HEDIS purposes. The outline enumeration for this section has been revised accordingly.

Section E.3, previously Section F.3, is revised to update a section reference.

**Notice of Public Hearing and Opportunity for Public Comment:**



Interested persons may submit comment(s) on the proposed amendment by mail to Stephen White, Immunization Division, Communicable Disease Prevention and Control, 2100 Bull Street, Columbia, S.C. 29201, or via email at [immunizationregulation@dhec.sc.gov](mailto:immunizationregulation@dhec.sc.gov). To be considered, the Department must receive the comment(s) by 5:00 p.m. on November 26, 2018, the close of the comment period.

The S.C. Board of Health and Environmental Control will conduct a public hearing on the proposed amendment during its December 13, 2018, 10:00 a.m. meeting. Interested persons may make oral and/or submit written comments at the public hearing. Persons making oral comments should limit their statements to five (5) minutes or less. The meeting will take place in the Board Room of the DHEC Building, located at 2600 Bull Street, Columbia, S.C. 29201. Due to admittance procedures, all visitors must enter through the main Bull Street entrance and register at the front desk. The Department will publish a meeting agenda twenty-four (24) hours in advance indicating the order of its scheduled items at: <http://www.scdhec.gov/Agency/docs/AGENDA.PDF>.

The Department publishes a Monthly Regulation Development Update tracking the status of its proposed new regulations, amendments, and repeals and providing links to associated State Register documents at <http://www.scdhec.gov/Agency/RegulationsAndUpdates/RegulationDevelopmentUpdate/>.

### **Preliminary Fiscal Impact Statement**

There are no anticipated additional costs to the state and its political subdivisions.

### **Statement of Need and Reasonableness**

The following presents an analysis of the factors listed in 1976 Code Section 1-23-115(C)(1)-(3) and (9)-(11):

DESCRIPTION OF REGULATION: 61-120, South Carolina Immunization Registry.

Purpose: The purpose of these proposed amendments to R.61-120 is to enable the Department to provide specific HEDIS data from the Registry to health plans for public health purposes and measure performance on important dimensions of care and service, including immunization data for clients. Proposed amendments are also intended to provide details regarding the availability and use of a patient portal, which will be a feature of a new Registry allowing patients to access their personal immunization records. The proposed amendments will also remove obsolete language and make general improvements and clarifications to the text.

Legal Authority: 1976 Code Section 44-29-40.

Plan for Implementation: The DHEC Regulation Development Update (accessible at <http://www.scdhec.gov/Agency/RegulationsAndUpdates/RegulationDevelopmentUpdate/>) provides a summary of and link to this proposed amendment. Additionally, printed copies are available for a fee from the Department's Freedom of Information Office. Upon taking legal effect, Department personnel will take appropriate steps to inform the regulated community of the amendment and any associated information.

### **DETERMINATION OF NEED AND REASONABLENESS OF THE PROPOSED REGULATION BASED ON ALL FACTORS HEREIN AND EXPECTED BENEFITS:**

The Department promulgated R.61-120 pursuant to Section 44-29-40 of the South Carolina Code of Laws, which requires the Department to establish a statewide immunization registry and promulgate regulations for its operation and implementation. The amendments to R.61-120 are needed in order to enable the

provision of HEDIS data to health plans to be used for public health purposes, including analysis of immunization data for clients. Additionally, amendments will allow patients to access their personal immunization records once the new Registry becomes active and without the need of going through one's healthcare provider. These amendments will benefit the public through greater analysis of immunization rates and coverage, as well as easier access to one's personal immunization record.

**DETERMINATION OF COSTS AND BENEFITS:**

There are no anticipated costs to the state or its political subdivisions. The amendment establishing a patient portal for the Registry is expected to lessen the costs, both in time and money, associated with getting a copy of one's personal immunization record.

**UNCERTAINTIES OF ESTIMATES:**

None.

**EFFECT ON THE ENVIRONMENT AND PUBLIC HEALTH:**

Implementation of the proposed amendments herein will not compromise the protection of the environment or public health. Provision of HEDIS data to health plans is expected to benefit public health through additional analysis of immunization coverage.

**DETRIMENTAL EFFECT ON THE ENVIRONMENT AND PUBLIC HEALTH IF THE REGULATION IS NOT IMPLEMENTED:**

There is no anticipated detrimental effect on the environment if the amendments are not implemented. Failure to amend the regulation could negatively impact public health to the extent that the benefits of the amendments would not be realized.

**Statement of Rationale:**

The Department proposes amending R.61-120 to enable the Department to provide specific HEDIS data from the Registry to health plans for public health purposes and to measure performance on important dimensions of care and service, including immunization data for clients. Proposed amendments are also intended to provide details regarding the availability and use of a patient portal, which will be a feature of a new Registry allowing patients to access their personal immunization records. The proposed amendments will also remove obsolete language and make general improvements and clarifications to the text.

**Text:**

~~Indicates Matter Stricken~~  
Indicates New Matter

61-120. South Carolina Immunization Registry.

Statutory Authority: 1976 Code Section 44-29-40

**Table of Contents:**

- A. Purpose and Scope.
- B. Definitions.

- C. Registration and Reporting Requirements.
- ~~D. Implementation Schedule.~~
- ~~E.D.~~ Permitted Uses and Disclosures of Immunization Registry Information.
- ~~F.E.~~ Compliance and Enforcement.
- ~~G.F.~~ Exceptions to Regulation.
- ~~H.G.~~ Severability.

A. Purpose and Scope.

The purpose of this regulation is to provide rules, implementing Section 44-29-40 of the S.C. Code of Laws, 1976, as amended, regarding the South Carolina Immunization Registry requirements for reporting immunizations occurring in South Carolina, implementation and operation of the registry, data elements to be collected, content of electronic forms and reports, and the procedures for disclosure of confidential registry information. This regulation will apply to all healthcare providers who give immunizations in South Carolina. Nothing in this regulation shall be construed to affect statutory or common law principles governing the liabilities of health care providers for acts or omissions of their employees, agents, or contractors. Nothing in this regulation shall be construed to conflict with any state law or regulation governing immunizations or to alter, add to, or eliminate any requirement of state law or regulation regarding the administration of immunizations or to regulate the practice of any of the health care professions.

B. Definitions.

1. AUTHORIZED USER means an employee of an immunization provider who has been identified during the registration process as a user of the registry.
2. DEPARTMENT means the Department of Health and Environmental Control.
3. IMMUNIZATION PROVIDER means an individual health care provider licensed, certified, registered, or otherwise authorized by law to provide immunizations, and an organization, facility, or other entity that provides immunizations through such individual providers.
4. PATIENT means an individual who receives an immunization or other health care services.
5. REGISTRY means the data system for the collection, storage, and dissemination of information on immunizations administered in South Carolina established by the Department pursuant to Section 44-29-40.

C. Registration and Reporting Requirements.

1. Immunization providers shall register with the Department for access to the Registry.
  - a. ~~Existing immunization providers shall register with the Department within ninety (90) days from the effective date of this regulation. New immunization providers, such as health care professionals and entities licensed or organized after the effective date of this regulation, All immunization providers~~ shall register with the Department before administering any immunizations for which reporting is required under the implementation schedule in this regulation. This section governs only the registration requirement and is not intended to prohibit or restrict the administration of immunizations by any person authorized by law to do so.

b. Authorized users shall complete training under schedules established by the Department in a format determined by the Department. The Department will contact registered users to schedule and provide the training and other needed activities in order to use the registry. Immunization providers will not be responsible for completing the reporting requirements of this regulation until necessary training and set up have been completed by the Department.

c. An immunization provider that is a facility or business entity administering vaccines through employees, agents, or contractors may register in its own name, and the employees, agents, and contractors of such facilities or business entities need not register individually. An immunization provider that is a business entity with multiple locations may register once as a single provider for more than one location. Individual immunization providers who practice in a group or with a facility or business entity may register individually or in the name of the group or facility or business entity.

2. Each immunization provider shall identify one or more employees who will be authorized users of the registry on behalf of the immunization provider.

a. All authorized users shall maintain the confidentiality of their individual access codes and passwords for the immunization registry; and shall not share or exchange such codes with any other person, regardless of whether or not that other person is an authorized user.

b. Each immunization provider and authorized user shall be individually responsible for complying with this regulation and the user agreement. The immunization provider shall be responsible, according to existing principles of agency law, for its authorized users' access to the registry and uses and disclosures of registry information, and compliance with this regulation and the user agreement.

c. Immunization providers and authorized users shall enter into and comply with user agreements specifying terms of use and confidentiality and other obligations. A breach of a user agreement is a violation of this regulation.

3. The immunization provider shall notify the Department within fifteen (15) business days after an authorized user is terminated or leaves employment for any reason. The immunization provider shall not be liable for applicable statutory penalties for its authorized users' post-employment violations of this regulation, if the immunization provider has notified the Department that the authorized user is no longer employed. This regulation shall not be construed to affect the immunization provider's liability to any third party for acts or omissions of its employee or other authorized user.

4. Immunization providers shall report all immunizations administered to the registry within ten (10) business days of administration. Immunizations shall be reported in a standard electronic format specified by the Department via the internet at a website specified by the Department, or via the South Carolina Health Information Exchange or other method specified by the Department. An immunization provider that is a facility or business entity administering vaccines through employees, agents, or contractors shall report immunizations administered by its employees, agents, and contractors.

5. For each immunization administered, immunization providers shall report, at a minimum, the date of immunization; specific type of vaccine given; first and last name, gender, and date of birth of the person receiving the vaccine; and name of the registered immunization provider. The Department may require reporting of other data as needed to comply with federal requirements.

6. In the event of a state or federal declared disaster, state of emergency, or public health emergency, at the Department's discretion, immunization providers shall report to the Department information regarding

administration or dispensing of certain drugs, medications, chemicals, vaccines, or biological products used in response to the declared disaster, state of emergency, or public health emergency.

7. Immunization providers in other states who administer immunizations in South Carolina must comply with the requirements of this regulation. Immunization providers who administer immunizations in other states to South Carolina residents are not required to register with or report immunizations administered out of state to the registry, but may register and report voluntarily. Out-of-state immunization providers who register voluntarily are subject to and must comply with the provisions of this regulation governing permitted uses and disclosures of registry information and compliance and enforcement as fully as if located in and administering immunizations in South Carolina.

8. Immunization providers who do not administer vaccines may register with the Department for access to the registry. Immunization providers who register under this paragraph and their authorized users are subject to and will comply with all provisions of this regulation applicable to immunization providers and authorized users and may access and use registry information under Section ~~ED~~.

#### ~~D. Implementation Schedule.~~

~~—1. Immunization providers will enter all immunizations into the registry on the following schedule, according to the date of administration and date of birth of the immunized patient:~~

~~— a. All immunizations administered after December 31, 2013, or the effective date of this regulation, whichever is later, to children born after December 31, 2013, and to adults born before 1946;~~

~~— b. All immunizations administered after December 31, 2014, to children born after December 31, 2008, and to adults born before 1950;~~

~~— c. All immunizations administered after December 31, 2015 to children born after December 31, 2003 and to adults born before 1961;~~

~~— d. All immunizations administered after December 31, 2016.~~

~~—2. Immunizations administered before the designated dates are not required to be entered in the Registry, but may be entered voluntarily.~~

#### ~~ED. Permitted Uses and Disclosures of Immunization Registry Information.~~

1. Information in the immunization registry is confidential and shall be made available only to registered immunization providers through their authorized users. Immunizations providers who have registered for access to the registry may obtain information from the registry pertaining only to their own patients.

2. Immunization providers may use registry information for the following purposes:

- a. To provide care and treatment to their patients;
- b. To determine appropriate and needed immunizations for their patients;
- c. To generate reports to review their practice's coverage;
- d. To generate reminder and recall notices;

- e. To review their practice's immunizations for quality improvement purposes;
  - f. To print a patient's immunization record;
  - g. To print a South Carolina Certificate of Immunization for a patient for school and daycare attendance; and for
  - h. Other uses specifically authorized by the Department.
3. Immunization providers and authorized users may not disclose identifying information obtained from the registry except as allowed or required by applicable law.
4. The Department may use registry information for public health purposes, including, but not limited to, the following:
- a. To determine appropriate and needed immunizations for patients;
  - b. To print a patient's immunization record at the request or with permission of an immunization provider;
  - c. To print a copy of an patient's immunization record or a South Carolina Certificate of Immunization for a patient and at the written request of athe patient, or a parent or legal guardian of the patient if the patient is under eighteen (18) years of age;
  - d. To allow a patient, or a parent or legal guardian of the patient if the patient is under eighteen (18) years of age, to obtain a copy of the patient's immunization record through a Department authorized electronic Patient Portal;
  - ~~e.~~ To investigate vaccine fraud;
  - ~~ef.~~ To prevent, investigate, and control outbreaks of vaccine preventable communicable diseases;
  - ~~fg.~~ To conduct epidemiological studies;
  - ~~gh.~~ To provide data that does not identify an individual either directly or indirectly for research and only if the researcher submits a research protocol describing, at a minimum: the intended use of the data, the methodology of the research project; why access to the information is necessary, and approval by an official Institutional Review Board;
  - ~~hi.~~ To assure the quality of the data entered into the registry;
  - ~~ij.~~ To review the quality of the immunization practices of immunization providers;
  - ~~jk.~~ To publish aggregate data that does not identify an individual either directly or indirectly;
  - ~~kl.~~ When deemed necessary by the Director in the event of a disaster, state of emergency, or public health emergency;
  - ~~lm.~~ To perform repairs, maintenance, and updates of the Immunization registry;



~~mn.~~ To provide information needed by law enforcement officers and agencies in the investigation or prosecution of a crime;

~~no.~~ To implement this regulation, including compliance assistance and enforcement activities; and

p. To provide immunization records to health plans of members and enrollees of the health plan who received immunizations during the time in which they were enrolled in the health plan. Each immunization record shall be used by health plans for public health and Healthcare Effectiveness Data and Information Set (HEDIS) purposes only. Health plans shall enter into a data sharing agreement with the Department prior to receiving immunization records.

5. Uses and disclosures by immunization providers or authorized users of registry information not authorized by this section are prohibited. Nothing in this regulation authorizes an immunization provider or authorized user to make any use or disclosure of registry information that is otherwise prohibited by law.

#### FE. Compliance and Enforcement.

1. Immunization providers shall make immunization records available within a reasonable time to authorized representatives of the Department for inspection upon request.

2. For a violation of this regulation, the Department may:

a. Require an immunization provider or an authorized user to attend registry training;

b. Suspend or revoke access to the registry; or

c. Assess civil penalties as authorized by Section 44-1-150, S.C. Code of Laws, 1976, as amended.

3. A Department decision under Section ~~F-2E.2~~ may be appealed by an immunization provider or authorized user, pursuant to applicable law, including S.C. Code Title 44, Chapter 1 and Title 1, Chapter 23.

#### GF. Exceptions to Regulation.

1. The Department may grant a waiver to a requirement of this regulation, in its discretion when an immunization provider demonstrates to the Department's satisfaction that compliance would cause substantial hardship, that the waiver would protect and promote the health and safety of patients, and that the requirement is not specifically mandated by statute.

2. A delay in reporting caused by an act of God, war, strike, riot, or other catastrophe as to which negligence or willfulness on the part of the immunization provider was not the proximate cause will not be considered a violation of this regulation, as long as the immunization provider reports as required at the earliest practicable time after the event or catastrophe.

#### HG. Severability.

If a court of competent jurisdiction rules any part of this regulation invalid or otherwise unenforceable, the remaining portions of this regulation shall remain in effect as if the invalid portions were not originally a part of this regulation.

## ATTACHMENT B

### DEPARTMENT OF HEALTH AND ENVIRONMENTAL CONTROL CHAPTER 61

Statutory Authority: 1976 Code Section 44-29-40

#### **Notice of Drafting:**

The Department of Health and Environmental Control (“Department” or “DHEC”) proposes amending Regulation 61-120, South Carolina Immunization Registry. Interested persons may submit comments in writing to Stephen White, Immunization Division, Communicable Disease Prevention and Control, 2100 Bull Street, Columbia, S.C. 29201 or via email at [immunizationregulation@dhec.sc.gov](mailto:immunizationregulation@dhec.sc.gov). To be considered, comments must be received no later than 5:00 p.m. on May 28, 2018, the close of the draft comment period.

#### **Synopsis:**

The Department proposes amending R.61-120 to allow DHEC to provide specific Healthcare Effectiveness Data and Information Set (“HEDIS”) data from the South Carolina Immunization Registry (“Registry”) to health plans. HEDIS is a tool used by health plans to measure performance on important dimensions of care and service, including immunization data for clients. Proposed amendments to the regulation will also include: (1) details regarding the availability and use of a patient portal, which will be a feature of the new Registry allowing patients to access his or her immunization records; (2) clarifications pertaining to patient consent for the new patient portal; and (3) revisions to bring the regulation into conformity with updates and improvements to the Registry and advancements in public health practice.

The Department may also include stylistic changes, such as deletions of obsolete language, corrections for clarity and readability, grammar, punctuation, references, codification, and overall improvement of the text of the regulation.

General Assembly review is required.



(x) ACTION/DECISION  
( ) INFORMATION

Date: October 11, 2018

To: S.C. Board of Health and Environmental Control

From: Bureau of Environmental Health Services

**Re: Notice of Proposed Regulation Amending Regulation 61-25, *Retail Food Establishment* Repealing Regulation 61-37, *Retail Food Establishment Inspection Fees*.**

## I. Introduction

The Bureau of Environmental Health Services (“Bureau”) proposes the attached Notice of Proposed Regulation for amending R.61-25, *Retail Food Establishment Fees*, repealing Regulation 61-37, *Retail Food Establishment Inspection Fees*, amending and merging its requirements into R.61-25 for publication in the October 26, 2018, *South Carolina State Register*. Legal authority resides in S.C. Code Sections 44-1-140(2), 44-1-150, and 44-1-180, which allow the S.C. Department of Health and Environmental Control (“Department”) to make, adopt, promulgate, and enforce reasonable rules and regulations for the sanitation of all places or establishments providing eating or drinking facilities and all other places known as private nursing homes or places of similar nature, operated for gain or profit, and to charge fees. The Administrative Procedures Act, S.C. Code Section 1-23-120(A), requires General Assembly review of these amendments.

## II. Facts

1. The intent of R.61-25, *Retail Food Establishment Fees*, is to safeguard public health and provide consumers safe, unadulterated food and food products at the retail level. This regulation governs restaurants, grocery stores, school cafeterias, and other establishments where food is prepared and served to the public. R.61-25, *Retail Food Establishment Fees*, was last amended in 2014.
2. These amendments will allow the Department, through regulation, to meet the current standards of the 2017 United States Food and Drug Administration (“FDA”) Food Code. The FDA Food Code is the national standard for state, local, and tribal food protection programs. The FDA Food Code offers practical, science-based guidance that addresses the risk factors known to cause foodborne illness outbreaks in retail food establishment settings. It is amended every two (2) years and published in full every four (4) years by the national Conference for Food Protection, comprised of food safety regulators, food scientists, industry representatives, and members of academia.
3. The amendments also include proposed revisions to selected sections of Chapter 9 of R.61-25 to reflect the current business models of the food service industry based on comments and suggestions from the regulated community.
4. The amendments include combining R.61-25 with revised provisions of R.61-37, *Retail Food Establishment Inspection Fees*, was last amended in 2002. Specifically, the Bureau proposes revising fee schedules currently residing in R.61-37, placing the fee schedules in R.61-25, and combining the two regulations by repealing R.61-37. This would provide the retail food industry with one streamlined regulation while allowing for necessary program support through an increase in inspection fees.

5. The proposed amendments to R.61-25 also include other changes deemed necessary by the Department to improve the overall clarity, organization, and quality of the regulation. These proposed changes include, but are not limited to, stylistic changes, updates to definitions and exemptions, corrections for clarity, readability, grammar, punctuation, references, codification, and overall improvement of the text of the regulation.

6. The Department had a Notice of Drafting published in the August 24, 2018, *State Register* copy of the Notice of Drafting appears herein as Attachment B. The Department received no written public comments by the September 24, 2018, close of the public comment period.

7. The Bureau held a series of five (5) stakeholder meetings across the state in advance of the Notice of Drafting period. The Bureau sent email invitations to more than 19,000 permitted retail food establishments as well as interested trade associations and individuals. Additionally, meeting information was posted on the Department's food industry website. The following information shows the date, location, and attendance numbers for each meeting:

April 26, 2018, Columbia (40)  
April 27, 2018, Rock Hill (12)  
April 30, 2018, Greenville (76)  
May 2, 2018, Myrtle Beach (40)  
May 4, 2018, Mt. Pleasant (27)

Currently the Bureau is conducting another series of seven (7) stakeholder meetings across the state to gather input on the proposed revisions. The following indicates the date and location for each meeting:

October 3, 2018, Beaufort  
October 8, 2018, Greenville  
October 15, 2018, Florence (AM)  
October 15, 2018, Myrtle Beach (PM)  
October 17, 2018, Charleston  
October 29, 2018, Rock Hill  
October 31, 2018, Columbia

8. The Bureau incorporated verbal comments and suggestions from stakeholder meetings to date into the proposed regulatory text. Additional meetings were held with representatives of industry trade associations such as the S.C. Lodging and Restaurant Association and the other S.C. food safety agencies: the S.C. Department of Agriculture, Clemson Meat and Poultry Inspection Division, and the S.C. Department of Natural Resources. Suggestions from these additional meetings have been considered and incorporated where applicable.

9. Appropriate Department staff conducted an internal review of the proposed amendment and repeal on June 26, 2018.

### III. Request for Approval

The Bureau respectfully requests the Board grant approval of the attached Notice of Proposed Regulation for publication in the October 26, 2018, *State Register*.

  
Bureau Chief

  
Deputy Director

Attachments:

- A. Notice of Proposed Regulation
- B. Notice of Drafting published in the August 24, 2018, *State Register*

## ATTACHMENT A

### STATE REGISTER NOTICE OF PROPOSED REGULATION FOR REGULATION 61-25, *Retail Food Establishments* AND REGULATION 61-37, *Retail Food Establishment Inspection Fees*

October 11, 2018

Document No. \_\_\_\_\_

#### DEPARTMENT OF HEALTH AND ENVIRONMENTAL CONTROL CHAPTER 61

Statutory Authority: 1976 Code Sections 44-1-140(2), 44-1-150, and 44-1-180

61-25. Retail Food Establishments.

61-37. Retail Food Establishment Inspection Fees.

#### Preamble

The intent of R.61-25, Retail Food Establishments, is to safeguard public health and provide consumers safe, unadulterated food and food products at the retail level. This regulation governs restaurants, grocery stores, school cafeterias, and other establishments where food is prepared and served to the public. R.61-25 was last amended in 2014.

The proposed amendments herein will enable the Department of Health and Environmental Control (“Department”), through regulation, to meet the current standards of the 2017 United States Food and Drug Administration (“FDA”) Food Code. The FDA Food Code is the national standard for state, local, and tribal food protection programs. The FDA Food Code offers practical, science-based guidance that addresses the risk factors known to cause foodborne illness outbreaks in retail food establishment settings. It is amended every two (2) years and published in full every four (4) years by the national Conference for Food Protection, comprised of food safety regulators, food scientists, industry representatives, and members of academia.

These amendments also include proposed revisions to selected sections of Chapter 9 of R.61-25 to reflect the current business models of the food service industry based on comments and suggestions from the regulated community.

The amendments also include combining R.61-25 with revised provisions of R.61-37, Retail Food Establishment Inspection Fees, last amended in 2002. Specifically, the Department proposes revising fee schedules currently residing in R.61-37, placing the fee schedules in R.61-25, and combining the two regulations by repealing R.61-37, while allowing for necessary program support through an increase in inspection fees. This would provide the retail food industry with one streamlined regulation.

The proposed amendments to R.61-25 also include other changes as deemed necessary by the Department to improve the overall clarity, organization, and quality of the regulation. These changes include, but are not limited to, stylistic changes, updates to definitions and exemptions, corrections for clarity, readability, grammar, punctuation, references, and codification, and overall improvement of the text of the regulation.

The Administrative Procedures Act, S.C. Code Section 1-23-120(A), requires General Assembly review of these amendments.

The Department had a Notice of Drafting published in the August 24, 2018, South Carolina State Register.

#### Section-by-Section Discussion of Proposed Amendments and Repeal:

### **R.61-25**

In Chapters 1 through 9 of the proposed amendments to R.61-25, capitalization, punctuation, spelling, and grammatical errors have been corrected. The superscripts for Priority (P) and Priority Foundation (Pf), as found in the FDA Food Code, have been added to all relevant citations. The word “Section” has been added to references in all citations where it was missing for clarity. To improve readability, all subsection titles have been bolded. For brevity and space, these modifications are not listed.

### **In Contents**

Amended: All chapter titles were changed from all capitalization to capitalizing the first letter of each word for consistency.

Added: New section 4-303 “Cleaning Agents and Sanitizers.”

Renamed Sections 9-2 and 9-11 of Chapter 9 to more accurately fit the content of these revised sections.

### **In Chapter 1, Purpose and Definition, the following changes apply:**

#### Section 1-2

Deleted: (19) “Conditional employee,” as the term is not used in the regulation; renumbered remaining items.

Amended: (35) to add “work” to the description of a person under a contractual agreement.

Amended: (54) “Hermetically sealed container” to add the word “commercial” to conform to the Food Code.

Added: (58) “Intact meat” from the 2017 FDA Food Code.

Amended: (73) “Nuisance” to clarify that premises is included but not limited to the structure.

Amended: (79)(b) “Personal care items” to remove unnecessary wording of “and other such items”.

Amended: (106) “Retail food establishment” by changing “any” to “an” to match the intent of exemptions in Chapter 8-103.12(A) and by deleting “temporary food establishments” from the examples as they are not issued a retail food establishment permit.

Amended: (112) “Service animal” to clarify that the ADA service animal definition does not include “comfort animals” or any other type of support animal not recognized as a service animal under the ADA and its implementing regulations.

Amended: (117) to correct denotations of the E.coli strains listed.

Amended: (127)(b)(ii) Time/temperature control for safety food (TCS) Tables A and B to match the tables and wording in the 2017 FDA Food Code and include the term PA for product assessment.

Amended: (132)(a)(i) and (b)(i) to add “the violation of “ for clarity and that Priority and Priority Foundation violations are denoted in the body of the regulation with superscript of either “P” or “Pf.”

**In Chapter 2, Management and Personnel, the following changes apply:**

Section 2-1

Added: 2-102.11(C)(9) requiring knowledge of major allergens and renumbered remaining items.

Amended: 2-102.12 to add “and Food Handler Certification” to title.

Amended: 2-102.12(A) to add requirement for the certified food protection manager to be present at the facility frequently and to be responsible for ensuring employee health policies are implemented.

Added: 2-102.12(B) requiring that at all times during food service operations a person in charge with a Food Handler Certification be on duty and renumbered remaining items.

Added: 2-103.11(I) to supplement the duties of the person in charge from the 2017 FDA Food Code and renumbered remaining items.

Section 2-2

Amended: 2-201.11 Section title to add “Permit Holder.”

Amended: 2-201.11(A) to remove “person in charge” and replace with “permit holder.” Added that the food employee is to report illness to the person in charge.

Amended: 2-201.11(B)-(E) by striking existing (B) through (D) and replacing them with new (B) through (E) to conform to the 2017 FDA Food Code. This section provides guidance to industry on identification and reporting of illnesses.

Amended: 2-201.12 to add all of that section from the 2017 FDA Food Code not adopted from the 2013 FDA Food Code. This section provides clear guidance to industry on managing exclusion and restrictions of ill workers.

Added: 2-201.13 to conform to the 2017 FDA Food Code. This section provides clear guidance to industry on how to manage reinstating excluded and restricted ill workers.

Section 2-3

Amended: 2-203.11(A) to delete duplicative “on their hands and arms”.

Section 2-4

Added: 2-401.13 Use of Bandages, Finger Cots, or Finger Stalls from the 2017 FDA Food Code.

Amended: 2-402.11(A) to clarify when beard restraints are needed.

Amended: 2-403.11 to include 9-3 “Outdoor Pet Dining.”

#### Section 2-5

Amended: 2-501.11 to require that vomiting and diarrheal event clean-up procedures be in writing.

### **In Chapter 3, Food, the following changes apply:**

#### Section 3-2

Amended: 3-201.11(E)(2) to delete written buyer specifications as the new definition of “intact beef” now addresses this need.

Amended: 3-202.12 to correct the quoted CRF reference and delete “or Pesticide Residues” that is not part of the title of that section.

#### Section 3-3

Amended: 3-302.11(A) to correct reference from (c) to (d) and to add fruits and vegetables to the list of foods that must be separated from raw animal foods during storage, preparation, holding, and display.

#### Section 3-4

Amended: 3-304.11, 3-304.15 and 3-304.17 to add the word “Section” to references for clarity.

Amended: 3-401.11(A)(1)(b) to add “intact” description to “meat.”

Amended: 3-401.11(A)(2)-(3) to change required cooking time as per 2017 FDA Food Code.

Amended: 3-401.11(B)(1)-(2) to update language and the oven cooking Tables 3.2 and 3.3 to comport with the 2017 FDA Food Code.

Amended: 3-401.13 to change “fruits and vegetables” to the more inclusive “plant foods.”

Amended: 3-404.11(A) to reflect the entire section, not just (B)-(E).

#### Section 3-5

Added: 3-502.11(H) to clarify that a HACCP plan is not required for special processes that are for flavor enhancement only. A written statement must be provided indicating foods to be enhanced and food safety measures taken.

Amended: 3-502.12(B) to correct reference of (B) to (C).

Amended: 3-502.12(C) to add the requirement for a label indicating that fish must be kept frozen until time of use.

Amended: 3-502.12(D)(1) and (E)(2) to correct reference of (B) to (C).

#### Section 3-6

Added:3-602.11 (B)-(D).These provisions specify labeling requirements from the 2017 FDA Food Code providing for allergen labeling on packaged “grab and go” foods where there is no interaction with a server. Labeling will not apply to takeout or delivered food. The requirement allows the consumer to be aware of allergens present.

**In Chapter 4, Equipment, Utensils, and Linens, the following changes apply:**

Section 4-1

Amended: 4-101.17 to correct internal references, allow single use of cedar cooking planks, and move the allowance of wicker baskets when suitably lined to (F).

Section 4-2

Amended: 4-204.16 to change “shall not” to “may not.”

Section 4-3

Added:4-303.11.This is a new section on cleaning agents and sanitizers from the 2017 FDA Food Code. Clarifies that both must be present and available for use during operations.

Section 4-4

Amended: 4-402.11 to add “in place” to clarify the term “fixed”.

Amended: 4-501.114(F) to correct reference from (C) to (A)-(D).

Amended: 4-502.12 to add the word “Section” to reference for clarity.

Amended: 4-602.11(D)(2)(a)to add degrees to temperatures in chart.

Amended: 4-602.11(D)to add new subsections (4) and (6) on cleaning schedules previously not included. Clarifies when certain equipment must be cleaned.

Amended: 4-603.15(D)to add “in place” for clarity.

Amended: 4-903.11(A) and (D) to provide new allowance for storage of packaged food on pallets less than 6” off floor from the 2017 FDA Food Code.

**In Chapter 5, Water, Plumbing, and Waste, the following changes apply:**

Section 5-1

Amended: 5-103.11(B) to remove the requirement for separate hot water systems for food preparation areas to allow for more flexibility in system design. Hot water systems should meet the local plumbing requirements and are evaluated operationally by the Department.

Section 5-2

Amended: 5-202.14 to clarify that an internal to the building water supply backflow preventer needs to be ASSE certified.



Amended: 5-203.11 to clarify language that the number of handsinks required is related to the size and scope of the food service operation.

#### Section 5-3

Amended: 5-303.13 to correct the title to this subsection.

#### Section 5-4

Amended: 5-402.12 to add “areas” after food preparation in all references as needed for better clarity and readability.

#### Section 5-5

Amended: 5-501.111 to add “receptacles” to the requirement for clarity.

### **In Chapter 6, Physical Facilities, the following changes apply:**

#### Section 6-2

Amended: 6-202.14 by adding “or for a public access restroom, an alcove opening as approved by local building codes” to allow for the industry standard of using alcove openings and to harmonize with building codes.

Amended: 6-202.15(A)(3) by adding “tight-fitting” to the requirement for outer doors to comport with the current FDA Food Code.

Amended: 6-202.15(D) removed “temporary food establishment” as it was redundant to information in Section 9-8 Temporary Food Service Establishments.

### **In Chapter 7, Poisonous or Toxic Materials, the following changes apply:**

#### Section 7-2

Amended: 7-202.12(A)(2)-(4) to add certification requirements for pesticide applicators from the 2017 FDA Food Code at the request of S.C. pesticide regulators.

Amended: 7-204.12(A) to add clarification from the 2017 FDA Food Code regarding chemicals used in treatment, storage, and processing of fruits and vegetables.

Deleted: 7-204.12(B) to remove provision on the use of ozone as an antimicrobial agent to match deletion in 2017 FDA Food Code.

### **In Chapter 8, Compliance and Enforcement, the following changes apply:**

#### Section 8-2

Amended: 8-201.14, “contents of a HACCP plan” section, to include reorganizing existing language and adding clarified sections (A)-(C), (E), and (F) from 2017 FDA Food Code regarding the plan to be submitted and what needs to be submitted as part of the flow diagram and supporting documents.

Amended: 8-202.14(D)(4) added “each” before “critical control point” to provide clarity.

### Section 8-3

Amended: 8-301.12(A)(19) to clarify introductory language and by adding (g) to allow the Department to make risk-based decisions for permit exemptions for additional non-time/temperature control for safety foods that use a low-risk food process.

Added: 8-301.12(A)(20) to extend permit exemption to include individuals preparing and selling additional non-time temperature control for food safety foods (“cottage food” items such as jams/jellies/dried seasonings) from their homes and renumbered remaining items.

Amended: 8-301.12(A)(21) to remove restriction on using a blender to make single-serve smoothies with additional non-time temperature control for food safety food ingredients in (b) and to add new (g)-(h), exempting time-controlled waffle/funnel cake/mini donut mix for hotel breakfast service and roadside sale.

Amended: 8-301.12(A)(22) to delete “Vending machines” from (22) and moved them to new (23).

Added: 8-301.12(A)(23) to separately address exempt vending machines (moved from (22)).

Added: 8-301.12(C) to clarify that operations that are exempt from permit requirements are subject to the Department’s authority to investigate complaints as necessary to protect the public from food safety related health risk.

Amended: 8-302.13(D). As part of combining R.61-37 into this regulation, the Department has added a new \$100.00 fee for first-time permit/preoperational inspections in addition to the annual inspection fee.

Amended: 8-303.20(A)(1) through (A)(6) to reorganize and clarify how long the new owner has to make an application, pay fees, and achieve compliance at an inspection. This includes: deleting 8-303.20(A)(1)(a) and (A)(1)(b); adding a new paragraph (A)(2) and renumbering the following paragraphs; amending 8-303.20(A)(3)(b) to correct reference from 8-302.12 to 8-303.10; amending 8-303.20(A)(3)(c) to clarify when the facility will be deemed to be operating without a permit; amending 8-303.20(A)(4) to clarify that the Department will conduct an inspection to determine compliance after receiving a complete application; adding 8-303.20(A)(5) and (6), which clarify the implications of failing to submit a complete and timely application, pay fees, or obtain compliance at the permit inspection, and when the facility will be deemed operating without a permit; and renumbering remaining items.

Added: 8-304.11(A)(3). As part of combining R.61-37 into this regulation, added the fee renewal requirement and scale and other material information currently contained in R.61-37. The fee scale has been increased to provide for necessary support of the program.

Amended: 8-304.11(A)(4) to remove requirement to maintain a copy of the regulation and instead require access to and knowledge of the regulation.

Added: 8-304.11(A)(5) to require a facility to operate at least 15 consecutive days a year or one day a week for 15 weeks to retain its permit.

Added: 8-304.11(B)(8) to require the permit holder to notify the Department when the billing or mailing address changes.

Added: 8-304.11(B)(9) to require the permit holder to notify the Department of a change in the capacity of a shared use kitchen.

Amended: 8-304.11(C) to delete the word “also” for grammatical correctness.

Amended: 8-304.11(D) and (E) to update internal reference to “(B) and (C)” instead of “(A) and (B).”

#### Section 8-4

Amended: 8-402.20(C) to clarify that the Department may obtain a warrant if access is denied.

Amended: 8-402.40 to clarify Department enforcement options when a facility denies the Department access to the retail food establishment.

Amended: 8-403.10(E) to prohibit covering, obscuring, defacing, relocating, or removing the posted food grade.

Amended: 8-405.11 (A)(3) and (C)(4) added “from the date of the inspection” to provide clarity of when follow up would occur.

Added: 8-404.11(F) from 2017 FDA Food Code allowing a facility to continue to operate in emergency situations if it has a written emergency operating plan approved by the Department.

Amended: 8-405.11(A)(1) and (A)(3) to clarify that the ten(10)-day period is from the date of the inspection.

Amended: 8-405.11(A)(2) to require all core violations, regardless of grade, to be corrected as soon as possible.

#### Section 8-5

Amended: 8-501.20 to remove references to conditional employees as they are not addressed in other parts of the regulation.

#### Section 8-7

Deleted: 8-701.11 “Implementation of Regulations,” as none of the proposed additions will require delayed implementation, and all previously delayed items are now in regulatory effect.

#### Section 8-9

Amended: 8-904 to correct the title to read “Permit Suspension.”

Amended: 8-904.10 to correct the title to read “Conditions Warranting Summary Suspension.”

Amended: 8-904.30 to correct the title to read “Contents of the Summary Suspension Notice.”

Amended: 8-904.50 to correct the title to read “Term of Summary Suspension, Reinstatement of Permit.”

Amended: 8-904.110(A)(5) to clarify the Department's authority to suspend a facility's permit for failure to notify the Department of facility changes.

Amended: 8-904.110(A)(7) to add "obscuring" to current wording.

Amended: 8-904.110(A)(9) to clarify the Department's authority to suspend a permit upon a facility's failure to pay a civil penalty required by a Department order.

Amended: 8-904.110(A)(10) by adding new language to reflect the requirement to operate for fifteen (15) consecutive days annually or at least one (1) day every week for at least fifteen (15) weeks and renumbered existing (10) to (11).

Added: 8-904.110(B)(6) to authorize the Department to revoke a facility's permit upon a failure to operate as a retail food establishment at least fifteen (15) consecutive days annually or at least one (1) day a week for fifteen (15) weeks.

Amended: 8-904.120 to distinguish notice requirements of ordinary suspensions from those of summary suspensions.

Amended: 8-913.10 to clarify the Department's authority to impose civil penalties for violation of an order of the Department.

**Chapter 9, Standards for Additional Retail Food Establishment Operations, the following apply:**

Deleted: References to thermometer scales in requirements for thermometers in all sections.

Section 9-1

Amended: (A)(1) Mobile food establishment definition to add that a mobile food unit can be a watercraft and is movable or portable.

Amended: (A)(2) commissary definition to provide that a retail food establishment that serves a highly susceptible population and is regulated by the Department as a health care facility may not be used as a commissary.

Amended: (B)(3) to remove the requirement for daily return to commissary and storage at commissary; added new requirements (a)-(c) to allow for up to seventy-two (72) hours of operation before servicing for fully self-contained units and to allow Department approval of alternative storage locations for all types of units.

Amended: (F)(1)(b)(i) Service window size requirement so that windows can be configured as needed but no bigger than 576 inches square.

Amended: (H)(5) to align hot water requirement with 5-103.11.

Added: (H)(6) to allow for units to hook up to a public water supply on a temporary basis at location provided that they can also hook up to approved wastewater disposal system. This provision supports the allowance for longer times between servicing at commissary.

Amended: (I)(3) to delete "only" and to add "or approved sewage disposal site."

Amended: (K)(2) to clarify enclosure exemption is for units that serve only commercially, fully cooked, TCS foods that only require heating, not cooking.

Deleted: (K)(3) to remove exemption from CFPM requirements for mobile pushcarts. Mobile units will comply with Food Handler section of 2-102.12 or be exempted under 2-102.20 (B), depending on menu.

Deleted: (L)(8)(a) to delete requirement for drawings and renumbered remainder of section.

Amended: (L)(12) to delete the lettering size requirement, delete the requirement to print the commissary name and permit number, and require that signage must be conspicuous to the consumer as a replacement for these requirements.

### Section 9-2

Amended: Section title to read “Meat/Meat Product and Fish/Fish Product Sales” and made corresponding changes to all subsections. This allows for broader use of this section for roadside meat/fish sales and removes any requirement to inspect vehicles for any other type of food transport or storage unit not subject to Department regulatory authority. Clarified that this section applies to the transportation of meat and fish products from source to point of sale.

Amended: (C)(1) to clarify that ice must be obtained from approved sources.

Amended: (C)(7) to clarify language pertaining to temperature measuring during transport.

Amended: (D) to clarify the subsection title and requirements related to refrigeration.

### Section 9-3

Amended: (D)(3) and (D)(4) to change “exclusive” to “exclusively used” for clarity.

Amended: (D)(6) to add that the waste container needs to be in the outdoor pet dining area and used exclusively for storing pet waste.

Amended: (E)(1) to require that signs shall be posted at all dining entrances stating that the facility is pet friendly and has an outdoor pet friendly dining area.

Amended: (E)(6) to remove restriction allowing pets on chairs and to change the restriction to apply to food contact surfaces.

### Section 9-5

Amended: (A)(1) to add that a retail food establishment that serves a highly susceptible population and is regulated by the Department as a health care facility may not be used as a shared use operation.

Added: (B)(1) to move duties of the facilitator from (C)(1)(a) to the general section to clarify that it is applicable to the entire section.

Amended: (C) and (D) to combine sections (C) “Permits” and (D) “Compliance” into a single section titled “Compliance” to be consistent with other Chapter 9 sections.

Amended: (C)(1)(a) to remove language moved to (B)(1), to require the facilitator to provide the number of shared use operators the facility can accommodate and to require that the shared use operation will not exceed this number of operators without Department notification.

#### Section 9-6

Amended: (G)(2) to change “meet” to “have at” for readability and clarity.

#### Section 9-7

Amended: The introduction to add that the standard is applicable to a smokehouse room.

#### Section 9-8

Amended: (A) to add “movie or filming location” to the list of allowed events.

Added: (E)(7)-(8) to require that food must be kept covered and that covers or lids may only be removed for stirring and similar actions.

Amended: (H)(3) changed “backsiphonage” to “backflow” to match term used in Chapter 5 for consistency.

Deleted: (J)(3). The reference to mechanical ventilation is not required as it was an unnecessary statement.

Amended: (K)(7) to correct error in section references in (K)(7) and renamed section 9-11.

#### Section 9-9

Added: (D)(13)-(14) to require that food must be kept covered and that covers or lids may only be removed for stirring and similar actions.

Amended: (G)(3) changed “backsiphonage” to “backflow” to match term used in Chapter 5 for consistency.

Deleted: (I)(4). The reference to mechanical ventilation is not required as it was an unnecessary statement.

#### Section 9-10

Amended: (G)(3) changed “backsiphonage” to “backflow” to match term used in Chapter 5 for consistency.

Deleted: (I)(4). The reference to mechanical ventilation is not required as it was an unnecessary statement. Renumbered remaining subparagraph.

#### Section 9-11

Amended: Section title to read “Retail Food Establishment – South Carolina Farmers Markets, Seasonal Series and Remote Service” to allow this section to cover other types of events and activities not previously covered by the regulation. Made corresponding changes to introduction.

Added: (A)(3) to define “remote service operation.”

Amended: (B)(1) to add remote service sites.

Amended: (B)(3)-(4) to expand the number of days a week allowed for these functions to two days a week to accommodate the schedules of the farmers’ markets and similar events.

Added: (D)(9)-(10) to require food must be kept covered and that covers or lids may only be removed for stirring and similar actions.

Amended: (F)(1) to remove requirement for markets to provide a handsink and changed handsink requirements to match Chapter 9-9 and 9-10 facilities that operate for the same time period.

Added: (F)(1)(a)-(b) as part of handsink clarification requirements.

Amended: (F)(2) to remove requirement for one hundred (100)-degree Fahrenheit temperature water at handwashing facility and to require handwashing facility to be of adequate storage capacity to meet the demand of the food service operation.

Amended: (F)(3) to delete specific water storage requirements and replace them with requirement for soap and disposable towels.

Amended: (H) Title to include “and Refuse Removal” to accurately reflect the section.

Deleted: (I)(1) to remove the exemption from CFPM for seasonal series and community-based farmers’ markets as the revised Food Handler requirements in the body of the regulation cover these operations.

Deleted: (I)(3). The reference to mechanical ventilation is not required as it was an unnecessary statement.

Amended: (J)(1) to add that remote service does not require pre-approval authorization.

## **R.61-37**

**R.61-37 is repealed and stricken in its entirety, as its amended requirements are being moved into R.61-25, Chapter 8.**

### **Notice of Public Hearing and Opportunity for Public Comment:**

Interested persons may submit written comment(s) on the proposed amendment and repeal by mail to Sandra D. Craig, Director, Division of Food and Lead Risk Assessments in the Bureau of Environmental Health Services at the S.C. Department of Health and Environmental Control, 2600 Bull Street, Columbia, S.C. 29201; fax at 803-896-0645; or email at [craigsd@dhec.sc.gov](mailto:craigsd@dhec.sc.gov). To be considered, the Department must receive the comment(s) by 5:00 p.m. on November 26, 2018, the close of the comment period.

The S.C. Board of Health and Environmental Control will conduct a public hearing on the proposed amendment and repeal during its December 13, 2018, 10:00 a.m. meeting. Interested persons may make oral and/or submit written comments at the public hearing. Persons making oral comments should limit

their statements to five (5) minutes or less. The meeting will take place in the Board Room of the DHEC Building, located at 2600 Bull Street, Columbia, S.C. 29201. Due to admittance procedures, all visitors must enter through the main Bull Street entrance and register at the front desk. The Department will publish a meeting agenda twenty-four (24) hours in advance indicating the order of its scheduled items at: <http://www.scdhec.gov/Agency/docs/AGENDA.PDF>.

The Department publishes a Monthly Regulation Development Update tracking the status of its proposed new regulations, amendments, and repeals and providing links to associated State Register documents at <http://www.scdhec.gov/Agency/RegulationsAndUpdates/RegulationDevelopmentUpdate/>.

## **Preliminary Fiscal Impact Statement**

There are no anticipated new costs to the state or its political subdivisions associated with the implementation of this regulation.

## **Statement of Need and Reasonableness**

The following presents an analysis of the factors listed in 1976 Code Section 1-23-115(C)(1)-(3) and (9)-(11):

DESCRIPTION OF REGULATION: 61-25, Retail Food Establishments, and 61-37, Retail Food Establishment Inspection Fees.

Purpose: This amendment strikes the text of the existing R.61-37, Retail Food Establishment Inspection Fees, in total and amends R.61-25, Retail Food Establishments, to incorporate revised fee schedules currently residing in R.61-37, as well as to meet the current standards of the 2017 United States Food and Drug Administration (“FDA”) Food Code. The FDA Food Code is the national standard for state, local, and tribal food protection programs. The FDA Food Code offers a practical, scientifically-sound technical and legal basis for regulating the retail food establishment segment of the food industry by addressing the risk factors known to cause foodborne illness outbreaks in retail food establishment settings. The amendments include proposed revisions to selected sections of Chapter 9 of R.61-25 to reflect the current business models of the food service industry and incorporate comments and suggestions from the regulated community. The amendments also include other changes as deemed necessary by the Department to improve the overall clarity, organization, and quality of the regulation. These changes include, but are not limited to, stylistic changes, updates to definitions and exemptions, corrections for clarity, readability, grammar, punctuation, references, codification, and overall improvement of the text of the regulation.

Legal Authority: 1976 Code Sections 44-1-140(2), 44-1-150, and 44-1-180

Plan for Implementation: The DHEC Regulation Development Update (accessible at <http://www.scdhec.gov/Agency/RegulationsAndUpdates/RegulationDevelopmentUpdate/>) provides a summary of and link to this proposed amendment and repeal. Additionally, printed copies are available for a fee from the Department’s Freedom of Information Office. Upon taking legal effect, Department personnel will take appropriate steps to inform the regulated community of the amendment/repeal and any associated information.

DETERMINATION OF NEED AND REASONABLENESS OF THE PROPOSED REGULATION BASED ON ALL FACTORS HEREIN AND EXPECTED BENEFITS:



The proposed amendments will allow the Department, through regulation, to meet the current standards of the 2017 United States Food and Drug Administration (“FDA”) Food Code. The FDA Food Code is the national standard for state, local, and tribal food protection programs. The FDA Food Code offers practical, science-based guidance that addresses the risk factors known to cause foodborne illness outbreaks in retail food establishment settings. It is amended every two (2) years and published in full every four (4) years via the Conference for Food Protection, a national conference of food safety regulators, food scientists, industry representatives, and members of academia.

The proposed amendments also revise Chapter 9 of the regulation to reflect current business models within the food service industry.

The proposed amendments also incorporate an increase in inspection fees, which will provide necessary program support. The proposed amendments merge R.61-37 into R.61-25 to provide the retail food industry with one streamlined regulation.

The proposed amendments also include other changes as deemed necessary by the Department to improve the overall clarity, organization, and quality of the regulation.

#### DETERMINATION OF COSTS AND BENEFITS:

The proposed amendments seek to benefit food safety in South Carolina and the health of South Carolina’s citizens, as the intent of this regulation is to provide consumers with safe, unadulterated food and food products at the retail level. The amendment of R.61-25 will allow the regulation to conform to the current national standard set by the 2017 FDA Food Code. For the food service industry, including many establishments associated with national chains, the current edition of the FDA Food Code provides a needed uniformity and consistency with food safety rules nationally. Other proposed changes to the regulation improve the overall clarity, organization, quality, and consistency of the regulation, which benefits the public and regulated community by facilitating improved understanding and implementation of the regulation.

The proposed increase in fees will benefit the Bureau of Environmental Health Services (“Bureau”) and ease the burden on the general public by facilitating additional program support through increasing existing fees instead of requesting additional state taxpayer funding. The additional funds will generate more resources to fund Department development and provision of compliance assistance tools and training for the regulated community to support facilities in developing practical food safety systems for their operations.

The proposed fee increase is based on the Bureau's review of comparable regional food safety programs and evaluation of program needs due to retail food service industry growth. Existing program fees were established in 2000 and have not increased since such time. The following proposed fee changes would both ensure fees for South Carolina facilities remain in keeping with fees charged by other southeastern states and also generate much needed funds for the Bureau's permit and inspection programs. Under the proposed regulation, the base annual inspection fee of sixty dollars (\$60.00) would be increased to one hundred dollars (\$100.00). As proposed, the annual inspection fee increases by increments of fifty dollars (\$50.00) per tier up to a maximum inspection fee of four hundred and fifty dollars (\$450.00), as compared to increments of thirty dollars (\$30.00) per tier up to a maximum inspection fee of two hundred and seventy dollars (\$270.00) under the current regulation. To meet the growing demands for service and inspection, the Department also proposes an increase to the initial permitting fee to include a one-time fee of one hundred dollars (\$100.00) in addition to the applicable tiered annual inspection fee. This increased fee will support the cost of conducting pre-operational and permit inspections.

## UNCERTAINTIES OF ESTIMATES:

None

## EFFECT ON THE ENVIRONMENT AND PUBLIC HEALTH:

Implementation of this regulation will not compromise the protection of the environment or the public health. The proposed regulation will help to ensure that consumers are receiving safe, unadulterated food and food products at the retail level. The amendment of R.61-25 to conform to the most recent edition of the FDA Food Code also provides effective means of reducing the risks of foodborne illnesses within retail food establishments, thus protecting consumers and industry from potentially devastating public health consequences and financial losses.

## DETRIMENTAL EFFECT ON THE ENVIRONMENT AND PUBLIC HEALTH IF THE REGULATION IS NOT IMPLEMENTED:

There will be no adverse effect on the environment if the regulations are not implemented. Not implementing these regulations could have detrimental effect on public health. Not implementing these regulations will prevent the implementation of the latest sanitary standards and will impede the comprehensive approach to food safety management needed in addressing food protection in the retail food industry. This could have a detrimental effect on the health of South Carolina's citizens and visitors. Failure to provide the necessary fee funding for the program may result in a decrease in effectiveness of the food safety oversight program as the industry continues to expand in size. The lack of increased fee funding also reduces Department compliance assistance resources for the regulated industry.

## Statement of Rationale:

These amendments provide the retail food industry the regulatory framework to meet the latest sanitation requirements for providing safe, unadulterated food and food products to consumers. The FDA Food Code offers proven scientific reasons behind regulation and actively seeks input from the scientific and academic communities as their understanding of foodborne pathogens increases. The amendment of R.61-25 to conform to the most recent edition of the FDA Food Code provides a comprehensive approach to food safety management, superior supporting documents and training, and is consistent with the national integrated food safety management system. Furthermore, the R.61-25 amendments and R.61-37 repeal provide the retail food industry with one streamlined regulation while allowing for necessary program support through an increase in inspection fees. The proposed revisions to Chapter 9 of the regulation are intended to better reflect current business models within the food service industry. Other proposed changes to the regulation improve the overall clarity, organization, and quality, of the regulation.

## Text:

~~Indicates Matter Stricken~~  
Indicates New Matter

61-25. Retail Food Establishments.

Statutory Authority: 1976 Code Sections 44-1-140(2), 44-1-150, and 44-1-180

## CONTENTS

CHAPTER 1 Purpose and ~~DEFINITIONS~~Definitions

CHAPTER 2	<del>MANAGEMENT AND PERSONNEL</del>	Management and Personnel
CHAPTER 3	<del>FOOD</del>	Food
CHAPTER 4	<del>EQUIPMENT, UTENSILS, AND LINENS</del>	Equipment, Utensils, and Linens
CHAPTER 5	<del>WATER, PLUMBING, AND WASTE</del>	Water, Plumbing, and Waste
CHAPTER 6	<del>PHYSICAL FACILITIES</del>	Physical Facilities
CHAPTER 7	<del>POISONOUS OR TOXIC MATERIALS</del>	Poisonous or Toxic Materials
CHAPTER 8	<del>COMPLIANCE AND ENFORCEMENT</del>	Compliance and Enforcement
CHAPTER 9	<del>STANDARDS FOR ADDITIONAL RETAIL FOOD ESTABLISHMENT OPERATIONS</del>	Standards for Additional Retail Food Establishment Operations

## **Chapter Purpose and Definitions**

### **1-1 Title, Intent, Scope**

- 1-101 Title
- 1-102 Intent
- 1-103 Scope

### **1-2 Definitions**

- 1-201 Applicability and Terms Defined

## **Chapter Management and Personnel**

### **2-1 Supervision**

- 2-101 Responsibility
- 2-102 Knowledge
- 2-103 Duties

### **2-2 Employee Health**

- 2-201 Responsibilities of Permit Holder, Person in Charge, and Food Employees

### **2-3 Personal Cleanliness**

- 2-301 Hands and Arms
- 2-302 Fingernails
- 2-303 Jewelry
- 2-304 Outer Clothing

### **2-4 Hygienic Practices**

- 2-401 Food Contamination Prevention
- 2-402 Hair Restraints
- 2-403 Animals

### **2-5 Responding to Contamination Events**

- 2-501 Procedures for Responding

## **Chapter 3 Food**

### **3-1 Characteristics**

3-101 Condition

### **3-2 Sources, Specifications, and Original Containers and Records**

3-201 Sources

3-202 Specifications for Receiving

3-203 Original Containers and Records

### **3-3 Protection from Contamination after Receiving**

3-301 Preventing Contamination by Employees

3-302 Preventing Food and Ingredient Contamination

3-303 Preventing Contamination from Ice Used as a Coolant

3-304 Preventing Contamination from Equipment, Utensils, and Linens

3-305 Preventing Contamination from the Premises

3-306 Preventing Contamination by Consumers

3-307 Preventing Contamination from Other Sources

### **3-4 Destruction of Organisms of Public Health Concern**

3-401 Cooking

3-402 Freezing

3-403 Reheating

3-404 Other Methods

### **3-5 Limitation of Growth of Organisms of Public Health Concern**

3-501 Temperature and Time Control

3-502 Specialized Processing Methods

### **3-6 Food Identity, Presentation, and On-premises Labeling**

3-601 Accurate Representation

3-602 Labeling

3-603 Consumer Advisory

### **3-7 ~~Contamination~~Contaminated Food**

3-701 Disposition

### **3-8 Special Requirements for Highly Susceptible Populations**

3-801 Additional Safeguards

## **Chapter 4 Equipment, Utensils, and Linens**

### **4-1 Materials for Construction and Repair**

- 4-101 Multiuse
- 4-102 Single-Service and Single-Use

## **4-2 Design and Construction**

- 4-201 Durability and Strength
- 4-202 Cleanability
- 4-203 Accuracy
- 4-204 Functionality
- 4-205 Acceptability

## **4-3 Numbers and Capacities**

- 4-301 Equipment
- 4-302 Utensils, Temperature Measuring Devices, and Testing Devices
- 4-303 Cleaning Agents and Sanitizers

## **4-4 Location and Installation**

- 4-401 Location
- 4-402 Installation

## **4-5 Maintenance and Operation**

- 4-501 Equipment
- 4-502 Utensils and Temperature and Pressure Measuring Devices

## **4-6 Cleaning of Equipment and Utensils**

- 4-601 Objective
- 4-602 Frequency
- 4-603 Methods

## **4-7 Sanitization of Equipment and Utensils**

- 4-701 Objective
- 4-702 Frequency
- 4-703 Methods

## **4-8 Laundering**

- 4-801 Objective
- 4-802 Frequency
- 4-803 Methods

## **4-9 Protection of Clean Items**

- 4-901 Drying
- 4-902 Lubricating and Reassembling
- 4-903 Storing

4-904 Preventing Contamination

## **Chapter 5 Water, Plumbing, and Waste**

### **5-1 Water**

- 5-101 Source
- 5-102 Quality
- 5-103 Quantity and Availability
- 5-104 Distribution, Delivery, and Retention

### **5-2 Plumbing System**

- 5-201 Materials
- 5-202 Design, Construction, and Installation
- 5-203 Numbers and Capacities
- 5-204 Location and Placement
- 5-205 Operation and Maintenance

### **5-3 Mobile Water Tank and Mobile Food Establishment Water Tank**

- 5-301 Materials
- 5-302 Design and Construction
- 5-303 Numbers and Capacities
- 5-304 Operations and Maintenance

### **5-4 Sewage, Other Liquid Waste, and Rainwater**

- 5-401 Mobile Holding Tank
- 5-402 Retention, Drainage, and Delivery
- 5-403 Disposal Facility

### **5-5 Refuse, Recyclables, and Returnables**

- 5-501 Facilities on the Premises
- 5-502 Removal
- 5-503 Facilities for Disposal and Recycling

## **Chapter 6 Physical Facilities**

### **6-1 Materials for Construction, and Repair**

- 6-101 Indoor Areas
- 6-102 Outdoor Areas

### **6-2 Design, Construction, and Installation**

- 6-201 Cleanability
- 6-202 Functionality

### **6-3 Numbers and Capacities**

- 6-301 Handwashing Sinks
- 6-302 Toilet and Urinals
- 6-303 Lighting
- 6-304 Ventilation
- 6-305 Dressing Areas and Lockers
- 6-306 Service Sinks

#### **6-4 Location and Placement**

- 6-401 Handwashing Sinks
- 6-402 Toilet Rooms
- 6-403 Employee Accommodations
- 6-404 Distressed Merchandise
- 6-405 Refuse, Recyclables, and Returnables

#### **6-5 Maintenance and Operation**

- 6-501 Premises, Structures, Attachments, and Fixtures – Methods

### **Chapter Poisonous or Toxic Materials**

#### **7-1 Labeling and Identification**

- 7-101 Original Containers
- 7-102 Working Containers

#### **7-2 Operational Supplies and Applications**

- 7-201 Storage
- 7-202 Presence and Use
- 7-203 Container Prohibitions
- 7-204 Chemicals
- 7-205 Lubricants
- 7-206 Pesticides
- 7-207 Medicines
- 7-208 First Aid Supplies
- 7-209 Other Personal Care Items

#### **7-3 Stock and Retail Sale**

- 7-301 Storage and Display

### **Chapter Compliance and Enforcement**

#### **8-1 Regulation Applicability**

- 8-101 Use for Intended Purpose
- 8-102 Additional Requirements
- 8-103 Variances

## **8-2 Plan Submission and Approval**

- 8-201 Operating Plans
- 8-203 Construction Inspection and Approval

## **8-3 Permit to Operate**

- 8-301 Requirement
- 8-302 Application Procedure
- 8-303 Issuance
- 8-304 Conditions of Retention

## **8-4 Inspection and Correction of Violations**

- 8-402 Access
- 8-403 Report of Findings
- 8-404 Imminent Health Hazard
- 8-405 Correction of Violations

## **8-5 Prevention of Foodborne Disease Transmission by Employees**

- 8-501 Investigation and Control

## **8-6 Constitutional Protection**

- 8-602 Judicial Review

## **8-7 Authority**

- 8-701 Legal Authority

## **8-9 Remedies**

### **Administrative**

- 8-903 Holding, Examination, and Destruction of Food
- 8-904 Summary Permit Suspension
- 8-905 Appeals

### **Judicial**

- 8-913 Civil Penalties

## **Chapter Standards for Additional Retail Food Establishment Operations**

### 9-1 ~~MOBILE FOOD~~ **Mobile Food**

### 9-2 ~~TRANSPORTATION AND SALES OF MEAT/MEAT PRODUCTS, SEAFOOD AND FISH~~ **Meat/Meat Product/Fish Product Sales**

### 9-3 ~~OUTDOOR PET DINING~~ **Outdoor Pet Dining**



- 9-4 ~~WILD MUSHROOM FORAGING~~ **Wild Mushroom Foraging**
- 9-5 ~~SHARED USE OPERATIONS~~ **Shared Use Operations**
- 9-6 ~~IMMEDIATE OUTDOOR COOKING~~ **Immediate Outdoor Cooking**
- 9-7 ~~BARBECUE PIT AND PIT COOKING ROOM CONSTRUCTION~~ **Barbecue Pit and Pit-Cooking Room Construction**
- 9-8 ~~TEMPORARY FOOD SERVICE ESTABLISHMENTS~~ **Temporary Food Service Establishments**
- 9-9 ~~COMMUNITY FESTIVALS~~ **Community Festivals**
- 9-10 ~~SPECIAL PROMOTIONS~~ **Special Promotions**
- 9-11 ~~SOUTH CAROLINA FARMERS MARKET AND SEASONAL SERIES~~ **Retail Food Establishment - South Carolina Farmers Markets, Seasonal Series and Remote Service**

## **Chapter Purpose and Definitions**

### **1-1 TITLE, INTENT, SCOPE**

#### **1-101 Title**

~~1-101.10 Regulation 61-25.~~ **1-101.10 Regulation 61-25.**

These provisions shall be known as Regulation 61-25, hereinafter referred to as “this Regulation.”

#### **1-102 Intent**

~~1-102.10 Food Safety, Illness Prevention, and Honest Presentation~~ **1-102.10 Food Safety, Illness Prevention, and Honest Presentation.**

The purpose of this Regulation is to safeguard public health and provide to consumers food that is safe, unadulterated, and honestly presented.

#### **1-103 Scope**

~~1-103.10 Statement~~ **1-103.10 Statement.**

This Regulation establishes definitions; sets standards for management and personnel, food operations, equipment and facilities; and provides for retail food establishment permit issuance, inspection, employment restriction, permit suspension and revocation.

### **1-2 DEFINITIONS**

#### **1-201 Applicability and Terms Defined.**

~~1-201.10 Statement of Application and Listing of Terms.~~ **1-201.10 Statement of Application and Listing of Terms.**

(A) The following definitions shall apply in the interpretation and application of this Regulation.

(B) Terms Defined. As used in this Regulation, each of the terms listed in 1-201.10(B) shall have the meanings stated below.

(1) **Accredited Program.**

(a) **"Accredited program"** is a food protection manager certification program that has been evaluated and listed by an accrediting agency as conforming to national standards for organizations that certify individuals.

(b) **"Accredited program"** refers to the certification process and is a designation based upon an independent evaluation of factors such as the sponsor's mission, organizational structure, staff resources, revenue sources, policies, public information regarding program scope, eligibility requirements, re-certification, discipline and grievance procedures, and test development and administration.

(c) **"Accredited program"** not refer to training functions or educational programs.

(2) **Additives.**

(a) **"Food additive"** the meaning stated in the *Federal Food, Drug, and Cosmetic Act* Section 201(s) and 21 CFR 170.3(e)(1).

(b) **"Color additive"** the meaning stated in the *Federal Food, Drug, and Cosmetic Act* Section 201(t) and 21 CFR 70.3(f).

(3) **"Adulterated"** means to make food unsafe for human consumption by any means, including, but not limited to, the addition of a foreign or inferior substance or food that has violated a critical limit.

(4) **"Approved"** means acceptable to the Department based on a determination of conformity with principles, practices, and generally recognized standards that protect public health.

(5) **"*A<sub>w</sub>*"** means a symbol for water activity, which measures the free moisture in a food. It is the quotient of water vapor pressure of the substance divided by the vapor pressure of pure water at the same temperature.

(6) **"Balut"** means an embryo inside a fertile egg that has been incubated for a period sufficient for the embryo to reach a specific stage of development after which it is removed from incubation before hatching.

(7) **"Beverage"** means a liquid for drinking, including water.

(8) **"Boarding house"** means a private residence in which lodgers rent one or more rooms for extended periods of time, usually weeks, months or years. The common parts of the house are maintained, and some services, such as laundry and cleaning, may be supplied. They normally provide "bed and board" which will include some meals as well as accommodation.

(9) **"Bottled drinking water"** means water that is sealed in bottles, packages, or other containers and offered for sale for human consumption, including bottled mineral water.

(10) **"Casing"** means a tubular container for sausage products made of either natural or artificial (synthetic) material.

(11) **"Certification number"** means a unique combination of letters and numbers assigned by a shellfish control authority to a molluscan shellfish dealer according to the provisions of the National Shellfish Sanitation Program.

(12) **"CFR"** means Code of Federal Regulations. Citations in this regulation to the CFR refer sequentially to the Title, Part, and Section numbers such as 40 CFR 180.194 refers to Title 40, Part 180, Section 194.

(13) **CIP.**

(a) **"CIP"** means cleaned in place by the circulation or flowing by mechanical means through a piping system of a detergent solution, water rinse, and sanitizing solution onto or over equipment surfaces that require cleaning, such as the method used, in part, to clean and sanitize a frozen dessert machine.

(b) **"CIP"** does not include the cleaning of equipment such as band saws, slicers, or mixers that are subjected to in-place manual cleaning without the use of a CIP system.

(14) **"Commingle"** means:

(a) To combine shellstock harvested on different days or from different growing areas as identified on the tag or label, or

(b) To combine shucked shellfish from containers with different container codes or different shucking dates.

(15) **Comminuted.**

(a) **"Comminuted"** means reduced in size by methods including chopping, flaking, grinding, or mincing.

(b) **"Comminuted"** includes fish or meat products that are reduced in size and restructured or reformulated such as gefilte fish, gyros, ground beef, and sausage, and a mixture of two (2) or more types of meat that have been reduced in size and combined.

(16) **"Commissary"** means a permitted retail food establishment that is authorized by the Department to provide a servicing area for mobile food unit or mobile food pushcarts for the purposes of storage of food, supplies, and single-service articles. The commissary supports the following operations:

(a) Food preparation.

(b) Equipment and utensil washing.

(c) Disposal of sewage and solid waste.

(d) Obtainment of potable water.

(e) Provides a mobile food unit or mobile food pushcarts servicing and storage area.

(17) **"Community-based farmers market"** market sponsored by a community or governmental organization either having been certified by the ~~South Carolina~~SC Department of Agriculture as a SC Certified Farmer's Market or a farmers market that meets the definition of the Farmers Market Coalition which states, "A farmers market operates multiple times per year and is organized for the purpose of facilitating personal connections that create mutual benefits for local farmers, shoppers, and communities and implements rule or guidelines of operation that ensure that the farmers market consists principally of farms selling directly to the public products that the farms have produced."

(18) **"Community festivals"** events sponsored by a community group, city/county/state organization, as a community celebration, that are generally theme related, and have multiple food vendors recruited to provide food to the public for a time period not to exceed three (3) consecutive days or no more than seventy-two (72) continuous hours. Each community festival is unique and will not be held more frequently than annually, although a sponsoring organization or group might have multiple but differently themed community festivals in a year.

~~(19) "Conditional employee" a potential food employee to whom a job offer is made, conditional on responses to subsequent medical questions or examinations designed to identify potential food employees who may be suffering from a disease that can be transmitted through food and done in compliance with Title I of the Americans with Disabilities Act of 1990~~

~~(20)~~ **"Consumer"** means a person who is a member of the public, takes possession of food, is not functioning in the capacity of an operator of a retail food establishment or food processing plant, and does not offer the food for resale.

(240) **"Core violation"** (132) "Violations."

(221) **"Corrosion-resistant materials"** material that maintains acceptable surface cleanability characteristics under prolonged influence of the food to be contacted, the normal use of cleaning compounds and sanitizing solutions, and other conditions of the use environment.

(232) **"Counter-mounted equipment"** equipment that is not portable and is designed to be mounted off the floor on a table, counter, or shelf.

(243) **"Critical control points"** a point or procedure in a specific food system where loss of control may result in an unacceptable health risk.

(254) **"Critical limit"** means the maximum or minimum value to which a physical, biological, or chemical parameter must be controlled at a critical control point to minimize the risk that the identified food safety hazard may occur.

(265) **"Cut leafy greens"** means fresh leafy greens whose leaves have been further cut, shredded, sliced, chopped, or torn, beyond any cut made to harvest intact leaves from a plant. The term "cut leafy greens" does not apply to leaves harvested intact from a plant. The term "leafy greens" includes iceberg lettuce, romaine lettuce, leafy-lettuce, butter lettuce, baby leaf lettuce (i.e., immature lettuce or leafy greens), escarole, endive, spring mix, spinach, cabbage, kale, arugula, and chard. The term "leafy greens" does not include herbs such as cilantro or parsley.

(276) **"Dealer"** means a person who is authorized by a shellfish control authority for the activities of shellstock shipper, shucker-packer, repacker, reshipper, or depuration processor of molluscan shellfish according to the provisions of the National Shellfish Sanitation Program.

(287) **"Department"** means the South Carolina Department of Health and Environmental Control or agents thereof having responsibility for enforcing these regulations.

(298) **"Disclosure"** means a written statement that clearly identifies the animal-derived foods which are, or can be ordered, raw, undercooked, or without otherwise being processed to eliminate pathogens; or items that contain an ingredient that is raw, undercooked, or without otherwise being processed to eliminate pathogens.

(3029) **Drinking Water.**

(a) **"Drinking water"** means water that meets criteria as specified in 40 CFR 141, *National Primary Drinking Water Regulations* 141.51-58, *State Primary Drinking Water Regulation*

(b) **"Drinking water"** traditionally known as "potable water."

(c) **"Drinking water"** includes the term "water" except where the term used connotes that the water is not potable, such as "boiler water," "mop water," "rainwater," "wastewater," and "non-drinking" water.

(340) **"Dry storage area"** means a room or area designated for the storage of packaged or containerized bulk food that is not time/temperature control for safety food and dry goods such as single-service items.

(321) **Easily cleanable.**

(a) **"Easily cleanable"** means a characteristic of a surface that:

(i) Allows effective removal of soil by normal cleaning methods;

(ii) Is dependent on the material, design, construction, and installation of the surface; and

(iii) Varies with the likelihood of the surface's role in introducing pathogenic or toxigenic agents or other contaminants into food based on the surface's approved placement, purpose, and use.

(b) **"Easily cleanable"** includes a tiered application of the criteria that qualify the surface as easily cleanable as specified in (a) of this definition to different situations in which varying degrees of cleanability are required such as:

(i) The appropriateness of stainless steel for a food preparation surface as opposed to the lack of need for stainless steel to be used for floors or for tables used for consumer dining; or

(ii) The need for a different degree of cleanability for a utilitarian attachment or accessory in the kitchen as opposed to a decorative attachment or accessory in the consumer dining area.

(332) **"Easily movable"** means:

(a) Portable; mounted on casters, gliders, or rollers; or provided with a mechanical means to safely tilt a unit of equipment for cleaning; and

(b) Having no utility connection, a utility connection that disconnects quickly, or a flexible utility connection line of sufficient length to allow the equipment to be moved for cleaning of the equipment and adjacent area.

(343) **Egg.**

(a) **"Egg"** means the shell egg of an avian species such as chicken, duck, goose, guinea, quail, ratites or turkey.

(b) **"Egg"** does not include:

(i) A Balut;

(ii) The egg of reptile species such as alligator; or

(iii) An egg product.

(354) **Egg product**

(a) **"Egg Product"** means all, or a portion of, the contents found inside eggs separated from the shell and pasteurized in a food processing plant, with or without added ingredients, intended for human consumption, such as dried, frozen, or liquid eggs.

(b) **"Egg Product"** does not include food which contains eggs only in a relatively small proportion such as cake mixes.

(365) **"Employee"** means the permit holder, person in charge, food employee, person having supervisory or managerial duties, person on the payroll, family member, volunteer, person performing work under a contractual agreement, or any other person working in a retail food establishment.

(376) **"EPA"** means the U.S. Environmental Protection Agency.

(387) **Equipment.**

(a) **"Equipment"** means an article that is used in the operation of a retail food establishment such as a freezer, grinders, hood, ice makers, meat block, mixer, oven, reach-in refrigerators, scale, sinks, slicer, stove, table temperature measuring device for ambient air, or warewashing machine.

(b) **"Equipment"** does not include apparatuses used for handling or storing large quantities of packaged foods that are received from a supplier in a cased or overwrapped lot, such as hand trucks, forklifts, dollies, pallets, racks, and skids.

(398) **"Exclude"** means to prevent a person from working as an employee in a retail food establishment or entering a retail food establishment as an employee.

(4039) **"FDA"** means the U. S. Food and Drug Administration.

(440) **Fish.**

(a) **"Fish"** means fresh or saltwater finfish, crustaceans and other forms of aquatic life (including alligator, frog, aquatic turtle, jellyfish, sea cucumber, and sea urchin and the roe of such animals) other than birds or mammals, and all mollusks, if such animal life is intended for human consumption.

(b) **"Fish"** includes an edible human food product derived in whole or in part from fish, including fish that have been processed in any manner.

(421) **"Food"** means a raw, cooked, or processed edible substance, ice, beverage, or ingredient used or intended for use or for sale in whole or in part for human consumption.

(432) **"Foodborne disease outbreak"** means the occurrence of two or more cases of a similar illness resulting from the ingestion of a common food.

(443) **"Food-contact surface"**:

(a) A surface of equipment or a utensil with which food normally comes into contact; or

(b) A surface of equipment or a utensil from which food may drain, drip, or splash:

(i) Into a food, or

(ii) Onto a surface normally in contact with food.

(454) **"Food employee"** means an individual working with unpackaged food, food equipment or utensils, or food-contact surfaces.

(465) **Food processing plant.**

(a) "Food processing plant" means a commercial operation that manufactures, packages, labels, or stores food for human consumption, and provides food for sale or distribution to other business entities such as food processing plants or retail food establishments.

(b) "Food processing plant" does not include a retail food establishment.

(476) **Game animal.**

(a) **"Game animal"** means an animal, the products of which are food, that is not classified as livestock, sheep, swine, goat, horse, mule, or other equine in 9 CFR 301.2, *Definitions*, as poultry or fish.

(b) **"Game animal"** includes mammals such as reindeer, elk, deer, antelope, water buffalo, bison, rabbit, squirrel, opossum, raccoon, nutria, or muskrat, and nonaquatic reptiles such as land snakes.

(c) **"Game animal"** does not include ratites.

(487) **"General use pesticide"** means a pesticide that is not classified by EPA for restricted use as specified in 40 CFR 152.175, *Pesticides Classified For Restricted Use*

(498) **"Grade A standards"** to milk that meets the requirements of the United States Public Health Service/FDA *Grade A Pasteurized Milk Ordinance* which certain fluid and dry milk and milk products comply or the requirements of the Department's R.61-34, *Raw Milk for Human Consumption*

(5049) **"Grade decal"** means an official decal issued by the Department that is posted by the Department in a retail food establishment, or on a mobile food unit or a mobile food pushcart that is representative of the most recent inspection.

(540) **"HACCP (Hazard Analysis and Critical Control Point) plan"** means a written document that delineates the formal procedures for following the Hazard Analysis and Critical Control Point principles developed by the National Advisory Committee on Microbiological Criteria for Foods.

(521) **Handwashing sink**

(a) **"Handwashing sink"** means a lavatory, a basin for handwashing, or a plumbing fixture specifically placed for use in personal hygiene and designed for the washing of the hands.

(b) **"Handwashing sink"** includes an automatic handwashing facility.

(532) **"Hazard"** means a biological, chemical, or physical property that may cause an unacceptable consumer health risk.

(543) **"Health practitioner"** means a physician licensed to practice medicine, or if allowed by law, a nurse practitioner, physician assistant, or similar medical professional.

(554) **"Hermetically sealed container"** means a container that is designed and intended to be secure against the entry of microorganisms and, in the case of low acid canned food, is able to maintain the commercial sterility of its contents after processing.

(565) **"Highly susceptible population"** means persons who are more likely than other people in the general population to experience foodborne disease because they are:

(a) Immunocompromised; preschool age children; or older adults; and

(b) Obtaining food at a facility that provides services such as: custodial care, health care, or assisted living, such as a child or adult day care center, kidney dialysis center, hospital or nursing home, or nutritional or socialization services such as a senior center.

(576) **"Imminent health hazard"** means a significant threat or danger to health that is considered to exist when there is evidence sufficient to show that a product, practice, circumstance, or event creates a situation that requires immediate correction or cessation of operation to prevent illness or injury based on:

(a) The number of potential illnesses or injuries, and

(b) The nature, severity, and duration of the anticipated illness or injury.

(587) **"Injected"** means manipulating meat to which a solution has been introduced into its interior by processes that are referred to as "injecting," "pump marinating," or "stitch pumping."



(58) **"Intact Meat"** means a cut of whole muscle(s) meat that has not undergone comminution, injection, mechanical tenderization, or reconstruction.

(59) **Juice**

(a) **"Juice"** means the aqueous liquid expressed or extracted from one or more fruits, or vegetables, ~~purees~~ purées of the edible portions of one or more fruits or vegetables, or any concentrates of such liquid or purée.

(b) **"Juice"** does not include, for purposes of HACCP, liquids, purées, or concentrates that are not used as beverages or ingredients of beverages.

(60) **"Kitchenware"** means food preparation and storage utensils.

(61) **"Law"** means applicable local, state, and federal statutes, regulations, and ordinances.

(62) **"Linens"** means fabric items such as cloth hampers, cloth napkins, tablecloths, wiping cloths, and work garments including cloth gloves.

(63) **"Low-risk food processes"** means food processes that have been determined and approved by the Department to be low risk. The Department will evaluate low-risk food processes based on food items, food handling and preparation, and foodborne illness.

(64) **Major Food Allergen**

(a) **"Major food allergens"** are:

(i) Milk, egg, fish (such as bass, flounder, cod, and including crustacean shellfish such as crab, lobster, or shrimp), tree nuts (such as almonds, pecans, or walnuts), wheat, peanuts, and soybeans; or

(ii) A food ingredient that contains protein derived from a food, as specified in (1)(a)(i) of this definition.

(b) **"Major food allergen"** not include:

(i) Any highly refined oil derived from a food specified in (a)(i) of this definition and any ingredient derived from such highly refined oil; or

(ii) Any ingredient that is exempt under the petition or notification process specified in the *Food Allergen Labeling and Consumer Protection Act of 2004* (Pub. Law 108-282).

(65) **"Meat"** means the flesh of animals used as food including the dressed flesh of cattle, swine, sheep, goats, or other edible animals, except fish, poultry, and game animals as specified under 3-201.17(A)(3) and (4).

(66) **Mechanically tenderized.**

(a) **"Mechanically tenderized"** means manipulating meat with deep penetration by processes which may be referred to as "blade tenderizing," "jaccarding," "pinning," "needling," or using blades, pins, needles or any mechanical device.

(b) **"Mechanically tenderized"** does not include processes by which solutions are injected into meat.

(67) **"mg/L"** means milligrams per liter, which is the metric equivalent of parts per million (ppm).

(68) **"Mobile food establishment"** means a retail food establishment that consists of a commissary and mobile food units or mobile food pushcarts.

(69) **"Mobile food unit"** means fully enclosed mobile kitchens that prepare, cook, or serve time/temperature control for safety food as an extension of a commissary.

(70) **"Mobile food pushcart"** means limited food service units that operate as an extension of a commissary.

(71) **"Molluscan shellfish"** means any edible species of fresh or frozen oysters, clams, mussels, and scallops or edible portions thereof, except when the scallop product consists only of the shucked adductor muscle.

(72) **Non-continuous cooking.**

(a) **"Non-continuous cooking"** means the cooking of food in a retail food establishment using a process in which the initial heating of the food is intentionally halted so that it may be cooled and held for complete cooking at a later time prior to sale or service.

(b) **"Non-continuous cooking"** does not include cooking procedures that only involve temporarily interrupting or slowing an otherwise continuous cooking process.

(73) **"Nuisance"** for the purpose of this Regulation is a public health nuisance and means whatever is dangerous to human life or detrimental to health, including but not limited to whatever structure or premises is not sufficiently ventilated, sewerred, drained, cleaned, or lighted with respect to its intended occupancy.

(74) **Packaged.**

(a) **"Packaged"** means bottled, canned, cartoned, bagged, or wrapped, whether packaged in a retail food establishment or a food processing plant.

(b) **"Packaged"** does not include wrapped or placed in a carry-out container to protect the food during service or delivery to the consumer by a food employee, upon consumer request.

(75) **"Permit"** means the document issued by the Department that authorizes a person or entity to operate a retail food establishment.

(76) **"Permit holder"** means the entity that:

(a) Is legally responsible for the operation of the retail food establishment such as the owner, the owner's agent, or other person; and

(b) Possesses a valid permit to operate a retail food establishment.

(77) **"Person"** means an association, a corporation, individual, partnership, other legal entity, government, or governmental subdivision or agency.

(78) **"Person in charge"** means the individual present at a retail food establishment who is responsible for the operation at the time of inspection.

(79) **Personal care items.**

(a) **"Personal care items"** items or substances that may be poisonous, toxic, or a source of contamination and are used to maintain or enhance a person's health, hygiene, or appearance.

(b) **"Personal care items"** items such as medicines, first aid supplies, and other items such as cosmetics, and toiletries such as toothpaste and mouthwash.

(80) **"pH"** means the symbol for the negative logarithm of the hydrogen ion concentration, which it is a measure of the degree of the acidity or alkalinity of a solution. Values between zero (0) and seven (7.0) indicate acidity and values between seven (7.0) and fourteen (14.0) indicate alkalinity. The value for pure distilled water is seven (7.0), which is considered neutral.

(81) **"Physical facilities"** means the structure and interior surfaces of a retail food establishment including accessories such as soap and towel dispensers and attachments such as light fixtures and heating or air conditioning system vents.

(82) **"Plumbing fixture"** means a receptacle or device that:

(a) Is permanently or temporarily connected to the water distribution system of the premises and demands a supply of water from the system; or

(b) Discharges used water, waste materials, or sewage directly or indirectly to the drainage system of the premises.

(83) **"Plumbing system"** means the water supply and distribution pipes; plumbing fixtures and traps; soil, waste, and vent pipes; sanitary and storm sewers and building drains, including their respective connections, devices, and appurtenances within the premises; and water-treating equipment.

(84) **"Poisonous or toxic materials"** means substances that are not intended for ingestion and are included in 4 categories:

(a) Cleaners and sanitizers, which include cleaning and sanitizing agents and agents such as caustics, acids, drying agents, polishes, and other chemicals;

(b) Pesticides, except sanitizers, which include substances such as insecticides and rodenticides;

(c) Substances necessary for the operation and maintenance of the retail food establishment such as nonfood grade lubricants and personal care items that may be deleterious to health; and

(d) Substances that are not necessary for the operation and maintenance of the retail food establishment and are on the premises for retail sale, such as petroleum products and paints.

(85) **"Poultry"** means:

(a) Any domesticated bird (chickens, turkeys, ducks, geese, guineas, ratites, or squabs), whether live or dead, as defined in 9 CFR 381.1, *Poultry Products Inspection Regulations Definitions, Poultry* and

(b) Any migratory waterfowl or game bird, pheasant, partridge, quail, grouse, or pigeon, whether live or dead, as defined in 9 CFR 362.1, *Voluntary Poultry Inspection Regulations, Definitions*.

(86) **“Premises”** means:

(a) The physical facility, its contents, its land, and any adjacent or bordering contiguous land or property under the control of the permit holder; or

(b) The physical facility, its contents, and land or property not described in (a) of this definition if its facilities, contents, or land that are under the control of the permit holder and may impact the retail food establishment personnel, facilities, or operations, and the retail food establishment is only one component of a larger operation such as a healthcare facility, hotel, motel, school, recreational camp, or prison.

(87) **“Pre-operational inspection”** means an inspection conducted by the Department, to determine compliance with the regulation for the purpose of obtaining a permit.

(88) **“Primal cut”** means a basic major cut into which carcasses and sides of meat are separated, - such as a beef round, pork loin, lamb flank, or veal breast.

(89) **Priority violation** (132) “Violations.”

(90) **Priority foundation violation** (132) “Violations.”

(91) **“Private residence”** is a domestic home or dwelling in which food is prepared or served for individual and family consumption. A private residence is exempt from compliance with this regulation.

(92) **“Process authority”** is a qualified person(s) approved by the Department ~~having~~ have expert knowledge and adequate facilities to assess and determine safe food handling and processing requirements, including but not limited to thermal processing requirements in hermetically sealed containers, reduced oxygen packaging, shelf stable non-time/temperature control for safety foods, and cooking processes.

(93) **“Product assessment”** a process by which a retail food establishment submits food to be tested at a lab approved by Department to determine if the food is time/temperature control for safety or non-time/temperature control for safety. A product assessment shall test intrinsic and extrinsic factors necessary to determine if the food is capable of supporting the growth or toxic formation of pathogenic microorganisms.

(94) **“Public water system”** the meaning stated in 40 CFR 141, *National Primary Drinking Water Regulations* R.61-58, *State Primary Drinking Water Regulation*

(95) **“Ratite”** means a flightless bird such as an emu, ostrich, or rhea.

(96) **“Raw milk”** refers to milk that has not been pasteurized and that is approved for sale and human consumption in South Carolina under the Department’s R.61-34, *Raw Milk for Human Consumption*.

(97) **Ready-to-Eat Food.**

(a) **“Ready-to-eat food”** is food that:

(i) Is in a form that is edible without additional preparation to achieve food safety, as specified under one of the following: 3-401.11(A) or (B), 3-401.12, or 3-402.11, or as specified in 3-401.11(C); or

(ii) Is a raw or partially cooked animal food and the consumer is advised as specified in 3-401.11(D)(1) and (3); or

(iii) Is prepared in accordance with a variance that is granted as specified in 3-401.11(D) (4); and

(iv) May receive additional preparation for palatability or aesthetic, epicurean, gastronomic, or culinary purposes.

(b) **“Ready-to-eat food”** includes:

(i) Raw animal food that is cooked as specified under 3-401.11 or 3-401.12, or frozen as specified under 3-402.11;

(ii) Raw fruits and vegetables that are washed as specified under 3-302.15;

(iii) Fruits and vegetables that are cooked for hot holding, as specified under 3-401.13;

(iv) All time/temperature control for safety food that is cooked to the temperature and time required for the specific food under 3-401 and cooled as specified under 3-501.14;

(v) Plant food for which further washing, cooking, or other processing is not required for food safety; and from which rinds, peels, husks, or shells, if naturally present, are removed;

(vi) Substances derived from plants such as spices, seasonings, and sugar;

(vii) A bakery item such as bread, cakes, pies, fillings, or icing for which further cooking is not required for food safety;

(viii) The following products that are produced in accordance with USDA guidelines and that have received a lethality treatment for pathogens: dry, fermented sausages, such as dry salami or pepperoni; salt-cured meat and poultry products, such as prosciutto ham, country cured ham, and Parma ham; and dried meat and poultry products, such as jerky or beef sticks; and

(ix) Foods manufactured as specified in 21 CFR Part 113, *Thermally Processed Low-Acid Foods Packaged in Hermetically Sealed Containers*.

(98) **Reduced Oxygen Packaging.**

(a) **“Reduced oxygen packaging”**

(i) The reduction of the amount of oxygen in a package by removing oxygen; displacing oxygen and replacing it with another gas or combination of gases; or otherwise controlling the oxygen content to a level below that normally found in the atmosphere (approximately twenty one (21) percent at sea level); and

(ii) A process as specified in (a)(i) of this definition that involves a food for which the hazards *Clostridium botulinum* and *Listeria monocytogenes* are under control in the final packaged form.

(b) **“Reduced oxygen packaging”**

(i) Vacuum packaging, in which air is removed from a package of food and the package is hermetically sealed so that a vacuum remains inside the package;

(ii) Modified atmosphere packaging, in which the atmosphere of a package of food is modified so that its composition is different from air but the atmosphere may change over time due to the permeability of the packaging material or the respiration of the food. Modified atmosphere packaging includes reduction in the proportion of oxygen, total replacement of oxygen, or an increase in the proportion of other gases such as carbon dioxide or nitrogen;

(iii) Controlled atmosphere packaging, in which the atmosphere of a package of food is modified so that until the package is opened, its composition is different from air, and continuous control of that atmosphere is maintained, such as by using oxygen scavengers or a combination of total replacement of oxygen, nonrespiring food, and impermeable packaging material;

(iv) Cook chill packaging, in which cooked food is hot filled into impermeable bags which have the air expelled and are then sealed or crimped closed. The bagged food is rapidly chilled and refrigerated at temperatures that inhibit the growth of psychrotrophic pathogens; or

(v) Sous vide packaging, in which raw or partially cooked food is vacuum packaged in an impermeable bag, cooked in the bag, rapidly chilled, and refrigerated at temperatures that inhibit the growth of psychrotrophic pathogens.

(99) **“Refuse”** means solid waste not carried by water through the sewage system.

(100) **“Regulation”** refers to Regulation 61-25.

(101) **“Reminder”** means a written statement concerning the health risk of consuming animal foods raw, undercooked, or without otherwise being processed to eliminate pathogens.

(102) **“Re-service”** means the transfer of food that is unused and returned by a consumer after being served or sold and in the possession of the consumer, to another person.

(103) **“Restrict”** means to limit the activities of a food employee so that there is no risk of transmitting a disease that is transmissible through food, and the food employee does not work with exposed food, clean equipment, utensils, linens, or unwrapped single-service or single-use articles.

(104) **“Restricted egg”** means any check, dirty egg, incubator reject, inedible, leaker, or loss as defined in 9 CFR 590.

(105) **"Restricted use pesticide"** means a pesticide product that contains the active ingredients specified in 40 CFR 152.175, *Pesticides Classified For Restricted Use*, that is limited to use by or under the direct supervision of a certified applicator.

(106) **"Retail food establishment"** means any operation that prepares, processes, packages, serves, or otherwise provides food for human consumption, either on or off the premises, regardless of whether there is a charge for the food. These establishments include, but are not limited to, restaurants, delicatessens, snack bars, catering operations, ice cream parlors, school cafeterias, independent living food service operations, licensed healthcare facilities, ~~temporary food establishments~~, grocery stores, retail meat markets, fish/seafood markets, retail ice merchants, shared use operations, and mobile food establishments (to include the associated commissary and mobile units).

(107) **"Risk"** means the likelihood that an adverse health effect will occur within a population as a result of a hazard in a food.

(108) **"Safe material"** means:

(a) An article manufactured from or composed of materials that may not reasonably be expected to result, directly or indirectly, in their becoming a component or otherwise affecting the characteristics of any food.

(b) An additive that is used as specified in 409 of the *Federal Food, Drug, and Cosmetic Act* or

(c) Other materials that are not additives and that are used in conformity with applicable regulations of the Food and Drug Administration.

(109) **"Sanitization"** means the application of cumulative heat or chemicals on cleaned food-contact surfaces that, when evaluated for efficacy, is sufficient to yield a reduction of 5 logs, which is equal to a 99.999 percent reduction, of representative disease microorganisms of public health importance.

(110) **"Sealed"** means free of cracks or other openings, that allow the entry or passage of moisture.

(111) **"Seasonal series"** means a regularly occurring event sponsored by a community or governmental organization for promoting local business, culture, or other local specialties.

(112) **"Service animal"** means an animal such as a guide dog, signal dog, or other animal individually trained to provide assistance to an individual with a disability as per the *Americans for Disabilities Act*. Service animal does not include emotional, comfort, or similar support animals not recognized under the Americans with Disabilities Act (ADA) regulations as service animals.

(113) **"Servicing area"** means an operating base location to which a mobile food establishment or transportation vehicle returns regularly for such things as vehicle and equipment cleaning, discharging liquid or solid wastes, refilling water tanks and ice bins, and boarding food.

(114) **"Sewage"** means liquid waste containing animal or vegetable matter in suspension or solution and may include liquids containing chemicals in solution.

(115) **"Shellfish control authority"** a state, federal, foreign, tribal, or other government entity legally responsible for administering a program that includes certification of molluscan shellfish harvesters and dealers for interstate commerce.

(116) **"Shellstock"** means raw in-shell molluscan shellfish.

(117) **"Shiga toxin-producing *Escherichia coli*" (STEC)** means any *E. coli* capable of producing Shiga toxins (also called verocytotoxins). STEC infections can be asymptomatic or may result in a spectrum of illness ranging from mild non-bloody diarrhea, to hemorrhagic colitis (i.e., bloody diarrhea), to hemolytic uremic syndrome (HUS - a type of kidney failure). Examples of serotypes of STEC include: *E. coli* O157:H7, *E. coli* O26:H11, *E. coli* O145:H28, *E. coli* O103:H2 and *E. coli* O111:NM. STEC are sometimes referred to as VTEC (**verocytotoxigenic *E. coli***) or as EHEC (**Enterohemorrhagic *E. coli***). EHEC are a subset of STEC which can cause hemorrhagic colitis or HUS.

(118) **"Shucked shellfish"** means molluscan shellfish that have one of both shells removed.

(119) **"Single-service articles"** tableware, carry-out utensils, and other items such as bags, containers, placemats, stirrers, straws, toothpicks, and wrappers that are designed and constructed for one time, one person use after which they are intended for discard.

(120) **Single-use articles.**

(a) **"Single-use articles"** utensils and bulk food containers designed and constructed to be used once and discarded.

(b) **"Single-use articles"** food packaging and other items such as wax paper, butcher paper, plastic wrap, formed aluminum food containers, jars, plastic tubs or buckets, bread wrappers, pickle barrels, ketchup bottles, and number 10 (ten) cans which do not meet the materials, durability, strength, and cleanability specifications under 4-101.11, 4-201.11, and 4-202.11 for multiuse utensils.

(121) **"Slacking"** means the process of moderating the temperature of a food such as, allowing a food to gradually increase from a temperature of -10 degrees F (-23 degrees C) to 25 degrees F (-4 degrees C) in preparation for deep-fat frying or to facilitate even heat penetration during the cooking process of previously block-frozen food such as shrimp.

(122) **"Smooth"** means:

(a) A food-contact surface having a surface free of pits and inclusions with a cleanability equal to or exceeding that of one hundred (100) grit number 3 (three) stainless steel;

(b) A non-food-contact surface of equipment having a surface equal to that of commercial grade hot-rolled steel free of visible scale; and

(c) A floor, wall, or ceiling having an even or level surface with no roughness or projections that renders it difficult to clean.

(123) **"Standard Operating Procedures (SOPs)"** means established or prescribed methods to be followed for the performance of designated operations or in designated situations as determined by the Department.



(124) **“Tableware”** means eating, drinking, and serving utensils for table use such as flatware including forks, knives, spoons; hollowware including bowls, cups, serving dishes, tumblers, and plates.

(125) **“Temperature measuring device”** thermometer, thermocouple, thermistor, or other device that indicates the temperature of food, air, or water.

(126) **“Temporary food establishment”** establishment that may be authorized by the Department to operate at a fixed location for a period of time not to exceed fourteen (14) consecutive days in connection with a fair, carnival, circus, trade show, golf, or other national sporting events and other transitory gatherings organized by the community.

(127) **Time/temperature control for safety food** (or “potentially hazardous food” (PHF)).

(a) **“Time/temperature control for safety food”** that requires time/temperature control for safety (TCS) to limit pathogenic microorganism growth or toxin formation.

(b) **“Time/temperature control for safety food”**

(i) An animal food that is raw or heat-treated; a plant food that is heat-treated or consists of raw seed sprouts, cut melons, cut leafy greens, cut tomatoes, or mixtures of cut tomatoes that are not modified in a way so that they are unable to support pathogenic microorganism growth or toxin formation, or garlic-in-oil mixtures that are not modified in a way so that they are unable to support pathogenic microorganism growth or toxin formation; and

(ii) Except as specified in (c)(iv) of this definition, a food that because of the interaction of its Aw and pH values is designated as Product Assessment Required (PA) in Table (A) or (B) of this definition:

<b>Table A. Interaction of pH and Aw for control of spores in food heat-treated vegetative cells and subsequently packaged.</b>			
Aw values	pH values		
	pH: 4.6 or less	pH: Greater than 4.6 5.6	pH: Greater than 5.6
Less than or equal to 0.92	non-TCS Food*	non-TCS Food	non-TCS Food
Greater than 0.92-0.95	non-TCS Food	non-TCS Food	TCS Food <u>PA</u> **
Greater than 0.95	non-TCS Food	TCS Food <u>PA</u>	TCS Food <u>PA</u>
* TCS Food means Time/Temperature Control For Safety Food			
** Foods at these interaction values are considered TCS unless a Product Assessment, pursuant to 3-502 documents that foods are shelf stable and non-TCS. <u>PA</u> means Product Assessment required			

<b>Table B. Interaction of pH and Aw for control of vegetative cells and spores heat-treated or heat treated but not packaged.</b>
--

Aw values	pH values			
	pH: Less than 4.2	pH: 4.2 - 4.6	pH: Greater than 4.6 - 5.0	pH: Greater than 5.0
Less than 0.88	non-TCS Food*	non-TCS Food	non-TCS Food	non-TCS
0.88 - 0.90	non-TCS	non-TCS	non-TCS Food	TCS Food <del>PA</del> **
Greater than 0.90 - 0.92	non-TCS	non-TCS	TCS Food <del>PA</del>	TCS Food <del>PA</del>
Greater than 0.92	non-TCS	TCS Food <del>PA</del>	TCS Food <del>PA</del>	TCS Food <del>PA</del>
* TCS Food means Time/Temperature Control For Safety Food				
** <del>Foods at these interaction values are considered TCS unless a Product Assessment, pursuant to 3-502 documents that foods are shelf stable and non-TCS.</del> PA means Product Assessment required				

(c) **"Time/temperature control for safety food"** include:

(i) An air-cooled hard-boiled egg with shell intact, or an egg with shell that is not hard-boiled, but has been pasteurized to destroy all viable *Salmonell*~~æ~~

(ii) A food in an unopened hermetically sealed container that is commercially processed to achieve and maintain commercial sterility under conditions of non-refrigerated storage and distribution;

(iii) A food that because of its pH or Aw value, or interaction of Aw and pH values, is designated as a non-TCS food in Table A or B of this definition;

(iv) A food that is designated TCS\* and a product assessment (PA) required in Table A or B of this definition and has undergone a product assessment showing that the growth or toxin formation of pathogenic microorganisms that are reasonably likely to occur in that food is precluded due to:

(aa) Intrinsic factors including added or natural characteristics of the food such as preservatives, antimicrobials, humectants, acidulants, or nutrients;

(bb) Extrinsic factors including environmental or operational factors that affect the food such as packaging, modified atmospheric such as reduced oxygen packaging, shelf life and use, or temperature range of storage and use; or

(cc) A combination of intrinsic and extrinsic factors; or

(v) A food that does not support the growth or toxin formation of pathogenic microorganisms in accordance with one of the (c)(i) through (c)(iv) of this definition even though the food may contain a pathogenic microorganism or chemical or physical contaminant at a level sufficient to cause illness or injury.

(128) **"USDA"** means the U.S. Department of Agriculture.

(129) **"Utensil"** means a food-contact implement or container used in the storage, preparation, transportation, dispensing, sale, or service of food, such as kitchenware or tableware that is multiuse,

single-service, or single-use; gloves used in contact with food; temperature-sensing probes of food temperature measuring devices; and probe-type price or identification tags used in contact with food.

(130) **“Variance”** means a written document issued by the Department that authorizes a modification or waiver of one or more requirements of this regulation if, in the opinion of the Department, a health hazard or nuisance will not result from the modification or waiver.

(131) **“Vending machine”** means a self-service device that, upon insertion of a coin, paper currency, token, card, or key, or by optional manual operation, dispenses unit servings of food in bulk or in packages without the necessity of replenishing the device between each vending operation.

(132) **Violations.**

(a) **Priority violation.**

(i) **“Priority violation”** means the violation of a provision in this Regulation whose application contributes directly to the elimination, prevention or reduction to an acceptable level, hazards associated with foodborne illness or injury and there is no other provision that more directly controls the hazard. Priority violations are denoted in this regulation by the superscript “P”.

(ii) **“Priority violation”** includes violations with a quantifiable measure to show control of hazards such as cooking, reheating, cooling, handwashing.

(b) **Priority Foundation violation.**

(i) **“Priority foundation violation”** means the violation of a provision in this Regulation whose application supports, facilitates or enables one or more priority violations. Priority foundation violations are denoted in this regulation by the superscript “Pf”.

(ii) **“Priority foundation violation”** is a violation that requires the purposeful incorporation of specific actions, equipment or procedures by industry management to attain control of risk factors that contribute to foodborne illness or injury such as personnel training, infrastructure or necessary equipment, HACCP plans, documentation or record keeping, and labeling.

(c) **Core violation.**

(i) **“Core violation”** means the violation of a provision in this Regulation that is not designated as a priority item or a priority foundation violation.

(ii) **“Core violation”** includes a violation that usually relates to general sanitation, operational controls, sanitation standard operating procedures (SSOPs), facilities or structures, equipment design, or general maintenance.

(d) **“Consecutive violation”** is a priority or priority foundation or core violation that was recorded on routine or complaint inspection(s), and is recorded on consecutive routine or complaint inspection(s). Consecutive violations are the same violation citation and similar in nature.

(133) **“Warewashing”** means the cleaning and sanitizing of food-contact surfaces of equipment and utensils.

(134) **“Whole-muscle, intact beef”** Whole muscle beef that is not injected, mechanically tenderized, reconstructed, or scored and marinated, from which beef steaks may be cut.

## **Chapter Management and Personnel**

### **2-1 SUPERVISION**

#### **2-101 Responsibility**

##### ~~2-101.11 Assignment.~~ **2-101.11 Assignment.**

(A) Except as specified in (B) of this section, the permit holder shall be the person in charge or shall designate a person in charge and shall ensure that a person in charge is present at the retail food establishment during all hours of operation. <sup>Pf</sup>

(B) In a retail food establishment with two or more separately permitted departments that are the legal responsibility of the same permit holder and that are located on the same premises, the permit holder may designate a single person in charge who is present on the premises during all hours of food preparation, production, and service, and who is responsible for each separately permitted retail food establishment on the premises. <sup>Pf</sup>

#### **2-102 Knowledge**

##### ~~2-102.11 Demonstration.~~ **2-102.11 Demonstration.**

Based on the risks inherent to the food operation, during inspections and upon request the person in charge shall demonstrate to the Department knowledge of foodborne disease prevention, application of the Hazard Analysis and Critical Control Point principles, and the requirements of this regulation. The person in charge shall demonstrate this knowledge by:

(A) Complying with this regulation by having no priority violations during the current inspection; <sup>Pf</sup>

(B) Being a certified food protection manager who has shown proficiency of required information through passing a test that is part of an accredited program; <sup>Pf</sup> or

(C) Responding correctly to the inspector's questions as they relate to the specific food operation. The areas of knowledge include:

(1) Describing the relationship between the prevention of foodborne disease and the personal hygiene of a food employee; <sup>Pf</sup>

(2) Explaining the responsibility of the person in charge for preventing the transmission of foodborne disease by a food employee who has a disease or medical condition that may cause foodborne disease; <sup>Pf</sup>

(3) Describing the symptoms associated with the diseases that are transmissible through food; <sup>Pf</sup>

(4) Explaining the significance of the relationship between maintaining the time and temperature of time/temperature control for safety food and the prevention of foodborne illness; <sup>Pf</sup>

(5) Explaining the hazards involved in the consumption of raw or undercooked meat, poultry, eggs, and fish;<sup>Pf</sup>

(6) Stating the required food temperatures and times for safe cooking of time/temperature control for safety food including meat, poultry, eggs, and fish;<sup>Pf</sup>

(7) Stating the required temperatures and times for the safe refrigerated storage, hot holding, cooling, and reheating of time/temperature control for safety food;<sup>Pf</sup>

(8) Describing the relationship between the prevention of foodborne illness and the management and control of the following:

(a) Cross contamination;<sup>Pf</sup>

(b) Hand contact with ready-to-eat foods;<sup>Pf</sup>

(c) Handwashing, <sup>Pf</sup> and

(d) Maintaining the retail food establishment in a clean condition and in good repair;<sup>Pf</sup>

(9) Describing foods identified as major food allergens and the symptoms that a major food allergen could cause in a sensitive individual who has an allergic reaction;<sup>Pf</sup>

~~(9)10~~ Explaining correct procedures for cleaning and sanitizing utensils and food-contact surfaces of equipment;<sup>Pf</sup>

~~(10)1~~ Explaining the details of how the person in charge and food employees comply with the HACCP plan if a plan is required by the law, this regulation, or an agreement between the Department and the retail food establishment.<sup>Pf</sup>

~~2-102.12 Certified Food Protection Manager and Food Handler Certification.~~ **2-102.12 Certified Food Protection Manager and Food Handler Certification.**

(A) At least one employee that has supervisory and management responsibility ~~and, the authority to direct and control food preparation and service, the ability to enforce employee health policies, and a frequent presence at the facility~~ shall be a certified food protection manager who has shown proficiency of required information through passing a test that is part of an accredited program.

(B) At all times during operation, the person in charge shall be a certified food handler or a certified food protection manager who has shown proficiency of required information through passing a test that is part of an accredited program.

~~(B)C~~ This section does not apply to certain types of retail food establishments deemed by the Department to pose minimal risk of causing, or contributing to, foodborne illness based on the nature of the operation and the extent of food preparation.

~~2-102.20 Food Protection Manager Certification.~~ **2-102.20 Food Protection Manager Certification.**

(A) A person in charge who demonstrates knowledge by being a food protection manager that is certified by a food protection manager certification program that is evaluated and listed by a Conference

for Food Protection recognized Protection recognized accrediting agency as conforming to the Conference for Food Protection Standards for Accreditation of Food Protection Manager Certification Programs is deemed to comply with 2-102.11(B).

(B) A retail food establishment that has an employee that is certified by a food protection manager certification program that is evaluated and listed by a Conference for Food Protection recognized accrediting agency as conforming to the Conference for Food Protection Standards for Accreditation of Food Protection Manager Certification Programs is deemed to comply with 2-102.12.

## **2-103 Duties**

### ~~2-103.11 Person in Charge.~~ **2-103.11 Person in Charge.**

The person in charge shall ensure that:

(A) Retail food establishment operations are not conducted in a private residence or in a room used as living or sleeping quarters; <sup>Pf</sup>

(B) Persons unnecessary to the retail food establishment operation are not allowed in the food preparation, food storage, or warewashing areas, except that brief visits and tours may be authorized by the person in charge if steps are taken to ensure that food, clean equipment, utensils, linens, and unwrapped single-service and single-use articles are protected from contamination; <sup>Pf</sup>

(C) Employees and other persons such as delivery and maintenance persons and pesticide applicators entering the food preparation, food storage, and warewashing areas comply with this regulation; <sup>Pf</sup>

(D) Employees are effectively cleaning their hands, by routinely monitoring the employees' handwashing; <sup>Pf</sup>

(E) Employees are visibly observing foods as they are received to determine that they are from approved sources, delivered at the required temperatures, protected from contamination, ~~unadulterated~~ unadulterated, by routinely monitoring the employees' observations and periodically evaluating foods upon their receipt; <sup>Pf</sup>

(F) Employees are verifying that foods delivered to the retail food establishment during non-operating hours are from approved sources and are placed into appropriate storage locations such that they are maintained at the required temperatures, protected from contamination, unadulterated, and accurately presented; <sup>Pf</sup>

(G) Employees are properly cooking time/temperature control for safety foods, being particularly careful in cooking those foods known to cause severe foodborne illness and death, such as eggs and comminuted meats, through daily oversight of the employees' routine monitoring of the cooking temperatures using appropriate temperature measuring devices properly scaled and calibrated; <sup>Pf</sup>

(H) Employees are using proper methods to rapidly cool time/temperature control for safety foods, - through daily oversight of the employees' routine monitoring of food temperatures during cooling; <sup>Pf</sup>

(I) Employees are properly maintaining the temperatures of time/temperature control for safety foods during hot and cold holding through daily oversight of the employees' routine monitoring of food temperatures; <sup>Pf</sup>

(~~I~~) Consumers who order raw; or partially cooked ready-to-eat foods of animal origin are informed by a consumer advisory that the food is not cooked sufficiently to ensure its safety;<sup>pf</sup>

(~~J~~) Employees are properly sanitizing cleaned multiuse equipment and utensils before they are reused; through routine monitoring of solution temperature and exposure time for hot water sanitizing, - and chemical concentration, pH, temperature, and exposure time for chemical sanitizing;<sup>pf</sup>

(~~K~~) Consumers are notified that clean tableware is to be used when they return to self-service areas such as salad bars and buffets;<sup>pf</sup>

(~~L~~) Employees are preventing cross-contamination of ready-to-eat food with bare hands by properly using suitable utensils such as deli tissue, spatulas, tongs, single-use gloves, or dispensing equipment;<sup>pf</sup>

(~~M~~) Employees are properly trained in food safety, as it relates to their assigned duties;<sup>pf</sup>

(~~N~~) Food employees are informed of their responsibility to report to the person in charge information about their health and activities as they relate to diseases that are transmissible through food;<sup>pf</sup>

(~~O~~) ~~That~~The retail food establishment has a written plan for the restriction, exclusion and re-statement of food employees when they are restricted or excluded for conditions as specified in 2-201.12 <sup>pf</sup>; and

(~~P~~) Written procedures and plans, where specified by this regulation and as developed by the retail food establishment, are maintained and implemented as required.<sup>pf</sup>

## **2-2 Employee Health**EMPLOYEE HEALTH

### **2-201 Responsibilities of Permit Holder, Person in Charge, and Food Employees**

#### 2-201.11 Responsibility and Reporting Symptoms and Diagnosis.**2-201.1 Responsibility and Reporting Symptoms and Diagnosis.**

(A) ~~The person in charge~~permit holder shall require food employees to report to the person in charge information about their health and activities as they relate to diseases that are transmissible through food. A food employee shall report the information in a manner that allows the person in charge to reduce the risk of foodborne disease transmission including providing necessary additional information such as the date of onset of symptoms and an illness or of a diagnosis without symptoms if the food employee:

(1) Has any of the following symptoms:

~~(B) If the person in charge knows that a food employee has been diagnosed with an enteric foodborne disease, including but not limited to the following, Norovirus, Hepatitis A virus, Shigella, Enterohemorrhagic or Shiga toxin-producing *Escherichia coli*, *Salmonella*, the person in charge shall report the disease to the Department.~~

~~(C) The food employee shall report to the person in charge if the food employee has any of the following symptoms:~~

~~(4a)~~ Vomiting, <sup>P</sup>

~~(2b)~~ Diarrhea, <sup>P</sup>

~~(3c)~~ Jaundice, <sup>P</sup>

~~(4d)~~ Sore throat with fever, <sup>P</sup> or

~~(e) A lesion containing pus such as a boil or infected wound that is open or draining and is:~~

~~(i) On the hands or wrists, unless an impermeable cover such as a finger cot or stall protects the lesion and a single-use glove is worn over the impermeable cover, <sup>P</sup>~~

~~(ii) On exposed portions of the arms, unless the lesion is protected by an impermeable cover, <sup>P</sup> or~~

~~(iii) On other parts of the body, unless the lesion is covered by a dry, durable, tight-fitting bandage; <sup>P</sup>~~

~~(2) Has an illness diagnosed by a health practitioner due to:~~

~~(a) Norovirus, <sup>P</sup>~~

~~(b) Hepatitis A virus, <sup>P</sup>~~

~~(c) *Shigella* spp., <sup>P</sup>~~

~~(d) Shiga toxin-producing *Escherichia coli*~~

~~(e) Typhoid fever (caused by *Salmonella typhi*) <sup>P</sup> or~~

~~(f) *Salmonella* (nontyphoidal); <sup>P</sup>~~

~~(3) Had Typhoid fever diagnosed by a health practitioner within the past three (3) months without having received antibiotic therapy as determined by a health practitioner; <sup>P</sup>~~

~~(D4) The food employee shall report to the person in charge if the food employee has a lesion containing pus such as a boil or infected wound or burn that is open or draining. Has been exposed to or is the suspected source of a confirmed disease outbreak, because the food employee consumed or prepared food implicated in the outbreak or consumed food at an event prepared by a person who is infected or ill with:~~

~~(a) Norovirus within the past forty-eight (48) hours of the last exposure, <sup>P</sup>~~

~~(b) Shiga toxin-producing *Escherichia coli* *Shigella* spp. within the past three (3) days of the last exposure, <sup>P</sup>~~

~~(c) Typhoid fever within the past fourteen (14) days of the last exposure, <sup>P</sup> or~~

~~(d) Hepatitis A virus within the past thirty (30) days of the last exposure; <sup>P</sup> or~~



(5) Has been exposed by attending or working in a setting where there is a confirmed disease outbreak, or living in the same household as, and having knowledge about, an individual who works or attends a setting where there is a confirmed disease outbreak, or living in the same household as, and having knowledge about, an individual diagnosed with an illness caused by:

(a) Norovirus within the past forty-eight (48) hours of the last exposure.<sup>P</sup>

(b) Shiga toxin-producing *Escherichia coli* *Shigella* spp. within the past three (3) days of the last exposure.<sup>P</sup>

(c) Typhoid fever (caused by *Salmonella* typhi) within the past fourteen (14) days of the last exposure.<sup>P</sup> or

(d) Hepatitis A virus within the past thirty (30) days of the last exposure.<sup>P</sup>

(B) The person in charge shall notify the Department when a food employee is:

(1) Jaundiced.<sup>Pf</sup> or

(2) Diagnosed with an illness due to a pathogen as specified under (A)(2)(a) through (f) of this section.<sup>Pf</sup>

(C) The person in charge shall ensure that a food employee who exhibits or reports a symptom, or who reports a diagnosed illness or a history of exposure as specified under (A)(1) through (5) of this section, is:

(1) Excluded as specified under section 2-201.12 (A) -(C), and (D)(1), (E)(1), (F)(1), (G) or (H)(1) and in compliance with the provisions specified under section 2-201.13(A) through (H);<sup>P</sup> or

(2) Restricted as specified under 2-201.12 (D)(2), (E)(2), (F)(2), (H)(2), or section 2-201.12(I) or (J) and in compliance with the provisions specified under section 2-201.13(D) through (J).<sup>P</sup>

(D) A food employee shall report to the person in charge the information as specified under (A) of this section.<sup>Pf</sup>

(E) A food employee shall:

(1) Comply with an exclusion as specified under section 2-201.12(A) through (C) and 2-201.12(D)(1), (E)(1), (F)(1), (G), or (H)(1) and with the provisions specified under section 2-201.13(A) through (H);<sup>P</sup> or

(2) Comply with a restriction as specified under 2-201.12(D)(2), (E)(2), (F)(2), (G), (H)(2), or section 2-201.12 (H), (I), or (J) and comply with the provisions specified under section 2-201.13(D) through (J).<sup>P</sup>

#### ~~2-201.12 Exclusions and Restrictions.~~ **2-201.1 Exclusions and Restrictions.**

~~(A) The person in charge shall exclude or restrict work duties of a food employee known to be infected with a disease in a communicable form that can be transmitted by food or who is a carrier of organisms that cause such a disease from a retail food establishment in accordance with the following:~~

~~(BA) The person in charge shall exclude or restrict the work duties of a food employee if the food employee has a lesion containing pus such as a boil or infected wound or burn that is open or draining and is: Except when the symptom is from a noninfectious condition, exclude a food employee if the food employee is:~~

~~(1) On the hands or wrists, unless an impermeable cover such as a finger cot protects the lesion— and a single-use glove is worn over the impermeable cover; Symptomatic with vomiting or diarrhea;<sup>P</sup> or~~

~~(2) On exposed portions of the arms, unless the lesion is protected by an impermeable cover; or Symptomatic with vomiting or diarrhea and diagnosed with an infection from Norovirus, *Shigella* spp., *Salmonella* (nontyphoidal), or Shiga toxin-producing *E. coli* <sup>P</sup>~~

~~(3) On other parts of the body, unless the lesion is covered by a dry, durable, tight fitting bandage.~~

~~(B) Exclude a food employee who is:~~

~~(1) Jaundiced and the onset of jaundice occurred within the last seven (7) calendar days, unless the food employee provides to the person in charge written medical documentation from a health practitioner specifying that the jaundice is not caused by Hepatitis A virus or other fecal-orally transmitted infection;<sup>P</sup>~~

~~(2) Diagnosed with an infection from Hepatitis A virus within fourteen (14) calendar days from the onset of any illness symptoms, or within 7 calendar days of the onset of jaundice;<sup>P</sup> or~~

~~(3) Diagnosed with an infection from Hepatitis A virus without developing symptoms.<sup>P</sup>~~

~~(C) Exclude a food employee who is diagnosed with Typhoid fever, or reports having had Typhoid fever within the past three (3) months as specified under 2-201.11(A)(3).<sup>P</sup>~~

~~(D) If a food employee is diagnosed with an infection from Norovirus and is asymptomatic:~~

~~(1) Exclude the food employee who works in a retail food establishment serving a highly susceptible population;<sup>P</sup> or~~

~~(2) Restrict the food employee who works in a retail food establishment not serving a highly susceptible population.<sup>P</sup>~~

~~(E) If a food employee is diagnosed with an infection from *Shigella* spp. and is asymptomatic:~~

~~(1) Exclude the food employee who works in a retail food establishment serving a highly susceptible population;<sup>P</sup> or~~

~~(2) Restrict the food employee who works in a retail food establishment not serving a highly susceptible population.<sup>P</sup>~~

~~(F) If a food employee is diagnosed with an infection from Shiga toxin-producing *E. coli* and is asymptomatic:~~

~~(1) Exclude the food employee who works in a retail food establishment serving a highly susceptible population;<sup>P</sup> or~~

(2) Restrict the food employee who works in a retail food establishment not serving a highly susceptible population.<sup>P</sup>

(G) If a food employee is diagnosed with an infection from *Salmonella* (nontyphoidal) and is asymptomatic, restrict the food employee who works in a retail food establishment serving a highly susceptible population or in a retail food establishment not serving a highly susceptible population.<sup>P</sup>

(H) If a food employee is ill with symptoms of acute onset of sore throat with fever:

(1) Exclude the food employee who works in a retail food establishment serving a highly susceptible population;<sup>P</sup> or

(2) Restrict the food employee who works in a retail food establishment not serving a highly susceptible population.<sup>P</sup>

(I) If a food employee is infected with a skin lesion containing pus such as a boil or infected wound that is open or draining and not properly covered as specified under 2-201.11(A)(1)(e), restrict the food employee.<sup>P</sup>

(J) If a food employee is exposed to a foodborne pathogen as specified under 2-201.11(A)(4)(a) through (d) or 2-201.11(A)(5)(a) through (d), restrict the food employee who works in a retail food establishment serving a highly susceptible population.<sup>P</sup>

## **2-201.13 Removal, Adjustment, or Retention of Exclusions and Restrictions.**

The person in charge shall adhere to the following conditions when removing, adjusting, or retaining the exclusion or restriction of a food employee:

(A) Except when a food employee is diagnosed with Typhoid fever or an infection from hepatitis A virus:

(1) Reinstate a food employee who was excluded as specified under 2-201.12(A)(1) if the food employee:

(a) Is asymptomatic for at least twenty-four (24) hours;<sup>P</sup> or

(b) Provides to the person in charge written medical documentation from a health practitioner that states the symptom is from a noninfectious condition.<sup>P</sup>

(2) If a food employee was diagnosed with an infection from Norovirus and excluded as specified under 2-201.12(A)(2):

(a) Restrict the food employee, who is asymptomatic for at least twenty-four (24) hours and works in a retail food establishment not serving a highly susceptible population, until the conditions for reinstatement as specified under (D)(1) or (2) of this section are met;<sup>P</sup> or

(b) Retain the exclusion for the food employee, who is asymptomatic for at least twenty-four (24) hours and works in a retail food establishment that serves a highly susceptible population, until the conditions for reinstatement as specified under (D)(1) or (2) of this section are met.<sup>P</sup>

(3) If a food employee was diagnosed with an infection from *Shigella* spp. and excluded as specified under 2-201.12(A)(2):

(a) Restrict the food employee, who is asymptomatic for at least twenty-four (24) hours and works in a retail food establishment not serving a highly susceptible population, until the conditions for reinstatement as specified under (E)(1) or (2) of this section are met.<sup>P</sup> or

(b) Retain the exclusion for the food employee, who is asymptomatic for at least twenty-four (24) hours and works in a retail food establishment that serves a highly susceptible population, until the conditions for reinstatement as specified under (E)(1) or (2) or (E)(1) and (3)(a) of this section are met.<sup>P</sup>

(4) If a food employee was diagnosed with an infection from Shiga toxin-producing *Escherichia coli* and excluded as specified under 2-201.12(A)(2):

(a) Restrict the food employee, who is asymptomatic for at least twenty-four (24) hours and works in a retail food establishment not serving a highly susceptible population, until the conditions for reinstatement as specified under (F)(1) or (2) of this section are met.<sup>P</sup> or

(b) Retain the exclusion for the food employee, who is asymptomatic for at least twenty-four (24) hours and works in a retail food establishment that serves a highly susceptible population, until the conditions for reinstatement as specified under (F)(1) or (2) are met.<sup>P</sup>

(5) If a food employee was diagnosed with an infection from *Salmonella* (nontyphoidal) and excluded as specified under 2-201.12(A)(2):

(a) Restrict the food employee, who is asymptomatic for at least thirty (30) days, until conditions for reinstatement as specified under (G)(1) or (2) of this section are met.<sup>P</sup> or

(b) Retain the exclusion for the food employee who is symptomatic, until conditions for reinstatement as specified under Paragraphs (G)(1) or (G)(2) of this section are met.<sup>P</sup>

(B) Reinstate a food employee who was excluded as specified under 2-201.12(B) if the person in charge obtains approval from the Department and one of the following conditions is met:

(1) The food employee has been jaundiced for more than seven (7) calendar days.<sup>P</sup>

(2) The anicteric food employee has been symptomatic with symptoms other than jaundice for more than fourteen (14) calendar days.<sup>P</sup> or

(3) The food employee provides to the person in charge written medical documentation from a health practitioner stating that the food employee is free of a Hepatitis A virus infection.<sup>P</sup>

(C) Reinstate a food employee who was excluded as specified under 2-201.12(C) if the food employee provides to the person in charge written medical documentation from a health practitioner that states the food employee is free from Typhoid fever.<sup>P</sup>

(D) Reinstate a food employee who was excluded as specified under 2-201.12(A)(2) or (D)(1) who was restricted under 2-201.12(D)(2) if:

(1) The excluded or restricted food employee provides to the person in charge written medical documentation from a health practitioner stating that the food employee is free of a Norovirus infection.<sup>P</sup>

(2) The food employee was excluded or restricted after symptoms of vomiting or diarrhea resolved and more than forty-eight (48) hours have passed since the food employee became asymptomatic;<sup>P</sup> or

(3) The food employee was excluded or restricted and did not develop symptoms and more than forty-eight (48) hours have passed since the food employee was diagnosed.<sup>P</sup>

(E) Reinstate a food employee who was excluded as specified under 2-201.12(A)(2) or (E)(1) or who was restricted under 2-201.12(E)(2) if one of the following conditions is met:

(1) The excluded or restricted food employee provides to the person in charge written medical documentation from a health practitioner stating that the food employee is free of a *Shigella* spp. infection based on test results showing two (2) consecutive negative stool specimen cultures that are taken:

(a) Not earlier than forty-eight (48) hours after discontinuance of antibiotics;<sup>P</sup> and

(b) At least twenty-four (24) hours apart;<sup>P</sup>

(2) The food employee was excluded or restricted after symptoms of vomiting or diarrhea resolved, and more than seven (7) calendar days have passed since the food employee became asymptomatic;<sup>P</sup> or

(3) The food employee was excluded or restricted and did not develop symptoms and more than seven (7) calendar days have passed since the food employee was diagnosed.<sup>P</sup>

(F) Reinstate a food employee who was excluded or restricted as specified under 2-201.12(A)(2) or (F)(1) or who was restricted under 2-201.12(F)(2) if one of the following conditions is met:

(1) The excluded or restricted food employee provides to the person in charge written medical documentation from a health practitioner stating that the food employee is free of an infection from Shiga toxin-producing *Escherichia coli* based on test results that show two (2) consecutive negative stool specimen cultures that are taken:

(a) Not earlier than forty-eight (48) hours after discontinuance of antibiotics;<sup>P</sup> and

(b) At least twenty-four (24) hours apart;<sup>P</sup>

(2) The food employee was excluded or restricted after symptoms of vomiting or diarrhea resolved and more than seven (7) calendar days have passed since the food employee became asymptomatic;<sup>P</sup> or

(3) The food employee was excluded or restricted and did not develop symptoms and more than seven (7) days have passed since the food employee was diagnosed.<sup>P</sup>

(G) Reinstate a food employee who was excluded as specified under 2-201.12(A)(2) or who was restricted as specified under 2-201.12(G) if one of the following conditions is met:

(1) The excluded or restricted food employee provides to the person in charge written medical documentation from a health practitioner stating that the food employee is free of a *Salmonella*

(nontyphoidal) infection based on test results showing two (2) consecutive negative stool specimen cultures that are taken;

(a) Not earlier than forty-eight (48) hours after discontinuance of antibiotics,<sup>P</sup> and

(b) At least twenty-four (24) hours apart;<sup>P</sup>

(2) The food employee was restricted after symptoms of vomiting or diarrhea resolved and more than thirty (30) days have passed since the food employee became asymptomatic;<sup>P</sup> or

(3) The food employee was excluded or restricted and did not develop symptoms and more than thirty (30) days have passed since the food employee was diagnosed.<sup>P</sup>

(H) Reinstate a food employee who was excluded or restricted as specified under 2-201.12(H)(1) or (2) if the food employee provides to the person in charge written medical documentation from a health practitioner stating that the food employee meets one of the following conditions:

(1) Has received antibiotic therapy for *Streptococcus pyogenes* infection for more than twenty-four (24) hours;<sup>P</sup>

(2) Has at least one negative throat specimen culture for *Streptococcus pyogenes*;<sup>P</sup> or

(3) Is otherwise determined by a health practitioner to be free of *Streptococcus pyogenes* infection.<sup>P</sup>

(I) Reinstate a food employee who was restricted as specified under 2-201.12(I) if the skin, infected wound, cut, or pustular boil is properly covered with one of the following:

(1) An impermeable cover such as a finger cot or stall and a single-use glove over the impermeable cover if the infected wound or pustular boil is on the hand, finger, or wrist;<sup>P</sup>

(2) An impermeable cover on the arm if the infected wound or pustular boil is on the arm;<sup>P</sup> or

(3) A dry, durable, tight-fitting bandage if the infected wound or pustular boil is on another part of the body.<sup>P</sup>

(J) Reinstate a food employee who was restricted as specified under 2-201.12(J) and was exposed to one of the following pathogens as specified under 2-201.11(A)(4)(a) through (d) or 2-201.11(A)(5)(a) through (d):

(1) Norovirus and one of the following conditions is met:

(a) More than forty-eight (48) hours have passed since the last day the food employee was potentially exposed;<sup>P</sup> or

(b) More than forty-eight (48) hours have passed since the food employee's household contact became asymptomatic.<sup>P</sup>

(2) *Shigella* spp. or Shiga toxin-producing *Escherichia coli* if one of the following conditions is met:

(a) More than three (3) calendar days have passed since the last day the food employee was potentially exposed; <sup>P</sup> or

(b) More than three (3) calendar days have passed since the food employee's household contact became asymptomatic. <sup>P</sup>

(3) Typhoid fever (caused by *Salmonella* Typhi) and one of the following conditions is met:

(a) More than fourteen (14) calendar days have passed since the last day the food employee was potentially exposed; <sup>P</sup> or

(b) More than fourteen (14) calendar days have passed since the food employee's household contact became asymptomatic. <sup>P</sup>

(4) Hepatitis A virus and one of the following conditions is met:

(a) The food employee is immune to Hepatitis A virus infection because of a prior illness from Hepatitis A; <sup>P</sup>

(b) The food employee is immune to Hepatitis A virus infection because of vaccination against Hepatitis A; <sup>P</sup>

(c) The food employee is immune to Hepatitis A virus infection because of IgG administration; <sup>P</sup>

(d) More than thirty (30) calendar days have passed since the last day the food employee was potentially exposed; <sup>P</sup>

(e) More than thirty (30) calendar days have passed since the food employee's household contact became jaundiced; <sup>P</sup> or

(f) The food employee does not use an alternative procedure that allows bare hand contact with ready-to-eat food until at least thirty (30) days after the potential exposure as specified in (I)(4)(d) and (e) of this section, and the food employee receives additional training about:

(i) Hepatitis A symptoms and preventing the transmission of infection. <sup>P</sup>

(ii) Proper handwashing procedures. <sup>P</sup> and

(iii) Protecting ready-to-eat food from contamination introduced by bare hand contact. <sup>P</sup>

~~2-201.120 Departmental Action - Disease Transmission Known or Suspected~~ **2-201.120**  
**Departmental Action - Disease Transmission Known or Suspected.**

(A) When the Department knows or has reasonable cause to suspect transmission of an enteric foodborne disease by a food employee of a facility, the Department may secure a medical history of the suspected food employee or make any other investigation necessary.

(B) The Department may require any or all of the following measures:

(1) The immediate exclusion of the food employee from employment in retail food establishments;

(2) The Department can declare an imminent health hazard requiring the immediate closure of the retail food establishment or any section thereof until no further danger of disease transmission exists;

(3) Restriction of the food employee's services to some other activity in the retail food establishment where there would be no danger of transmitting disease;

(4) Medical and laboratory examination of the food employee;

(5) Laboratory examination of food samples and environmental swabs from the retail food establishment.

## **2-3 Personal Cleanliness PERSONAL CLEANLINESS**

### **2-301 Hands and Arms**

#### ~~2-301.11 Clean Condition.~~ **2-301.11 Clean Condition.**

Food employees shall keep their hands and exposed portions of their arms clean.<sup>P</sup>

#### ~~2-301.12 Cleaning Procedure.~~ **2-301.12 Cleaning Procedure**

(A) Except as specified in (D) of this section, food employees shall clean their hands and exposed portions of their arms, including surrogate prosthetic devices for hands or arms, for at least twenty (20) seconds, using a cleaning compound in a handwashing sink that is equipped as specified under 5-202.12 and 6-301.12.<sup>P</sup>

(B) Food employees shall use the following cleaning procedure in the order stated to clean their hands and exposed portions of their arms, including surrogate prosthetic devices for hands and arms:

(1) Rinse under clean, running warm water;<sup>P</sup>

(2) Apply an amount of cleaning compound recommended by the cleaning compound manufacturer;<sup>P</sup>

(3) Rub together vigorously for at least ten (10) to fifteen (15) seconds while:

(a) Paying particular attention to removing soil from underneath the fingernails during the cleaning procedure,<sup>P</sup> and

(b) Creating friction on the surfaces of the hands and arms or surrogate prosthetic devices for hands and arms, finger-tips, and areas between the fingers;<sup>P</sup>

(4) Thoroughly rinse under clean, running warm water;<sup>P</sup> and

(5) Immediately follow the cleaning procedure with thorough drying using a method as specified under 6-301.12.<sup>P</sup>



(C) To avoid recontaminating their hands or surrogate prosthetic devices, food employees may use disposable paper towels or similar clean barriers when touching surfaces such as manually operated faucet handles on a handwashing sink or the handle of a restroom door.

(D) If approved and capable of removing the types of soils encountered in the food operations involved, an automatic handwashing facility may be used by food employees to clean their hands or surrogate prosthetic devices.

~~2-301.14 When to Wash.~~ **2-301.14 When to Wash.**

Food employees shall clean their hands and exposed portions of their arms as specified under 2-301.12 immediately before engaging in food preparation including working with exposed food, clean equipment and utensils, and unwrapped single-service and single-use articles;<sup>2</sup> and:

(A) After touching bare human body parts other than clean hands and clean, exposed portions of arms;<sup>2</sup>

(B) After using the toilet room;<sup>2</sup>

(C) After caring for or handling service animals, pets, or aquatic animals as specified in 2-403.11(B);<sup>2</sup>

(D) Except as specified in 2-401.11(B) after coughing, sneezing, using a handkerchief or disposable tissue, using tobacco, eating, or drinking;<sup>2</sup>

(E) After handling soiled equipment or utensils;<sup>2</sup>

(F) During food preparation as often as necessary to remove soil and contamination and to prevent cross contamination when changing tasks;<sup>2</sup>

(G) When switching between working with raw food and working with ready-to-eat food;<sup>2</sup>

(H) Before donning gloves to initiate a task that involves working with food;<sup>2</sup> and

(I) After engaging in other activities that contaminate the hands.<sup>2</sup>

~~2-301.15 Where to Wash.~~ **2-301.15 Where to Wash.**

Food employees shall clean their hands in a handwashing sink or approved automatic handwashing facility and may not clean their hands in a sink used for food preparation or warewashing, or in a service sink or a curbed cleaning facility used for the disposal of mop water and similar liquid waste.<sup>2f</sup>

~~2-301.16 Hand Antiseptics.~~ **2-301.16 Hand Antiseptics.**

(A) A hand antiseptic used as a topical application, a hand antiseptic solution used as a hand dip, or a hand antiseptic soap shall:

(1) Comply with one of the following:

(a) Be an approved drug that is listed in the FDA publication *Approved Drug Products with Therapeutic Equivalence Evaluations* approved drug based on safety and effectiveness;<sup>2f</sup> or

(b) Have active antimicrobial ingredients that are listed in the FDA monograph for *OTC Health-Care Antiseptic Drug Products*, antiseptic handwash, <sup>PF</sup>and

(2) Consist only of components which the intended use of each complies with one of the following:

(a) A threshold of regulation exemption under 21 CFR 170.39, *Threshold of Regulation For Substances Used in Food-Contact Articles*

(b) 21 CFR 178, *Indirect Food Additives: Adjuvants, Production Aids, and Sanitizers* regulated for use as a food additive with conditions of safe use; <sup>PF</sup>or

(c) A determination of generally recognized as safe (GRAS). Partial listings of substances with food uses that are GRAS may be found in 21 CFR 182, *Substances Generally Recognized as Safe*, 21 CFR 184, *Direct Food Substances Affirmed as Generally Recognized as Safe*, 21 CFR 186, *Indirect Food Substances Affirmed as Generally Recognized as Safe for Use in Contact with Food*, and FDA's *Inventory of GRAS Notices*;

(d) A prior sanction listed under 21 CFR 181, *Prior Sanctioned Food Ingredients*,

(e) a *Food Contact Notification* is effective, <sup>PF</sup>and

(3) Be applied only to hands that are cleaned as specified under 2-301.12. <sup>PF</sup>

(B) If a hand antiseptic does not meet the criteria specified under (A)(2) of this section, use shall be:

(1) Followed by thorough hand rinsing in clean water before hand contact with food or by the use of gloves; <sup>PF</sup>or

(2) Limited to situations that involve no direct contact with food by the bare hands. <sup>PF</sup>

(C) A hand antiseptic solution used as a hand dip shall be maintained clean and at a strength equivalent to at least 100 MG/L chlorine. <sup>PF</sup>

## **2-302 Fingernails**

### ~~2-302.11 Maintenance.~~ **2-302.11 Maintenance.**

(A) Food employees shall keep their fingernails trimmed, filed, and maintained so the edges and surfaces are cleanable and not rough. Nail length shall not extend beyond the fingertips. <sup>PF</sup>

(B) Unless wearing intact gloves in good repair, a food employee may not wear fingernail polish or artificial fingernails when working with exposed food. <sup>PF</sup>

## **2-303 Jewelry**

### ~~2-303.11 Prohibition.~~ **2-303.11 Prohibition.**

(A) Except for a plain ring such as a wedding band, while preparing food, food employees shall not wear jewelry on their arms and hands, including medical information jewelry, on their arms or hands.

(B) If jewelry cannot be removed for medical or religious reasons, it must be covered with a clean intact single-use glove when working with food.

## **2-304**Outer Clothing

### ~~2-304.11 Clean Condition.~~ **2-304.11 Clean Condition.**

Food employees shall wear clean outer clothing to prevent contamination of food, equipment, utensils, linens, and single-service and single-use articles.

## **2-4**Hygienic PracticesHYGIENIC PRACTICES

### **2-401**Food Contamination Prevention

#### ~~2-401.11 Eating, Drinking, or Using Tobacco.~~ **2-401.11 Eating, Drinking, or Using Tobacco.**

(A) Except as specified in (B) of this section, an employee shall eat, drink, or use any form of tobacco only in designated areas where the contamination of exposed food, clean equipment, utensils, and linens, unwrapped single-service and single-use articles, or other items needing protection cannot result.

(B) A food employee may drink from a closed beverage container if the container is handled to prevent contamination of:

- (1) The food employee's hands;
- (2) The container; and
- (3) Exposed food, clean equipment, utensils, and linens; and unwrapped single-service and single-use articles.

#### ~~2-401.12 Discharges from the Eyes, Nose, and Mouth.~~ **2-401.12 Discharge from the Eyes, Nose, and Mouth.**

Food employees experiencing persistent sneezing, coughing, or a runny nose that causes discharges from the eyes, nose, or mouth shall not work with exposed food, clean equipment, utensils, and linens, or unwrapped single-service or single-use articles.

#### **2-401.13 Use of Bandages, Finger Cots, or Finger Stalls.**

If used, an impermeable cover such as a bandage, finger cot, or finger stall located on the wrist, hand, or finger of a food employee working with exposed food shall be covered with a single-use glove.

### **2-402**Hair Restraints

#### ~~2-402.11 Effectiveness.~~ **2-402.1 Effectiveness.**

(A) Except as provided in (B) of this section, food employees shall wear hair restraints such as hats, hair covering and nets, beard restraints for beards that are not close trimmed, and clothing that covers

body hair that are designed and worn to effectively keep their hair from contacting exposed food, clean equipment, utensils, ~~and~~ linens, and unwrapped single-service or single-use articles.

(B) This section does not apply to food employees such as counter staff who only serve beverages and wrapped or packaged food, hostesses, and wait staff, if they present a minimal risk of contaminating exposed food, clean equipment, utensils, ~~and~~ linens and unwrapped single-service or single-use articles.

## **2-403 Animals**

### ~~2-403.11 Handling Prohibition.~~ **2-403.11 Handling Prohibition.**

(A) Except as specified in (B) of this section, food employees may not care for or handle animals that may be present such as patrol dogs, service animals, or pets that are allowed as specified in 6-501.115 (B)(2) through (5) or section 9-3 “Outdoor Pet Dining”.<sup>Pf</sup>

(B) Food employees with service animals may handle or care for their service animals, and food employees may handle or care for fish in aquariums or molluscan shellfish or crustacean in display tanks, if they wash their hands as specified in 2-301.12 and 2-301.14(C).

## ~~2-5 Responding to Contamination Events~~ **RESPONDING TO CONTAMINATION EVENTS**

### **2-501 Procedures for Responding**

#### ~~2-501.11 Clean-up of Vomiting and Diarrheal Events.~~ **2-501.11 Clean-up of Vomiting and Diarrheal Events.**

A retail food establishment shall have written procedures for employees to follow when responding to vomiting or diarrheal events that involve the discharge of vomitus or fecal matter onto surfaces in the retail food establishment. The procedures shall address the specific actions employees must take to minimize the spread of contamination and the exposure of employees, consumers, food, and surfaces to vomitus or fecal matter.<sup>Pf</sup>

## **Chapter Food**

### **3-1 CHARACTERISTICS**

#### **3-101 Condition**

##### ~~3-101.11 Safe, and Unadulterated, and Honestly Presented.~~ **3-101.11 Safe, Unadulterated, and Honestly Presented.**

Food shall be safe, unadulterated, and, as specified under 3-601.12, honestly presented.<sup>P</sup>

### **3-2 SOURCES, SPECIFICATIONS, AND ORIGINAL CONTAINERS AND RECORDS**

#### **3-201 Sources**

##### ~~3-201.11 Compliance with Food Law.~~ **3-201.11 Compliance with Food Law.**

(A) Food shall be obtained from sources that comply with law.<sup>P</sup>

(B) Food prepared in a private home shall not be used or offered for human consumption in a retail food establishment. <sup>P</sup>

(C) Packaged food shall be labeled as specified in law, including 21 CFR 101, *Food Labeling* CFR 317, *Labeling, Marking Devices, and Containers*, CFR 381 Subpart N, *Labeling and Containers*, and as specified under 3-202.17 and 3-202.18. <sup>Pf</sup>

(D) Fish, other than those specified in 3-402.11(B), that are intended for consumption in raw or undercooked form and allowed as specified in 3-401.11(D), may be offered for sale or service if they are obtained from a supplier that freezes the fish as specified under 3-402.11 or if they are frozen on the premises as specified under 3-402.11 and records are retained as specified under 3-402.12.

(E) Whole-muscle, intact beef steaks that are intended for consumption in an undercooked form without a consumer advisory as specified in 3-401.11(C) shall be:

(1) Obtained from a food processing plant that, upon request by the purchaser, packages the steaks and labels them to indicate that the steaks meet the definition of whole-muscle, intact beef, <sup>Pf</sup>or

(2) Deemed acceptable by the Department based on other evidence, ~~such as written buyer specifications or invoices, that indicates that the steaks meet the definition of whole-muscle, intact beef,~~ <sup>Pf</sup>and

(3) If individually cut in a retail food establishment:

(a) Cut from whole-muscle intact beef that is labeled by a food processing plant as specified in (E)(1) of this section or identified as specified in (E)(2) of this section, <sup>P</sup>

(b) Prepared so they remain intact, <sup>Pf</sup>and

(c) If packaged for undercooking in a retail food establishment, labeled as specified in (E)(1) of this section or identified as specified in (E)(2) of this section. <sup>Pf</sup>

(F) Meat and poultry that is not a ready-to-eat food and is in a packaged form when it is offered for sale or otherwise offered for consumption shall be labeled to include safe handling instructions as specified in law, including 9 CFR 317.2(l) and 9 CFR 381.125(b).

(G) Eggs that have not been specifically treated to destroy all viable *Salmonella* shall be labeled to include safe handling instructions as specified in law, including 21 CFR 101.17(h).

~~3-201.12 Food in a Hermetically Sealed Container.~~ **3-201.12 Food in a Hermetically Sealed Container.**

Food in a hermetically sealed container shall be obtained from a food processing plant that is regulated by the food regulatory agency that has jurisdiction over the plant. <sup>P</sup>

~~3-201.13 Fluid Milk, Dry Milk, and Milk Products.~~ **3-201.13 Fluid Milk, Dry Milk, and Milk Products.**

Fluid milk, dry milk, and milk products shall be obtained from sources that comply with Grade A standards as specified in law. <sup>P</sup>

~~3-201.14 Fish.~~ **3-201.14 Fish.**

(A) Fish that are received for sale or service shall be:

- (1) Commercially and legally caught or harvested,<sup>P</sup> or
- (2) Approved for sale or service.<sup>P</sup>

(B) Molluscan shellfish that are recreationally caught may not be received for sale or service.<sup>P</sup>

~~3-201.15 Molluscan Shellfish.~~ **3-201.15 Molluscan Shellfish.**

(A) Molluscan shellfish shall be obtained from sources according to law and the requirements specified in the U.S. Department of Health and Human Services, Public Health Service, Food and Drug Administration, *National Shellfish Sanitation Program Guide for the Control of Molluscan Shellfish*

(B) Molluscan shellfish received in interstate commerce shall be from sources that are listed in the *Interstate Certified Shellfish Shippers List*

~~3-201.16 Wild Mushrooms.~~ **3-201.16 Wild Mushrooms.**

(A) Except as specified in (B) of this section, mushroom species picked in the wild shall be obtained from sources where each mushroom is individually inspected and found to be safe by an approved mushroom identification expert as specified in *9-4, Wild Mushroom Foraging*

(B) This section does not apply to:

(1) Cultivated wild mushroom species that are grown, harvested, and processed in an operation that is regulated by the food regulatory agency that has jurisdiction over the operation; or

(2) Wild mushroom species, if they are in packaged form and are the product of a food processing plant that is regulated by the food regulatory agency that has jurisdiction over the plant.

~~3-201.17 Game Animals.~~ **3-201.17 Game Animals.**

(A) If game animals are received for sale or service they shall be:

(1) Commercially raised for food<sup>P</sup> and:

(a) Raised, slaughtered, and processed under a voluntary inspection program that is conducted by the agency that has animal health jurisdiction,<sup>P</sup> or

(b) Under a routine inspection program conducted by a regulatory agency other than the agency that has animal health jurisdiction,<sup>P</sup> and

(c) Raised, slaughtered, and processed according to:

(i) Laws governing meat and poultry as determined by the agency that has animal health jurisdiction and the agency that conducts the inspection program,<sup>P</sup> and

(ii) Requirements which are developed by the agency that has animal health jurisdiction and the agency that conducts the inspection program with consideration of factors such as the need for antemortem and postmortem examination by an approved veterinarian or veterinarian's designee;<sup>2</sup>

(2) Under a voluntary inspection program administered by the USDA for game animals such as exotic animals (reindeer, elk, deer, antelope, water buffalo, or bison) that are "inspected and approved" in accordance with 9 CFR 352, *Exotic Animals*, voluntary inspection or rabbits that are "inspected and certified" in accordance with 9 CFR 354, *Voluntary Inspection Of Rabbits And Edible Products Thereof*

(3) As allowed by law for wild game animals that are live-caught:

(a) Under a routine inspection program conducted by a regulatory agency such as the agency that has animal health jurisdiction,<sup>2</sup> and

(b) Slaughtered and processed according to:

(i) Laws governing meat and poultry as determined by the agency that has animal health jurisdiction and the agency that conducts the inspection program,<sup>2</sup> and

(ii) Requirements which are developed by the agency that has animal health jurisdiction and the agency that conducts the inspection program with consideration of factors such as the need for antemortem and postmortem examination by an approved veterinarian or veterinarian's designee;<sup>2</sup> or

(4) As allowed by law, for field-dressed wild game animals under a routine inspection program that ensures the animals:

(a) Receive a postmortem examination by an approved veterinarian or veterinarian's designee,<sup>2</sup> or

(b) Are field-dressed and transported according to requirements specified by the agency that has animal health jurisdiction and the agency that conducts the inspection program,<sup>2</sup> and

(c) Are processed according to laws governing meat and poultry as determined by the agency that has animal health jurisdiction and the agency that conducts the inspection program.<sup>2</sup>

(B) A game animal may not be received for sale or service if it is a species of wildlife that is listed in 50 CFR 17, *Endangered Aand Threatened Wildlife Aand Plants*

### **3-202 Specifications for Receiving**

#### ~~3-202.11 Temperature.~~ **3-202.1 Temperature.**

(A) Except as specified in (B) of this section, refrigerated, time/temperature control for safety food shall be at a temperature of 41 degree F (5 degree C) or below when received.<sup>2</sup>

(B) If a temperature other than 41 degree F (5 degree C) for a time/temperature control for safety food is specified in law governing its distribution, such as laws governing milk and molluscan shellfish, the food may be received at the specified temperature.

(C) Raw eggs shall be received in refrigerated equipment that maintains an ambient air temperature of 45 degrees F (7 degrees C) or less.<sup>2</sup>

(D) Time/temperature control for safety food that is cooked to a temperature and for a time specified under 3-401.11 through 3-401.13 and received hot shall be at a temperature of 135 degrees F (57 degrees C) or above. <sup>2</sup>

(E) A food that is labeled frozen and shipped frozen by a food processing plant shall be received frozen. <sup>2f</sup>

(F) Upon receipt, time/temperature control for safety food shall be free of evidence of previous temperature abuse. <sup>2f</sup>

~~3-202.12 Additives.~~ **3-202.12 Additives.**

Food may not contain unapproved food additives or additives that exceed amounts specified in 21 CFR 170-180 relating to *Food Additives, Generally Recognized As Safe* or *Food Additives, Generally Recognized As Safe* substances that exceed amounts specified in 21 CFR ~~181-186~~ 181 through 186, substances that exceed amounts specified in 9 CFR Subpart C Section 424.21(b) *Food Ingredients And Sources Of Radiation, Or Pesticide Residues* exceed provisions specified in 40 CFR 180, *Tolerances For Pesticides Chemicals In Food, And Exceptions*

~~3-202.13 Eggs.~~ **3-202.13 Eggs.**

Eggs shall be received clean and sound and shall not exceed the restricted egg tolerances for U.S. Consumer Grade B as specified in *United States Standards, Grades, and Weight Classes for Shell Eggs* AMS 56.200 et seq., administered by the Agricultural Marketing Service of USDA. <sup>2</sup>

~~3-202.14 Egg and Milk Products, Pasteurized.~~ **3-202.14 Egg and Milk Products, Pasteurized.**

(A) Egg products shall be obtained pasteurized. <sup>2</sup>

(B) Fluid and dry milk and milk products used and served shall, except as specified in (E) of this section:

(1) Be obtained pasteurized; <sup>2</sup> and

(2) Comply with Grade A standards as specified in law. <sup>2</sup>

(C) Frozen milk products, such as ice cream, shall be obtained pasteurized as specified in 21 CFR 135, *Frozen deserts*

(D) Cheese shall be obtained pasteurized unless alternative procedures to pasteurization are specified in the CFR, such as 21 CFR 133 *Cheeses and Related Cheese Products, for curing certain cheese varieties* curing certain cheese varieties. <sup>2</sup>

(E) Packaged raw milk may be obtained for re-sale, provided it meets the requirements of R.61-34, *Raw Milk for Human Consumption*

~~3-202.15 Package Integrity.~~ **3-202.15 Package Integrity.**

Food packages shall be in good condition and protect the integrity of the contents so that the food is not exposed to adulteration or potential contaminants. <sup>2f</sup>



~~3-202.16 Ice.~~ **3-202.16 Ice.**

Ice for use as a food or cooling medium shall be made from drinking water.<sup>pf</sup>

~~3-202.17 Shucked Shellfish, Packing and Identification.~~ **3-202.17 Shucked Shellfish, Packing and Identification.**

(A) Raw shucked shellfish shall be obtained in nonreturnable packages which bear a legible label that identifies the <sup>pf</sup>:

(1) Name, address, and certification number of the shucker, packer, or repacker of the molluscan shellfish; and

(2) The "sell by" or "best if used by" date for packages with a capacity of less than 1.89 L (one-half gallon) or the date shucked for packages with a capacity of 1.89 L (one-half gallon) or more.<sup>pf</sup>

(B) A package of raw shucked shellfish that does not bear a label or which bears a label which does not contain all the information as specified under (A) of this section shall be subject to a hold order, as allowed by law, or seizure and destruction in accordance with 21 CFR Subpart D, *Specific Administrative Decisions Regarding Interstate Shipments* 240.60(d), *Molluscan Shellfish*

~~3-202.18 Shellstock Identification.~~ **3-202.18 Shellstock Identification.**

(A) Shellstock shall be obtained in containers bearing legible source identification tags or labels that are affixed by the harvester or dealer that depurates, ships, or reships the shellstock, as specified in the *National Shellfish Sanitation Program Guide for the Control of Molluscan Shellfish*

(1) Except as specified under (C) of this section, on the harvester's tag or label, the following information in the following order:

(a) The harvester's identification number that is assigned by the shellfish control authority;<sup>pf</sup>

(b) The date of harvesting,<sup>pf</sup>

(c) The most precise identification of the harvest location or aquaculture site that is practicable based on the system of harvest area designations that is in use by the shellfish control authority and including the abbreviation of the name of the state or country in which the shellfish are harvested,<sup>pf</sup>

(d) The type and quantity of shellfish,<sup>pf</sup> and

(e) The following statement in bold, capitalized type: "This tag is required to be attached until container is empty or retagged and thereafter kept on file for ninety (90) days";<sup>pf</sup> and

(2) Except as specified in (D) of this section, on each dealer's tag or label, the following information in the following order: <sup>pf</sup>

(a) The dealer's name, ~~and~~ address, and the certification number assigned by the shellfish control authority,<sup>pf</sup>

(b) The original shipper's certification number including the abbreviation of the name of the state or country in which the shellfish are harvested,<sup>pf</sup>

(c) The same information as specified for a harvester's tag under (A)(1)(b) through (d) of this section,<sup>pf</sup> and

(d) The following statement in bold, capitalized type: "This tag is required to be attached until container is empty and thereafter kept on file for ninety (90) days."<sup>pf</sup>

(B) A container of shellstock that does not bear a tag or label or that bears a tag or label that does not contain all the information as specified under (A) of this section shall be subject to a hold order, as allowed by law, or seizure and destruction in accordance with 21 CFR Subpart D, *Specific Administrative Decisions Regarding Interstate Shipments* 240.60(d), *Molluscan Shellfish*

(C) If a place is provided on the harvester's tag or label for a dealer's name, address, and certification number, the dealer's information shall be listed first.

(D) If the harvester's tag or label is designed to accommodate each dealer's identification as specified under (A)(2)(a) and (b) of this section, individual dealer tags or labels need not be provided.

(E) The statement "Keep Refrigerated" or an equivalent statement must be included on the tag.

~~3-202.19 Shellstock Condition.~~ **3-202.19 Shellstock Condition.**

When received by a retail food establishment, shellstock shall be reasonably free of mud, dead shellfish, and shellfish with broken shells. Dead shellfish or shellstock with badly broken shells shall be discarded.

~~3-202.110 Juice Treated.~~ **3-202.110 Juice Treated.**

Pre-packaged juice shall:

(A) Be obtained from a processor with a HACCP system as specified in 21 CFR Part 120, *Hazard Analysis and Critical Control (HACCP) Systems*<sup>pf</sup>

(B) Be obtained pasteurized or otherwise treated to attain a 5-log reduction of the most resistant microorganism of public health significance as specified in 21 CFR Part 120.24, *Process Controls*.

~~3-203 Original Containers and Records~~

~~3-203.11 Molluscan Shellfish, Original Container.~~ **3-203.11 Molluscan Shellfish, Original Container.**

(A) Except as specified in (B) through (D) of this section, molluscan shellfish may not be removed from the container in which they are received other than immediately before sale or preparation for service.

(B) For display purposes, shellstock may be removed from the container in which they are received, displayed on drained ice, or held in a display container, and a quantity specified by a consumer may be removed from the display or display container and provided to the consumer if:

(1) The source of the shellstock on display is identified as specified under 3-202.18 and recorded as specified under 3-203.12; and

(2) The shellstock are protected from contamination.

(C) Shucked shellfish may be removed from the container in which they were received and held in a display container from which individual servings are dispensed upon a consumer's request if:

(1) The labeling information for the shellfish on display as specified under 3-202.17 is retained and correlated to the date when, or dates during which, the shellfish are sold or served; and

(2) The shellfish are protected from contamination.

(D) Shucked shellfish may be removed from the container in which they were received and repacked in consumer self-service containers where allowed by law if:

(1) The labeling information for the shellfish is on each consumer self-service container as specified under 3-202.17 and 3-602.11;

(2) The labeling information as specified under 3-202.17 is retained and correlated with the date when, or dates during which, the shellfish are sold or served;

(3) The labeling information and dates specified under (D)(2) of this section are maintained for ninety (90) days; and

(4) The shellfish are protected from contamination.

~~3-203.12 Shellstock, Maintaining Identification.~~ **3-203.19 Shellstock, Maintaining Identification.**

(A) Except as specified under (C)(2) of this section, shellstock tags or labels shall remain attached to the container in which the shellstock are received until the container is empty.<sup>Pf</sup>

(B) The date when the last shellstock from the container is sold or served shall be recorded on the tag or label.<sup>Pf</sup>

(C) The identity of the source of shellstock that are sold or served shall be maintained by retaining shellstock tags or labels for ninety (90) calendar days from the date that is recorded on the tag or label, as specified under (B) of this section, by:<sup>Pf</sup>

(1) Using an approved record keeping system that keeps the tags or labels in chronological order correlated to the date that is recorded on the tag or label, as specified under (B) of this section;<sup>Pf</sup> and

(2) If shellstock are removed from its tagged or labeled container:

(a) Preserving source identification by using a record keeping system as specified under (C)(1) of this section,<sup>Pf</sup> and

(b) Ensuring that shellstock from one tagged or labeled container are not commingled with shellstock from another container with different certification numbers; different harvest dates; or different growing areas as identified on the tag or label before being ordered by the consumer.<sup>Pf</sup>

### **3-3 PROTECTION FROM CONTAMINATION AFTER RECEIVING**

#### **3-301 Preventing Contamination by Employees**

##### ~~3-301.11 Preventing Contamination from Hands.~~ **3-301.11 Preventing Contamination from Hands.**

(A) Food employees shall wash their hands as specified under 2-301.12.

(B) Except when washing fruits and vegetables as specified under 3-302.15 or as specified in (D) of this section, food employees may not contact exposed, ready-to-eat food with their bare hands and shall use suitable utensils such as deli tissue, spatulas, tongs, single-use gloves, or dispensing equipment.<sup>P</sup>

(C) Food employees shall minimize bare hand and arm contact with exposed food that is not in a ready-to-eat form.<sup>Pf</sup>

(D) Paragraph (B) of this section does not apply to a food employee who contacts exposed, ready-to-eat food with bare hands at the time the ready-to-eat food is being added as an ingredient to a food that:

(1) Contains a raw animal food and is to be cooked in the retail food establishment to heat all parts of the food to the minimum temperatures specified in 3-401.11(A) and (B) or 3-401.12<sub>2</sub>; or

(2) Does not contain a raw animal food but is to be cooked in the retail food establishment to heat all parts of the food to a temperature of at least 145 degree F (63 degree C).

##### ~~3-301.12 Preventing Contamination When Tasting.~~ **3-301.12 Preventing Contamination When Tasting.**

A food employee may not use a utensil more than once to taste food that is to be sold or served.<sup>P</sup>

#### **3-302 Preventing Food and Ingredient Contamination**

##### ~~3-302.11 Packaged and Unpackaged Food - Separation, Packaging, and Segregation.~~ **3-302.11 Packaged and Unpackaged Food - Separation, Packaging, and Segregation.**

(A) Food shall be protected from cross contamination by:

(1) Except as specified in (1)(~~ed~~) below, separating raw animal foods during storage, preparation, holding, and display from:

(a) Raw ready-to-eat food including other raw animal food such as fish for sushi or molluscan shellfish, or other raw ready-to-eat food such as fruits and vegetables,<sup>P</sup> and

(b) Cooked ready-to-eat food; <sup>P</sup> and

(c) Fruits and vegetables before they are washed; <sup>P</sup> and

(~~ed~~) Frozen, commercially processed and packaged raw animal food may be stored or displayed with or above frozen, commercially processed and packaged, ready-to-eat food.

(2) Except when combined as ingredients, separating types of raw animal foods from each other such as beef, fish, lamb, pork, and poultry during storage, preparation, holding, and display by:

- (a) Using separate equipment for each type, <sup>2</sup>or
  - (b) Arranging each type of food in equipment so that cross contamination of one type with another is prevented, <sup>2</sup>and
  - (c) Preparing each type of food at different times or in separate areas;<sup>2</sup>
- (3) Cleaning equipment and utensils as specified under 4-602.11(A) and sanitizing as specified under 4-703.11;
  - (4) Except as specified under 3-501.15(B)(2) and in (B) of this section, storing the food in packages, covered containers, or wrappings;
  - (5) Cleaning hermetically sealed containers of food of visible soil before opening;
  - (6) Protecting food containers that are received packaged together in a case or overwrap from cuts when the case or overwrap is opened;
  - (7) Storing damaged, spoiled, or recalled food being held in the retail food establishment as specified under 6-404.11; and
  - (8) Separating fruits and vegetables before they are washed, as specified under 3-302.15, from ready-to-eat food.

(B) Subparagraph (A)(4) of this section does not apply to:

- (1) Whole, uncut, raw fruits and vegetables and nuts in the shell, that require peeling or hulling before consumption;
- (2) Primal cuts, quarters, or sides of raw meat or slab bacon that are hung on clean, sanitized hooks or placed on clean, sanitized racks;
- (3) Whole, uncut, processed meats such as country hams, and smoked or cured sausages that are placed on clean, sanitized racks;
- (4) Food being cooled as specified under 3-501.15(B)(2); or
- (5) Shellstock.

~~3-302.12 Food Storage Containers, Identified with Common Name of Food.~~ **3-302.12 Food Storage Containers, Identified with Common Name of Food.**

Except for containers holding food that can be readily and unmistakably recognized, such as dry pasta, working containers holding food or food ingredients that are removed from their original packages for use in the retail food establishment, such as cooking oils, flour, herbs, potato flakes, salt, spices, and sugar, shall be identified with the common name of the food.

~~3-302.13 Pasteurized Eggs, Substitute for Raw Eggs for Certain Recipes.~~ **3-302.13 Pasteurized Eggs, Substitute for Raw Eggs for Certain Recipes.**

Pasteurized eggs or egg products shall be substituted for raw eggs in the preparation of foods such as Caesar salad, hollandaise or Béarnaise sauce, mayonnaise, meringue, eggnog, ice cream, and egg-fortified beverages that are not: <sup>P</sup>

(A) Cooked as specified under 3-401.11(A)(1) or (2); <sup>P</sup> or

(B) Included in 3-401.11(D).<sup>P</sup>

~~3-302.14 Protection from Unapproved Additives.~~ **3-302.14 Protection from Unapproved Additives.**

(A) Food shall be protected from contamination that may result from the addition of, as specified in 3-202.12:

(1) Unsafe or unapproved food or color additives; <sup>P</sup> and

(2) Unsafe or unapproved levels of approved food and color additives. <sup>P</sup>

(B) A food employee may not:

(1) Apply sulfiting agents to fresh fruits and vegetables intended for raw consumption or to a food considered to be a good source of vitamin B<sub>1</sub>; <sup>P</sup> or

(2) Except for grapes, serve or sell food specified under (B)(1) of this section that is treated with sulfiting agents before receipt by the retail food establishment. <sup>P</sup>

~~3-302.15 Washing Fruits and Vegetables.~~ **3-302.15 Washing Fruits and Vegetables.**

(A) Except as specified in (B) of this section and except for whole, raw fruits and vegetables that are intended for washing by the consumer before consumption, raw fruits and vegetables shall be thoroughly washed in water to remove soil and other contaminants before being cut, combined with other ingredients, cooked, served, or offered for human consumption in ready-to-eat form.

(B) Fruits and vegetables may be washed by using chemicals as specified under 7-204.12.

(C) Devices used for on-site generation of chemicals meeting the requirements specified in 21 CFR 173.315, *Chemicals used in the washing or to assist in the peeling of fruits and vegetables*, ~~Used in the Washing or to Assist in the Peeling of Fruits and Vegetables~~ *Used in the Washing of raw, whole fruits and vegetables* shall be used in accordance with the manufacturer's instructions. <sup>Pf</sup>

**3-303 Preventing Contamination from Ice Used as a Coolant**

~~3-303.11 Ice Used as Exterior Coolant, Prohibited as Ingredient.~~ **3-303.11 Ice Used as Exterior Coolant, Prohibited as Ingredient.**

After use as a medium for cooling the exterior surfaces of food such as melons or fish, packaged foods such as canned beverages, or cooling coils and tubes of equipment, ice may not be used as food. <sup>P</sup>

~~3-303.12 Storage or Display of Food in Contact with Water or Ice.~~ **3-303.12 Storage or Display of Food in Contact with Water or Ice.**

(A) Packaged food may not be stored in direct contact with ice or water if the food is subject to the entry of water because of the nature of its packaging, wrapping, or container or its positioning in the ice or water.

(B) Except as specified in (C) and (D) of this section, unpackaged food may not be stored in direct contact with undrained ice.

(C) Whole, raw fruits or vegetables; cut, raw vegetables such as celery or carrot sticks or cut potatoes; and tofu may be immersed in ice or water.

(D) Raw poultry and raw fish that are received immersed in ice in shipping containers may remain in that condition while in storage awaiting preparation, display, service, or sale.

### **3-304 Preventing Contamination from Equipment, Utensils, and Linens**

#### **3-304.11 Food Contact with Equipment and Utensils. ~~3-304.11 Food Contact with Equipment and Utensils.~~**

Food shall only contact surfaces of:

(A) Equipment and utensils that are cleaned as specified under Section 4-6 of this regulation and sanitized as specified under Section 4-7 of this regulation;<sup>2</sup>

(B) Single-service and single-use articles;<sup>2</sup> or

(C) Linens, such as cloth napkins, as specified in 3-304.13 that are laundered as specified under Section 4-8 of this regulation. <sup>2</sup>

#### **3-304.12 In-Use, Between-Use Storage. ~~3-304.12 In-Use, Between-Use Storage.~~**

During pauses in food preparation or dispensing, food preparation and dispensing utensils shall be stored:

(A) Except as specified under (B) of this section, in the food with their handles above the top of the food and the container;

(B) In food that is not a time/temperature control for safety food with their handles above the top of the food within containers or equipment that can be closed, such as bins of sugar, flour, or cinnamon;

(C) On a clean portion of the food preparation table or cooking equipment only if the in-use utensil and the food-contact surface of the food preparation table or cooking equipment are cleaned and sanitized at a frequency specified under 4-602.11 and 4-702.11;

(D) In running water of sufficient velocity to flush particulates to the drain, if used with moist food such as ice cream or mashed potatoes;

(E) In a clean, protected location if the utensils, such as ice scoops, are used only with a food that is not time/temperature control for safety food; or

(F) In a container of water if the water is maintained at a temperature of at least 135 degrees F (57 degrees C) and the container is cleaned at a frequency specified under 4-602.11(D)(57).

~~3-304.13 Linens and Napkins, Use Limitation.~~ **3-304.13 Linens and Napkins, Use Limitation.**

Linens, such as cloth napkins, shall not be used in contact with food unless they are used to line a container for the service of foods and the linens and napkins are replaced each time the container is refilled for a new consumer.

~~3-304.14 Wiping Cloths, Use Limitation.~~ **3-304.14 Wiping Cloths, Use Limitation.**

(A) Cloths in-use for wiping food spills from tableware and carry-out containers that occur as food is being served shall be:

- (1) Maintained dry; and
- (2) Used for no other purpose.

(B) Cloths in-use for wiping counters and other equipment surfaces shall be:

- (1) Held between uses in a chemical sanitizer solution at a concentration specified under 4-501.114<sub>2</sub> and
- (2) Laundered daily as specified under 4-802.11(D).

(C) Cloths in-use for wiping surfaces in contact with raw animal foods shall be kept separate from cloths used for other purposes.

(D) Dry wiping cloths and the chemical sanitizing solutions specified in (B)(1) of this section in which wet wiping cloths are held between uses shall be free of food debris and visible soil.

(E) Containers of chemical sanitizing solutions specified in (B)(1) of this section in which wet wiping cloths are held between uses shall be stored off the floor and used in a manner that prevents contamination of food, equipment, utensils, linens, single-service, or single-use articles.

(F) Single-use disposable sanitizer wipes shall be used in accordance with EPA-approved manufacturer's label use instructions.

~~3-304.15 Gloves, Use Limitation.~~ **3-304.15 Gloves, Use Limitation.**

(A) If used, single-use gloves shall be used for only one task such as working with ready-to-eat food or with raw animal food, used for no other purpose, and discarded when damaged or soiled, or when interruptions occur in the operation.<sup>2</sup>

(B) Except as specified in (C) of this section, slash-resistant gloves that are used to protect the hands during operations requiring cutting shall be used in direct contact only with food that is subsequently cooked as specified under Section 3-4 such as frozen food or a primal cut of meat.

(C) Slash-resistant gloves may be used with ready-to-eat food that will not be subsequently cooked if the slash-resistant gloves have a smooth, durable, and nonabsorbent outer surface; or if the slash-resistant gloves are covered with a smooth, durable, nonabsorbent glove, or a single-use glove.



(D) Cloth gloves may not be used in direct contact with food unless the food is subsequently cooked as required under Section 3-4 such as frozen food or a primal cut of meat.

~~3-304.16 Using Clean Tableware for Second Portions and Refills.~~ **3-304.16 Using Clean Tableware for Second Portions and Refills.**

(A) Except for refilling a consumer's drinking cup or container without contact between the pouring utensil and the lip-contact area of the drinking cup or container, food employees may not use tableware, including single-service articles, soiled by the consumer, to provide second portions or refills.

(B) Except as specified in (C) of this section, self-service consumers may not be allowed to use soiled tableware, including single-service articles, to obtain additional food from the display and serving equipment.

(C) Drinking cups and containers may be reused by self-service consumers if refilling is a contamination-free process as specified under 4-204.13(A), (B), and (D).

~~3-304.17 Refilling Returnables.~~ **3-304.17 Refilling Returnables.**

(A) Except as specified in (B) through (E) of this section, empty containers returned to a retail food establishment for cleaning and refilling with food shall be cleaned and refilled in a regulated food processing plant.<sup>P</sup>

(B) A take-home food container returned to a retail food establishment may be refilled at a retail food establishment with food if the food container is:

(1) Designed and constructed for reuse and in accordance with the requirements specified under Sections 4-1 and 4-2;<sup>P</sup>

(2) One that was initially provided by the retail food establishment to the consumer, either empty or filled with food by the retail food establishment, for the purpose of being returned for reuse;

(3) Returned to the retail food establishment by the consumer after use;

(4) Subject to the following steps before being refilled with food:

(a) Cleaned as specified under Section 4-6 of this regulation;

(b) Sanitized as specified under Section 4-7 of this regulation;

(c) Visually inspected by a food employee to verify that the container, as returned, meets the requirements specified under Sections 4-1 and 4-2;<sup>P</sup> ~~and~~

(C) A take-home food container returned to a retail food establishment may be refilled at a retail food establishment with beverage if:

(1) The beverage is not a time/temperature control for safety food;

(2) The design of the container, ~~and~~ of the rinsing equipment and the nature of the beverage, when considered together, allow effective cleaning at home or in the retail food establishment;

(3) Facilities for rinsing before refilling returned containers with fresh, hot water that is under pressure and not recirculated are provided as part of the dispensing system;

(4) The consumer-owned container returned to the retail food establishment for refilling is refilled for sale or service only to the same consumer; and

(5) The container is refilled by:

(a) An employee of the retail food establishment, or

(b) The owner of the container, if the beverage system includes a contamination-free transfer process as specified under 4-204.13(A), (B), and (D); that cannot be bypassed by the container owner.

(D) Consumer-owned personal take-out beverage containers, such as thermally insulated bottles, nonspill coffee cups, and promotional beverage glasses, may be refilled by employees or the consumer if refilling is a contamination-free process as specified under 4-204.13(A), (B), and (D).

(E) Consumer-owned containers that are not food-specific may be filled at a water vending machine or system.

### **3-305 Preventing Contamination from the Premises**

#### ~~3-305.11 Food Storage.~~ **3-305.11 Food Storage.**

(A) Except as specified in (B) and (C) of this section, food shall be protected from contamination by storing the food:

(1) In a clean, dry location;

(2) Where it is not exposed to splash, dust, or other contamination; and

(3) At least 15 cm (6 inches) above the floor.

(B) Food in packages and working containers may be stored less than (6) inches (15 cm) above the floor on case lot handling equipment as specified under 4-204.122.

(C) Pressurized beverage containers, cased food in waterproof containers such as bottles or cans, and milk containers in plastic crates may be stored on a floor that is clean and not exposed to floor moisture.

#### ~~3-305.12 Food Storage, Prohibited Areas.~~ **3-305.12 Food Storage, Prohibited Areas.**

Food shall not be stored:

(A) In locker rooms;

(B) In toilet rooms;

(C) In dressing rooms;

(D) In garbage rooms;

- (E) In mechanical rooms;
- (F) Under drain or sewer lines that are not shielded to intercept potential drips;
- (G) Under leaking water lines, including leaking automatic fire sprinkler heads, or under lines on which water has condensed;
- (H) Under open stairwells; or
- (I) Under other sources of contamination.

~~3-305.14 Food Preparation.~~ **3-305.14 Food Preparation.**

During preparation, unpackaged food shall be protected from environmental sources of contamination.

**3-306 Preventing Contamination by Consumers**

~~3-306.11 Food Display.~~ **3-306.11 Food Display.**

Except for nuts in the shell and whole, raw fruits and vegetables that are intended for hulling, peeling, or washing by the consumer before consumption, food on display shall be protected from contamination by the use of packaging; counter, service line, or salad bar food guards; display cases; or other effective means. <sup>lf</sup>

~~3-306.12 Condiments, Protection.~~ **3-306.12 Condiments, Protection.**

Condiments shall be protected from contamination by being kept in dispensers that are designed to provide protection, protected food displays provided with the proper utensils, original containers designed for dispensing, or individual packages or portions.

~~3-306.13 Consumer Self-Service Operations.~~ **3-306.13 Consumer Self-Service Operations.**

(A) Raw, unpackaged animal food, such as beef, lamb, pork, poultry, and fish may not be offered for consumer self-service. <sup>lf</sup>This paragraph does not apply to:

- (1) Consumer self-service of ready-to-eat foods at buffets or salad bars that serve foods such as sushi or raw shellfish;
- (2) Ready-to-cook individual portions for immediate cooking and consumption on the premises such as consumer-cooked meats or consumer-selected ingredients for Mongolian barbecue; or
- (3) Raw, frozen, shell-on shrimp, or lobster.

(B) Consumer self-service operations for ready-to-eat foods shall be provided with suitable utensils or effective dispensing methods that protect the food from contamination. <sup>pf</sup>

(C) Consumer self-service operations such as buffets and salad bars shall be monitored by food employees trained in safe operating procedures. <sup>pf</sup>

~~3-306.14 Returned Food and Re-Service of Food.~~ **3-306.14 Returned Food and Re-Service of Food**

(A) Except as specified in (B) of this section, after being served or sold and in the possession of a consumer, food that is unused or returned by the consumer may not be offered as food for human consumption. <sup>2</sup>

(B) Except as specified under 3-801.11(G), a container of food that is not a time/temperature control for safety food may be re-served from one consumer to another if:

(1) The food is dispensed so that it is protected from contamination and the container is closed between uses, such as a narrow-neck bottle containing catsup, steak sauce, or wine; or

(2) The food, such as crackers, salt, or pepper, is in an unopened original package and is maintained in sound condition.

**3-307 Preventing Contamination from Other Sources**

~~3-307.11 Miscellaneous Sources of Contamination.~~ **3-307.11 Miscellaneous Sources of Contamination.**

Food shall be protected from contamination that may result from a factor or source not specified under 3-301 through 3-306.

**3-4 Destruction of Organisms of Public Health Concern** **DESTRUCTION OF ORGANISMS OF PUBLIC HEALTH CONCERN**

**3-401 Cooking**

~~3-401.11 Raw Animal Foods.~~ **3-401.11 Raw Animal Foods.**

(A) Except as specified under (B), ~~and in (C),~~ and (D) of this section, raw animal foods such as eggs, fish, meat, poultry, and foods containing these raw animal foods, shall be cooked to heat all parts of the food to a temperature and for a time that complies with one of the following methods based on the food that is being cooked:

(1) 145 degrees F (63 degrees C) or above for fifteen (15) seconds for: <sup>2</sup>

(a) Raw eggs that are broken and prepared in response to a consumer's order and for immediate service, <sup>2</sup> and

(b) Except as specified under (A)(2) and (A)(3) and (B), and in (C) of this section, fish and intact meat including game animals commercially raised for food as specified under 3-201.17(A)(1) and game animals under a voluntary inspection program as specified under 3-201.17(A)(2); <sup>2</sup>

(2) 155 degrees F (68 degrees C) for ~~fifteen~~ seventeen (15~~7~~) seconds or the temperature specified in the following chart that corresponds to the holding time for ratites, mechanically tenderized, and injected meats; the following if they are comminuted: fish, meat, game animals commercially raised for food as specified under 3-201.17(A)(1), and game animals under a voluntary inspection program as specified under 3-201.17(A)(2); and raw eggs that are not prepared as specified under (A)(1)(a) of this section, that corresponds to that temperature in Table 3.1: <sup>2</sup>

<b>Temperature Degrees F (degrees C)</b>	<b>Time</b>
145 (63)	3 minutes
150 (66)	1 minute
158 (70)	Less than 1 second (instantaneous)

; or

(3) 165 degrees F (74 degrees C) or above for ~~fifteen~~ less than one (15) seconds (instantaneous) for poultry, baluts, wild game animals as specified under 3-201.17(A)(3) and (4), stuffed fish, stuffed meat, stuffed pasta, stuffed poultry, stuffed ratites, or stuffing containing fish, meat, poultry, or ratites.<sup>P</sup>

(B) Whole meat roasts including beef, corned beef, lamb, pork, and cured pork roasts such as ham shall be cooked:

(1) ~~In an oven that is preheated to the temperature specified for the roast's weight in the following chart and that is held at that temperature, and that corresponds to that temperature in the Table 3.2:~~ As specified in the following Table 3.2 to heat all parts of the food to a temperature and for the holding time that corresponds to that temperature:<sup>P</sup>

<b>Oven Type</b>	<b>Oven Temperature Based on Roast Weight</b>	
	<b>Less than 10 lbs (4.5 kg)</b>	<b>10 lbs (4.5 kg) or more</b>
<b>Still Dry</b>	<del>350 degrees F (177 degrees C) or more</del>	<del>250 degrees F (121 degrees C) or more</del>
<b>Convection</b>	<del>325 degrees F (163 degrees C) or more</del>	<del>250 degrees F (121 degrees C) or more</del>
<b>High Humidity</b>	<del>250 degrees F (121 degrees C) or less</del>	<del>250 degrees F (121 degrees C) or less</del>

<sup>P</sup>Relative humidity greater than 90 percent for at least 1 hour as measured in the cooking chamber or exit of the oven, or in a moisture impermeable bag that provides 100 percent humidity.

<b>Temperature Degree F (C)</b>	<b>Time in Minutes</b>	<b>Temperature Degree F (C)</b>	<b>Time in Seconds</b>
<u>130 (54.4)</u>	<u>112</u>	<u>147 (63.9)</u>	<u>134</u>
<u>131 (55.0)</u>	<u>89</u>	<u>149 (65.0)</u>	<u>85</u>
<u>133 (56.1)</u>	<u>56</u>	<u>151 (66.1)</u>	<u>54</u>
<u>135 (57.2)</u>	<u>36</u>	<u>153 (67.2)</u>	<u>34</u>
<u>136 (57.8)</u>	<u>28</u>	<u>155 (68.3)</u>	<u>22</u>
<u>138 (58.9)</u>	<u>18</u>	<u>157 (69.4)</u>	<u>14</u>
<u>140 (60.0)</u>	<u>12</u>	<u>158 (70.0)</u>	<u>0</u>
<u>142 (61.1)</u>	<u>8</u>		

144 (62.2)	5		
145 (62.8)	4		
<sup>1</sup> Holding time may include post-oven heat rise.			

; and

(2) As specified in the following chart, to heat all parts of the food to a temperature and for the holding time that corresponds to that temperature and for the holding time that corresponds to that temperature in the Table 3.3: If cooked in an oven, use an oven that is preheated to the temperature specified for the roast's weight in the following Table 3.3 and that is held at that temperature.<sup>Pr</sup>

<b>Table 3.3</b>			
<b>Temperature Degree F (C)</b>	<b>Time in Minutes</b>	<b>Temperature Degree F (C)</b>	<b>Time in Seconds</b>
130 (54.4)	112	147 (63.9)	134
131 (55.0)	89	149 (65.0)	85
133 (56.1)	56	151 (66.1)	54
135 (57.2)	36	153 (67.2)	34
136 (57.8)	28	155 (68.3)	22
138 (58.9)	18	157 (69.4)	14
140 (60.0)	12	158 (70.0)	0
142 (61.1)	8		
144 (62.2)	5		
145 (62.8)	4		
<sup>1</sup> Holding time may include post-oven heat rise.			

<b>Table 3.3</b>		
<b>Oven Type</b>	<b>Oven Temperature Based on Roast Weight</b>	
	<b>Less than 10 lbs (4.5 kg)</b>	<b>10 lbs (4.5 kg) or more</b>
<b>Still Dry</b>	350 degrees F (177 degrees C) or more	250 degrees F (121 degrees C) or more
<b>Convection</b>	325 degrees F (163 degrees C) or more	250 degrees F (121 degrees C) or more
<b>High Humidity</b>	250 degrees F (121 degrees C) or less	250 degrees F (121 degrees C) or less
<sup>1</sup> Relative humidity greater than 90 percent for at least 1 hour as measured in the cooking chamber, exit of the oven, or in a moisture-impermeable bag that provides 100 percent humidity.		

(C) A raw or undercooked whole-muscle, intact beef steak may be served or offered for sale in a ready-to-eat form if:

- (1) The food establishment serves a population that is not a highly susceptible population,
- (2) The steak is labeled to indicate that it meets the definition of "whole-muscle, intact beef" as specified under 3-201.11(E), and
- (3) The steak is cooked on both the top and bottom to a surface temperature of 145 degrees F (63 degrees C) or above and a cooked color change is achieved on all external surfaces.

(D) A raw animal food, such as raw egg, raw fish, raw-marinated fish, raw molluscan shellfish, or steak tartare, or a partially cooked food, such as lightly cooked fish, soft cooked eggs, or rare meat other than whole-muscle, intact beef steaks, as specified in (C) of this section, may be served or offered for sale upon consumer request or selection in a ready-to-eat form if:

(1) As specified under 3-801.11(C)(1) and (2), the retail food establishment serves a population that is not a highly susceptible population;

(2) The food, if served or offered for service by consumer selection from a children's menu, does not contain comminuted meat; <sup>Pf</sup> and

(3) The consumer is informed as specified under 3-603.11 that to ensure its safety, the food should be cooked as specified under (A) or (B) of this section; or

(4) The Department grants a variance from (A) or (B) of this section as specified in 8-103.10 based on a HACCP plan that:

(a) Is submitted by the permit holder and approved as specified under 8-103.11,

(b) Documents scientific data or other information showing that a lesser time and temperature regimen results in a safe food, and

(c) Verifies that equipment and procedures for food preparation and training of food employees at the retail food establishment meet the conditions of the variance.

~~3-401.12 Microwave Cooking.~~ **3-401.1 Microwave Cooking.**

Raw animal foods cooked in a microwave oven shall be:

(A) Rotated or stirred throughout or midway during cooking to compensate for uneven distribution of heat;

(B) Covered to retain surface moisture;

(C) Heated to a temperature of at least 165 degrees F (74 degrees C) in all parts of the food; <sup>P</sup> and

(D) Allowed to stand covered for two (2) minutes after cooking to obtain temperature equilibrium.

~~3-401.13 Plant Food for Cooking for Hot Holding.~~ **3-401.13 Plant Food for Cooking for Hot Holding.**

~~Fruits and vegetables~~ Plant foods that are cooked for hot holding shall be cooked to a temperature of 135 degrees F (57 degrees C). <sup>Pf</sup>

~~3-401.14 Non-Continuous Cooking of Raw Animal Foods.~~ **3-401.14 Non-Continuous Cooking of Raw Animal Foods.**

Raw animal foods that are cooked using a non-continuous cooking process shall be:

(A) Subject to an initial heating process that is no longer than sixty (60) minutes in duration; <sup>P</sup>

(B) Immediately after initial heating, cooled according to the time and temperature parameters specified for cooked time /temperature control for safety food under 3-501.14(A);<sup>2</sup>

(C) After cooling, held frozen or cold, as specified for time/temperature control for safety food under 3-501.16(A)(2);<sup>2</sup>

(D) Prior to sale or service, cooked using a process that heats all parts of the food to a temperature and for a time as specified under section 3-401.11 (A) through (C) of the regulation;<sup>2</sup>

(E) Cooled according to the time and temperature parameters specified for cooked time/temperature control for safety food under 3-501.14(A) if not either hot held as specified under 3-501.16(A), served immediately, or held using time as a public health control as specified under 3-501.19 after complete cooking;<sup>2</sup> and

(F) Prepared and stored according to written procedures that:

(1) Have obtained prior approval from the Department;<sup>2f</sup>

(2) Are maintained in the retail food establishment and are available to the Department upon request;<sup>2f</sup>

(3) Describe how the requirements specified under (A) through (E) of this section are to be monitored and documented by the permit holder and the corrective actions to be taken if the requirements are not met;<sup>2f</sup>

(4) Describe how the foods, after initial heating, but prior to complete cooking, are to be marked or otherwise identified as foods that must be cooked as specified under (D) of this section prior to being offered for sale or service;<sup>2f</sup> and

(5) Describe how the foods, after initial heating but prior to cooking as specified under (D) of this section, are to be separated from ready-to-eat foods as specified under 3-302.11 (A).<sup>2f</sup>

### **3-402 Freezing**

#### ~~3-402.11 Parasite Destruction.~~ **3-402.1 Parasite Destruction.**

(A) Except as specified in (B) of this section, before service or sale in ready-to-eat form, raw, raw-marinated, partially cooked, or marinated-partially cooked fish shall be:

(1) Frozen and stored at a temperature of -4 degrees F (-20 degrees C) or below for a minimum of one hundred sixty eight (168) hours (seven (7) days) in a freezer;<sup>2</sup>

(2) Frozen at -31 degrees F (-35 degrees C) or below until solid and stored at -31 degrees F (-35 degrees C) or below for a minimum of fifteen (15) hours;<sup>2</sup> or

(3) Frozen -31 degrees F (-35 degrees C) or below until solid and stored at -4 degrees F (-20 degrees C) or below for a minimum of twenty-four (24) hours.<sup>2</sup>

(B) Paragraph (A) of this section does not apply to:



- (1) Molluscan shellfish;
- (2) A scallop product consisting only of the shucked adductor muscle;
- (3) Tuna of the species *Thunnus alalunga*, *Thunnus albacares* (Yellowfin tuna), *Thunnus atlanticus*, *Thunnus maccoyii* (Bluefin tuna, Southern), *Thunnus obesus* (Bigeye tuna), or *Thunnus thynnus* (Bluefin tuna, Northern); or
- (4) Aquacultured fish, such as salmon, that:
  - (a) If raised in open water, are raised in net-pens, or
  - (b) Are raised in land-based operations such as ponds or tanks, and
  - (c) Are fed formulated feed, such as pellets, that contains no live parasites infective to the aquacultured fish.
- (5) Fish eggs that have been removed from the skein and rinsed.

~~3-402.12 Records, Creation and Retention.~~ **3-402.12 Records, Creation and Retention.**

(A) Except as specified in 3-402.11(B) and (B) of this section, if raw, raw-marinated, partially cooked, or marinated-partially cooked fish are served or sold in ready-to-eat form, the person in charge shall record the freezing temperature and time to which the fish are subjected and shall retain the records of the food establishment for ninety (90) calendar days beyond the time of service or sale of the fish.<sup>2f</sup>

(B) If the fish are frozen by a supplier, a written agreement or statement from the supplier stipulating that the fish supplied are frozen to a temperature and for a time specified under 3-402.11 may substitute for the records specified under (A) of this section.

(C) If raw, raw-marinated, partially cooked, or marinated-partially cooked fish are served or sold in ready-to-eat form, and the fish are raised and fed as specified in 3-402.11(B)(4), a written agreement or statement from the supplier or aquaculturist stipulating that the fish were raised and fed as specified in 3-402.11(B)(4) shall be obtained by the person in charge and retained in the records of the food establishment for ninety (90) calendar days beyond the time of service or sale of the fish.<sup>2f</sup>

**3-403 Reheating**

~~3-403.10 Preparation for Immediate Service.~~ **3-403.10 Preparation for Immediate Service.**

Cooked and refrigerated food that is fully prepared for immediate service in response to an individual consumer order, such as a roast beef sandwich au jus, may be served at any temperature.

~~3-403.11 Reheating for Hot Holding.~~ **3-403.11 Reheating for Hot Holding.**

(A) Except as specified under (B), ~~and (C)~~ and in ~~(E)~~ of this section, time/temperature control for safety food that is cooked, cooled, and reheated for hot holding shall be reheated so that all parts of the food reach a temperature of at least 165 degrees F (74 degrees C) for fifteen (15) seconds.<sup>2</sup>

(B) Except as specified under (C) of this section, time/temperature control for safety food reheated in a microwave oven for hot holding shall be reheated so that all parts of the food reach a temperature of

at least 165 degrees F (74 degrees C) and the food is rotated or stirred, covered, and allowed to stand covered for two (2) minutes after reheating.<sup>2</sup>

(C) Ready-to-eat time/temperature control for safety food that has been commercially processed and packaged in a food processing plant that is inspected by the food regulatory authority that has jurisdiction over the plant, shall be heated to a temperature of at least 135 degrees F (57 degrees C) for hot holding.<sup>2</sup>

(D) Reheating for hot holding as specified under (A) through (C) of this section shall be done rapidly and the time the food is between 41 degrees F (5 degrees C) and the temperatures specified under (A) through (C) of this section may not exceed two (2) hours.<sup>2</sup>

(E) Remaining unsliced portions of meat roasts that are cooked as specified under 3-401.11(B) may be reheated for hot holding using the oven parameters and minimum time and temperature conditions specified under 3-401.11(B).

### **3-404 Other Methods**

#### ~~3-404.11 Treating Juice~~, **3-404.11 Treating Juice**

Juice packaged in a retail food establishment shall be:

(A) Treated under a HACCP plan as specified in 8-201.14(B) through (E) to attain a 5-log reduction, which is equal to a 99.999 percent reduction, of the most resistant microorganism of public health significance;<sup>2</sup> or

(B) Labeled, if not treated to yield a 5-log reduction of the most resistant microorganism of public health significance, as specified in 21 CFR 101.17(g), *Food Labeling, Warning, Notice, and Safe Handling Statements*, products that have not been specifically processed to prevent, reduce, or eliminate the presence of pathogens with the following, "WARNING: This product has not been pasteurized and, therefore, may contain harmful bacteria that can cause serious illness in children, the elderly, and persons with weakened immune systems."<sup>2f</sup>

### ~~3-5 Limitation of Growth of Organisms of Public Health Concern~~ **LIMITATION OF GROWTH OF ORGANISMS OF PUBLIC HEALTH CONCERN**

#### ~~3-501 Temperature and Time Control~~

##### ~~3-501.11 Frozen Food~~, **3-501.1 Frozen Food.**

Stored frozen foods shall be maintained frozen.

##### ~~3-501.12 Time/Temperature Control for Safety, Slacking~~, **3-501.12 Time/Temperature Control for Safety, Slacking.**

Frozen time/temperature control for safety food that is slacked to moderate the temperature shall be held:

(A) Under refrigeration that maintains the food temperature at 41 degrees F (5 degrees C) or less; or

(B) At any temperature if the food remains frozen.

~~3-501.13 Thawing.~~ **3-501.13 Thawing.**

Except as specified in (D) of this section, time/temperature control for safety food shall be thawed:

(A) Under refrigeration that maintains the food temperature at 41 degrees F (5 degrees C) or less; or

(B) Completely submerged under cold running water:

(1) At a water temperature of 70 degrees F (21degrees C) or below,

(2) With sufficient water velocity to agitate and float off loose particles in an overflow, and

(3) For a period of time that does not allow thawed portions of ready-to-eat food to rise above 41 degrees F (5 degrees C), or

(4) For a period of time that does not allow thawed portions of a raw animal food requiring cooking as specified under 3-401.11(A) or (B) to be above 41 degrees F (5 degrees C); for more than four (4) hours including:

(a) The time the food is exposed to the running water and the time needed for preparation for cooking, or

(b) The time it takes under refrigeration to lower the food temperature to 41 degrees F (5 degrees C);

(C) As part of a cooking process if the food that is frozen is:

(1) Cooked as specified under 3-401.11(A) or (B) or 3-401.12, or

(2) Thawed in a microwave oven and immediately transferred to conventional cooking equipment; with no interruption in the process; or

(D) Using any procedure if a portion of frozen ready-to-eat food is thawed and prepared for immediate service in response to an individual consumer's order.

(E) Reduced oxygen packaged fish that bears a label indicating that it is to be kept frozen until time of use shall be removed from the reduced oxygen environment:

(1) Prior to its thawing under refrigeration as specified in (A) of this section; or

(2) Prior to; or immediately upon completion of; its thawing using procedures specified in (B) of this section.

~~3-501.14 Cooling.~~ **3-501.14 Cooling.**

(A) Cooked time/temperature control for safety food shall be cooled:

(1) Within two (2) hours from 135 degrees F (57 degrees C) to 70 degrees F (21 degrees C);<sup>2</sup>and

(2) Within a total of six (6) hours from 135 degrees F (57 degrees C) to 41 degrees F (5 degrees C) or less.<sup>2</sup>

(B) Time/temperature control for safety food shall be cooled within four (4) hours to 41 degrees F (5 degrees C) or less if prepared from ingredients at ambient temperature, such as reconstituted foods and canned tuna.<sup>2</sup>

(C) Except as specified under (D) of this section, a time/temperature control for safety food received in compliance with laws allowing a temperature above 41 degrees F (5 degrees C) during shipment from the supplier as specified in 3-202.11(B), shall be cooled within 4 hours to 41 degrees F (5 degrees C) or less;<sup>2</sup>

(D) Raw eggs shall be received as specified under 3-202.11(C) and immediately placed in refrigerated equipment that maintains an ambient air temperature of 45 degrees F (7 degrees C) or less.<sup>2</sup>

~~3-501.15 Cooling Methods.~~ **3-501.15 Cooling Methods.**

(A) Cooling shall be accomplished in accordance with the time and temperature criteria specified under 3-501.14 by using one or more of the following methods based on the type of food being cooled:

- (1) Placing the food in shallow pans;<sup>Pf</sup>
- (2) Separating the food into smaller or thinner portions;<sup>Pf</sup>
- (3) Using rapid cooling equipment;<sup>Pf</sup>
- (4) Stirring the food in a container placed in an ice water bath;<sup>Pf</sup>
- (5) Using containers that facilitate heat transfer;<sup>Pf</sup>
- (6) Adding ice as an ingredient; or<sup>Pf</sup>
- (7) Other effective methods.<sup>Pf</sup>

(B) When placed in cooling or cold holding equipment, food containers in which food is being cooled shall be:

- (1) Arranged in the equipment to provide maximum heat transfer through the container walls; and
- (2) Loosely covered or uncovered if protected from overhead contamination as specified in 3-305.11(A)(2); during the cooling period to facilitate heat transfer from the surface of the food.

~~3-501.16 Time/Temperature Control for Safety Food, Hot and Cold Holding.~~ **3-501.16 Time/Temperature Control for Safety Food, Hot and Cold Holding.**

(A) Except during preparation, cooking, or cooling, or when time is used as the public health control as specified under 3-501.19, and except as specified under (B) and in (C) of this section, time/temperature control for safety food shall be maintained:

- (1) At 135 degrees F (57 degrees C) or above, except that roasts cooked to a temperature and for a time specified in 3-401.11(B) or reheated as specified in 3-403.11(E) may be held at a temperature of 130 degrees F (54 degrees C) or above;<sup>2</sup> or

(2) At 41 degrees F (5 degrees C) or less.<sup>2</sup>

(B) Eggs that have not been treated to destroy all viable *Salmonella* shall be stored in refrigerated equipment that maintains an ambient air temperature of 45 degrees F (7 degrees C) or less.<sup>2</sup>

(C) Time/temperature control for safety food in a homogenous liquid form may be maintained outside of the temperature control requirements, as specified under (A) of this section, while contained within specially designed equipment that complies with the design and construction requirements as specified under 4-204.13(E).

~~3-501.17 Ready to Eat, Time/Temperature Control for Safety Food, Date Marking.~~ **3-501.17 Ready to Eat, Time/Temperature Control for Safety Food, Date Marking.**

(A) Except when packaging food using a reduced oxygen packaging method as specified under 3-502.12; and except as specified in (E) and (F) of this section, refrigerated, ready-to-eat, time/temperature control for safety food prepared and held in a retail food establishment for more than twenty four (24) hours shall be clearly marked to indicate the date or day by which the food shall be consumed on the premises, sold, or discarded when held at a temperature of 41 degrees F (5 degrees C) or less for a maximum of seven (7) days. The day of preparation shall be counted as Day One (1).<sup>Pf</sup>

(B) Except as specified in (E) through (G) of this section, refrigerated, ready-to-eat, time/temperature control for safety food prepared and packaged by a food processing plant shall be clearly marked, at the time the original container is opened in a retail food establishment and if the food is held for more than twenty four (24) hours, to indicate the date or day by which the food shall be consumed on the premises, sold, or discarded, based on the temperature and time combinations specified in (A) of this section and:<sup>Pf</sup>

(1) The day the original container is opened in the retail food establishment shall be counted as Day One (1);<sup>Pf</sup> and

(2) The day or date marked by the retail food establishment may not exceed a manufacturer's use-by date if the manufacturer determined the use-by date based on food safety.<sup>Pf</sup>

(C) A refrigerated, ready-to-eat, time/temperature control for safety food ingredient or a portion of a refrigerated, ready-to-eat, time/temperature control for safety food that is subsequently combined with additional ingredients or portions of food shall retain the date marking of the earliest-prepared or first-prepared ingredient.<sup>Pf</sup>

(D) A date marking system that meets the criteria stated in (A) and (B) of this section may include:

(1) Using a method approved by the Department for refrigerated, ready-to-eat time/temperature control for safety food that is frequently rewrapped, such as lunchmeat or a roast, or for which date marking is impractical, such as soft serve mix or milk in a dispensing machine;

(2) Marking the date or day of preparation, with a procedure to discard the food on or before the last date or day by which the food must be consumed on the premises, sold, or discarded as specified under (A) of this section;

(3) Marking the date or day the original container is opened in a retail food establishment, with a procedure to discard the food on or before the last date or day by which the food must be consumed on the premises, sold, or discarded as specified under (B) of this section; or

(4) Using calendar dates, days of the week, color-coded marks, or other effective marking methods, provided that the marking system is disclosed to the Department upon request.

(E) Paragraphs (A) and (B) of this section do not apply to individual meal portions served or repackaged for sale from a bulk container upon a consumer's request.

(F) Paragraphs (A) and (B) of this section do not apply to shellstock.

(G) Paragraph (B) of this section does not apply to the following foods prepared and packaged by a food processing plant inspected by the appropriate regulatory authority:

(1) Deli salads, such as ham salad, seafood salad, chicken salad, egg salad, pasta salad, potato salad, and macaroni salad, manufactured in accordance with 21 CFR 110 , *Current Good Manufacturing Practice in Manufacturing, Packing, or Holding Human Food*;

(2) Hard cheeses containing not more than thirty- nine (39) percent moisture as defined in 21 CFR 133, *Cheeses And Related Cheese Products*, cheddar, gruyere, parmesan and reggiano, and romano;

(3) Semi-soft cheeses containing more than thirty-nine (39) percent moisture, but not more than fifty (50) percent moisture, as defined in 21 CFR 133, *Cheeses And Related Cheese Products*, blue, edam, gorgonzola, gouda, and monterey jack;

(4) Cultured dairy products as defined in 21 CFR 131, *Milk And Cream*, such as yogurt, sour cream, and buttermilk;

(5) Preserved fish products, such as pickled herring and dried or salted cod, and other acidified fish products defined in 21 CFR 114, *Acidified Foods*

(6) Shelf stable, dry fermented sausages, such as pepperoni and Genoa; and

(7) Shelf stable salt-cured products such as prosciutto and Parma (ham).

~~3-501.18 Ready to Eat, Time/Temperature Control for Safety Food, Disposition.~~ **3-501.18 Ready-to-Eat, Time/Temperature Control for Safety Food, Disposition.**

A food specified in 3-501.17(A) or (B) shall be discarded if it:

(A) Exceeds the temperature and time combination specified in 3-501.17(A), except time that the product is frozen;<sup>2</sup>

(B) Is in a container or package that does not bear a date or day;<sup>2</sup> or

(C) Is appropriately marked with a date or day that exceeds a temperature and time combination as specified in 3-501.17(A).<sup>2</sup>

~~3-501.19 Time as a Public Health Control Measure~~ **3-501.19 Time as a Public Health Control Measure.**

(A) Except as specified under (D) of this section, if time without temperature control is used as the public health control for a working supply of time/temperature control for safety food before cooking, or for ready-to-eat time/temperature control for safety food that is displayed or held for sale or service:

(1) Written procedures shall be prepared in advance, maintained in the retail food establishment and made available to the Department upon request that specify:<sup>pf</sup>

(a) Methods of compliance with (B)~~(1)-(3)~~(1) through (3) or (C)~~(1)-(5)~~(1) through (5) of this section;<sup>pf</sup> and

(b) Methods of compliance with 3-501.14 for food that is prepared, cooked, and refrigerated before time is used as a public health control.<sup>pf</sup>

(B) If time without temperature control is used as the public health control up to a maximum of four (4) hours:

(1) The food shall have an initial temperature of 41 degrees F (5 degrees C) or less when removed from cold holding temperature control, or 135 degrees F (57 degrees C) or greater when removed from hot holding temperature control;<sup>p</sup>

(2) The food shall be marked or otherwise identified to indicate the time that is four (4) hours past the point in time when the food is removed from temperature control;<sup>pf</sup>

(3) The food shall be cooked and served, served at any temperature if ready-to-eat, or discarded, within four (4) hours from the point in time when the food is removed from temperature control;<sup>p</sup> and

(4) The food in unmarked containers or packages, or marked to exceed a four (4) hour limit shall be discarded.<sup>p</sup>

(C) If time without temperature control is used as the public health control up to a maximum of six (6) hours:

(1) The food shall have an initial temperature of 41 degrees F (5 degrees C) or less when removed from temperature control and the food temperature may not exceed 70 degrees F (21 degrees C) within a maximum time period of six (6) hours;<sup>p</sup>

(2) The food shall be monitored to ensure the warmest portion of the food does not exceed 70 degrees F (21 degrees C) during the six (6) hour period, unless an ambient air temperature is maintained that ensures the food does not exceed 70 degrees F (21 degrees C) during the six (6) hour holding period;<sup>pf</sup>

(3) The food shall be marked or otherwise identified to indicate:<sup>pf</sup>

(a) The time when the food is removed from 41 degrees F (5 degrees C) or less cold holding temperature control,<sup>pf</sup> and

(b) The time that is six (6) hours past the point in time when the food is removed from cold holding temperature control;<sup>pf</sup>

(4) The food shall be:

(a) Discarded if the temperature of the food exceeds 70 degrees F (21 degrees C);<sup>Pf</sup> or

(b) Cooked and served, served at any temperature if ready-to-eat, or discarded within a maximum of six (6) hours from the point in time when the food is removed from 41 degrees F (5 degrees C) or less cold holding temperature control;<sup>Pf</sup> and

(5) The food in unmarked containers or packages, or marked with a time that exceeds the six (6) hour limit shall be discarded.<sup>Pf</sup>

(D) A retail food establishment that serves a highly susceptible population may not use time as specified under (A), (B), or (C) of this section as the public health control for raw eggs.

### **3-502 Specialized Processing Methods**

#### **3-502.11 Special Processes Requiring a Variance.**

A retail food establishment shall obtain a variance from the Department as specified in 8-103.10 and under 8-103.11 before:<sup>Pf</sup>

(A) Smoking food as a method of food preservation rather than as a method of flavor enhancement;<sup>Pf</sup>

(B) Curing food;<sup>Pf</sup>

(C) Using food additives or adding components such as vinegar:<sup>Pf</sup>

(1) As a method of food preservation rather than as a method of flavor enhancement;<sup>Pf</sup> or

(2) To render a food so that it is not a time/temperature control of safety food;<sup>Pf</sup>

(D) Packaging time/temperature control for safety food using a reduced oxygen packaging method except where the growth of and toxin formation by *Clostridium botulinum* and the growth of *Listeria monocytogenes* controlled as specified under 3-502.12;<sup>Pf</sup>

(E) Custom processing animals that are for personal use as food and not for sale or service in a food establishment;<sup>Pf</sup>

(F) Preparing food by another method that is determined by the Department to require a variance;<sup>Pf</sup>

(G) Sprouting seeds or beans;<sup>Pf</sup> or

(H) Using additives or acidification when the process is for flavor enhancement only. Retail food establishments using additives or acidification for flavor enhancement only shall provide a written statement, in lieu of a HACCP plan, which shall describe foods prepared and essential safety measures implemented.



~~3-502.12 Reduced Oxygen Packaging Without a Variance, Criteria~~ **3-502.12 Reduced Oxygen Packaging Without a Variance, Criteria.**

(A) Except for a retail food establishment that obtains a variance as specified under 3-502.11, a retail food establishment that packages time/temperature control for safety food using a reduced oxygen packaging method shall control the growth and toxin formation of *Clostridium botulinum* and the growth of *Listeria monocytogenes*

(B) Except as specified under (F) of this section, a retail food establishment that packages time/temperature control for safety food using a reduced oxygen packaging method shall implement a HACCP plan that contains the information specified under 8-201.14(B)(C) and (D) and that:<sup>pf</sup>

(1) Identifies the food to be packaged;<sup>pf</sup>

(2) Except as specified under (C) through (E) of this section, requires that the packaged food shall be maintained at 41 degrees F (5 degrees C) or less and meet at least one of the following criteria:<sup>pf</sup>

(a) Has an  $A_w$  of 0.91 or less,<sup>pf</sup>

(b) Has a pH of 4.6 or less,<sup>pf</sup>

(c) Is a meat or poultry product cured at a food processing plant regulated by the USDA using substances specified in 9 CFR 424.21, ~~Use of Food Ingredients And Sources of~~ *Radiation* received in an intact package,<sup>pf</sup> or

(d) Is a food with a high level of competing organisms such as raw meat, raw poultry, or raw vegetables;<sup>pf</sup>

(3) Describes how the package shall be prominently and conspicuously labeled on the principal display panel in bold type on a contrasting background, with instructions to:<sup>pf</sup>

(a) Maintain the food at 41 degrees F (5 degrees C) or below,<sup>pf</sup> and

(b) Discard the food if within thirty (30) calendar days of its packaging it is not served for on-premises consumption, or consumed if served or sold for off-premises consumption;<sup>pf</sup>

(4) Limits the refrigerated shelf life to no more than thirty (30) calendar days from packaging to consumption, except the time the product is maintained frozen, or the original manufacturer's "sell by" or "use by" date, whichever occurs first;<sup>2</sup>

(5) Includes operational procedures that:

(a) Prohibit contacting ready-to-eat food with bare hands as specified under 3-301.11(B);<sup>pf</sup>

(b) Identify a designated work area and the method by which:<sup>pf</sup>

(i) Physical barriers or methods of separation of raw foods and ready-to-eat foods minimize cross contamination,<sup>pf</sup> and

(ii) Access to the processing equipment is limited to responsible trained personnel familiar with the potential hazards of the operation,<sup>pf</sup> and

(c) Delineate cleaning and sanitization procedures for food-contact surfaces;<sup>Pf</sup> and

(6) Describes the training program that ensures that the individual responsible for the reduced oxygen packaging operation understands the:<sup>Pf</sup>

(a) Concepts required for a safe operation,<sup>Pf</sup>

(b) Equipment and facilities,<sup>Pf</sup> and

(c) Procedures specified under (B)(5) of this section and 8-201.14 (~~BC~~) and (D).<sup>Pf</sup>

(7) Is provided to the Department prior to implementation as specified under 8-201.13 (B).

(C) Except for fish that is frozen before, during, and after packaging, and bears a label indicating that it is to be kept frozen until time of use, a retail food establishment may not package fish using a reduced oxygen packaging method.<sup>P</sup>

(D) Except as specified under (C) and (F) of this section, a retail food establishment that packages time/temperature control for safety food using a cook-chill or sous vide process shall:

(1) Provide to the Department prior to implementation a HACCP plan that contains the information as specified under 8-201.14 (~~BC~~) and (D);<sup>Pf</sup>

(2) Ensure the food is:

(a) Prepared and consumed on the premises, or prepared and consumed off the premises but within the same business entity with no distribution or sale of the packaged product to another business entity or the consumer,<sup>Pf</sup>

(b) Cooked to heat all parts of the food to a temperature and for a time as specified under 3-401.11 (A),(B), and (C);<sup>P</sup>

(c) Protected from contamination before and after cooking as specified under 3-3 and 3-4;<sup>P</sup>

(d) Placed in a package with an oxygen barrier and sealed before cooking or placed in a package and sealed immediately after cooking and before reaching a temperature below 135 degrees F (57 degrees C);<sup>P</sup>

(e) Cooled to 41 degrees F (5 degrees C) in the sealed package or bag as specified under 3-501.14 and;<sup>P</sup>

(i) Cooled to 34 degrees F (1 degrees C) within forty-eight (48) hours of reaching 41 degrees F (5 degrees C) and held at that temperature until consumed or discarded within thirty (30) days after the date of packaging;<sup>P</sup>

(ii) Held at 41 degrees F (5 degrees C) or less for no more than seven (7) days, at which time the food must be consumed or discarded;<sup>P</sup> or

(iii) Held frozen with no shelf life restriction while frozen until consumed or used.<sup>P</sup>

(f) Held in a refrigeration unit that is equipped with an electronic system that continuously monitors time and temperature and is visually examined for proper operation twice daily,<sup>Pf</sup>

(g) If transported off-site to a satellite location of the same business entity, equipped with verifiable electronic monitoring devices to ensure that times and temperatures are monitored during transportation,<sup>Pf</sup> and

(h) Labeled with the product name and the date packaged;<sup>Pf</sup> and

(3) Maintain the records required to confirm that cooling and cold holding refrigeration time/temperature parameters are required as part of the HACCP plan and:

(a) Make such records available to the Department upon request,<sup>Pf</sup> and

(b) Hold such records for at least six (6) months;<sup>Pf</sup> and

(4) Implement written operational procedures as specified under (B)(5) of this section and a training program as specified under (B)(6) of this section.<sup>Pf</sup>

(E) Except as specified under (F) of this section, a retail food establishment that packages cheese using a reduced oxygen packaging method shall:

(1) Limit the cheeses packaged to those that are commercially manufactured in a food processing plant with no ingredients added in the retail food establishment and that meet the Standards of Identity as specified in 21 CFR 133.150, *Hard Cheeses*, 21 CFR 133.169, *Pasteurized Process Cheeses*, 21 CFR 133.187, *Semisoft Cheeses*

(2) Have a HACCP plan that contains the information specified under 8-201.14 (B)(C) and (D) and as specified under (B)(1), (B)(3)(a), (B)(5), and (B)(6) of this section;<sup>Pf</sup>

(3) Labels the package on the principal display panel with a "use by" date that does not exceed thirty (30) days from its packaging or the original manufacturer's "sell by" or "use by" date, whichever occurs first;<sup>Pf</sup> and

(4) Discards the reduced oxygen packaged cheese if it is not sold for off-premises consumption or consumed within 30 calendar days of its packaging.<sup>Pf</sup>

(F) A HACCP plan is not required when a retail food establishment uses a reduced oxygen packaging method to package time/temperature control for safety food that is always:

(1) Labeled with the production time and date,

(2) Held at 41 degrees F (5 degrees C) or less during refrigerated storage, and

(3) Removed from its package in the retail food establishment within forty-eight (48) hours after packaging.

### **3-6 Food Identity, Presentation, and Consumer Advisory FOOD IDENTITY, PRESENTATION AND CONSUMER ADVISORY**

#### **3-601 Accurate Representation**

~~3-601.11 Standards of Identity.~~ **3-601.11 Standards of Identity.**

Packaged food shall comply with standard of identity requirements in 21 CFR 131-169 and 9 CFR 319, *Definitions and Standards of Identity or Composition* and general requirements in 21 CFR 130, *Food Standards: General* and 9 CFR 319 Subpart A, *General*

~~3-601.12 Honestly Presented.~~ **3-601.12 Honestly Presented.**

(A) Food shall be offered for human consumption in a way that does not mislead or misinform the consumer.

(B) Food or color additives, colored overwraps, or lights shall not be used to misrepresent the true appearance, color, or quality of a food.

**3-602 Labeling**

~~3-602.11 Food Labels.~~ **3-602.11 Food Labels.**

(A) Food packaged in a retail food establishment, shall be labeled as specified in law.

(B) Label information shall include:

(1) The common name of the food or, absent a common name, an adequately descriptive identity statement;

(2) The name and place of business of the manufacturer, packer, or distributor; and

(3) The name of the food source for each major food allergen contained in the food or a disclaimer that any major food allergen may be contained in the food.

(C) When no major food allergens are contained in the food, the food label shall state: Contains no major food allergens.

(D) Bulk food that is available for consumer self-dispensing shall be prominently labeled with the following information in plain view of the consumer:

(1) The manufacturer's or processor's label that was provided with the food or

(2) A card, sign, or other method of notification that includes the information specified under Subparagraphs (B)(1), (3), and (4) of this section.

(E) Bulk, unpackaged foods such as bakery products and unpackaged foods that are portioned to consumer specification need not be labeled if:

(1) A health, nutrient content, or other claim is not made;

(2) There are no state or local laws requiring labeling; and

(3)The food is manufactured or prepared on the premises of the retail food establishment or at another retail food establishment or a food processing plant that is owned by the same person and is regulated by the food regulatory agency that has jurisdiction.

### **3-603Consumer Advisory**

~~3-603.11 Consumption of Animal Foods that are Raw, Undercooked, or Not Otherwise Processed to Eliminate Pathogens.~~ **3-603.11Consumption of Animal Foods that are Raw, Undercooked, or Otherwise Processed to Eliminate Pathogens.**

(A) Except as specified in 3-401.11.(C), ~~and 3-401.11(D)(4), and under 3-801.11(C)~~, if an animal food, such as beef, eggs, fish, lamb, pork, poultry, or shellfish, is served or sold raw, undercooked, or without otherwise being processed to eliminate pathogens, either in ready-to-eat form or as an ingredient in another ready-to-eat food, the permit holder shall inform consumers of the significantly increased risk of consuming such foods by way of a disclosure and reminder as specified in (B) and (C) of this section using brochures, deli case or menu advisories, label statements, table tents, placards, or other effective written means. <sup>Pf</sup>

(B) Disclosure shall include:

(1) A description of the animal-derived foods, such as "oysters on the half shell (raw oysters)," "raw-egg Caesar salad," and "hamburgers (can be cooked to order)",<sup>Pf</sup> or

(2) Identification of the animal-derived foods by asterisking them to a footnote that states that the items are served raw, or undercooked, or contain (or may contain) raw or undercooked ingredients.<sup>Pf</sup>

(C) Reminder shall include asterisking the animal-derived foods requiring disclosure to a footnote that states:

(1) Regarding the safety of these items, written information is available upon request,<sup>Pf</sup>

(2) Consuming raw or undercooked meats, poultry, seafood, shellfish, or eggs may increase your risk of foodborne illness;<sup>Pf</sup> or

(3) Consuming raw or undercooked meats, poultry, seafood, shellfish, or eggs may increase your risk of foodborne illness, especially if you have certain medical conditions.<sup>Pf</sup>

(D) Packaged raw milk may be sold in packaged form provided it is bottled pursuant to the requirements of R.61-34, *Raw Milk for Human Consumption*, provided a disclosure and reminder placard that is located at the point of sale. <sup>Pf</sup>

### **3-7 Contaminated FoodCONTAMINATED FOOD**

#### **3-701Disposition**

~~3-701.11 Discarding or Reconditioning Unsafe, Adulterated, or Contaminated Food.~~ **3-701.11 Discarding or Reconditioning Unsafe, Adulterated, or Contaminated Food.**

(A) A food that is unsafe, adulterated, or not honestly presented as specified under 3-101.11 shall be discarded or reconditioned according to an approved procedure. <sup>P</sup>

(B) Food that is not from an approved source as specified under 3-201.11 through ~~3-201.17~~ shall be discarded.<sup>2</sup>

(C) Ready-to-eat food that may have been contaminated by an employee who has been restricted or excluded as specified under 2-201.12 shall be discarded.<sup>2</sup>

(D) Food that is contaminated by food employees, consumers, or other persons through contact with their hands, bodily discharges, such as nasal or oral discharges, or other means shall be discarded.<sup>2</sup>

### **~~3-8 Special Requirements For Highly Susceptible Populations~~ SPECIAL REQUIREMENTS FOR HIGHLY SUSCEPTIBLE POPULATIONS**

#### **~~3-801~~ Additional Safeguards**

#### **~~3-801.11 Pasteurized Foods, Prohibited Re-Service, and Prohibited Food.~~ 3-801.1 Pasteurized Foods, Prohibited Re-Service, and Prohibited Food.**

In a retail food establishment that serves a highly susceptible population:

(A) The following criteria shall apply to juice:

(1) For the purposes of this paragraph only, children who are age nine (9) or less and receive food in a school, day care setting, or similar facility that provides custodial care are included as highly susceptible populations;

(2) Prepackaged juice or a prepackaged beverage containing juice, that bears a warning label as specified in 21 CFR, 101.17(g) *Food Labeling, Warning, Notice, And Safe Handling Statements* that have not been specifically processed to prevent, reduce, or eliminate the presence of pathogens, or a packaged juice or beverage containing juice, that bears a warning label as specified under 3-404.11(B) may not be served or offered for sale;<sup>2</sup> and

(3) Unpackaged juice that is prepared on the premises for service or sale in a ready-to-eat form shall be processed under a HACCP plan that contains the information specified under 8-201.14(B) through (E) and as specified in 21 CFR Part 120, *Hazard Analysis and Critical Control Point (HACCP) System* Subpart B, *Pathogen Reduction*, 20.24, *Process Controls*

(B) Pasteurized eggs or egg products shall be substituted for raw eggs in the preparation of:<sup>2</sup>

(1) Foods such as Caesar salad, hollandaise or Béarnaise sauce, mayonnaise, meringue, eggnog, ice cream, and egg-fortified beverages,<sup>2</sup> and

(2) Except as specified in (F) of this section, recipes in which more than one egg is broken and the eggs are combined;<sup>2</sup>

(C) The following foods may not be served or offered for sale in a ready-to-eat form:<sup>2</sup>

(1) Raw animal foods such as raw fish, raw-marinated fish, raw molluscan shellfish, and steak tartare,<sup>2</sup>

(2) A partially cooked animal food such as lightly cooked fish, rare meat, soft-cooked eggs that are made from raw eggs, and meringue;<sup>2</sup> and

(3) Raw seed sprouts.<sup>2</sup>

(D) Food employees may not contact ready-to-eat food as specified under 3-301.11(B).<sup>2</sup>

(E) Time only, as the public health control as specified under 3-501.19(D), may not be used for raw eggs.<sup>2</sup>

(F) Subparagraph (B)(2) of this section does not apply if:

(1) The raw eggs are combined immediately before cooking for one consumer's serving at a single meal, cooked as specified under 3-401.11(A)(1), and served immediately, such as an omelet, soufflé, or scrambled eggs;

(2) The raw eggs are combined as an ingredient immediately before baking and the eggs are thoroughly cooked to a ready-to-eat form, such as a cake, muffin, or bread; or

(3) The preparation of the food is conducted under a HACCP plan that:

(a) Identifies the food to be prepared,

(b) Prohibits contacting ready-to-eat food with bare hands,

(c) Includes specifications and practices that ensure:

(i) *Salmonella* enteritidis growth is controlled before and after cooking, and

(ii) *Salmonella* enteritidis is destroyed by cooking the eggs according to the temperature and time specified in 3-401.11(A)(2),

(d) Contains the information specified under 8-201.14(D) including procedures that:

(i) Control cross contamination of ready-to-eat food with raw eggs, and

(ii) Delineate cleaning and sanitization procedures for food-contact surfaces, and

(e) Describes the training program that ensures that the food employee responsible for the preparation of the food understands the procedures to be used.

(G) Except as specified in (H) of this section, food may be re-served as specified under 3-306.14(B)(1) and (2).

(H) Food may not be re-served under the following conditions:

(1) Any food served to patients or clients who are under contact precautions in medical isolation or quarantine; or protective environment isolation may not be re-served to others outside.

(2) Packages of food from any patients, clients, or other consumers should not be re-served to persons in protective environment isolation.

## **Chapter 4 Equipment, Utensils, and Linens**

## **4-1 Materials for Construction and Repair** MATERIALS FOR CONSTRUCTION AND REPAIR

### **4-101 Multiuse**

#### ~~4-101.11 Characteristics.~~ **4-101.11 Characteristics.**

Materials that are used in the construction of utensils and food-contact surfaces of equipment may not allow the migration of deleterious substances or impart colors, odors, or tastes to food, and, under normal use conditions, utensils and food-contact surfaces shall be:<sup>2</sup>

- (A) Safe;<sup>2</sup>
- (B) Durable, corrosion-resistant, and nonabsorbent;
- (C) Sufficient in weight and thickness to withstand repeated warewashing;
- (D) Finished to have a smooth, easily cleanable surface; and
- (E) Resistant to pitting, chipping, crazing, scratching, scoring, distortion, and decomposition.

#### ~~4-101.12 Cast Iron, Use Limitation.~~ **4-101.12 Cast Iron, Use Limitation.**

(A) Except as specified in (B) and (C) of this section, cast iron may not be used for utensils or food-contact surfaces of equipment.

(B) Cast iron may be used as a surface for cooking.

(C) Cast iron may be used in utensils for serving food if the utensils are used only as part of an uninterrupted process from cooking through service.

#### ~~4-101.13 Lead, Use Limitation.~~ **4-101.13 Lead, Use Limitation.**

(A) Ceramic, china, and crystal utensils, and decorative utensils, such as hand-painted ceramic or china, that are used in contact with food shall be lead-free or contain levels of lead not exceeding acceptable limits of the following utensil categories:<sup>2</sup>

<b>Utensil Category</b>	<b>Ceramic Article Description</b>	<b>Maximum Lead mg/L</b>
Beverage Mugs, Cups, Pitchers	Coffee Mugs	0.5
Large Hollowware (excluding pitchers)	Bowls greater than or equal to 1.1 Liter (1.16 Quart)	1.0
Small Hollowware (excluding cups & mugs)	Bowls less than 1.1 Liter (1.16 Quart)	2.0
Flat Tableware	Plates, Saucers	3.0



(B) Pewter alloys containing lead in excess of 0.05 percent shall not be used as a food-contact surface.<sup>P</sup>

(C) Solder and flux containing lead in excess of 0.2 percent shall not be used as a food-contact surface.

~~4-101.14 Copper, Use Limitation.~~ **4-101.14 Copper, Use Limitation.**

(A) Except as specified in (B) of this section, copper and copper alloys such as brass may not be used in contact with a food that has a pH below six (6.0) such as vinegar, fruit juice, or wine or for a fitting or tubing installed between a backflow prevention device and a carbonator.<sup>P</sup>

(B) Copper and copper alloys may be used in contact with beer brewing ingredients that have a pH below six (6.0) in the pre-fermentation and fermentation steps of a beer brewing operation such as a brewpub or microbrewery.

~~4-101.15 Galvanized Metal, Use Limitation.~~ **4-101.15 Galvanized Metal, Use Limitation.**

Galvanized metal shall not be used for utensils or foodcontact- surfaces of equipment that are used in contact with acidic food.<sup>P</sup>

~~4-101.16 Sponges, Use Limitation.~~ **4-101.16 Sponges, Use Limitation.**

Sponges may not be used in contact with cleaned and sanitized or in-use food-contact surfaces.

~~4-101.17 Wood, Use Limitations.~~ **4-101.17 Wood, Use Limitations.**

(A) Except as specified in (B), (C), ~~and (D),~~ (E), and (F) of this section, wood and wood wicker may not be used as a food-contact surface.

(B) Hard maple or an equivalently hard, close-grained wood may be used for:

(1) Cutting boards; cutting blocks; bakers' tables; and utensils such as rolling pins, doughnut dowels, salad bowls, and chopsticks; and

(2) Wooden paddles used in confectionery operations for pressure scraping kettles when manually preparing confections at a temperature of 110 degrees C (230 degrees F) or above.

(3) Bagel boards including a laminated hardwood may be acceptable if the food-contact surface is smooth and in good repair.

(C) ~~Wicker may be used only when suitably lined.~~ Cedar planks intended for grilling fish, provided only for this purpose, and discarded after a single use.

(D) Whole, uncut, raw fruits and vegetables; and nuts in the shell may be kept in the wood shipping containers in which they were received; until the fruits, vegetables, or nuts are used.

(E) If the nature of the food requires removal of rinds, peels, husks, or shells before consumption, the whole, uncut, raw food may be kept in:

(1) Untreated wood containers; or

(2) Treated wood containers if the containers are treated with a preservative that meets the requirements specified in 21 CFR 178.3800, *Preservatives For Wood*

~~(F) Wicker may be used only when suitably lined.~~

~~4-101.18 Nonstick Coating, Use Limitation~~ **4-101.18 Nonstick Coating, Use Limitation**

Multiuse kitchenware such as frying pans, griddles, sauce pans, cookie sheets, and waffle bakers that have a perfluorocarbon resin coating shall be used with nonscoring or nonscratching utensils and cleaning aids.

~~4-101.19 Nonfood-contact Surfaces~~ **4-101.19 Nonfood-contact Surfaces.**

Nonfood-contact surfaces of equipment that are exposed to splash, spillage, or other food soiling or that require frequent cleaning, shall be constructed of a corrosion-resistant, nonabsorbent, smooth material.

~~4-102 Single-Service and Single-Use~~

~~4-102.11 Characteristics~~ **4-102.11 Characteristics.**

Materials that are used to make single-service and single-use articles:

(A) Shall not:

- (1) Allow the migration of deleterious substances,<sup>P</sup> or
- (2) Impart colors, odors, or tastes to food; and

(B) Shall be:

- (1) Safe,<sup>P</sup> and
- (2) Clean.

~~4-2 Design and Construction~~ **DESIGN AND CONSTRUCTION**

~~4-201 Durability and Strength~~

~~4.201.11 Equipment and Utensils~~ **4.201.11 Equipment and Utensils.**

Equipment and utensils shall be designed and constructed to be durable and to retain their characteristic qualities under normal use conditions.

~~4-201.12 Food Temperature Measuring Devices~~ **4-201.12 Food Temperature Measuring Devices.**

Food temperature measuring devices may not have sensors or stems constructed of glass, except that thermometers with glass sensors or stems that are encased in a shatterproof coating such as candy thermometers may be used.<sup>P</sup>

## **4-202 Cleanability**

### ~~4-202.11 Food-Contact Surfaces.~~ **4-202.1 Food-Contact Surfaces.**

(A) Multiuse food-contact surfaces shall be:

- (1) Smooth; <sup>Pf</sup>
- (2) Free of breaks; open seams; cracks, chips, inclusions, pits, and similar imperfections <sup>Pf</sup>
- (3) Free of sharp internal angles; corners, and crevices; <sup>Pf</sup>
- (4) Finished to have smooth welds and joints; <sup>Pf</sup> and

(5) Except as specified in (B) of this section, accessible for cleaning and inspection by one of the following methods:

- (a) Without being disassembled, <sup>Pf</sup> or
- (b) By disassembling without the use of tools, <sup>Pf</sup> or
- (c) By easy disassembling with the use of handheld tools commonly available to maintenance and cleaning personnel such as screwdrivers, pliers, open-end wrenches, and Allen wrenches. <sup>Pf</sup>

(B) Subparagraph (A)(5) of this section does not apply to cooking oil storage tanks, distribution lines for cooking oils, or beverage syrup lines or tubes.

### ~~4-202.12 CIP Equipment.~~ **4-202.1 CIP Equipment.**

(A) CIP equipment shall meet the characteristics specified under 4-202.11 and shall be designed and constructed so that:

- (1) Cleaning and sanitizing solutions circulate throughout a fixed system and contact all interior food-contact surfaces, <sup>Pf</sup> and
- (2) The system is self-draining or capable of being completely drained of cleaning and sanitizing solutions; and

(B) CIP equipment that is not designed to be disassembled for cleaning shall be designed with inspection access points to ensure that all interior food-contact surfaces throughout the fixed system are being effectively cleaned.

### ~~4-202.13 "V" Threads, Use Limitation.~~ **4-202.13 "V" Threads, Use Limitation.**

Except for hot oil cooking or filtering equipment, "V" type threads may not be used on food-contact surfaces.

### ~~4-202.14 Hot Oil Filtering Equipment.~~ **4-202.14 Hot Oil Filtering Equipment.**

Hot oil filtering equipment shall meet the characteristics specified under 4-202.11 or 4-202.12 and shall be readily accessible for filter replacement and cleaning of the filter.

~~4-202.15 Can Openers.~~ **4-202.15 Can Openers.**

Cutting or piercing parts of can openers shall be readily removable for cleaning and for replacement.

~~4-202.16 Nonfood-Contact Surfaces.~~ **4-202.16 Nonfood-Contact Surfaces.**

Nonfood-contact surfaces shall be free of unnecessary ledges, projections, and crevices, and designed and constructed to allow easy cleaning and to facilitate maintenance.

~~4-202.17 Kick Plates, Removable.~~ **4-202.17 Kick Plates, Removable.**

Kick plates shall be designed so that the areas behind them are accessible for inspection and cleaning by being:

(A) Removable by one of the methods specified under 4-202.11(A)(5) or capable of being rotated open; and

(B) Removable or capable of being rotated open without unlocking equipment doors.

~~4-202.18 Ventilation Hood Systems, Filters.~~ **4-202.18 Ventilation Hood Systems, Filters.**

Filters and other ~~grease-extracting~~ grease-extracting equipment shall be designed to be readily removable for cleaning and replacement if not designed to be cleaned in place.

**4-203 Accuracy**

~~4-203.11 Temperature Measuring Devices, Food.~~ **4-203.11 Temperature Measuring Devices, Food**

(A) Food temperature measuring devices that are scaled only in Celsius or dually scaled in Celsius and Fahrenheit shall be accurate to plus or minus one (1) degrees C in the intended range of use.<sup>pf</sup>

(B) Food temperature measuring devices that are scaled only in Fahrenheit shall be accurate to plus or minus two (2) degrees F in the intended range of use.<sup>pf</sup>

~~4-203.12 Temperature Measuring Devices, Ambient Air and Water.~~ **4-203.12 Temperature Measuring Devices, Ambient Air and Water.**

(A) Ambient air and water temperature measuring devices that are scaled in Celsius or dually scaled in Celsius and Fahrenheit shall be designed to be easily readable and accurate to plus or minus one point five (1.5) degrees C in the intended range of use.<sup>pf</sup>

(B) Ambient air and water temperature measuring devices that are scaled only in Fahrenheit shall be accurate to plus or minus three (3) degrees F in the intended range of use.<sup>pf</sup>

~~4-203.13 Pressure Measuring Devices, Mechanical Warewashing Equipment.~~ **4-203.13 Pressure Measuring Devices, Mechanical Warewashing Equipment.**

Pressure measuring devices that display the pressures in the water supply line for the fresh hot water sanitizing rinse shall have increments of one (1) pound per square inch (7 kilopascals) or smaller and shall

be accurate to plus or minus two (2) pounds per square inch (plus or minus 14 kilopascals) in the range indicated on the manufacturer's data plate.

#### **4-204 Functionality**

##### ~~4-204.11 Ventilation Hood Systems, Drip Prevention~~ **4-204.11 Ventilation Hood Systems, Drip Prevention.**

Exhaust ventilation hood systems in food preparation and warewashing areas including components such as hoods, fans, filters, and ducting shall be of commercial type and designed to prevent grease or condensation from draining or dripping onto food, equipment, utensils, linens, and single-service and single-use articles.

##### ~~4-204.12 Equipment Openings, Closures, and Deflectors~~ **4-204.12 Equipment Openings, Closures, and Deflectors.**

(A) A cover or lid for equipment shall overlap the opening and be sloped to drain.

(B) An opening located within the top of a unit of equipment that is designed for use with a cover or lid shall be flanged upward at least five (5) millimeters (two-tenths of an inch).

(C) Except as specified under (D) of this section, fixed piping, temperature measuring devices, rotary shafts, and other parts extending into equipment shall be provided with a watertight joint at the point where the item enters the equipment.

(D) If a watertight joint is not provided:

(1) The piping, temperature measuring devices, rotary shafts, and other parts extending through the openings shall be equipped with an apron designed to deflect condensation, drips, and dust from openings into the food; and

(2) The opening shall be flanged as specified under (B) of this section.

##### ~~4-204.13 Dispensing Equipment, Protection of Equipment and Food~~ **4-204.13 Dispensing Equipment, Protection of Equipment and Food.**

In equipment that dispenses or vends liquid food or ice in unpackaged form:

(A) The delivery tube, chute, orifice, and splash surfaces directly above the container receiving the food shall be designed in a manner, such as with barriers, baffles, or drip aprons, so that drips from condensation and splash are diverted from the opening of the container receiving the food;

(B) The delivery tube, chute, and orifice shall be protected from manual contact such as by being recessed;

(C) The delivery tube or chute and orifice of equipment used to vend liquid food or ice in unpackaged form to self-service consumers shall be designed so that the delivery tube or chute and orifice are protected from dust, insects, rodents, and other contamination by a self-closing door if the equipment is:

(1) Located in an outside area that does not otherwise afford the protection of an enclosure against the rain, windblown debris, insects, rodents, and other contaminants that are present in the environment; or

(2) Available for self-service during hours when it is not under the full-time supervision of a food employee; and

(D) The dispensing equipment actuating lever or mechanism and filling device of consumer self-service beverage dispensing equipment shall be designed to prevent contact with the lip-contact surface of glasses or cups that are refilled.

(E) Dispensing equipment in which time/temperature control for safety food in a homogenous liquid form is maintained outside of the temperature control requirements as specified under 3-501.16(A) shall:

(1) Be specifically designed and equipped to maintain the commercial sterility of aseptically packaged food in a homogenous liquid form for a specified duration from the time of opening the packaging within the equipment; <sup>2</sup>and

(2) Conform to the requirements for this equipment as specified in NSF/ANSI 18-2006, *Manual Food and Beverage Dispensing Equipment*

~~4-204.15 Bearings and Gear Boxes, Leakproof.~~ **4-204.15 Bearings and Gear Boxes, Leakproof.**

Equipment containing bearing and gears that require lubricants shall be designed and constructed so that the lubricant cannot leak, drip, or be forced into food or onto food-contact surfaces.

~~4-204.16 Beverage Tubing, Separation.~~ **4-204.16 Beverage Tubing, Separation.**

Except for cold plates that are constructed integrally with an ice storage bin, beverage tubing and cold-plate beverage cooling devices ~~shall~~may not be installed in contact with stored ice.

~~4-204.17 Ice Units, Separation of Drains.~~ **4-204.17 Ice Units, Separation of Drains.**

Liquid waste drain lines shall not pass through an ice machine or ice storage bin.

~~4-204.18 Condenser Unit, Separation.~~ **4-204.18 Condenser Unit, Separation.**

If a condenser unit is an integral component of equipment, the condenser unit shall be separated from the food and food storage space by a dustproof barrier.

~~4-204.110 Molluscan Shellfish Tanks.~~ **4-204.110 Molluscan Shellfish Tanks.**

Molluscan shellfish life support system display tanks may not be used to store or display shellfish that are offered for human consumption and shall be conspicuously marked so that it is obvious to the consumer that the shellfish are for display only. <sup>2</sup>

~~4-204.112 Temperature Measuring Devices.~~ **4-204.112 Temperature Measuring Devices.**

(A) In a mechanically refrigerated or hot food storage unit, the sensor of a temperature measuring device shall be located to measure the air temperature in the warmest part of a mechanically refrigerated unit and in the coolest part of a hot food storage unit.

(B) Except as specified in (C) of this section, cold or hot holding equipment used for time/temperature control safety food shall be designed to include and shall be equipped with at least one integral or permanently affixed temperature measuring device that is located to allow easy viewing of the device's temperature display.

(C) Paragraph (B) of this section does not apply to equipment for which the placement of a temperature measuring device is not a practical means for measuring the ambient air surrounding the food because of the design, type, and use of the equipment, such as calrod units, heat lamps, cold plates, bainmaries, steam tables, insulated food transport containers, and salad bars.

(D) Temperature measuring devices shall be designed to be easily readable.

(E) Food temperature measuring devices and water temperature measuring devices on warewashing machines shall have a numerical scale or digital readout in increments no greater than 2 degrees F (1 degreeC) in the intended range of use.<sup>pf</sup>

~~4-204.113 Warewashing Machine, Data Plate, Operating Specifications.~~ **4-204.113 Warewashing Machine, Data Plate, Operating Specifications.**

A warewashing machine shall be provided with an easily accessible and readable data plate affixed to the machine by the manufacturer that indicates the machine's design and operation specifications including the:

(A) Temperature required for washing, rinsing, and sanitizing;

(B) Pressure required for the fresh water sanitizing rinse unless the machine is designed to use only a pumped sanitizing rinse; and

(C) Conveyor speed for conveyor machines or cycle time for stationary rack machines.

~~4-204.114 Warewashing Machines, Internal Curtains.~~ **4-204.114 Warewashing Machines, Internal Curtains.**

Warewashing machine wash and rinse tanks shall be equipped with baffles, curtains, or other means to minimize internal cross contamination of the solutions in wash and rinse tanks.

~~4-204.115 Warewashing Machines, Temperature Measuring Devices.~~ **4-204.115 Warewashing Machines, Temperature Measuring Devices.**

A warewashing machine shall be equipped with a temperature measuring device that indicates the temperature of the water:

(A) In each wash and rinse tank; <sup>pf</sup> and

(B) As the water enters the hot water sanitizing final rinse manifold or in the chemical sanitizing solution tank. <sup>pf</sup>

~~4-204.116 Manual Warewashing Equipment, Heaters and Baskets.~~ **4-204.116 Manual Warewashing Equipment, Heaters and Baskets.**

If hot water is used for sanitization in manual warewashing operations, the sanitizing compartment of the sink shall be:

(A) Designed with an integral heating device, equipped with an integral thermometer, that is capable of maintaining water at a temperature not less than 171degreesF (77degreesC),<sup>pf</sup> and

(B) Provided with a rack or basket to allow complete immersion of equipment and utensils into the hot water.<sup>pf</sup>

~~4-204.117 Warewashing Machines, Automatic Dispensing of Detergents and Sanitizers.~~ **4-204.117 Warewashing Machines, Automatic Dispensing of Detergents and Sanitizers.**

A warewashing machine shall be equipped to:

(A) Automatically dispense detergents and sanitizers;<sup>pf</sup> and

(B) Incorporate a visual means to verify that detergents and sanitizers are delivered or a visual or audible alarm to signal if the detergents and sanitizers are not delivered to the respective washing and sanitizing cycles.<sup>pf</sup>

~~4-204.118 Warewashing Machines, Flow Pressure Device.~~ **4-204.118 Warewashing Machines, Flow Pressure Device.**

(A) Warewashing machines that provide a fresh hot water sanitizing rinse shall be equipped with a pressure gauge or similar device such as a transducer that measures and displays the water pressure in the supply line immediately before entering the warewashing machine; and

(B) If the flow pressure measuring device is upstream of the fresh hot water sanitizing rinse control valve, the device shall be mounted in a 6.4 millimeter or one-fourth inch Iron Pipe Size (IPS) valve.

(C) Paragraphs (A) and (B) of this section do not apply to a machine that uses only a pumped or recirculated sanitizing rinse.

~~4-204.119 Warewashing Sinks and Drainboards, Self-Draining.~~ **4-204.119 Warewashing Sinks and Drainboards, Self-Draining.**

Sinks and drainboards of warewashing sinks and machines shall be self-draining.

~~4-204.120 Equipment Compartments, Drainage.~~ **4-204.120 Equipment Compartments, Drainage.**

Equipment compartments that are subject to accumulation of moisture due to conditions such as condensation, food or beverage drip, or water from melting ice shall be sloped to an outlet that allows complete draining.

~~4-204.122 Case Lot Handling Apparatuses, Moveability.~~ **4-204.122 Case Lot Handling Apparatuses, Moveability.**



Apparatuses, such as dollies, pallets, racks, and skids used to store and transport large quantities of packaged foods received from a supplier in a cased or overwrapped lot, shall be designed to be moved by hand or by conveniently available apparatuses such as hand trucks and forklifts.

#### **4-205 Acceptability**

#### **4-205.10 Food Equipment, Certification, and Classification. ~~4-205.10 Food Equipment, Certification, and Classification.~~**

(A) Except as specified in (B) of this section, all equipment installed in a retail food establishment after the effective date of this regulation shall be certified or classified and listed to National Sanitation Foundation (NSF) / American National Standards Institute (ANSI) Commercial Food Equipment Standards, or Baking Industry Sanitation Standards Committee (BISSC), or other accredited ANSI food equipment sanitation certification recognized by the Department.

(B) Residential counter-top appliances, such as, but not limited to, coffee makers, a crockpot, toaster, toaster oven, microwave oven; and shelving, residential chest and upright freezers are exempt, but shall meet the requirements of 4-1 and 4-2.

#### **4-3 Numbers and Capacities NUMBERS AND CAPACITIES**

#### **4-301 Equipment**

#### **4-301.11 Cooling, Heating, and Holding Capacities. ~~4-301.11 Cooling Heating and Holding Capacities.~~**

Equipment for cooling and heating food, and holding cold and hot food, shall be sufficient in number and capacity to maintain food temperatures as specified under Chapter 3.<sup>pf</sup>

#### **4-301.12 Manual Warewashing, Sink Compartment Requirements. ~~4-301.12 Manual Warewashing, Sink Compartment Requirements.~~**

(A) Except as specified in (C) of this section, a sink with at least three (3) compartments shall be provided for manually washing, rinsing, and sanitizing equipment and utensils.<sup>pf</sup>

(B) Sink compartments shall be large enough to accommodate immersion of the largest equipment and utensils. If equipment or utensils are too large for the warewashing sink, a warewashing machine or alternative equipment as specified in (C) of this section shall be used.<sup>pf</sup>

(C) Alternative manual warewashing equipment may be used when there are special cleaning needs or constraints and its use is approved. Alternative manual warewashing equipment may include:

- (1) High-pressure detergent sprayers;
- (2) Low- or line-pressure spray detergent foamers;
- (3) Other task-specific cleaning equipment;
- (4) Brushes or other implements;
- (5) Two (2)-compartment sinks as specified under (D) and (E) of this section; or

(6) Receptacles that substitute for the compartments of a multicompartment sink.

(D) Before a two (2) compartment sink is used:

(1) The permit holder shall have its use approved; and

(2) The permit holder shall limit the number of kitchenware items cleaned and sanitized in the two (2) compartment sink, ~~and~~ shall limit warewashing to batch operations for cleaning kitchenware such as between cutting one type of raw meat and another or cleanup at the end of a shift, and shall:

(a) Make up the cleaning and sanitizing solutions immediately before use and drain them immediately after use, and

(b) Use a detergent-sanitizer to sanitize and apply the detergent-sanitizer in accordance with the manufacturer's label instructions and as specified under 4-501.115, or

(c) Use a hot water sanitization immersion step as specified under 4-603.16(C).

(E) A two (2) compartment sink may not be used for warewashing operations where cleaning and sanitizing solutions are used for a continuous or intermittent flow of kitchenware or tableware in an ongoing warewashing process.

#### ~~4-301.13 Drainboards~~ **4-301.13 Drainboards..**

Drainboards, utensil racks, or tables large enough to accommodate all soiled and cleaned items that may accumulate during hours of operation shall be provided for necessary utensil holding before cleaning and after sanitizing.

#### ~~4-301.14 Ventilation Hood Systems, Adequacy~~ **4-301.14 Ventilation Hood Systems, Adequacy.**

Ventilation hood systems and devices shall be sufficient in number and capacity to prevent grease or condensation from collecting on walls and ceilings.

#### ~~4-301.15 Clothes Washers and Dryers~~ **4-301.15 Clothes Washers and Dryers.**

(A) Except as specified in (B) of this section, if work clothes or linens are laundered on the premises, a mechanical clothes washer and dryer shall be provided and used.

(B) If on-premises laundering is limited to wiping cloths intended to be used moist, or wiping cloths are air-dried as specified under 4-901.12, a mechanical clothes washer and dryer need not be provided.

### **4-302 Utensils, Temperature Measuring Devices, and Testing Devices**

#### ~~4-302.11 Utensils, Consumer Self-Service~~ **4-302.11 Utensils, Consumer Self-Service.**

A food dispensing utensil shall be available for each container displayed at a consumer self-service unit such as a buffet or salad bar. <sup>Pf</sup>

#### ~~4-302.12 Food Temperature Measuring Devices~~ **4-302.12 Food Temperature Measuring Devices.**

(A) Food temperature measuring devices required for the immersion into food shall be provided and used to ensure the attainment and maintenance of food temperatures as specified under Chapter 3.<sup>Pf</sup>

(B) A temperature measuring device with a suitable small diameter probe that is designed to measure the temperature of thin masses shall be provided and readily accessible to accurately measure the temperature in thin foods such as meat patties and fish filets.<sup>Pf</sup>

~~4-302.13 Temperature Measuring Devices, Manual and Mechanical Warewashing.~~

#### **4-302.13 Temperature Measuring Devices, Manual and Mechanical Warewashing.**

(A) In manual warewashing operations, a temperature measuring device shall be provided and readily accessible for frequently measuring the washing and sanitizing temperatures.<sup>Pf</sup>

(B) In hot water mechanical warewashing operations, an irreversible registering temperature indicator shall be provided and readily accessible for measuring the utensil surface temperature.<sup>Pf</sup>

~~4-302.14 Sanitizing Solutions, Testing Devices.~~ **4-302.14 Sanitizing Solutions, Testing Devices.**

A test kit or other device that accurately measures the concentration in MG/L of sanitizing solutions shall be provided.<sup>Pf</sup>

### **4-303 Cleaning Agents and Sanitizers**

#### **4-303.11 Cleaning Agents and Sanitizers, Availability.**

(A) Cleaning agents that are used to clean equipment and utensils as specified under section 4-6 shall be provided and available for use during all hours of operation.

(B) Except for those that are generated on-site at the time of use, chemical sanitizers that are used to sanitize equipment and utensils as specified under section 4-7 shall be provided and available for use during all hours of operation.

### **4-4 Location and Installation** **LOCATION AND INSTALLATION**

#### **4-401 Location**

~~4-401.11 Equipment, Clothes Washers and Dryers, and Storage Cabinets, Contamination Prevention.~~ **4-401.11 Equipment, Clothes Washers and Dryers, and Storage Cabinets, Contamination Prevention.**

(A) Except as specified in (B) of this section, equipment, a cabinet used for the storage of food, or a cabinet that is used to store cleaned and sanitized equipment, utensils, laundered linens, and single-service and single-use articles may not be located:

- (1) In locker rooms;
- (2) In toilet rooms;
- (3) In garbage rooms;

- (4) In mechanical rooms;
- (5) Under sewer lines that are not shielded to intercept potential drips;
- (6) Under leaking water lines including leaking automatic fire sprinkler heads or under lines on which water has condensed;
- (7) Under open stairwells; or
- (8) Under other sources of contamination.

(B) A storage cabinet used for linens or single-service or single-use articles may be stored in a locker room.

(C) If a mechanical clothes washer or dryer is provided, it shall be located so that the washer or dryer is protected from contamination and only where there is no exposed food; clean equipment, utensils, and linens; and unwrapped single-service and single-use articles.

#### **4-402 Installation**

##### ~~4-402.11 Fixed Equipment, Spacing, or Sealing.~~ **4-402.11 Fixed Equipment, Spacing, or Sealing.**

(A) Equipment that is fixed in place because it is not easily movable shall be installed so that it is:

- (1) Spaced to allow access for cleaning along the sides, behind, and above the equipment;
- (2) Spaced from adjoining equipment, walls, and ceilings a distance of not more than one (1) millimeter or one thirty-second inch; or
- (3) Sealed to adjoining equipment or walls, if the equipment is exposed to spillage or seepage.

(B) Counter-mounted equipment that is not easily movable shall be installed to allow cleaning of the equipment and areas underneath and around the equipment by being:

- (1) Sealed; or
- (2) Elevated on legs as specified under 4-402.12(D).

##### ~~4-402.12 Fixed Equipment, Elevation, or Sealing.~~ **4-402.12 Fixed Equipment, Elevation, or Sealing.**

(A) Except as specified in (B) and (C) of this section, floor-mounted equipment that is not easily movable shall be sealed to the floor or elevated on legs that provide at least a six (6) inches (15 centimeters), of clearance between the floor and the equipment.

(B) If no part of the floor under the floor-mounted equipment is more than six (6) inches (15 centimeters) from the point of cleaning access, the clearance space may be only four (4) inches (10 centimeters).

(C) This section does not apply to display shelving units, display refrigeration units, and display freezer units located in the consumer shopping areas of a retail food store, if the floor under the units is maintained clean.

(D) Except as specified in (E) of this section, counter-mounted equipment that is not easily movable shall be elevated on legs that provide at least a four (4) inch (10 centimeters) clearance between the table and the equipment.

(E) The clearance space between the table and counter-mounted equipment may be:

(1) Three (3) inches (7.5 centimeters) if the horizontal distance of the table top under the equipment is no more than twenty (20) inches (50 centimeters) from the point of access for cleaning; or

(2) Two (2) inches (5 centimeters) if the horizontal distance of the table top under the equipment is no more than three (3) inches (7.5 centimeters) from the point of access for cleaning.

#### **4-5 Maintenance and Operation MAINTENANCE AND OPERATION**

##### **4-501 Equipment**

###### ~~4-501.11 Good Repair and Proper Adjustment.~~ **4-501.11 Good Repair and Proper Adjustment.**

(A) Equipment shall be maintained in a state of repair and condition that meets the requirements specified under 4-1 and 4-2.

(B) Equipment components such as doors, seals, hinges, fasteners, and kick plates shall be kept intact, tight, and adjusted in accordance with manufacturer's specifications.

(C) Cutting or piercing parts of can openers shall be kept sharp to minimize the creation of metal fragments that can contaminate food when the container is opened.

###### ~~4-501.12 Cutting Surfaces.~~ **4-501.12 Cutting Surfaces.**

Surfaces such as cutting blocks and boards that are subject to scratching and scoring shall be resurfaced if they can no longer be effectively cleaned and sanitized, or discarded if they are not capable of being resurfaced.

###### ~~4-501.14 Warewashing Equipment, Cleaning Frequency.~~ **4-501.14 Warewashing Equipment, Cleaning Frequency.**

A warewashing machine; the compartment(s) of sinks, basins, or other receptacles used for washing and rinsing equipment, utensils, raw foods, or laundering wiping cloths; and drainboards or other equipment as specified in 4-301.13 shall be cleaned:

(A) Before use;

(B) Throughout the day at a frequency necessary to prevent recontamination of equipment and utensils and to ensure that the equipment performs its intended function; and

(C) During use, at least once every twenty four (24) hours.

~~4-501.15 Warewashing Machines, Manufacturers' Operating Instructions.~~ **4-501.15 Warewashing Machines, Manufacturers' Operating Instructions.**

(A) A warewashing machine and its auxiliary components shall be operated in accordance with the machine's data plate and other manufacturer's instructions.

(B) A warewashing machine's conveyor speed or automatic cycle times shall be maintained accurately timed in accordance with manufacturer's specifications.

~~4-501.16 Warewashing Sinks and Food Preparation Sinks, Use Limitation.~~ **4-501.16 Warewashing Sinks and Food Preparation Sinks, Use Limitation.**

(A) A warewashing sink may not be used for handwashing as specified under 2-301.15.

(B) If a warewashing sink is used to wash wiping cloths, wash produce, or thaw food, the sink shall be cleaned as specified under 4-501.14 before and after each time it is used to wash wiping cloths or wash produce or thaw food. Sinks used to wash or thaw food shall be sanitized as specified under 4-7 before and after using the sink to wash produce or thaw food.

~~4-501.17 Warewashing Equipment, Cleaning Agents.~~ **4-501.17 Warewashing Equipment, Cleaning Agents.**

When used for warewashing, the wash compartment of a sink, mechanical warewasher, or wash receptacle of alternative manual warewashing equipment as specified in 4-301.12(C), shall contain a wash solution of soap, detergent, acid cleaner, alkaline cleaner, degreaser, abrasive cleaner, or other cleaning agent according to the cleaning agent manufacturer's label instructions.<sup>pf</sup>

~~4-501.18 Warewashing Equipment, Clean Solutions.~~ **4-501.18 Warewashing Equipment, Clean Solutions.**

The wash, rinse, and sanitize solutions shall be maintained clean.

~~4-501.19 Manual Warewashing Equipment, Wash Solution Temperature.~~ **4-501.19 Manual Warewashing Equipment, Wash Solution Temperature.**

The temperature of the wash solution in manual warewashing equipment shall be maintained at not less than 110 degrees F (43 degrees C) or the temperature as specified on the cleaning agent manufacturer's label instructions.<sup>pf</sup>

~~4-501.110 Mechanical Warewashing Equipment, Wash Solution Temperature.~~ **4-501.110 Mechanical Warewashing Equipment, Wash Solution Temperature.**

(A) The temperature of the wash solution in spray type warewashers that use hot water to sanitize shall not be less than:

- (1) For a stationary rack, single temperature machine, 165 degrees F (74 degrees C),<sup>pf</sup>
- (2) For a stationary rack, dual temperature machine, 150 degrees F (66 degrees C),<sup>pf</sup>
- (3) For a single tank, conveyor, dual temperature machine, 160 degrees F (71 degrees C),<sup>pf</sup> or

(4) For a multitank, conveyor, multitemperature machine, 150 degrees F (66 degrees C)<sup>pf</sup>

(B) The temperature of the wash solution in spray-type warewashers that use chemicals to sanitize may not be less than 120 degrees F (49 degrees C)<sup>pf</sup>

~~4-501.111 Manual Warewashing Equipment, Hot Water Sanitization Temperatures.~~ **4-501.111 Manual Warewashing Equipment, Hot Water Sanitization Temperatures.**

If immersion in hot water is used for sanitizing in a manual operation, the temperature of the water shall be maintained at 171 degrees F (77 degrees C) or above.<sup>p</sup>

~~4-501.112 Mechanical Warewashing Equipment, Hot Water Sanitization Temperature.~~ **4-501.112 Mechanical Warewashing Equipment, Hot Water Sanitization Temperatures.**

(A) Except as specified in (B) of this section, in a mechanical operation, the temperature of the fresh hot water sanitizing rinse as it enters the manifold may not be more than 194 degrees F (90 degrees C); or less than:<sup>pf</sup>

(1) For a stationary rack, single temperature machine, 165 degrees F (74 degrees C)<sup>pf</sup> or

(2) For all other machines, 180 degrees F (82 degrees C)<sup>pf</sup>

(B) The maximum temperature specified under (A) of this section, does not apply to the high pressure and temperature systems with wand-type, hand-held, spraying devices used for in-place cleaning and sanitizing of equipment such as meat saws.

~~4-501.113 Mechanical Warewashing Equipment, Sanitization Pressure.~~ **4-501.113 Mechanical Warewashing Equipment, Sanitization Pressure.**

The flow pressure of the fresh hot water sanitizing rinse in a warewashing machine, as measured in the water line immediately downstream or upstream from the fresh hot water sanitizing rinse control valve, shall be within the range specified on the machine manufacturer's data plate and may not be less than five (5) pounds per square inch (35 kilopascals) or more than thirty (30) pounds per square inch (200 kilopascals).

~~4-501.114 Manual and Mechanical Warewashing Equipment, Chemical Sanitization - Temperature, pH, Concentration, and Hardness.~~ **4-501.114 Manual and Mechanical Warewashing Equipment, Chemical Sanitization - Temperature, pH, Concentration, and Hardness.**

A chemical sanitizer used in a sanitizing solution for a manual or mechanical operation at contact times specified in 4-703.11(C) shall:

(A) Meet the criteria specified in 7-204.11;

(B) Be used in accordance with the EPA registered label use instructions<sup>p</sup> and

(C) Be used as follows:

(1) A chlorine solution shall have a:<sup>p</sup>

(a) Minimum temperature of 75 degrees F (24 degrees C).

- (b) Concentration between fifty (50) ppm and two hundred (200) ppm.
- (2) An iodine solution shall have a:
  - (a) Minimum temperature of 68 degrees F (20 degrees C)<sup>2</sup>
  - (b) Concentration between twelve point five (12.5) ppm and twenty five (25) ppm.<sup>2</sup>
- (3) A quaternary ammonium compound solution shall:
  - (a) Have a minimum temperature of 75 degrees F (24 degrees C)<sup>2</sup>
  - (b) Have a concentration as specified in 7-204.11 and as indicated by the manufacturer's use directions included in the labeling;<sup>2</sup> and
  - (c) Be used only in water with 500 mg/L hardness or less or in water having a hardness no greater than specified by the EPA-registered label use instructions.<sup>2</sup>
- (D) If another solution of a chemical specified under (C) of this section is used, the permit holder shall demonstrate to the Department that the solution achieves sanitization and the use of the solution shall be approved;<sup>2</sup>
- (E) If a chemical sanitizer other than chlorine, iodine, or a quaternary ammonium compound is used, it shall be approved by the EPA and applied in accordance with the EPA-registered label use instructions;<sup>2</sup>
- (F) If a chemical sanitizer is generated by a device located on-site at the retail food establishment, it shall be used as specified in (C) through (D) of this section and shall be produced by a device that:
  - (1) Complies with regulations as specified in 2(q)(1) and 12 of the *Federal Insecticide, Fungicide, and Rodenticide Act (FIFRA)*
  - (2) Complies with 40 CFR 152.500, *Requirement for Devices* and 40 CFR 156.10, *Labeling Requirements*
  - (3) Displays the EPA device manufacturing facility registration number on the device,<sup>2f</sup> and
  - (4) Is operated and maintained in accordance with manufacturer's instructions.<sup>2f</sup>

~~4-501.115 Manual Warewashing Equipment, Chemical Sanitization Using Detergent Sanitizers~~ **4-501.115 Manual Warewashing Equipment, Chemical Sanitization Using Detergent-Sanitizers**

If a detergent-sanitizer is used to sanitize in a cleaning and sanitizing procedure where there is no distinct water rinse between the washing and sanitizing steps, the agent applied in the sanitizing step shall be the same detergent-sanitizer that is used in the washing step.

~~4-501.116 Warewashing Equipment Determining Chemical Sanitizer Concentration~~ **4-501.116 Warewashing Equipment Determining Chemical Sanitizer Concentration.**



Concentration of the sanitizing solution shall be accurately determined by using a test or other device.<sup>pf</sup>

#### **4-502 Utensils and Temperature and Pressure Measuring Devices**

##### ~~4-502.11 Good Repair and Calibration.~~ **4-502.11 Good Repair and Calibration**

(A) Utensils shall be maintained in a state of repair or condition that complies with the requirements specified under 4-1 and 4-2 or shall be discarded.

(B) Food temperature measuring devices shall be calibrated in accordance with manufacturer's specifications as necessary to ensure their accuracy.<sup>pf</sup>

(C) Ambient air temperature, water pressure, and water temperature measuring devices shall be maintained in good repair and be accurate within the intended range of use.

##### ~~4-502.12 Single-Service and Single-Use Articles, Required Use.~~ **4-502.12 Single-Service and Single-Use Articles, Required Use.**

A retail food establishment without facilities specified under Section 4-6 and Section 4-7 for cleaning and sanitizing kitchenware and tableware shall provide only single-use kitchenware, single-service articles, and single-use articles for use by food employees and single-service articles for use by consumers.<sup>2</sup>

##### ~~4-502.13 Single-Service and Single-Use Articles, Use Limitations.~~ **4-502.13 Single-Service and Single-Use Articles, Use Limitations.**

(A) Single-service and ~~single-use~~ single-use articles may not be reused.

(B) A bulk milk container dispensing tube shall be cut on the diagonal leaving no more than one (1) inch protruding from the chilled dispenser head.

##### ~~4-502.14 Shells, Use Limitations.~~ **4-502.14 Shells, Use Limitations.**

Mollusk and crustacean shells may not be used more than once as serving containers.

#### ~~4-6 Cleaning of Equipment and Utensils~~ **CLEANING OF EQUIPMENT AND UTENSILS**

##### ~~4-601 Objective~~

##### ~~4-601.11 Equipment, Food Contact Surfaces, Nonfood Non-food Contact Surfaces, and Utensils.~~ **4-601.11 Equipment, Food Contact Surfaces, Nonfood Non-food Contact Surfaces, and Utensils.**

(A) Equipment food contact surfaces and utensils shall be clean to sight and touch.<sup>pf</sup>

(B) Food contact surfaces of cooking equipment and pans shall be kept free of encrusted grease deposits and other soil accumulations.

(C) ~~Non-food~~ Non-food contact surfaces shall be cleaned and kept free of an accumulation of dust, dirt, food residue, and other debris.

## 4-602 Frequency

### ~~4-602.11 Equipment Food Contact Surfaces, and Utensils.~~ **4-602.11 Equipment Food Contact Surfaces, and Utensils.**

(A) Equipment food contact surfaces and utensils shall be cleaned:

- (1) Except as specified in (B) of this section, before each use with a different type of raw animal food such as beef, fish, lamb, pork, or poultry;<sup>2</sup>
- (2) Each time there is a change from working with raw foods to working with ready-to-eat foods;<sup>2</sup>
- (3) Between uses with raw fruits and vegetables and with time/temperature control for safety food;<sup>2</sup>
- (4) Before using or storing a food temperature measuring device;<sup>2</sup> and
- (5) At any time during the operation when contamination may have occurred.<sup>2</sup>

(B) Subparagraph (A)(1) of this section does not apply if the food contact surface or utensil is in contact with a succession of different raw meats and poultry each requiring a higher cooking temperature as specified under 3-401.11 than the previous type food.

(C) Except as specified in (D) of this section, if used with time/temperature control for safety food, equipment, food-contact surfaces, and utensils shall be cleaned throughout the day at least every four (4) hours.<sup>2</sup>

(D) Surfaces of utensils and equipment contacting time/temperature control for safety food may be cleaned less frequently than every four (4) hours if:

(1) In storage, containers of time/temperature control for safety food and their contents are maintained at temperatures specified under Chapter 3 and the containers are cleaned when they are empty;

(2) Utensils and equipment are used to prepare food in a refrigerated room or area that is maintained at one of the temperatures in the following chart and:

(a) The utensils and equipment are cleaned at the frequency in the following chart that corresponds to the temperature; and

<b>Temperature</b>	<b>Cleaning Frequency</b>
5.0C <u>degrees</u> (41F <u>degrees</u> ) or less	24 hours
Greater than 5.0C <u>degrees</u> - 7.2C <u>degrees</u> (Greater than 41F <u>degrees</u> - 45F <u>degrees</u> )	20 hours
Greater than 7.2C <u>degrees</u> - 10.0C <u>degrees</u> (Greater than 45F <u>degrees</u> - 50F <u>degrees</u> )	16 hours
Greater than 10.0C <u>degrees</u> - 12.8C <u>degrees</u> (Greater than 50F <u>degrees</u> - 55F <u>degrees</u> )	10 hours

(b) The cleaning frequency based on the ambient temperature of the refrigerated room or area is documented in the retail food establishment.

(3) Containers in serving situations such as salad bars, delis, and cafeteria lines holding ready-to-eat time/temperature control for safety food that is maintained at the temperatures specified under Chapter 3, are intermittently combined with additional supplies of the same food that is at the required temperature, and the containers are cleaned at least every twenty four (24) hours;

(4) Temperature measuring devices are maintained in contact with food, such as when left in a container of deli food or in a roast, held at temperatures specified under Chapter 3;

(45) Equipment is used for storage of packaged or unpackaged food, such as a reach-in refrigerator, and the equipment is cleaned at a frequency necessary to preclude accumulation of soil residues;

(6) The cleaning schedule is based on consideration of:

(a) Characteristics of the equipment and its use,

(b) The type of food involved,

(c) The amount of food residue accumulation, and

(d) The temperature at which the food is maintained during the operation and the potential for the rapid and progressive multiplication of pathogenic or toxigenic microorganisms that are capable of causing foodborne disease; or

(57) In-use utensils are intermittently stored in a container of water in which the water is maintained at 135 degrees F (57 degrees C) or more, and the utensils and container are cleaned at least every twenty four (24) hours or at a frequency necessary to preclude accumulation of soil residues.

(E) Except when dry cleaning methods are used as specified under 4-603.11, surfaces of utensils and equipment contacting food that is not time/temperature control for safety food shall be cleaned:

(1) At any time when contamination may have occurred;

(2) At least every twenty-four (24) hours for iced tea dispensers and consumer self-service utensils such as tongs, scoops, or ladles;

(3) Before restocking consumer self-service equipment and utensils such as condiment dispensers and display containers; and

(4) In equipment such as ice bins and beverage dispensing nozzles and enclosed components of equipment such as ice makers, cooking oil storage tanks and distribution lines, beverage and syrup dispensing lines or tubes, coffee bean grinders, and water vending equipment:

(a) At a frequency specified by the manufacturer, or

(b) Absent manufacturer specifications, at a frequency necessary to preclude accumulation of soil or mold.

~~4-602.12 Cooking and Baking Equipment.~~ **4-602.12 Cooking and Baking Equipment.**

(A) The food-contact surfaces of cooking and baking equipment shall be cleaned at least every twenty four (24) hours. This section does not apply to hot oil cooking and filtering equipment if it is cleaned at a frequency specified by the manufacturer or at a frequency to preclude accumulation of soil or mold.

(B) The cavities and door seals of microwave ovens shall be cleaned at least every twenty four (24) hours by using the manufacturer's recommended cleaning procedure.

~~4-602.13 Non-food Contact Surfaces.~~ **4-602.13 Non-food-Contact Surfaces.**

~~Nonfood-contact~~ Non-food-contact surfaces of equipment shall be cleaned at a frequency necessary to preclude accumulation of soil residues.

### **4-603 Methods**

~~4-603.11 Dry Cleaning.~~ **4-603.11 Dry Cleaning.**

(A) If used, dry cleaning methods such as brushing, scraping, and vacuuming shall contact only surfaces that are soiled with dry food residues that are not a time/temperature control for safety food.

(B) Cleaning equipment used in dry cleaning food contact surfaces shall not be used for any other purpose.

~~4-603.12 Pre-cleaning.~~ **4-603.12 Pre-cleaning.**

(A) Food debris on equipment and utensils shall be ~~scraped-scraped~~ over a waste disposal unit or garbage receptacle or shall be removed in a warewashing machine with a prewash cycle.

(B) If necessary for effective cleaning, utensils and equipment shall be preflushed, presoaked, or scrubbed with abrasives.

~~4-603.13 Loading of Soiled Items, Warewashing Machines.~~ **4-603.13 Loading of Soiled Items, Warewashing Machines.**

Soiled items to be cleaned in a warewashing machine shall be loaded into racks, trays, or baskets or onto conveyors in a position that:

(A) Exposes all surfaces of the items to the unobstructed spray from all cycles; and

(B) Allows the items to drain.

~~4-603.14 Wet Cleaning.~~ **4-603.14 Wet Cleaning.**

(A) Equipment food contact surfaces and utensils shall be effectively washed to remove or completely loosen soils by using the manual or mechanical means necessary such as the application of detergents containing wetting agents and emulsifiers; acid, alkaline, or abrasive cleaners; hot water; brushes; scouring pads; high-pressure sprays; or ultrasonic devices.

(B) The washing procedures selected shall be based on the type and purpose of the equipment or utensil; and on the type of soil to be removed.

~~4-603.15 Washing, Procedures for Alternative Manual Warewashing Equipment.~~ **4-603.15 Washing, Procedures for Alternative Manual Warewashing Equipment.**

If washing in sink compartments or a warewashing machine is impractical, such as when the equipment is fixed in place or the utensils are too large, washing shall be done by using alternative manual warewashing equipment as specified in 4-301.12(C) and in accordance with the following procedures:

(A) Equipment shall be disassembled as necessary to allow access of the detergent solution to all parts;

(B) Equipment components and utensils shall be scrapped or rough cleaned to remove food particle accumulation; and

(C) Equipment and utensils shall be washed as specified in 4-603.14(A) to remove soils.

~~4-603.16 Rinsing Procedures.~~ **4-603.16 Rinsing Procedures.**

Washed utensils and equipment shall be rinsed so that abrasives are removed and cleaning chemicals are removed or diluted through the use of water or a detergent-sanitizer solution by using one of the following procedures:

(A) Use of a distinct, separate water rinse after washing and before sanitizing if using:

(1) A three (3) compartment sink;

(2) Alternative manual warewashing equipment equivalent to a three (3) compartment sink as specified in 4-301.12(C);

(3) A three (3)-step washing, rinsing, and sanitizing procedure in a warewashing system for CIP equipment;

(B) Use of a detergent-sanitizer as specified under 4-501.115 if using:

(1) Alternative warewashing equipment as specified in 4-301.12(C) that is approved for use with a detergent-sanitizer, or

(2) A warewashing system for CIP equipment;

(C) Use of a nondistinct water rinse that is integrated in the hot water sanitization immersion step of a two (2) compartment sink operation;

(D) If using a warewashing machine that does not recycle the sanitizing solution as specified under (E) of this section, or alternative manual warewashing equipment such as sprayers, use of a nondistinct water rinse that is:

(1) Integrated in the application of the sanitizing solution; and

(2) Wasted immediately after each application; or

(E) If using a warewashing machine that recycles the sanitizing solution for use in the next wash cycle, use of a nondistinct water rinse that is integrated in the application of the sanitizing solution.

## **4-7 Sanitization of Equipment and Utensils**SANITIZATION OF EQUIPMENT AND UTENSILS

### **4-701**~~Objective~~

#### ~~4-701.10 Food-Contact Surfaces and Utensils.~~ **4-701.10 Food-Contact Surfaces and Utensils.**

Equipment food-contact surfaces and utensils shall be sanitized.

### **4-702**~~Frequency~~

#### ~~4-702.11 Before Use After Cleaning.~~ **4-702.11 Before Use After Cleaning.**

Utensils and food contact surfaces of equipment shall be sanitized before use after cleaning.<sup>P</sup>

### **4-703**~~Methods~~

#### ~~4-703.11 Hot Water and Chemical.~~ **4-703.1 Hot Water and Chemical.**

After being cleaned, equipment food contact surfaces and utensils shall be sanitized in:

(A) Hot water manual operations by immersion for at least thirty (30) seconds and as specified in 4-501.111.<sup>P</sup>

(B) Hot water mechanical operations by being cycled through equipment that is set up as specified under 4-501.15, 4-501.112, and 4-501.113 and achieving a utensil surface temperature of 160 degrees F (71 degrees C) as measured by an irreversible registering temperature indicator;<sup>P</sup> or

(C) Chemical, manual, or mechanical operations, including the application of sanitizing chemicals by immersion, manual swabbing, brushing, or pressure spraying methods, using a solution as specified under 4-501.114. Contact times shall be consistent with those on EPA-registered label use instructions by providing:

(1) Except as specified under (C)(2) of this section, a contact time of at least ten (10) seconds for a chlorine solution specified under 4-501.114(C).<sup>P</sup>

(2) A contact time of at least seven (7) seconds for a chlorine solution of 50 MG/L that has a pH of ten (10.0) or less and a temperature of at least 100 degrees F (38 degrees C) or a pH of eight (8.0) or less and a temperature of at least 75 degrees F (24 degrees C).<sup>P</sup>

(3) A contact time of at least thirty (30) seconds for other chemical sanitizing solutions.<sup>P</sup> or

(4) A contact time used in relationship with a combination of temperature, concentration, and pH that, when evaluated for efficacy, yields sanitization as defined in 1-201.10(B).<sup>P</sup>

## **4-8 Laundering**LAUNDERING

## **4-801 Objective**

### ~~4-801.11 Linens.~~ **4-801.11 Linens.**

Clean linens shall be free from food residues and other soiling matter.

## **4-802 Frequency**

### ~~4-802.11 Specifications.~~ **4-802.11 Specifications.**

(A) Linens that do not come in direct contact with food shall be laundered between operations if they become wet, sticky, or visibly soiled.

(B) Cloth gloves used as specified in 3-304.15(D) shall be laundered before being used with a different type of raw animal food such as beef, fish, lamb, pork, or poultry.

(C) Linens that are used as specified in 3-304.13 and cloth napkins shall be laundered between each use.

(D) Wet wiping cloths shall be laundered daily.

(E) Dry wiping cloths shall be laundered as necessary to prevent contamination of food and clean serving utensils.

## **4-803 Methods**

### ~~4-803.11 Storage of Soiled Linens.~~ **4-803.11 Storage of Soiled Linens.**

Soiled linens shall be kept in clean, nonabsorbent receptacles or clean, washable laundry bags and stored and transported to prevent contamination of food, clean equipment, clean utensils, and single-service and ~~single-use~~ single-use articles.

### ~~4-803.12 Mechanical Washing.~~ **4-803.12 Mechanical Washing.**

(A) Except as specified in (B) of this section, linens that come in direct contact with food shall be mechanically laundered.

(B) In retail food establishments in which only wiping cloths are laundered, as specified in 4-301.15 (B), the wiping cloths may be laundered in a mechanical washer, asink designated only for wiping cloths, or a warewashing or food preparation sink that is cleaned as specified in 4-501.14.

### ~~4-803.13 Use of Laundry Facilities.~~ **4-803.13 Use of Laundry Facilities**

(A) Except as specified in (B) of this section, laundry facilities located on the premises of a retail food establishment shall be used only for the washing and drying of items used in the operation of the establishment.

(B) Separate laundry facilities located on the premises for the purpose of general laundering such as institutions providing boarding and lodging may also be used for laundering retail food establishment linens.

## **4-9 Protection of Clean ItemsPROTECTION OF CLEAN ITEMS**

### **4-901Drying**

#### **4-901.11 Equipment and Utensils, Air-Drying Required.4-901.11Equipment and Utensils, Air-Drying Required.**

After cleaning and sanitizing, equipment and utensils:

(A) Shall be air-dried or used after adequate draining as specified in the first paragraph of 40 CFR 180.940, *Tolerance Exemption for Active and Inert Ingredients for Use in Antimicrobial Formulations (Food-Contact Surface Sanitizing Solutions)* contact with food; and

(B) May not be cloth dried, except that utensils that have been air-dried may be polished with cloths that are maintained clean and dry.

#### **4-901.12 Wiping Cloths, Air-Drying Locations.4-901.12Wiping Cloths, Air-Drying Locations.**

Wiping cloths laundered in a retail food establishment that does not have a mechanical clothes dryer as specified in 4-301.15(B) shall be air-dried in a location and in a manner that prevents contamination of food, equipment, utensils, linens and single-service and single-use articles and the wiping cloths. This section does not apply if wiping cloths are stored after laundering in a sanitizing solution as specified under 4-501.114.

### **4-902Lubricating and Reassembling**

#### **4-902.11 Food Contact Surfaces.4-902.1Food-Contact Surfaces.**

Lubricants as specified under 7-205.11 shall be applied to food contact surfaces that require lubrication in a manner that does not contaminate food contact surfaces.

#### **4-902.12 Equipment.4-902.1Equipment.**

Equipment shall be reassembled so that food contact surfaces are not contaminated.

### **4-903Storing**

#### **4-903.11 Equipment, Utensils, Linens, and Single-Service and Single-Use Articles.4-903.11Equipment, Utensils, Linens, and Single-Service and Single-Use Articles.**

(A) Except as specified in (D) of this section, Cleaned equipment and utensils, laundered linens and single-service and single-use articles shall be stored:

- (1) In a clean, dry location; and
- (2) Where they are not exposed to splash, dust, or other contamination; and
- (3) At least six (6) inches (15 ~~em~~centimeters) above the floor.

(B) Clean equipment and utensils shall be stored as specified in (A) of this section and shall be stored:



- (1) In a self-draining position that allows for air drying; and
- (2) Covered or inverted.

(C) Single-service and single-use articles shall be stored as specified under (A) of this section and shall be kept in the original protective package or stored by using other means that afford protection from contamination until used.

(D) Items that are kept in closed packages shall be stored less than six (6) inches (15 centimeters) above the floor on dollies, pallets, racks, and skids that are designed as specified under 4-204.122.

#### ~~4-903.12 Prohibitions.~~ **4-903.12 Prohibitions.**

(A) Except as specified in (B) of this section, cleaned and sanitized equipment, utensils, laundered linens, and single-service and single-use articles shall not be stored:

- (1) In locker rooms;
- (2) In toilet rooms;
- (3) In garbage rooms;
- (4) In mechanical rooms;
- (5) Under sewer lines that are not shielded to intercept potential drips;
- (6) Under leaking water lines including leaking automatic fire sprinkler heads or under lines on which water has condensed;
- (7) Under open stairwells; or
- (8) Under other sources of contamination.

(B) Laundered linens and single-service and single-use articles that are packaged or in a facility such as a cabinet may be stored in a locker room.

#### **4-904 Preventing Contamination**

##### ~~4-904.11 Kitchenware and Tableware.~~ **4-904.1 Kitchenware and Tableware.**

(A) Single-service and single-use articles and cleaned and sanitized utensils shall be handled, displayed, and dispensed so that contamination of food- and lip-contact surfaces is prevented.

(B) Knives, forks, and spoons that are not ~~pre-wrapped~~ pre-wrapped shall be presented so that only the handles are touched by employees and by consumers if consumer self-service is provided.

(C) Except as specified in (B) of this section, single-service articles that are intended for food- or lip-contact shall be furnished for consumer self-service with the original individual wrapper intact or from an approved dispenser.

~~4-904.12 Soiled and Clean Tableware.~~ **4-904.12 Soiled and Clean Tableware.**

Soiled tableware shall be removed from consumer eating and drinking areas and handled so that clean tableware is not contaminated.

~~4-904.13 Preset Tableware.~~ **4-904.13 Preset Tableware.**

(A) Except as specified in (B) of this section, tableware that is preset shall be protected from contamination by being wrapped, covered, or inverted.

(B) Preset tableware may be exposed if:

- (1) Unused settings are removed when a consumer is seated; or
- (2) Settings not removed when a consumer is seated are cleaned and sanitized before further use.

~~4-904.14 Rinsing Equipment and Utensils after Cleaning and Sanitizing.~~ **4-904.14 Rinsing Equipment and Utensils after Cleaning and Sanitizing.**

After being cleaned and sanitized, equipment and utensils shall not be rinsed before air-drying or use unless:

(A) The rinse is applied directly from a potable water supply by a warewashing machine that is maintained and operated as specified under 4-204 and 4-501; and

(B) The rinse is applied only after the equipment and utensils have been sanitized by the application of hot water or by the application of a chemical sanitizer solution whose EPA registered label use instructions call for rinsing off the sanitizer after it is applied in a commercial warewashing machine.

## **Chapter 5 Water, Plumbing, and Waste**

### **5-1 Water**

#### **5-101 Source**

~~5-101.11 Approved System.~~ **5-101.11 Approved System.**

Drinking water shall be obtained from an approved source that is:

(A) An existing public water system<sup>P</sup> (e.g., municipality);

(B) A new public water system (including a well) constructed for the purpose of serving the retail food establishment that is constructed, maintained, and operated according to R.61-58 *State Primary Drinking Water Regulation*

(1) The owner shall provide the Department with a copy of the public water system *Operating Permit, Public Water Supply Construction Permit and Approval to Place into Operation* upon issuance of a permit to operate the retail food establishment;

(2) Upon the date of written notification from the Department to the owner/retail food establishment that the water supply to the retail food establishment does not meet acceptable standards for drinking water consumption, the retail food establishment shall immediately cease its food operation<sup>2</sup>

(C) An approved water transport vehicle, filled from a source that complies with (A) or (B) above<sup>2</sup>

(D) An approved water container, filled from a source that complies with (A) or (B) above<sup>2</sup> or

(E) An on-premises water storage tank, filled from a source that complies with (A) or (B) above<sup>2</sup>

~~5-101.12 System Flushing and Disinfection~~ **5-101.12 System Flushing and Disinfection.**

A drinking water system shall be flushed and sampled for the presence of bacteria before being placed in service after construction, repair, or modification and after an emergency situation, such as a flood, or a water main break, that may introduce contaminants to the system.<sup>2</sup>

~~5-101.13 Bottled Drinking Water~~ **5-101.13 Bottled Drinking Water.**

Bottled drinking water used or sold in a retail food establishment shall be obtained from approved sources in accordance with 21 CFR 129, *Processing and Bottling of Bottled Drinking Water* .

**5-102 Quality**

~~5-102.11 Standards~~ **5-102.11 Standards.**

Water from a public water system shall meet 40 CFR 141, *National Primary Drinking Water Regulations* and R.61-58, *State Primary Drinking Water Regulations*

~~5-102.12 Nondrinking Water~~ **5-102.12 Nondrinking Water.**

(A) A nondrinking water supply shall be used only if its use is approved.<sup>2</sup>

(B) Nondrinking water shall be used only for nonculinary purposes such as air conditioning, nonfood equipment cooling, and fire protection.<sup>2</sup>

~~5-102.13 Sampling~~ **5-102.13 Sampling**

Except when used as specified under 5-102.12, water from a public water system shall be sampled and tested at least annually and as required by R.61-58, *State Primary Drinking Water Regulations*.

~~5-102.14 Sampling Report~~ **5-102.14 Sampling Report.**

The most recent sample report for the public water system shall be maintained as specified by R.61-58, *State Primary Drinking Water Regulations*

**5-103 Quantity and Availability**

~~5-103.11 Capacity~~ **5-103.11 Capacity.**

(A) The water source and system shall be of sufficient capacity to meet the peak water demands of the retail food establishment.<sup>Pf</sup>

(B) Hot water generation and distribution systems shall be sufficient to meet the peak hot water demands throughout the retail food establishment.<sup>Pf</sup> ~~It is required that the hot water system for retail food service establishments be a dedicated hot water system, separate from other hot water fixtures and demands, such as but not limited to, motel and hotel guest rooms, showers, laundries, hot tubs, jacuzzis, manufacturing industry fixtures and equipment, and school classrooms.~~

~~5-103.12 Pressure.~~ **5-103.12 Pressure.**

Water under pressure shall be provided to all fixtures, equipment, and nonfood equipment that are required to use water except that water supplied as specified under 5-104.12(A) and (B) in response to a temporary interruption of a water supply need not be under pressure.<sup>Pf</sup>

~~5-104 Distribution, Delivery, and Retention~~ **5-104 Distribution, Delivery, and Retention**

~~5-104.11 System.~~ **5-104.11 System.**

Water shall be received from the source through the use of:

- (A) An approved public water main; <sup>Pf</sup> or
- (B) One or more of the following that shall be constructed, maintained, and operated according to law: <sup>Pf</sup>
  - (1) Water pumps, pipes, hoses, connections, and other appurtenances; <sup>Pf</sup>
  - (2) Water transport vehicles; <sup>Pf</sup> or
  - (3) Water containers. <sup>Pf</sup>

~~5-104.12 Alternative Water Supply.~~ **5-104.12 Alternative Water Supply.**

Water meeting the requirements specified under 5-101, 5-102, and 5-103 shall be made available for a mobile facility, for a temporary food establishment without a permanent water supply, and for a retail food establishment with a temporary interruption of its water supply through:

- (A) A supply of containers of commercially bottled drinking water; <sup>Pf</sup>
- (B) One or more closed portable water containers; <sup>Pf</sup>
- (C) An enclosed vehicular water tank; <sup>Pf</sup>
- (D) An on-premises water storage tank; <sup>Pf</sup> or
- (E) Piping, tubing, or hoses connected to an adjacent approved source. <sup>Pf</sup>

~~5-2 Plumbing System~~ **5-2 PLUMBING SYSTEM**

~~5-201 Materials~~ **5-201 Materials**

~~5-201.11 Approved~~ **5-201.11 Approved**

(A) A plumbing system and hoses conveying water shall be constructed and repaired with approved materials according to the law.<sup>L</sup>

(B) A water filter shall be made of safe materials.<sup>L</sup>

**5-202 Design, Construction, and Installation**

~~5-202.11 Approved System and Cleanable Fixtures~~ **5-202.11 Approved System and Cleanable Fixtures**.

(A) A plumbing system shall be designed, constructed, and installed according to law.<sup>L</sup>

(B) A plumbing fixture such as a handwashing sink, toilet, or urinal shall be easily cleanable.

~~5-202.12 Handwashing Sink, Installation~~ **5-202.12 Handwashing Sink, Installation**.

(A) A handwashing sink shall be equipped to provide water at a temperature of at least 100 degrees F (38 degrees C) through a mixing valve or combination faucet.<sup>Pf</sup>

(B) A steam mixing valve may not be used at a handwashing sink.

(C) A self-closing, slow-closing, or metering faucet shall provide a flow of water for at least fifteen (15) seconds without the need to reactivate the faucet.

(D) An automatic handwashing facility shall be installed in accordance with manufacturer's instructions.

~~5-202.13 Backflow Prevention, Air Gap~~ **5-202.13 Backflow Prevention, Air Gap**.

An air gap between the water supply inlet and the flood level rim of the plumbing fixture, equipment, or nonfood equipment shall be at least twice the diameter of the water supply inlet and may not be less than one (1) inch (25 mm).<sup>L</sup>

~~5-202.14 Backflow Prevention Device, Design Standard~~ **5-202.14 Backflow Prevention Device, Design Standard**.

A backflow prevention device installed on the internal water supply system shall meet American Society of Sanitary Engineering (A.S.S.E.) standards for construction, installation, maintenance, inspection, and testing standards specified by the public water system supplying water to the retail food establishment for that specific application and type of device.<sup>P</sup>

~~5-202.15 Conditioning Device, Design~~ **5-202.15 Conditioning Device, Design**.

A water filter, screen, and other water conditioning device installed on water lines shall be designed to facilitate disassembly for periodic servicing and cleaning. A water filter element shall be of the replaceable type.

**5-203 Numbers and Capacities**

~~5-203.11 Handwashing Sinks.~~ **5-203.11 Handwashing Sinks.**

(A) Except as specified in (B) of this section, at least one (1) handwashing sink, ~~a number of handwashing sinks~~ necessary for their convenient use by employees in areas specified under 5-204.11 shall be provided. Additional handwashing sinks may be required based on the size and operational flow of the establishment. ~~and There shall not be fewer than the number of handwashing sinks required by law.~~ ~~shall be provided.~~

(B) If approved and capable of removing the types of soils encountered in the food operations involved, automatic handwashing facilities may be substituted for handwashing sinks in a retail food establishment that has a least one (1) handwashing sink.

~~5-203.12 Toilets and Urinals.~~ **5-203.12 Toilets and Urinals.**

At least one (1) toilet, and not fewer than the toilets required by law, shall be provided. If authorized by law and urinals are substituted for toilets, the substitution shall be done as specified in law.

~~5-203.13 Service Sink.~~ **5-203.13 Service Sink.**

(A) At least one (1) service sink or one (1) curbed cleaning facility equipped with a floor drain shall be provided and conveniently located for the cleaning of mops or similar wet floor cleaning tools and for the disposal of mop water and similar liquid waste.

(B) Toilets and urinals may not be used as a service sink for the disposal of mop water and similar liquid waste.

~~5-203.14 Backflow Prevention Device, When Required.~~ **5-203.14 Backflow Prevention Device, When Required.**

A plumbing system shall be installed to preclude backflow of a solid, liquid, or gas contaminant into the water supply system at each point of use at the retail food establishment, including on a hose bibb if a hose is attached or on a hose bibb if a hose is not attached and backflow prevention is required by law, by:

(A) Providing an air gap as specified under 5-202.13,<sup>p</sup> or

(B) Installing an approved backflow prevention device as specified under 5-202.14<sup>p</sup>

~~5-203.15 Backflow Prevention Device, Carbonator.~~ **5-203.15 Backflow Prevention Device, Carbonator.**

(A) If not provided with an approved air gap as specified under 5-202.13, a dual check valve with an intermediate vent preceded by a screen of not less than one hundred (100) mesh to one (1) inch (100 mesh to 25.4 mm) shall be installed upstream from a carbonating device and downstream from any copper in the water supply line.<sup>p</sup>

(B) A dual check valve attached to the carbonator need not be of the vented type if an air gap or vented backflow prevention device has been otherwise provided as specified in (A) of this section.

**5-204 Location and Placement**

~~5-204.11 Handwashing Sinks.~~ **5-204.11 Handwashing Sinks.**

A handwashing sink shall be located:

(A) To allow convenient use by employees, in food preparation, food dispensing, and warewashing areas;<sup>pf</sup> and

(B) In, or immediately adjacent to, toilet rooms.<sup>pf</sup>

~~5-204.12 Backflow Prevention Device, Location.~~ **5-204.12 Backflow Prevention Device, Location.**

A backflow prevention device shall be located so that it may be serviced and maintained.

~~5-204.13 Conditioning Device, Location.~~ **5-204.13 Conditioning Device, Location.**

A water filter, screen, and other water conditioning device installed on water lines shall be located to facilitate disassembly for periodic servicing and cleaning.

## **5-205 Operation and Maintenance**

~~5-205.11 Using a Handwashing Sink.~~ **5-205.11 Using a Handwashing Sink.**

(A) A handwashing sink shall be maintained so that it is accessible at all times for employee use.<sup>pf</sup>

(B) A handwashing sink shall not be used for purposes other than handwashing.<sup>pf</sup>

(C) An automatic handwashing facility shall be used in accordance with manufacturer's instructions.<sup>pf</sup>

~~5-205.12 Prohibiting a Cross Connection.~~ **5-205.12 Prohibiting a Cross Connection.**

(A) A person may not create a cross connection by connecting a pipe or conduit between the drinking water system and a nondrinking water system or a water system of unknown quality.<sup>p</sup>

(B) The piping of a nondrinking water system shall be durably identified so that it is readily distinguishable from piping that carries drinking water.<sup>pf</sup>

~~5-205.13 Scheduling Inspection and Service for a Water System Device.~~ **5-205.13 Scheduling Inspection and Service for a Water System Device.**

A device such as a water treatment device or backflow prevention device shall be scheduled for inspection and service; in accordance with manufacturer's instructions and as necessary to prevent device failure based on local water conditions, and records demonstrating inspection and service shall be maintained by the person in charge.<sup>pf</sup>

~~5-205.14 Water Reservoir of Fogging Devices, Cleaning.~~ **5-205.14 Water Reservoir of Fogging Devices, Cleaning.**

(A) A reservoir that is used to supply water to a device such as a produce fogger shall be:

(1) Maintained in accordance with manufacturer's specifications,<sup>p</sup> and

(2) Cleaned in accordance with manufacturer's specifications or according to the procedures specified in (B) of this section, whichever is more stringent.<sup>P</sup>

(B) Cleaning procedures shall include at least the following steps and shall be conducted at least once a week:

(1) Draining and complete disassembly of the water and aerosol contact parts;<sup>P</sup>

(2) Brush-cleaning the reservoir, aerosol tubing, and discharge nozzles with a suitable detergent solution;<sup>P</sup>

(3) Flushing the complete system with water to remove the detergent solution and particulate accumulation;<sup>P</sup> and

(4) Rinsing by immersing, spraying, or swabbing the reservoir, aerosol tubing, and discharge nozzles with at least 50 mg/l hypochlorite solution.<sup>P</sup>

~~5-205.15 System Maintained in Good Repair~~ **5.205.15 System Maintained in Good Repair.**

A plumbing system shall be:

(A) Repaired according to law;<sup>P</sup> and

(B) Maintained in good repair.

### **5-3 Mobile Water Tank and Mobile Food Establishment Water Tank** **MOBILE WATER AND MOBILE FOOD ESTABLISHMENT WATER TANK**

#### **5-301 Materials**

~~5-301.11 Approved~~ **5-301.11 Approved.**

Materials that are used in the construction of a mobile water tank, mobile food establishment water tank, and appurtenances shall comply with NSF 372 and shall have a weighted average lead content of 0.25 percent or less and meet either ANSI/NSF Standard 59 or 61.<sup>P</sup>

#### **5-302 Design and Construction**

~~5-302.11 Enclosed System, Sloped to Drain~~ **5-302.11 Enclosed System, Sloped to Drain.**

A mobile water tank shall be:

(A) Enclosed from the filling inlet to the discharge outlet; and

(B) Sloped to an outlet that allows complete drainage of the tank.

~~5-302.12 Inspection and Cleaning Port, Protected and Secured~~ **5-302.12 Inspection and Cleaning Port, Protected and Secured.**



If a water tank is designed with an access port for inspection and cleaning, the opening shall be in the top of the tank and:

- (A) Flanged upward at least one-half inch (13 mm); and
- (B) Equipped with a port cover assembly that is:
  - (1) Provided with a gasket and a device for securing the cover in place; and
  - (2) Flanged to overlap the opening and sloped to drain.

~~5-302.13 "V" Type Threads, Use Limitation.~~ **5-302.13 "V" Type Threads, Use Limitation.**

A fitting with "V" type threads on a water tank inlet or outlet shall be allowed only when a hose is permanently attached.

~~5-302.14 Tank Vent, Protected.~~ **5-302.14 Tank Vent, Protected.**

If provided, a water tank vent shall terminate in a downward direction and shall be covered with:

- (A) Sixteen (16) mesh to one (1) inch (25.4 mm) screen or equivalent when the vent is in a protected area; or
- (B) A protective filter when the vent is in an area that is not protected from windblown dirt and debris.

~~5-302.15 Inlet and Outlet, Sloped to Drain.~~ **5-302.15 Inlet and Outlet, Sloped to Drain.**

- (A) A water tank and its inlet and outlet shall be sloped to drain.
- (B) A water tank inlet shall be positioned so that it is protected from contaminants such as waste discharge, road dust, oil, or grease.

~~5-302.16 Hose, Construction, and Identification.~~ **5-302.16 Hose, Construction, and Identification.**

A hose used for conveying drinking water from a water tank shall be:

- (A) Safe; <sup>p</sup>
- (B) Durable, corrosion resistant, and nonabsorbent;
- (C) Resistant to pitting, chipping, crazing, scratching, scoring, distortion, or decomposition;
- (D) Finished with a smooth interior surface; and
- (E) Clearly and durably identified as to its use if not permanently attached.

## **~~5-303~~Numbers and Capacities**

~~5-303.11 Filter, Compressed Air.~~ **5-303.11 Filter, Compressed Air.**

A filter that does not pass oil or oil vapors shall be installed in the air supply line between the compressor and drinking water system when compressed air is used to pressurize the water tank system.<sup>2</sup>

~~5-303.12 Protective Cover or Device.~~ **5-303.12 Protective Cover or Device.**

A cap and keeper chain, closed cabinet, closed storage tube, or other approved protective cover or device shall be provided for a water inlet, outlet, and hose.

~~5-303.13 Mobile Food Establishment Tank Inlets.~~ **5-303.13 Mobile Food Establishment Tank Inlets.**

A mobile food establishment water tank inlet shall be:

- (A) Nineteen point one (19.1) mm (three-fourths inch) in inner diameter or less; and
- (B) Provided with a hose connection of a size or type that will prevent its use for any other service.

**5-304 Operation and Maintenance**

~~5-304.11 System Flushing and Sanitization.~~ **5-304.11 System Flushing and Sanitization.**

A water tank, pump, and hoses shall be flushed and sanitized before being placed in service after construction, repair, modification, and periods of non-use.<sup>2</sup>

~~5-304.12 Using a Pump and Hoses, Backflow Prevention.~~ **5-304.12 Using a Pump and Hoses, Backflow Prevention.**

A person shall operate a water tank, pump, and hoses so that backflow and other contamination of the water supply are prevented.

~~5-304.13 Protecting Inlet, Outlet, and Hose Fitting.~~ **5-304.13 Protecting Inlet, Outlet, and Hose Fitting.**

If not in use, a water tank and hose inlet and outlet fitting shall be protected using a cover or device as specified in 5-303.12.

~~5-304.14 Tank, Pump, and Hoses, Dedication.~~ **5-304.14 Tank, Pump, and Hoses, Dedication.**

(A) Except as specified in (B) of this section, a water tank, pump, and hoses used for conveying drinking water shall be used for no other purpose.<sup>2</sup>

(B) Water tanks, pumps, and hoses approved for liquid foods may be used for conveying drinking water if they are cleaned and sanitized before they are used to convey water.

**5-4 Sewage, Other Liquid Waste, and Rainwater** **SEWAGE, OTHER LIQUID WASTE, AND RAINWATER**

**5-401 Mobile Holding Tank**

~~5-401.11 Capacity and Drainage.~~ **5-401.1 Capacity and Drainage.**

A sewage holding tank in a mobile food establishment shall be:

(A) Sized fifteen (15) percent larger in capacity than the water supply tank; and

(B) Sloped to a drain that is one (1) inch (25 mm) in inner diameter or greater, and equipped with a shut-off valve.

**5-402 Retention, Drainage, and Delivery**

~~5-402.10 Establishment Drainage System.~~ **5-402.10 Establishment Drainage System.**

Retail food establishment drainage systems, including grease traps, that convey sewage, shall be designed and installed as specified under 5-202.11(A).

~~5-402.11 Backflow Prevention.~~ **5-402.11 Backflow Prevention.**

(A) Except as specified in (B), (C), and (D) of this section, a direct connection may not exist between the sewage system and a drain originating from equipment in which food, portable equipment, or utensils are placed.<sup>2</sup>

(B) Paragraph (A) of this section does not apply to floor drains that originate in refrigerated spaces that are constructed as an integral part of the building.

(C) If allowed by law, a warewashing machine may have a direct connection between its waste outlet and a floor drain when the machine is located within five (5) feet (1.5 m) of a trapped floor drain and the machine outlet is connected to the inlet side of a properly vented floor drain trap.

(D) If allowed by law, a warewashing or culinary sink may have a direct connection.

~~5-402.12 Grease Traps and Grease Interceptors.~~ **5-402.12 Grease Traps and Grease Interceptors.**

If used, a grease trap or grease interceptor shall be located to be easily accessible for cleaning.

(A) Grease Traps.

(1) When required by the sewer purveyor, grease traps shall be located outside to be easily accessible for cleaning and servicing, except when the building is the property line; a grease trap may be installed inside a retail food establishment, provided the grease trap complies as specified in (2), (3), and (4) of this section.

(2) Grease traps shall not be installed in food preparation areas, food storage areas, equipment and utensil washing areas, food dispensing areas, or in areas where food equipment and single-service articles are stored.

(3) Grease trap servicing hoses and pumps shall not run through food preparation areas, food storage areas, equipment and utensil washing areas, food dispensing areas, or in areas where food equipment and single-service articles are stored.

(4) Facilities with existing grease traps that are located in food preparation areas, food storage areas, equipment and utensil washing areas, or food dispensing areas, prior to the effective date of this regulation, which require inspection, servicing, or maintenance, shall:

(a) Temporarily close for business and shall cease all food preparation and utensils washing activities during inspection, servicing, or maintenance of the grease trap; and

(b) Immediately after inspection, servicing, or maintenance, clean and sanitize the grease trap area and adjacent surfaces before re-opening for business and resuming food service activities.

(B) Grease Interceptors.

(1) When required by the sewer purveyor, grease interceptors may be installed in food preparation, food storage, equipment, and utensil washing areas.

(2) Grease interceptors on the floor shall have a minimum unobstructed clearance of twenty-four (24) inches above the interceptors to allow access for servicing and maintenance, and shall have a minimum of six (6) inch spacing to walls or adjacent surfaces to allow access for cleaning around the grease interceptor.

(3) Grease interceptors fully recessed or recessed with an extension to floor level shall not have equipment placed on top of the unit and shall have a minimum unobstructed clearance of twenty-four (24) inches above the grease interceptor, except for floor-mounted equipment that is mobile or portable.

(4) Grease interceptors shall be manually serviced. Grease servicing hoses and pumps are prohibited in food preparation areas, food storage areas, equipment and utensil washing areas, food dispensing areas, or in areas where food equipment and single-service articles are stored.

(5) Immediately following an inspection, servicing, or maintenance of a grease interceptor located inside a retail food establishment, the grease interceptor and the surrounding area shall be cleaned and sanitized.

~~5-402.13 Conveying Sewage.~~ **5-402.13 Conveying Sewage.**

Sewage shall be conveyed to the point of disposal through an approved sanitary sewage system or other system, including use of sewage transport vehicles, waste retention tanks, pumps, pipes, hoses, and connections that are constructed, maintained, and operated according to law.<sup>P</sup>

~~5-402.14 Removing Mobile Food Establishment Wastes.~~ **5-402.14 Removing Mobile Food Establishment Wastes.**

Sewage and other liquid wastes shall be removed from a mobile food establishment at an approved waste servicing area or by a sewage transport vehicle in such a way that a public health hazard or nuisance is not created or that sewage is not discharged to the environment.<sup>Pf</sup>

~~5-402.15 Flushing a Waste Retention Tank.~~ **5-402.15 Flushing a Waste Retention Tank.**

A tank for liquid waste retention shall be thoroughly flushed and drained in a sanitary manner during the servicing operation.

## **5-403 Disposal Facility**

### ~~5-403.11 Approved Sewage Disposal System.~~ **5-403.11 Approved Sewage Disposal System.**

Sewage shall be disposed through an approved facility that is:

(A) A public sewage treatment plant,<sup>2</sup> or

(B) An individual sewage disposal system that is sized, constructed, maintained, and operated according to law.<sup>2</sup>

### ~~5-403.12 Other Liquid Wastes and Rainwater.~~ **5-403.12 Other Liquid Wastes and Rainwater.**

Condensate drainage and other nonsewage liquids and rainwater shall be drained from the point of discharge to disposal according to law.

## **5-5 Refuse, Recyclables, and Returnables REFUSE, RECYCLABLES, AND RETURNABLES**

### **5-501 Facilities on the Premises**

#### ~~5-501.10 Indoor Storage Area.~~ **5-501.10 Indoor Storage Area.**

If located within the retail food establishment, a storage area for refuse, recyclables, and returnables shall meet the requirements specified under 6-101.11, 6-201.11 through 6-201.18, 6-202.15, and 6-202.16.

#### ~~5-501.11 Outdoor Storage Surface.~~ **5-501.11 Outdoor Storage Surface.**

An outdoor storage surface for refuse, recyclables, and returnables shall be constructed of nonabsorbent material such as concrete or asphalt and shall be smooth, durable, and sloped to drain.

#### ~~5-501.12 Outdoor Enclosure.~~ **5-501.12 Outdoor Enclosure.**

If used, an outdoor enclosure for refuse, recyclables, and returnables shall be constructed of durable and cleanable materials.

#### ~~5-501.13 Receptacles.~~ **5-501.13 Receptacles.**

(A) Except as specified in (B) of this section, receptacles and waste handling units for refuse, recyclables, and returnables, and for use with materials containing food residue shall be durable, cleanable, insect and rodent-resistant, leakproof, and nonabsorbent.

(B) Plastic bags and wet strength paper bags may be used to line receptacles for storage inside the retail food establishment, or within closed outside receptacles.

#### ~~5-501.15 Outside Receptacles.~~ **5-501.15 Outside Receptacles.**

(A) Receptacles and waste handling units for refuse, recyclables, and returnables used with materials containing food residue and used outside the retail food establishment shall be designed and constructed to have tight-fitting lids, doors, or covers.

(B) Receptacles and waste handling units for refuse and recyclables, such as an on-site compactor, shall be installed so that accumulation of debris, and insect and rodent attraction, and harborage are minimized and effective cleaning is facilitated around and, if the unit is not installed flush with the base pad, under the unit.

~~5-501.16 Storage Areas, Rooms, and Receptacles, Capacity and Availability.~~ **5-501.16 Storage Areas, Rooms, and Receptacles, Capacity and Availability.**

(A) An inside storage room and area, and outside storage area and enclosure, and receptacles shall be of sufficient capacity to hold refuse, recyclables, and returnables that accumulate.

(B) A receptacle shall be provided in each area of the retail food establishment or premises where refuse is generated or commonly discarded, or where recyclables or returnables are placed.

(C) If disposable towels are used at handwashing lavatories, a waste receptacle shall be located at each lavatory or group of adjacent lavatories.

~~5-501.17 Toilet Room Receptacle, Covered.~~ **5-501.17 Toilet Room Receptacle, Covered.**

A toilet room used by females shall be provided with a covered receptacle for sanitary napkins.

~~5-501.18 Cleaning Implements and Supplies.~~ **5-501.18 Cleaning Implements and Supplies.**

(A) Except as specified in (B) of this section, suitable cleaning implements and supplies, such as high pressure pumps, hot water, steam, and detergent, shall be provided as necessary for effective cleaning of receptacles and waste handling units for refuse, recyclables, and returnables.

(B) If approved, off-premises-based cleaning services may be used if on-premises cleaning implements and supplies are not provided.

~~5-501.19 Storage Areas, Redeeming Machines, Receptacles, and Waste Handling Units, Location.~~ **5-501.19 Storage Areas, Redeeming Machines, Receptacles, and Waste Handling Units, Location.**

(A) An area designated for refuse, recyclables, returnables, and, except as specified in (B) of this section, a redeeming machine for recyclables or returnables shall be located so that it is separate from food, equipment, utensils, linens, and single-service and single-use articles and a public health hazard or nuisance is not created.

(B) A redeeming machine may be located in the packaged food storage area or consumer area of a retail food establishment if food, equipment, utensils, linens, and single-service and single-use articles are not subject to contamination from the machines and a public health hazard or nuisance is not created.

(C) The location of receptacles and waste handling units for refuse, recyclables, and returnables may not create a public health hazard or nuisance or interfere with the cleaning of adjacent space.

~~5-501.110 Storing Refuse, Recyclables, and Returnables.~~ **5-501.110 Storing Refuse, Recyclables, and Returnables.**

Refuse, recyclables, and returnables shall be stored in receptacles or waste handling units so that they are inaccessible to insects and rodents.

~~5-501.111 Areas, Enclosures, and Receptacles, Good Repair.~~ **5-501.111 Areas, Enclosures, and Receptacles, Good Repair.**

Storage areas, receptacles, and enclosures for refuse, recyclables, or returnables shall be maintained in good repair.

~~5-501.112 Outside Storage Prohibitions.~~ **5-501.112 Outside Storage Prohibitions.**

(A) Except as specified in (B) of this section, refuse receptacles not meeting the requirements specified under 5-501.13(A) such as receptacles that are not rodent-resistant, unprotected plastic bags and paper bags, or baled units that contain materials with food residue may not be stored outside.

(B) Cardboard or other packaging material that does not contain food residues and that is awaiting regularly scheduled delivery to a recycling or disposal site may be stored outside without being in a covered receptacle if it is stored so that it does not create a rodent harborage problem.

~~5-501.113 Covering Receptacles.~~ **5-501.113 Covering Receptacles.**

Receptacles and waste handling units for refuse, recyclables, and returnables shall be kept covered:

(A) Inside the retail food establishment if the receptacles and units:

- (1) Contain food residue and are not in continuous use; or
- (2) After they are filled; and

(B) With tight-fitting lids or doors if kept outside the retail food establishment.

~~5-501.114 Using Drain Plugs.~~ **5-501.114 Using Drain Plugs.**

Drains in receptacles and waste handling units for refuse, recyclables, and returnables shall have drain plugs in place.

~~5-501.115 Maintaining Refuse Areas and Enclosures.~~ **5-501.115 Maintaining Refuse Areas and Enclosures.**

A storage area and enclosure for refuse, recyclables, or returnables shall be maintained free of unnecessary items, as specified under 6-501.114, and clean.

~~5-501.116 Cleaning Receptacles.~~ **5-501.116 Cleaning Receptacles.**

(A) Receptacles and waste handling units for refuse, recyclables, and returnables shall be thoroughly cleaned in a way that does not contaminate food, equipment, utensils, linens, or single-service and single-use articles, and waste water shall be disposed of as specified under 5-402.13.

(B) Soiled receptacles and waste handling units for refuse, recyclables, and returnables shall be cleaned at a frequency necessary to prevent them from developing a buildup of soil or becoming attractants for insects and rodents.

## **5-502 Removal**

### ~~5-502.11 Frequency.~~ **5-502.1 Frequency.**

Refuse, recyclables, and returnables shall be removed from the premises at a frequency that will minimize the development of objectionable odors and other conditions that attract or harbor insects and rodents.

### ~~5-502.12 Receptacles or Vehicles.~~ **5-502.12 Receptacles or Vehicles.**

Refuse, recyclables, and returnables shall be removed from the premises by way of:

- (A) Portable receptacles that are constructed and maintained according to law; or
- (B) A transport vehicle that is constructed, maintained, and operated according to law.

## **5-503 Facilities for Disposal and Recycling**

### ~~5-503.11 Community or Individual Facility.~~ **5-503.11 Community or Individual Facility.**

Solid waste not disposed of through the sewage system such as through grinders and pulpers shall be recycled or disposed of in an approved public or private community recycling or refuse facility; or solid waste shall be disposed of in an individual refuse facility, such as a landfill or incinerator, which is sized, constructed, maintained, and operated according to law.

## **Chapter 6 Physical Facilities**

### ~~6-1 Materials for Construction and Repair~~ **MATERIALS FOR CONSTRUCTION AND REPAIR**

#### ~~6-101 Indoor Areas~~ **6-101 Indoor Areas**

##### ~~6-101.11 Surface Characteristics.~~ **6-101.1 Surface Characteristics.**

Materials for indoor floor, wall, and ceilings surfaces under conditions of normal use shall be:

(A) Smooth, durable, and easily cleanable for areas where retail food establishment operations are conducted;

(B) Closely woven and easily cleanable carpet for carpeted areas; and

(C) Nonabsorbent for areas subject to moisture such as food preparation areas, walk-in refrigerators, warewashing areas, toilet rooms, mobile food establishment servicing areas, and areas subject to flushing or spray cleaning methods.

#### ~~6-102 Outdoor Areas~~ **OUTDOOR AREAS**

##### ~~6-102.11 Surface Characteristics.~~ **6-102.1 Surface Characteristics.**



(A) The outdoor walking and driving areas shall be surfaced with concrete, asphalt, or gravel, or other materials that have been effectively treated to minimize dust, facilitate maintenance, and prevent muddy conditions.

(B) Exterior surfaces of buildings and mobile food establishments shall be of weather-resistant materials and shall comply with law.

(C) Outdoor storage areas for refuse, recyclables, or returnables shall be of materials specified under 5-501.11 and 5-501.12.

## **~~6-2 Design, Construction, and Installation~~ DESIGN, CONSTRUCTION, AND INSTALLATION**

### **~~6-201 Cleanability~~**

#### ~~6-201.11 Floors, Walls, and Ceilings.~~ **6-201.1 Floors, Walls, and Ceilings.**

Except as specified under 6-201.14 and except for antislip floor coverings or applications that may be used for safety reasons, floors, floor coverings, walls, wall coverings, and ceilings shall be designed, constructed, and installed so they are smooth and easily cleanable.

#### ~~6-201.12 Floors, Walls, and Ceilings, Utility Lines.~~ **6-201.12 Floors, Walls, and Ceilings, Utility Lines.**

(A) Utility service lines and pipes may not be unnecessarily exposed.

(B) Exposed utility service lines and pipes shall be installed so they do not obstruct or prevent cleaning of the floors, walls, or ceilings.

(C) Exposed horizontal utility service lines and pipes may not be installed on the floor.

#### ~~6-201.13 Floor and Wall Junctions, Coved and Enclosed or Sealed.~~ **6-201.13 Floor and Wall Junctions, Coved and Enclosed or Sealed.**

(A) In retail food establishments in which cleaning methods other than water flushing are used for cleaning floors, the floor and wall junctions shall be coved and closed to no larger than one (1) thirty-second inch (1 mm).

(B) The floors in retail food establishments in which water flush cleaning methods are used shall be provided with drains and be graded to drain, and ~~and~~ The floor and wall junctions shall be coved and sealed.

#### ~~6-201.14 Floor Carpeting, Restrictions and Installation.~~ **6-201.14 Floor Carpeting, Restrictions and Installation.**

(A) A floor covering such as carpeting or similar material may not be installed as a floor covering in food preparation areas, walk-in refrigerators, warewashing areas, toilet room areas where handwashing lavatories, toilets, and urinals are located, refuse storage rooms, or other areas where the floor is subject to moisture, flushing, or spray cleaning methods.

(B) If carpeting is installed as a floor covering in areas other than those specified under (A) of this section, it shall be:

(1) Securely attached to the floor with a durable mastic, by using a stretch and tack method, or by another method; and

(2) Installed tightly against the wall under the coving or installed away from the wall with a space between the carpet and the wall and with the edges of the carpet secured by metal stripping or some other means.

~~6-201.15 Floor Covering, Mats and Duckboards.~~ **6-201.15 Floor Covering, Mats and Duckboards.**

Mats and duckboards shall be designed to be removable and easily cleanable.

~~6-201.16 Wall and Ceiling Coverings and Coatings.~~ **6-201.16 Wall and Ceiling Coverings and Coatings.**

(A) Wall and ceiling covering materials shall be attached so that they are easily cleanable.

(B) Except in areas used only for dry storage, concrete, porous blocks, or bricks used for indoor wall construction shall be finished and sealed to provide a smooth, nonabsorbent, easily cleanable surface.

~~6-201.17 Wall and Ceiling Attachments.~~ **6-201.17 Wall and Ceiling, Attachments.**

(A) Except as specified in (B) of this section, attachments to walls and ceilings such as light fixtures, mechanical room ventilation system components, vent covers, wall mounted fans, decorative items, and other attachments shall be easily cleanable.

(B) In a consumer area, wall and ceiling surfaces and decorative items and attachments that are provided for ambiance need not meet this requirement if they are kept clean.

~~6-201.18 Walls and Ceiling, Studs, Joists, and Rafters.~~ **6-201.18 Walls and Ceiling, Studs, Joists, and Rafters.**

Except for temporary food establishments, studs, joists, and rafters may not be exposed in areas subject to moisture.

## **6-202 Functionality**

~~6-202.11 Light Bulbs, Protective Shielding.~~ **6-202.11 Light Bulbs, Protective Shielding.**

(A) Except as specified in (B) of this section, light bulbs shall be shielded, coated, or otherwise shatter-resistant in areas where there is exposed food, clean equipment, utensils and linens, or unwrapped single-service and single-use articles.

(B) Shielded, coated, or otherwise shatter-resistant bulbs need not be used in areas used only for storing food in unopened packages, if:

(1) The integrity of the packages cannot be affected by broken glass falling onto them; and

(2) The packages are capable of being cleaned of debris from broken bulbs before the packages are opened.

(C) An infrared or other heat lamp shall be protected against breakage by a shield surrounding and extending beyond the bulb so that only the face of the bulb is exposed.

~~6-202.12 Heating, Ventilating, Air-conditioning System Vents.~~ **6-202.12 Heating, Ventilating, Air-conditioning System Vents.**

Heating, ventilating, and air conditioning systems shall be designed and installed so that make-up air intake and exhaust vents do not cause contamination of food, food-contact surfaces, equipment, or utensils.

~~6-202.13 Insect Control Devices, Design and Installation.~~ **6-202.13 Insect Control Devices, Design, and Installation.**

(A) Insect control devices that are used to electrocute or stun flying insects shall be designed to retain the insect within the device.

(B) Insect control devices shall be installed so that:

(1) The devices are not located over a food preparation area; and

(2) Dead insects and insect fragments are prevented from being impelled onto or falling on exposed food, clean equipment, utensils, and linens, and unwrapped single-service and single-use articles.

~~6-202.14 Toilet Rooms, Enclosed.~~ **6-202.14 Toilet Rooms, Enclosed.**

Except where a toilet room is located outside a retail food establishment and does not open directly into the retail food establishment such as a toilet room that is provided by the management of a shopping mall, a toilet room located on the premises shall be completely enclosed and provided with a tight-fitting and self-closing door for a public access restroom, an alcove opening as approved by local building codes.

~~6-202.15 Outer Openings Protected.~~ **6-202.15 Outer Openings Protected.**

(A) Except as specified in (B), (C), ~~and (E)~~, and under (D) of this section, outer openings of a retail food establishment shall be protected against the entry of insects and rodents by:

(1) Filling or closing the holes and other gaps along floors, walls, and ceiling;

(2) Closed tight-fitting windows; and

(3) Solid, self-closing, tight-fitting doors.

(B) Paragraph (A) of this section does not apply if a retail food establishment opens into a larger structure, such as a mall, airport, or office building, or into an attached structure, such as a porch, and the outer openings from the larger or attached structure are protected against the entry of insects and rodents.

(C) Exterior doors used as exits need not be self-closing if they are:

(1) Solid and tight-fitting;

(2) Designated for use, only when an emergency exists, by the fire protection authority that has jurisdiction over the retail food establishment; and

(3) Limited-use so they are not used for entrance or exit from the building for purposes other than the designated emergency exit use.

(D) Except as specified in (B) and (E) of this section, if the windows or doors of a retail food establishment, or of a larger structure within which a retail food establishment is located, are kept open for ventilation or other purposes ~~or a temporary food establishment is not provided with windows and doors as specified under (A) of this section,~~ the openings shall be protected against the entry of insects and rodents by:

- (1) Sixteen (16) mesh to one (1) inch (16 mesh to 25.4 mm) screens;
- (2) Properly designed and installed air curtains to control flying insects; or
- (3) Other effective means.

(E) Paragraph (D) of this section does not apply if flying insects and other pests are absent due to the location of the establishment, the weather, or other limiting conditions.

~~6-202.16 Exterior Walls and Roofs, Protective Barrier.~~ **6-202.16 Exterior Walls and Roofs, Protective Barrier.**

Perimeter walls and roofs shall effectively protect the retail food establishment from the weather and the entry of insects, rodents, and other animals.

~~6-202.18 Outdoor Servicing Areas, Overhead Protection.~~ **6-202.18 Outdoor Servicing Areas, Overhead Protection.**

Except for areas used only for the loading of water or the discharge of sewage and other liquid waste, through the use of a closed system of hoses, servicing areas shall be provided with overhead protection.

~~6-202.19 Outdoor Walking and Driving Surfaces, Graded to Drain.~~ **6-202.19 Outdoor Walking and Driving Surfaces, Graded to Drain.**

Exterior walking and driving surfaces shall be graded to drain.

~~6-202.110 Outdoor Refuse Areas, Curbed and Graded to Drain.~~ **6-202.110 Outdoor Refuse Areas, Curbed and Graded to Drain.**

Outdoor refuse areas shall be constructed in accordance with law and shall be curbed and graded to drain to collect and dispose of liquid waste that results from the refuse and from cleaning the area and waste receptacles.

~~6-202.111 Private Residence and Living or Sleeping Quarters, Use Prohibition.~~ **6-202.111 Private Residence and Living or Sleeping Quarters, Use Prohibition.**

A private home, a room used as living or sleeping quarters, or an area directly opening into a room used as living or sleeping quarters may not be used for conducting retail food establishments operations<sup>P</sup>

~~6-202.112 Living or Sleeping Quarters, Separation.~~ **6-202.112 Living or Sleeping Quarters, Separation.**

Living or sleeping quarters located in the premises of a retail food establishment, such as those provided for lodging registration clerks or resident managers, shall be separated from rooms and areas used for retail food establishment operations by complete partitioning and solid self-closing doors.

~~6-3 Numbers and Capacities~~ **NUMBERS AND CAPACITIES**

~~6-301 Handwashing Sinks~~

~~6-301.10 Minimum Number.~~ **6-301.10 Minimum Number.**

Handwashing sinks shall be provided as specified under 5-203.11.

~~6-301.11 Handwashing Cleanser, Availability.~~ **6-301.11 Handwashing Cleanser, Availability.**

Each handwashing sink or group of two (2) adjacent handwashing sinks shall be provided with a supply of hand cleaning; liquid, powder, or bar soap.<sup>pf</sup>

~~6-301.12 Hand Drying Provision.~~ **6-301.12 Hand Drying Provision.**

Each handwashing sink or group of adjacent handwashing sinks shall be provided with:

- (A) Individual disposable towels;<sup>pf</sup> or
- (B) A continuous towel system that supplies the user with a clean towel;<sup>pf</sup> or
- (C) A heated-air hand drying device;<sup>pf</sup> or
- (D) A hand-drying device that employs an air-knife system that delivers high velocity, pressurized air at ambient temperatures.<sup>pf</sup>

~~6-301.13 Handwashing Aids and Devices, Use Restrictions.~~ **6-301.13 Handwashing Aids and Devices, Use Restrictions.**

A sink used for food preparation or utensil washing, or a service sink, or curbed cleaning facility used for the disposal of mop water or similar wastes; may not be provided with the handwashing aids and devices required for a handwashing sink as specified under 5-501.16(C), 6-301.11 and 6-301.12.

~~6-301.14 Handwashing Signage.~~ **6-301.14 Handwashing Signage.**

A sign or poster that notifies food employees to wash their hands shall be provided at all handwashing sinks used by food employees and shall be clearly visible to food employees.

~~6-301.20 Disposable Towels, Waste Receptacle.~~ **6-301.20 Disposable Towels, Waste Receptacle.**

A handwashing sink or group of adjacent handwashing sinks that is provided with disposable towels shall be provided with a waste receptacle as specified under 5-501.16(C).

**6-302 Toilets and Urinals**

~~6-302.10 Minimum Number.~~ **6-302.10 Minimum Number.**

Toilets and urinals shall be provided as specified under 5-203.12.

~~6-302.11 Toilet Tissue, Availability.~~ **6-302.11 Toilet Tissue, Availability**

A supply of toilet tissue shall be available at each toilet.<sup>pf</sup>

**6-303 Lighting**

~~6-303.11 Intensity.~~ **6-303.11 Intensity.**

The light intensity shall be:

(A) At least ten (10) foot-candles (108 lux) at a distance of thirty (30) inches (75cm) above the floor, in walk-in refrigeration units and dry storage areas, and in other areas and rooms during periods of cleaning;

(B) At least twenty (20) foot-candles (215 lux):

(1) At a surface where food is provided for customer self-service such as buffets and salad bars or where fresh produce or packaged foods are sold or offered for consumption;

(2) Inside equipment such as reach-in and under-counter refrigerators; and

(3) At a distance of thirty (30) inches (75cm) above the floor in areas used for handwashing, warewashing, and equipment and utensil storage, and in toilet rooms; and

(C) At least fifty (50) foot-candles (540 lux) at a surface where a food employee is working with food or working with utensils or equipment such as knives, slicers, grinders, and saws where employee safety is a factor.

**6-304 Ventilation**

~~6-304.11 Mechanical.~~ **6-304.11 Mechanical.**

If necessary to keep rooms free of excessive heat, steam, condensation, vapors, obnoxious odors, smoke, and fumes, mechanical ventilation of sufficient capacity shall be provided.

**6-305 Dressings Areas and Lockers**

~~6-305.11 Designation.~~ **6-305.11 Designation.**

(A) Dressing rooms or dressing areas shall be designated if employees routinely change their clothes in the establishment.

(B) Lockers or other suitable facilities shall be provided for the orderly storage of employees' clothing and other possessions.

**6-306 Service Sinks**

~~6-306.10 Availability.~~ **6-306.10 Availability.**

A service sink or curbed cleaning facility shall be provided as specified in 5-203.13(A).

**6-4 Location and Placement** LOCATION AND PLACEMENT

**6-401 Handwashing Sinks**

~~6-401.10 Conveniently Located.~~ **6-401.10 Conveniently Located.**

Handwashing sinks shall be conveniently located as specified in 5-204.11.

**6-402 Toilet Rooms**

~~6-402.11 Convenience and Accessibility.~~ **6-402.11 Convenience and Accessibility.**

Toilet rooms shall be conveniently located and shall be accessible to employees during all hours of operation.

**6-403 Employee Accommodations**

~~6-403.11 Designated Areas.~~ **6-403.1 Designated Areas.**

(A) Areas designated for employees to eat, drink, and use tobacco shall be located so that food, equipment, linens, and single-service and single-use articles are protected from contamination.

(B) Lockers or other suitable facilities shall be located in a designated room or area where contamination of food, equipment, utensils, linens, and single-service and single-use articles can not occur.

**6-404 Distressed Merchandise**

~~6-404.11 Segregation and Location.~~ **6-404.1 Segregation and Location.**

Products that are held by the permit holder for credit, redemption, or return to the distributor, such as damaged, spoiled, or recalled products, shall be segregated and held in designated areas that are separated from food, equipment, utensils, linens, and single-service and single-use articles.<sup>pf</sup>

**6-405 Refuse, Recyclables, and Returnables**

~~6-405.10 Receptacles, Waste Handling Units, and Designated Storage Areas.~~ **6-405.10 Receptacles, Waste Handling Units, and Designated Storage Areas.**

Units, receptacles, and areas designated for storage of refuse and recyclable and returnable containers shall be located as specified under 5-501.19.

**6-5 Maintenance and Operation** MAINTENANCE AND OPERATION

**6-501 Premises, Structures, Attachments, and Fixtures - Methods**

~~6-501.11 Repairing.~~ **6-501.11 Repairing.**

Physical facilities shall be maintained in good repair.

~~6-501.12 Cleaning, Frequency and Restrictions.~~ **6-501.12 Cleaning, Frequency and Restrictions.**

(A) Physical facilities shall be cleaned as often as necessary to keep them clean.

(B) Except for cleaning that is necessary due to a spill or other accident, cleaning shall be done during periods when the least amount of food is exposed, such as after closing.

~~6-501.13 Cleaning Floors, Dustless Methods.~~ **6-501.13 Cleaning Floors, Dustless Methods.**

(A) Except as specified in (B) of this section, only dustless methods of cleaning shall be used, such as wet cleaning, vacuum cleaning, mopping with treated dust mops, or sweeping using a broom and dust-arresting compounds.

(B) Spills or drippage on floors that occur between normal floor cleaning times may be cleaned:

(1) Without the use of dust-arresting compounds; and

(2) In the case of liquid spills or drippage, with the use of a small amount of absorbent compound such as sawdust or diatomaceous earth applied immediately before spot cleaning.

~~6-501.14 Cleaning Ventilation Systems, Nuisance and Discharge Prohibition.~~ **6-501.14 Cleaning Ventilation Systems, Nuisance and Discharge Prohibition.**

(A) Intake and exhaust air ducts shall be cleaned and filters changed so they are not a source of contamination by dust, dirt, and other materials.

(B) If vented to the outside, ventilation systems may not create a public health hazard, or nuisance or unlawful discharge.

~~6-501.15 Cleaning Maintenance Tools, Preventing Contamination.~~ **6-501.15 Cleaning Maintenance Tools, Preventing Contamination.**

Food preparation sinks, handwashing sinks, and warewashing equipment may not be used for the cleaning of maintenance tools, the preparation or holding of maintenance materials, or the disposal of mop water and similar liquid wastes.<sup>pf</sup>

~~6-501.16 Drying Mops.~~ **6-501.16 Drying Mops.**

After use, mops shall be placed in a position that allows them to air-dry without soiling walls, equipment, or supplies.

~~6-501.17 Absorbent Material on Floors, Use Limitation.~~ **6-501.17 Absorbent Material on Floors, Use Limitation.**

Except as specified in 6-501.13(B), sawdust, wood shavings, granular salt, baked clay, diatomaceous earth, or similar materials may not be used on floors.

~~6-501.18 Cleaning of Plumbing Fixtures.~~ **6-501.18 Cleaning of Plumbing Fixtures.**



Plumbing fixtures such as handwashing sinks, toilets, and urinals shall be cleaned as often as necessary to keep them clean.

~~6-501.19 Closing Toilet Room Doors.~~ **6-501.10 Closing Toilet Room Doors.**

Except during cleaning and maintenance operations, toilet room doors as specified under 6-202.14 shall be kept closed.

~~6-501.110 Using Dressing Rooms and Lockers.~~ **6-501.110 Using Dressing Rooms and Lockers.**

(A) Dressing rooms shall be used by employees if the employees regularly change their clothes in the establishment.

(B) Lockers or other suitable facilities shall be used for the orderly storage of employee clothing and other possessions.

~~6-501.111 Controlling Pests.~~ **6-501.111 Controlling Pests.**

The premises shall be maintained free of insects, rodents, and other pests. The presence of insects, rodents, and other pests shall be controlled to eliminate their presence on the premises by:

(A) Routinely inspecting incoming shipments of food and supplies;

(B) Routinely inspecting the premises for evidence of pests;

(C) Using methods, if pests are found, such as trapping devices or other means of pest control as specified under 7-202.12, 7-206.12, and 7-206.13;<sup>pf</sup> and

(D) Eliminating harborage conditions.

~~6-501.112 Removing Dead or Trapped Birds, Insects, Rodents, and Other Pests.~~ **6-501.112 Removing Dead or Trapped Birds, Insects, Rodents, and Other Pests.**

Dead or trapped birds, insects, rodents, and other pests shall be removed from control devices and the premises at a frequency that prevents their accumulation, decomposition, or the attraction of pests.

~~6-501.113 Storing Maintenance Tools.~~ **6-501.113 Storing Maintenance Tools.**

Maintenance tools such as brooms, mops, vacuum cleaners, and similar items shall be:

(A) Stored so they do not contaminate food, equipment, utensils, linens, and single-service and single-use articles; and

(B) Stored in an orderly manner that facilitates cleaning the area used for storing the maintenance tools.

~~6-501.114 Maintaining Premises, Unnecessary Items, and Litter.~~ **6-501.114 Maintaining Premises, Unnecessary Items, and Litter.**

The premises shall be free of:

(A) Items that are unnecessary to the operation or maintenance of the establishment such as equipment that is nonfunctional or no longer used; and

(B) Litter.

~~6-501.115 Prohibiting Animals.~~ **6-501.115 Prohibiting Animals.**

(A) Except as specified in (B) and (C) of this section, live animals may not be allowed on the premises of a retail food establishment.<sup>2f</sup>

(B) Live animals may be allowed in the following situations if the contamination of food~~;~~, clean equipment, utensils, ~~and~~ linens~~;~~, and unwrapped single-service and single-use articles can not result:

(1) Edible fish or decorative fish in aquariums, shellfish or crustacea on ice or under refrigeration, and shellfish and crustacea in display tank systems;

(2) Patrol dogs accompanying police or security officers in offices ~~and~~ dining, sales, and storage areas, and sentry dogs running loose in outside fenced areas;

(3) In areas that are not used for food preparation and that are usually open for customers, such as dining and sales areas, service animals as defined by the *Americans with Disabilities Act* controlled by the disabled employee or person, if a health or safety hazard will not result from the presence or activities of the service animal;

(4) Pets in the common dining areas of institutional care facilities such as nursing homes, assisted living facilities, group homes, or residential care facilities at times other than during meals if:

(a) Effective partitioning and self-closing doors separate the common dining areas from food storage or food preparation areas,

(b) Condiments, equipment, and utensils are stored in enclosed cabinets or removed from the common dining areas when pets are present, and

(c) Dining areas including tables, countertops, and similar surfaces are effectively cleaned before the next meal service; and

(5) In areas that are not used for food preparation, storage, sales, display, or dining, in which there are caged animals or animals that are similarly confined, such as in a variety store that sells pets or a tourist park that displays animals.

(C) Live or dead fish bait may be stored if contamination of food~~;~~, clean equipment, utensils, and—linens~~;~~, and unwrapped single-service and single-use articles cannot result.

## **Chapter ~~Poisonous or Toxic Materials~~**

### **7-1 ~~Labeling and Identification~~ LABELING AND IDENTIFICATION**

#### **7-101 ~~Original Containers~~**

##### ~~7-101.11 Identifying Information, Prominence.~~ **7-101.11 Identifying Information, Prominence.**

Containers of poisonous or toxic materials and personal care items shall bear a legible manufacturer's label.<sup>Pf</sup>

## **7-102~~Working Containers~~**

### ~~7-102.11 Common Name.~~ **7-102.1~~Common Name.~~**

Working containers used for storing poisonous or toxic materials such as cleaners and sanitizers taken from bulk supplies shall be clearly and individually identified with the common name of the material.<sup>Pf</sup>

## **7-2~~Operational Supplies and Application~~ OPERATIONAL SUPPLIES AND APPLICATION**

### **7-201~~Storage~~**

#### ~~7-201.11 Separation.~~ **7-201.1~~Separation.~~**

Poisonous or toxic materials shall be stored so that they cannot contaminate food, equipment, utensils, linens, and single-service and -single-use- articles by:

(A) Separating the poisonous or toxic materials by spacing or partitioning<sup>P</sup> and

(B) Locating the poisonous or toxic materials in an area that is not above food, equipment, utensils, linens, and single-service and -single-use- articles. This paragraph does not apply to equipment and utensil cleaners and sanitizers that are stored in warewashing areas for availability and convenience if the materials are stored to prevent contamination of food, equipment, utensils, linens, and single-service and single-use articles <sup>P</sup>

### **7-202~~Presence and Use~~**

#### ~~7-202.11 Restriction.~~ **7-202.1~~Restriction.~~**

(A) Only those poisonous or toxic materials that are required for operation and maintenance of the retail food establishment, such as for the cleaning and sanitizing of equipment and utensils and the control of insects and rodents, shall be allowed in a retail food establishment.<sup>Pf</sup>

(B) This requirement does not apply to packaged poisonous or toxic materials and medicines that are offered for retail sale.

#### ~~7-202.12 Conditions of Use.~~ **7-202.1~~Conditions of Use.~~**

Poisonous or toxic materials, shall be:

(A) Used according to:

(1) Law and this regulation, and

(2) Manufacturer's use directions included in labeling, and, for a pesticide, manufacturer's label instructions that state that use is allowed in a retail food establishment, and<sup>P</sup>

(3) The conditions of certification, if certification is required, for use of the pest control materials, <sup>P</sup> and

(4) Additional conditions that may be established by the Department; and

(B) Applied so that:

(1) A hazard to employees or other persons is not constituted,<sup>2</sup> and

(2) Contamination including toxic residues due to drip, drain, fog, splash, or spray on food, equipment, utensils, linens, and single-service and single-use articles is prevented by and for a restricted use pesticide; this is achieved by:<sup>2</sup>

(a) Removing the items,<sup>2</sup>

(b) Covering the items with impermeable covers,<sup>2</sup> or

(c) Taking other appropriate preventive actions,<sup>2</sup> and

(d) Cleaning and sanitizing equipment and utensils, after the application.<sup>2</sup>

(C) A restricted use pesticide shall be applied only by an applicator certified as defined in 7 USC 136, *Definition (e) Certified Applicator, of the Federal Insecticide, Fungicide, and Rodenticide Act* person under the direct supervision of a certified applicator.<sup>2f</sup>

### **7-203 Container Prohibitions**

~~7-203.11 Chemical, Poisonous, or Toxic Material Containers.~~ **7-203.11 Chemical, Poisonous, or Toxic Material Containers.**

A container previously used to store chemicals, including poisonous or toxic materials, may not be used to store, transport, or dispense food.<sup>2</sup>

### **7-204 Chemicals**

~~7-204.11 Sanitizers, Criteria.~~ **7-204.11 Sanitizers, Criteria.**

Chemical sanitizers, including chemical sanitizing solutions generated on-site, and other chemical antimicrobials applied to food-contact surfaces shall:

(A) Meet the requirements specified in 40 CFR 180.940, *Tolerance Exemptions For Active And Inert Ingredients For Use in Antimicrobial Formulations (Food-Contact Surface Sanitizing Solutions)* or

(B) Meet the requirements as specified in 40 CFR 180.2020, *Pesticide Chemicals Not Requiring A Tolerance Or Exemption From Tolerance-Non-Food Determinations.*

~~7-204.12 Chemicals for Washing, Treatment, Storage, and Processing Fruits and Vegetables.~~ **7-204.12 Chemicals for Washing, Treatment, Storage, and Processing Fruits and Vegetables.**

~~(A) Chemicals, including those generated on-site, used to wash or peel raw, whole fruits and vegetables or used in the treatment, storage, and processing of fruits and vegetables shall:~~

(1A) Be an approved food additive listed for this intended use in 21 CFR 173.368, or

(2B) Be generally recognized as safe (GRAS) for this intended use, or

(3C) Be the subject of an effective food contact notification for this intended use (only effective for the manufacturer or supplier identified in the notification), and

(4D) Meet the requirements in 40 CFR 156 *Labeling Requirements for Pesticide and Devices*

~~(B) Ozone as an antimicrobial agent used in the treatment, storage, and processing of fruits and vegetables in a retail food establishment shall meet the requirements specified in 21 CFR 173.368, Ozone~~

~~7-204.13 Boiler Water Additives, Criteria.~~ **7-204.13 Boiler Water Additives, Criteria.**

Chemicals used as boiler water additives shall meet the requirements specified in 21 CFR 173.310, *Boiler Water Additives*

~~7-204.14 Drying Agents Criteria.~~ **7-204.14 Drying Agents Criteria.**

Drying agents used in conjunction with sanitization shall:

(A) Contain only components that are listed as one of the following:

(1) Generally recognized as safe for use in food as specified in 21 CFR 182, *Substances Generally Recognized as Safe*, or 21 CFR 184, *Direct Food Substances Affirmed as Generally Recognized as Safe*

(2) Generally recognized as safe for the intended use as specified in 21 CFR 186, *Indirect Food Substances Affirmed as Generally Recognized as Safe*

(3) Generally recognized as safe for the intended use as determined by experts qualified in scientific training and experience to evaluate the safety of substances added, directly or indirectly, to food as described in 21 CFR 170.30, *Eligibility for Classification as Generally Recognized as Safe (GRAS)*, or

(4) Subject of an effective *Food Contact Notification* described in the *Federal Food Drug and Cosmetic Act (FFDCA)* section 409(h); or

(5) Approved for use as a drying agent under a prior sanction as described in the *Federal Food Drug and Cosmetic Act (FFDCA)* (4); or

(6) Specifically regulated as an indirect food additive for use as a drying agent as specified in 21 CFR Parts 174 through 178; or

(7) Approved for use as a drying agent under the threshold of regulation process established by 21 CFR 170.39, *Threshold of regulation for substances used in food-contact articles*

(B) When sanitization is with chemicals, the approval required under (A)(5) or (A)(7) of this section or the regulation as an indirect food additive required under (A)(6) of this section, shall be specifically for use with chemical sanitizing solutions.

## **7-205 Lubricants**

~~7-205.11 Incidental Food Contact, Criteria.~~ **7-205.11 Incidental Food Contact, Criteria.**

Lubricants shall meet the requirements specified in 21 CFR 178.3570, *Lubricants ~~W~~with Incidental Food Contact*, if they are used on food contact surfaces, on bearings and gears located on or within food contact surfaces, or on bearings and gears that are located so that lubricants may leak, drip, or be forced into food or onto food contact surfaces. <sup>p</sup>

**7-206 Pesticides**

~~7-206.11 Restricted Use Pesticides, Criteria.~~ **7-206.11 Restricted Use Pesticides, Criteria.**

Restricted use pesticides specified in 7-202.12(C) shall meet the requirements specified in 40 CFR 152, Subpart I, *Classification of Pesticides*

~~7-206.12 Rodent Bait Stations.~~ **7-206.12 Rodent Bait Stations.**

Rodent bait shall be contained in a covered, tamper-resistant bait station. <sup>p</sup>

~~7-206.13 Tracking Powders, Pest Control, and Monitoring.~~ **7-206.13 Tracking Powders, Pest Control, and Monitoring.**

(A) Except as specified in (B) of this section, a tracking powder may not be used in retail food establishments. <sup>p</sup>

(B) If used, a nontoxic tracking powder, such as talcum or flour, may not contaminate food, equipment, utensils, linens, and ~~single-service~~ single-service and single-use articles.

**7-207 Medicines**

~~7-207.11 Restriction and Storage.~~ **7-207.11 Restriction and Storage.**

(A) Except for medicines that are stored or displayed for retail sale, only those medicines that are necessary for the health of employees shall be allowed in a retail food establishment. <sup>pf</sup>

(B) Medicines that are in a retail food establishment for the employees' use shall be labeled as specified under 7-101.11 and located to prevent the contamination of food, equipment, utensils, linens, and single-service and single-use articles. <sup>p</sup>

~~7-207.12 Refrigerated Medicines, Storage.~~ **7-207.12 Refrigerated Medicines, Storage.**

Medicines belonging to employees or to children in a day care center that require refrigeration and are stored in a food refrigerator shall be:

(A) Stored in a package or container and kept inside a covered, leakproof container that is identified as a container for the storage of medicines; <sup>p</sup> and

(B) Located so they are inaccessible to children. <sup>p</sup>

**7-208 First Aid Supplies**

~~7-208.11 Storage.~~ **7-208.1 Storage.**

First aid supplies that are in a retail food establishment for the employees' use shall be:

(A) Labeled as specified under 7-101.11<sup>Pf</sup> and

(B) Stored in a kit or a container that is located to prevent the contamination of food, equipment, utensils, linens, and ~~single-service~~single-service and single-use articles.<sup>P</sup>

**~~7-209~~Other Personal Care Items**

~~7-209.11 Storage.~~ **7-209.1 Storage.**

Except as specified under 7-207.12 and 7-208.11, employees shall store their personal care items in facilities as specified under 6-305.11(B).

**~~7-3 Stock And Retail Sale~~STOCK AND RETAIL SALE**

**~~7-301~~Storage and Display**

~~7-301.11 Separation.~~ **7-301.1 Separation.**

Poisonous or toxic materials shall be stored and displayed for retail sale so they cannot contaminate food, equipment, utensils, linens, and single-service and single-use articles by:

(A) Separating the poisonous or toxic materials by spacing or partitioning;<sup>P</sup> and

(B) Locating the poisonous or toxic materials in an area that is not above food, equipment, utensils, linens, and single-service or single-use articles.<sup>P</sup>

**~~Chapter 8~~Compliance and Enforcement**

**~~8-1~~REGULATION APPLICABILITY**

**~~8-101~~Use for Intended Purpose**

~~8-101.10 Public Health Protection.~~ **8-101.10 Public Health Protection.**

Retail food establishments in operation prior to the effective date of this regulation and in compliance with the previous regulation, but which do not fully comply with all the construction, equipment, and physical requirements of this regulation, shall be deemed acceptable provided the facilities and equipment:

(A) Are capable of being maintained in a sanitary condition; ~~and~~

(B) Are not a public health hazard or nuisance; and

(C) Are replaced in the normal course of operation with equipment and facilities that meet the requirements of this regulation.

(D) This section shall not apply to equipment installed or construction begun after the effective date of this regulation.

## **8-102 Additional Requirements**

### ~~8-102.10 Preventing Health Hazards, Provision for Conditions Not Addressed.~~ **8-102.10 Preventing Health Hazards, Provision for Conditions Not Addressed.**

(A) If necessary to protect against public health hazards or nuisances, the Department may impose specific requirements that are authorized by law in addition to the requirements contained in this regulation.

(B) The Department shall document the conditions that necessitate the imposition of additional requirements and the underlying public health rationale. The documentation shall be provided to the permit applicant or permit holder and a copy shall be maintained in the Department file for the retail food establishment.

## **8-103 Variances**

### ~~8-103.10 Modifications and Waivers.~~ **8-103.10 Modifications and Waivers.**

(A) The Department may grant a variance by modifying or waiving the requirements of this regulation if, in the opinion of the Department, a health hazard or nuisance will not result from the variance. If a variance is granted, the Department shall retain the information specified under 8-103.11 in its records for the retail food establishment.

(B) When a retail food establishment desires to use a construction procedure inconsistent with the regulation or use materials and/or equipment other than specified in this regulation, a variance may be requested from the Department. Such a request must:

- (1) Be submitted in writing, ~~and~~
- (2) Include a description of the material(s), equipment, and/or construction procedure(s) proposed, and
- (3) Identify the material, equipment and/or procedure required by the regulation, and include proof of equivalency.

(C) The Department shall only consider a complete request for approval of a variance. The Department's decision on such a variance will be final.

### ~~8-103.11 Documentation of Proposed Variance and Justification.~~ **8-103.11 Documentation of Proposed Variance and Justification.**

Before a variance from a requirement of this regulation is approved, the information provided by the retail food establishment requesting the variance and retained in the Department's file shall include:

(A) A statement of the proposed variance of this regulation requirement citing relevant regulation section(s);<sup>P</sup>

(B) An analysis of the rationale for how the potential public health hazards and nuisances addressed by the relevant regulation sections will be alternatively addressed by the proposal;<sup>P</sup> and



(C) A HACCP plan if required as specified under 8-201.13(A) that includes the information specified under 8-201.14 as it is relevant to the variance requested.<sup>Pf</sup>

~~8-103.12 Conformance with Approved Procedures.~~ **8-103.12 Conformance with Approved Procedures.**

If the Department grants a variance as specified in 8-103.10, or a HACCP plan is otherwise required as specified under 8-201.13, the permit holder shall:

(A) Comply with the HACCP plans and procedures that are submitted as specified under 8-201.14 and approved as a basis for the modification or waiver;<sup>P</sup> and

(B) Maintain and provide to the Department, upon request, records specified under 8-201.14(D) and (E) that demonstrate that the following are routinely employed:

- (1) Procedures for monitoring the critical control points,<sup>Pf</sup>
- (2) Monitoring of the critical control points,<sup>Pf</sup>
- (3) Verification of the effectiveness of the operation or process,<sup>Pf</sup> and
- (4) Necessary corrective actions if there is failure at a critical control point.<sup>Pf</sup>

~~8-2 Plan Submission and Approval~~ **PLAN SUBMISSION AND APPROVAL**

~~8-201 Operating Plans~~

~~8-201.13 When a HACCP Plan is Required.~~ **8-201.13 When a HACCP Plan is Required.**

(A) Before engaging in an activity that requires a HACCP plan, a permit applicant or permit holder shall submit to the Department for approval a properly prepared HACCP plan as specified under 8-201.14 and the relevant provisions of this regulation if:

- (1) Submission of a HACCP plan is required by a section of this regulation;
- (2) A variance is required as specified under 3-401.11(D)(4) and 3-502.11;
- (3) The Department determines that a food preparation or processing method requires a variance based on a plan submittal, an inspectional finding, or a variance request.

(B) Before engaging in reduced oxygen packaging without a variance as specified under 3-502.12, a permit applicant or permit holder shall submit a properly prepared HACCP plan to the Department.

~~8-201.14 Contents of a HACCP Plan.~~ **8-201.14 Contents of a HACCP Plan.**

For a retail food establishment that is required under 8-201.13 to have a HACCP plan, ~~the plan and specifications shall indicate all of the following~~ the permit applicant or permit holder shall submit to the Department a properly prepared HACCP plan that includes:

(A) The name of the permit applicant or permit holder, the retail food establishment address, and contact information;

~~(AB) A categorization of the types of time/temperature control for safety foods that are specified in the menu, such as soups and sauces, salads, and bulk, solid foods such as meat roasts, or of other foods that are specified by the Department to be controlled under the HACCP plan;~~<sup>Pf</sup>

~~(BC) A flow diagram or chart for each by-specific food or category type identifying critical control points and providing information on the following that identifies:~~

(1) Each step in the process;<sup>Pf</sup>

(2) The hazards and controls for each step in the flow diagram or chart;<sup>Pf</sup>

(3) The steps that are critical control points;<sup>Pf</sup>

~~(4) Ingredients, materials, and equipment used in the preparation of that food;~~<sup>Pf</sup> and

~~(5) Formulations or recipes that delineate methods and procedural control measures that address the food safety concerns involved;~~<sup>Pf</sup>

~~(C) Food employee and supervisory training plan that addresses the food safety issues of concern;~~

~~(D) A statement of standard operating procedures for the plan under consideration including clearly identifying~~A critical control points summary for each specific food or category type that clearly identifies:

(1) Each critical control point,<sup>Pf</sup>

(2) The critical limits for each critical control point,<sup>Pf</sup>

(3) The method and frequency for monitoring and controlling each critical control point by the food employee designated by the person in charge,<sup>Pf</sup>

(4) The method and frequency for the person in charge to routinely verify that the food employee is following standard operating procedures and monitoring each critical control point,<sup>Pf</sup>

(5) Action to be taken by the designated food employee or person in charge if the critical limits for each critical control point are not met,<sup>Pf</sup> and

(6) Records to be maintained by the person in charge to demonstrate that the HACCP plan is properly operated and managed;<sup>Pf</sup> and

~~(E) Additional scientific data or other information, as required by the Department, supporting the determination that food safety is not compromised by the proposal.~~Supporting documents including:

(1) Food employee and supervisory training plan that addresses the food safety issues of concern;<sup>Pf</sup>

(2) Copies of blank record forms that are necessary to implement the HACCP plan;<sup>Pf</sup> and

(3) Additional scientific data or other information, as required by the Department, supporting the determination that food safety is not compromised by the proposal;<sup>Pf</sup> and

(F) Any other information required by the Department.

## **8-203 Construction Inspection and Approval**

### ~~8-203.10 Preoperational Inspections.~~ **8-203.10 Preoperational Inspections.**

The Department shall conduct preoperational inspection(s) to verify that the retail food establishment is constructed and equipped in accordance with this regulation. The permit holder or representative of the permit holder must request the preoperational inspection fourteen (14) days prior to an inspection to issue a permit.

## **8-3 ~~Permit to Operate~~ PERMIT TO OPERATE**

### **8-301 Requirement**

#### ~~8-301.11 Prerequisite for Operation.~~ **8-301.11 Prerequisite for Operation.**

(A) No person shall operate a retail food establishment without a valid permit to operate issued by the Department.<sup>Pf</sup>

(B) Only a person who complies with the requirements of this regulation shall be entitled to, receive and retain such a permit.

(C) The permit shall be kept in the retail food establishment and shall be accessible at all times.

#### ~~8-301.12 Retail Food Establishment Permits Not Required.~~ **8-301.12 Retail Food Establishment Permits Not Required.**

(A) The following establishments shall not be required to have a permit from the Department:

(1) Churches or charitable organizations where the food service is limited to members and their invited guests.

(2) Churches or charitable organizations who prepare and serve food to the public on their own premises at one function a month or not more than twelve functions a year.

(3) Food service such as soup kitchens and food banks operated by organizations that are providing food at no cost and not for profit or gain to the public who are in need of food assistance.

(4) A bed and breakfast with 10 or fewer rental rooms and a residential kitchen that provides food service.

(5) Retail food establishments or facilities located on United States Government property and regulated by federal authorities.

(6) Retail food establishments or facilities operated by the United States Government.

(7) Retail food establishments or facilities serving solely as commissaries for interstate carriers.

(8) Retail food establishments or facilities on vehicles or common carriers for hire such as airplanes, trains (including maintenance crew cook cars), ships, and other similar conveyances.

(9) Retail food establishments or facilities governed by other regulations when such regulations are determined by the Department to be satisfactory.

(10) Food from retail food establishments outside the jurisdiction of the Department or the State of South Carolina, which is sold within the State of South Carolina if such retail food establishments conform to the provisions of this regulation or to substantially equivalent provisions. To determine the extent of compliance with such provisions, the Department may accept reports from responsible authorities in other jurisdictions where such retail food establishments are located.

(11) Bake sales operated by churches or charitable organizations where homemade cakes, breads, and cookies may be offered for sale only if they are not time/temperature control for safety foods.

(12) Home Based Food Production Operations, which prepare non-time/temperature control for safety foods, such as homemade cakes, breads, cookies, and candy, in a private residence kitchen for sale directly to the end consumer.

(13) Boarding houses, which provide room and board, ~~and~~ which restrict food service to residents only, and do not provide food service to the non-renting public.

(14) Hunt lodges and outdoor-adventure tours that provide room and board as part of a package, and food service is restricted to participants only.

(15) Motels and hotels that prepare non-time/temperature control for safety food breakfast foods or serve pre-packaged food.

(16) Taverns that are primarily engaged in the sale of alcoholic beverages and do not engage in the preparation of food.

(17) Cooking schools or classes where registered students are active participants in preparing the food and are the exclusive consumers of the foods prepared.

(18) Personal chefs that are employed to cook for the owner and occupants of a private residence and their guests. A personal chef may purchase the food and shall prepare, cook and serve the food at the private residence only.

(19) Businesses that serve the following non-time/temperature control for safety foods that use ~~the following considered to have~~ low risk food processes, ~~such as, but not limited to:~~

- (a) Popcorn, cotton candy, candy apples;
- (b) Sno-cones or shaved ice;
- (c) Soft drinks or beverages;
- (d) Nachos served with heated cheese product;
- (e) Commercially dehydrated pre-packaged pork skins; ~~and~~

(f) Pre-formed or prepared pretzels that require baking or warming only; or

(g) Other Department-approved non-time/temperature control for safety foods that use a low risk food process.

(20) An individual, operating out of the individual's dwelling, who prepares and sells the following non-time/temperature control for safety foods that use a low risk food process:

(a) Jams, jellies, preserves, and dried fruits

(b) Dry herbs, seasonings, and mixtures

(c) Vinegar and flavored vinegars

(d) Other Department-approved non-time/temperature control for safety foods that use a low risk food process.

The preparation and sale of food items which present a food safety risk such as acidified foods, low acid canned foods, garlic in oil, and fresh fruit or vegetable juices are not exempt from permitting under this provision.

(201) Businesses that serve the following low risk food processes of time/temperature control for safety foods:

(a) Coffee or coffee based beverages served with pasteurized milk or cream, prepared and served either heated or cold.

(b) Beverages individually prepared upon consumer's request from a commercially pre-packaged powdered mix, prepared without the use of a blender, with no additional ingredients that are time/temperature control for safety foods, and served in a single service cup;

(c) Commercially pre-packaged, pre-cut frozen french fries;

(d) Salt boiled peanuts;

(e) Boiled or grilled corn; ~~or~~

(f) Snow cones or shaved ice served with pasteurized cold milk or cream from a non-reusable container; ~~;~~

(g) Waffle or pancake mix that is commercially pre-packaged and dispensed from self-serve units for service not to exceed four (4) hours in duration. Leftover portions of these products shall be discarded at the end of service; and

(h) Funnel cakes, minidonuts, or similar type products prepared from a single unit having no more than three fryers. Mixed batters shall not be held out of temperature more than four (4) hours. Leftover portions of these products shall be discarded at the end of service.

(21) For the purpose of this provision 8-301.12(A)(21), the low risk food processes of time/temperature control for safety foods shall not include meat, poultry, fish, or game animals.

(22) ~~Vending machines, c~~Convenience stores or other businesses that offer for sale only pre-packaged food from a food processing plant.

~~(23) Vending machines that provide only pre-packaged food from a food processing plant.~~

(B) The Department may require a facility to submit information sufficient to determine if the facility is exempt from the permit requirement or must apply for and obtain a retail food establishment permit. This information may include, but is not limited to, designation of charitable status, leases or proof of ownership, equipment specifications, menus, ingredient lists, food packaging, and food preparation methods.

(C) Although the establishments listed in 8-301.12(A) do not require a permit, the Department retains the authority to conduct an investigation in response to a complaint. The Department may require corrective action and issue orders as deemed necessary in response to food safety or health risks identified during the investigation.

### **8-302 Application Procedure**

#### ~~8-302.11 Submission Thirty (30) Calendar Days Before Proposed Opening.~~ **8-302.11 Submission Thirty (30) Calendar Days Before Proposed Opening.**

An applicant shall submit a complete application for a permit at least thirty (30) calendar days before the date planned for opening a retail food establishment except as specified in 8-303.20 (A)(1)(a).

#### ~~8-302.12 Form of Submission.~~ **8-302.12 Form of Submission.**

A person desiring to operate a retail food establishment shall submit to the Department a written application for a permit on a form provided by the Department.

#### ~~8-302.13 Qualifications and Responsibilities of Applicants.~~ **8-302.13 Qualifications and Responsibilities of Applicants.**

To qualify for a permit, an applicant shall:

(A) Be an owner of the proposed retail food establishment or an officer of the legal entity owning the proposed retail food establishment;

(B) Comply with the requirements of this regulation;

(C) As specified under 8-402.11, agree to allow access to the retail food establishment and to provide required information; and

(D) Pay the applicable Initial Permit/First Year Operational inspection fees of one hundred dollars (\$100.00) plus the applicable annual inspection fee for the anticipated gross sales of food and food products as identified in the table in section 8-304.11(A)(3) at the time the application is submitted. The fee shall be paid prior to the issuance of the permit.

#### ~~8-302.14 Contents of the Application.~~ **8-302.14 Contents of the Application.**

(A) The following application documentation shall be submitted as part of the application process:

- (1) A complete retail food establishment application and any applicable supplement form(s);
  - (2) Menu or list of foods to be served;
  - (3) Anticipated volume of food to be stored, prepared, and sold or served;
  - (4) Approval of variances;
  - (5) Verification of approved drinking water supply;
  - (6) Verification of approved method of sewage disposal;
  - (7) Documentation that the construction of this facility meets the standards set forth in this regulation and all other applicable regulations and codes;
  - (8) For new facilities, based on facility type, proposed layout, mechanical schematics, construction materials, and finish schedules to comply with the applicable sections of the regulation;
  - (9) For new facilities, based on facility type, proposed equipment types, manufacturers, model numbers, locations, dimensions, performance capacities, and installation specifications to comply with the applicable sections of the regulation;
  - (10) Documentation of completed training if required.
- (B) Only when an application has been submitted, is considered complete, and the applicable inspection fee has been paid, may the applicant request a preoperational inspection for the proposed retail food establishment.
- (C) If at any time during the preoperational inspection the information provided during the application process changes or is altered, the Department may require a new application to be submitted.
- (D) The Department shall not issue a permit until the facility is in full compliance with the requirements of this regulation.
- (E) The Department may deny a new permit based on past compliance or enforcement history.

### **8-303 Issuance**

#### **8-303.10 New, Converted, or Remodeled Establishments.**

The Department shall issue a permit to the applicant only after the following are submitted or completed:

- (A) A properly completed application;
- (B) Documentation that the construction of this facility meets the standards set forth in this regulation and all other applicable regulations and codes; and

(C) A preoperational inspection as specified in 8-203.10 shows that the establishment is built or remodeled in accordance with this regulation.

~~8-303.20 Existing Establishments and Change of Ownership.~~ **8-303.20 Existing Establishments and Change of Ownership.**

(A) Routine Change of Ownership.

(1) When a retail food establishment is in the process of changing ownership, the Department shall be notified immediately.

~~\_\_\_\_\_ (a) The new owner shall have fifteen (15) calendar days from the date of the change of ownership to submit a complete application for a new permit as required in 8-302.12 and pay all applicable Department fees.~~

~~\_\_\_\_\_ (b) If the new owner does not submit a complete application and pay applicable fees within the fifteen (15) calendar day period, the retail food establishment will be deemed operating without a permit and shall cease and close all food operations.~~

(2) Within fifteen (15) calendar days from the date of the change of ownership, the new owner shall submit a complete application for a new permit as required in 8-302.12 and pay applicable Department fees as provided in 8-302.13(D).

(23) The Department shall review the application for a change of ownership, and

(a) If the Department determines, pursuant to 8-304.11, the new owner is making changes to the existing permit operations, the change of ownership protocol shall not apply; and

(b) The retail food establishment shall then be subject to all requirements of ~~8-302.12~~8-303.10; and

(c) The facility may be required to close while changes to the facility are evaluated for compliance with the requirements of the regulation. Failure to cease operations and close the facility as required by the Department during evaluation of changes to existing permit operations will constitute operation of a retail food establishment without a permit in violation of this regulation. The facility must remain closed unless and until a new permit is issued to the facility.

(34) Upon receipt of a complete application, the Department will conduct an inspection to determine compliance with Regulation 61-25. A permit shall not be issued to a retail food establishment for a change of ownership if:

(a) The retail food establishment has conditions that constitute an imminent health hazard;~~or~~

(b) Has any priority or priority foundation violations; or

(c) Has a score of 87 or below.

(5) If the new owner fails to submit a complete and timely application, fails to pay applicable fees under (A)(2) of this section, or fails to obtain compliance at the permit inspection under (A)(4)(a) of this section, the retail food establishment shall cease and close all food operations immediately. Any



continued operation of the facility will constitute operation of a retail food establishment without a permit in violation of this regulation. The facility must remain closed until a new permit is issued to the facility.

(6) If the new owner fails to obtain compliance at the permit inspection under (A)(4)(b) or (A)(4)(c), the retail food establishment may continue food operations for a time period not to exceed fifteen (15) calendar days. The retail food establishment must obtain compliance at a follow-up permit inspection during the fifteen (15) day period. If the new owner fails to obtain compliance within the fifteen (15) day period, the retail food establishment shall cease and close all food operations immediately. Any continued operation of the facility will constitute operation of a retail food establishment without a permit in violation of this regulation. The facility must remain closed until a new permit is issued to the facility.

(47) Within ninety (90) calendar days of the permitted change of ownership, the retail food establishment shall be in full compliance with 5-103.11, 5-203.11, 5-203.13, and 5-204.12 of this regulation.

(a) Failure to comply with this requirement will result in permit suspension; and

(b) The permit will then remain suspended until the retail food establishment obtains full compliance with all parts of this regulation.

(B) Change of Ownership in Facilities under Enforcement Action.

(1) Retail food establishments under enforcement action are not eligible for a change of ownership protocol as stated in section (A) above.

(2) A person who wants to take ownership of a retail food establishment under enforcement action shall apply for a new permit and shall provide documentation that demonstrates a bona fide change of ownership. This documentation includes, but is not limited to, a bill of sale for the business, a new lease or bill of sale for the building, a new business or liquor license, or applications for these licenses in the new owner's name, and documentation of management and staffing changes the new owner proposes.

(3) If the Department determines that the change of ownership is bona fide, the Department shall notify the new owner in writing that the retail food establishment is subject to a pending enforcement action and that any and all actions necessary to satisfy the enforcement action must be completed before the Department will issue a permit to the new applicant.

(4) If the Department determines that the change of ownership is not bona fide, the Department shall return the permit application and the inspection fee to the applicant and shall notify the applicant in writing that the retail food establishment is subject to a pending enforcement action and that any and all actions necessary to satisfy the enforcement action must be completed before the Department will process an application for a new permit.

~~8-303.30 Denial of Application for Permit, Notice.~~ **8-303.30 Denial Application for Permit, Notice.**

If an application for a permit to operate is denied, the Department shall provide the applicant with a notice that includes:

(A) The specific reasons and regulation citations for the permit denial;

(B) The actions, if any, that the applicant must take to qualify for a permit.

### **8-304 Conditions of Retention**

~~8-304.10 Responsibilities of the Department.~~ **8-304.10 Responsibilities of the Department.**

(A) At the time a permit is first issued, the permit holder shall demonstrate access to a copy of this regulation and that the permit holder is knowledgeable of the compliance requirements and the conditions of retention, as specified under 8-304.11, that are applicable to the permit.

(B) Failure to provide the information specified in (A) of this section does not prevent the Department from taking authorized action or seeking remedies if the permit holder fails to comply with this regulation or an order, warning, or directive of the Department.

~~8-304.11 Requirement to Comply with Regulation and Conditions of Permit.~~ **8-304.11 Requirement to Comply with Regulation and Conditions of Permit.**

(A) Once a permit has been issued by the Department, the permit holder, in order to retain the permit, shall:

(1) Comply with the provisions of this regulation and all terms and conditions stated on the permit document;

(2) As specified under 8-402.11, agree to allow the Department access to the retail food establishment and to provide required information; and

(3) ~~Meet the requirements of statutes or regulations requiring fees for retail food establishment permits or inspections.~~ Pay to the Department annual inspection fees as follows:

(a) Annually, each retail food establishment shall determine and pay to the Department the applicable inspection fee, based on the gross sales of food and food products for the facility's previous business year, using the table below. As provided in 8-302.13(D), a person or facility applying for an Initial/First Year Operational Permit or change of ownership for a retail food establishment shall determine and pay to the Department the applicable inspection fee using the table below, based on anticipated gross sales of food and food products during the facility's first year of operations. Payment shall be due thirty (30) days from the Department billing date. A penalty charge of fifty dollars (\$50.00) shall be assessed for fees that are thirty (30) days past due. A second penalty charge of fifty dollars (\$50.00) shall be assessed for fees that are sixty (60) days past due. Permit holders of retail food establishments shall furnish previous business year sales information upon request of the Department. This information shall be exempt from disclosure pursuant to the South Carolina Freedom of Information Act, S.C.Code Section 30-4-40(a)(2).

<u>Sales</u>	<u>Fee</u>
<u>\$0-\$250,000</u>	<u>\$100.00</u>
<u>\$250,000 - \$500,000</u>	<u>\$150.00</u>
<u>\$500,000- \$750,000</u>	<u>\$200.00</u>
<u>\$750,000- \$1,000,000</u>	<u>\$250.00</u>
<u>\$1,000,000 - \$1,250,000</u>	<u>\$300.00</u>
<u>\$1,250,000 - \$1,500,000</u>	<u>\$350.00</u>
<u>\$1,500,000 - \$1,750,000</u>	<u>\$400.00</u>

\$1,750,000 and above	\$450.00
-----------------------	----------

(b) Failure to meet the requirements of 8-304.11(A)(3)(a) will result in initial permits not being issued or existing permits being suspended. Retail food establishments that have not paid their inspection fee and late payment penalties after ninety (90) days from the original billing date shall have their permit suspended following service of notice of suspension. The Department may reinstate a permit suspended for failure to pay renewal fees upon payment of the fees, penalties, and a \$25.00 reinstatement fee.

(c) The following retail food establishments shall be exempt from fees:

(i) Retail food establishments that are operated by a public or private school (kindergarten through grade twelve) or that are operated by a child care facility that is licensed and inspected by the Department of Social Services.

(ii) Retail food establishments operated by health care facilities that are regulated and inspected by the Department.

(iii) Retail food establishments operated by other state agencies or local governments that provide food for patients, clients, or inmates.

(iv) Retail food establishments operated by non-profit organizations for the purpose of providing meals or food to needy persons at little or no cost, or for the purpose of raising money for a charitable cause. Non-profit organizations claiming exemption from fee charges shall certify annually to the Department that the organization meets these criteria and, upon request, provide documentation supporting any such certification.

(4) ~~Maintain a copy~~ Have access to and knowledge of this regulation in the retail food establishment. Copies may be ~~obtained from the Department~~ or viewed on the Department website.

(5) Operate as a retail food establishment (serve or sell food) for no less than fifteen (15) consecutive days annually, or be in operation for at least one (1) day a week for no less than fifteen (15) weeks annually.

(B) The Department shall be notified prior to any retail food establishment changes including, but not limited to, the following items:

- (1) Location;
- (2) Service or seating capacity;
- (3) Drinking water or sewage disposal provider;
- (4) Change of hot water generation and distribution system(s);
- (5) Change of ownership;
- (6) Permanent closure;
- (7) Installation of equipment and/or structural modifications;

~~\_\_\_\_\_ (8) A corrected billing or mailing address within ten (10) calendar days of any change of address;~~

~~\_\_\_\_\_ (9) Shared use operations capacity.~~

(C) The Department ~~also~~ shall be notified prior to adding a food item to the menu that:

(1) Involves a food preparation process, which may consist of cooking, cooling, or reheating food, which was not performed in the retail food establishment; or

(2) Poses a health risk to consumers because it is a raw animal food served raw or undercooked.

(D) Once the Department is notified or becomes aware of changes under ~~(A) and (B)~~ or (C) of this section, the Department may amend the permit and may require additional changes as required by this regulation.

(E) Any change under ~~(A) and (B)~~ or (C) of this section, not previously approved or authorized by the Department, may subject the retail food establishment to enforcement action, including, but not limited to, civil penalties, permit suspension, permit revocation, or a combination of these.

~~8-304.20 Permits Not Transferable.~~ **8-304.20 Permits Not Transferable.**

A permit may not be transferred:

(A) From one person or legal entity to another person or legal entity,

(B) From one retail food establishment to another, or

(C) From one type of operation to another if the food operation changes from the type of operation specified in the application and the change in operation is not approved or authorized.

## **8-4 Inspection and Correction of Violations** **INSPECTION AND CORRECTION OF VIOLATIONS**

### **8-402 Access**

~~8-402.11 Access.~~ **8-402.11 Access.**

(A) The Department staff, after proper identification, shall be allowed to enter any retail food establishment at any time the establishment is occupied for the purpose of making an announced, unannounced, or complaint inspection(s) to determine compliance with this regulation.

(B) The Department staff shall be allowed to examine all areas of the facility and all records of the retail food establishment to obtain information pertaining to equipment, food, or supplies purchased, received, or used.

~~8-402.20 Refusal, Notification of Right to Access, and Final Request for Access.~~ **8-402.20 Refusal, Notification of Right to Access, and Final Request for Access.**

If a person denies access to the Department, the Department shall inform the person that:

(A) The permit holder is required to allow access by Department as specified under 8-402.11 of this regulation,

(B) Access is a condition of the acceptance and retention of a retail food establishment permit to operate as specified under 8-304.11, and

(C) If access is denied, the Department may issue an order for access pursuant to 8-402.11, obtain a warrant, or pursue access as allowed by other applicable laws.

~~8-402.30 Refusal, Reporting.~~ **8-402.30 Refusal, Reporting.**

If after the Department presents credentials as specified under 8-402.11, explains the authority upon which access is required, and the person in charge continues to refuse access, the Department shall provide details of the denial of access on an inspection report form.

~~8-402.40 Order to Gain Access.~~ **8-402.40 Order to Gain Access.**

If, after an order has been issued by the Department pursuant to 8-402.20(C), the Department is denied access to a retail food establishment for an authorized purpose and after an order has been issued by the Department pursuant to 8-402.20 (C), the Department may initiate enforcement action under 8-904.110 (B)(4) or other applicable laws including assessment of civil penalties, permit suspension, and/or permit revocation as provided in 8-904.110 and 8-913.10.

~~8-403 Report of Findings~~

~~8-403.10 Documenting Information and Observations.~~ **8-403.10 Documenting Information and Observations.**

(A) The findings shall be recorded on the inspection report, and upon completion of the inspection, the weighted sum of the items in violation shall be totaled and subtracted from one hundred (100) to determine the numerical score.

(B) The Department may use whatever means necessary to record violations, including, but not limited to, electronic inspection programs, manual inspection forms, photographs, video, and printed materials.

(C) Grades of permitted retail food establishments shall be as follows:

(1) Grade A- - A permitted retail food establishment having a rating score of eighty-eight to one hundred (88-100) points.

(2) Grade B- - A permitted retail food establishment having a rating score of seventy eight to eighty seven (78-87) points.

(3) Grade C- - A permitted retail food establishment having a rating score of seventy-seven (77) or less points.

(D) Immediately following each inspection, the Department shall post the appropriate grade decal in the retail food establishment, and shall furnish a copy of the completed inspection report to the permit holder, person in charge, or an employee of the retail food establishment.

(E) A grade decal shall be posted by the Department in a location that is conspicuous to consumers. The retail food establishment shall not obscure, cover, deface, relocate, or remove the posted grade decal.

(F) Notwithstanding the grade criteria established in (C) of this section, when a consecutive violation is discovered, the Department may:

- (1) Schedule appropriate followup- inspections as specified in 8-405.11; or
- (2) Downgrade the retail food establishment to the next lower grade; or
- (3) Suspend the permit.

(G) Notwithstanding the grade criteria established in (C) of this section, there are circumstances and conditions under which the grade decal posted may differ from the numerical score of the inspection report:

- (1) When the retail food establishment is under enforcement action; or
- (2) When the retail food establishment has a consecutive violation(s).
- (3) When, in accordance with S.C. Code Ann. Section 1-23-370 (~~Revised 2005~~), the retail food establishment is under the following pending enforcement actions,
  - (a) Imminent health hazard,
  - (b) Permit suspension, or
  - (c) Permit revocation.

(H) The permit holder or operator of any retail food establishment in which the grade has been lowered may request an inspection for the purpose of re-grading the retail food establishment. The request shall include a signed statement by the permit holder, person in charge, or employee that all violations have been corrected. The Department shall respond to the request within ten (10) calendar days.

~~8-403.20 Specifying Time Frame for Corrections.~~ **8-403.20 Specifying Time Frame for Corrections.**

The Department shall specify on the inspection report form the time frame for correction of the violations as specified under 8-404.11 and 8-405.11.

~~8-403.30 Issuing Report and Obtaining Acknowledgment of Receipt.~~ **8-403.30 Issuing Report and Obtaining Acknowledgment of Receipt.**

A copy of the completed inspection report form shall be furnished to the permit holder, person in charge, or an employee, at the conclusion of the inspection. The report may be furnished in either electronic or printed form.

~~8-403.40 Refusal to Sign Acknowledgement.~~ **8-403.40 Refusal to Sign Acknowledgement.**

The Department shall inform a person who declines to sign an acknowledgment of receipt of inspectional findings as specified in 8-403.30 that:

(A) An acknowledgment of receipt is not an agreement with findings;

(B) Refusal to sign an acknowledgment of receipt will not affect the permit holder's obligation to correct the violations noted in the inspection report within the time frames specified; and

(C) Refusal to sign an acknowledgment of receipt is noted in the inspection report and maintained in the Department's record for the retail food establishment.

~~8-403.50 Public Information.~~ **8-403.50 Public Information.**

The Department shall treat inspection reports as public documents and shall make them available for disclosure to persons upon request as provided in law.

**8-404 Imminent Health Hazard**

~~8-404.11 Imminent Health Hazard.~~ **8-404.11 Imminent Health Hazard.**

(A) The Department, without prior notice or hearing, may suspend the permit to operate a retail food establishment when it is determined that the operation of the retail food establishment constitutes an imminent health hazard to public health except as specified under (E) of this section.<sup>P</sup>

(B) Following permit suspension due to an imminent health hazard, all food service operations shall immediately cease.

(C) The Department shall promptly notify, in writing, the permit holder, person in charge, or an employee, of the specific reasons for which the permit was suspended.

(D) A retail food establishment may voluntarily close prior to the Department declaring an imminent health hazard but shall remain closed until authorized by the Department to resume operations.

(E) A permit holder may continue operations in areas of the establishment that are unaffected by the imminent health hazard.

(F) Considering the nature of the potential hazard involved and the complexity of the corrective action needed, the Department may, but is not required to, agree to continuing operations in the event of an extended interruption of electrical or water service if:

(1) A written emergency operating plan has been approved by the Department;

(2) Immediate corrective action is taken to eliminate, prevent, or control any food safety risk and imminent health hazard associated with the electrical or water service interruption; and

(3) The Department is informed upon implementation of the written emergency operating plan.

~~8-404.12 Resumption of Operations.~~ **8-404.12 Resumption of Operations.**

(A) If operations are discontinued as specified under 8-404.11 or otherwise according to law, the permit holder shall obtain approval from the Department before resuming operation.

(B) Notwithstanding 8-904.20, a permit suspended for an imminent health hazard shall remain suspended until the imminent health hazard has been corrected.

## **8-405 Correction of Violations**

### ~~8-405.11 Correction of Violations.~~ **8-405.11 Correction of Violations.**

(A) The completed inspection report form shall specify a period of time for the correction of the violations found. Implementation of corrective action of all violations shall be within the following specified time periods:

(1) All priority and priority foundation violations shall be corrected immediately. Considering the nature of the potential hazard involved and the complexity of the corrective action needed, the Department may schedule a follow-up inspection not to exceed ten (10) calendar days from the date of the inspection. <sup>pf</sup>

(2) ~~When the rating score of the retail food establishment is in the Grade A or B range, a~~ All core violations that are operational shall be corrected as soon as possible. Verification of correction will be made at the time of the next routine inspection or earlier if deemed necessary by the Department.

(3) Except as specified in (4) of this section, all consecutive core violations shall be corrected as soon as possible. A follow-up inspection shall be conducted to confirm correction within ten (10) calendar days from the date of the inspection.

(4) All core violations that are structural shall be corrected by the next routine inspection; however, additional time, not to exceed twelve (12) months, may be granted when such allowances present no public health hazard and the permit holder provides a written schedule for compliance.

(B) When a retail food establishment's routine inspection score is in the Grade C range or lower (less than 78 points), a subsequent routine inspection must be performed within sixty (60) calendar days of that C grade or lower inspection.

(C) Other than occurrences where a third consecutive inspection is rated below seventy (70) as described in 8-904.110 (C), when the rating score of the retail food establishment is less than seventy (70):

(1) The retail food establishment shall be downgraded to a grade C.

(2) Immediate corrective action on all identified priority, ~~and~~ priority foundation, ~~violations~~ and core violations shall be initiated. <sup>pf</sup>

(a) If priority and priority foundation violations cannot be corrected immediately the retail food establishment will be given the opportunity to cease all operations and close the facility voluntarily.

(b) If the retail food establishment refuses to cease operations voluntarily, the Department shall declare an imminent health hazard under 8-404.10.<sup>p</sup>

(3) Once a retail food establishment is closed, the retail food establishment will be allowed to reopen when all priority and priority foundation violations are corrected, as determined by the Department.



(4) A follow-up inspection shall be conducted within seventy-two (72) hours from the date of the inspection and as often as necessary to assure correction. If the retail food establishment fails to score seventy (70) or above on the follow-up inspection, action to suspend the permit shall be initiated.

## **8-5 Prevention of Foodborne Disease Transmission by Employees** **PREVENTION OF** **FOODBORNE DISEASE TRANSMISSION BY EMPLOYEES**

### **8-501 Investigation and Control**

~~8-501.10 Obtaining Information: Personal History of Illness, Medical Examination, and Specimen Analysis.~~ **8-501.10 Obtaining Information: Personal History of Illness, Medical Examination, and Specimen Analysis.**

The Department shall act when it has reasonable cause to believe that a food employee or conditional employee has possibly transmitted disease; may be infected with a disease in a communicable form that is transmissible through food; may be a carrier of infectious agents that cause a disease that is transmissible through food; or is affected with a boil, an infected wound, or acute respiratory infection, by:

(A) Securing a confidential medical history of the food employee or conditional employee suspected of transmitting disease or making other investigations as deemed appropriate; and/or

(B) Requiring appropriate medical examinations, including collection of specimens for laboratory analysis, of a suspected food employee or conditional employee.

~~8-501.20 Restriction or Exclusion of Food Employee, or Summary Suspension of Permit.~~ **8-501.20 Restriction or Exclusion of Food Employee, or Summary Suspension of Permit.**

Based on the findings of an investigation related to a food employee or conditional employee who is suspected of being infected or diseased, the Department may issue an order to the suspected food employee, conditional employee or permit holder instituting one or more of the following control measures:

(A) Restricting the food employee or conditional employee;

(B) Excluding the food employee or conditional employee; or

(C) Closing the retail food establishment by summarily suspending a permit to operate in accordance with law.

~~8-501.30 Restriction or Exclusion Order: Prior Warning or Hearing Not Required, Information Required in Order.~~ **8-501.30 Restriction or Exclusion Order: Prior Warning or Hearing Not Required, Information Required in Order.**

Based on the findings of the investigation as specified in 8-501.10 and to control disease transmission, the Department may issue an order of restriction or exclusion to a suspected food employee or the permit holder without prior warning, notice of a hearing, or a hearing if the order:

(A) States the reasons for the restriction or exclusion that is ordered;

(B) States the evidence that the food employee or permit holder shall provide in order to demonstrate that the reasons for the restriction or exclusion are eliminated; and

(C) States that the suspected food employee or the permit holder may request a hearing as provided in law.

~~8-501.40 Removal of Exclusions and Restrictions.~~ **8-501.4 Removal of Exclusion and Restrictions.**

A food employee, or conditional employee shall be released from restriction or exclusion when the employee or conditional employee no longer poses a threat to the public health.

## **8-6 Constitutional Protection CONSTITUTIONAL PROTECTION**

### **8-602 Judicial Review**

~~8-602.10 Rights of Recipients of Orders or Decisions.~~ **8-602.10 Rights of Recipients of Orders or Decisions.**

A recipient of a Department decision or order may appeal the decision or order in accordance with applicable law.

## **8-7 Authority AUTHORITY**

### **8-701 Legal Authority**

~~8-701.10 Adoption of Regulations and Enforcement.~~ **8-701.10 Adoption of Regulations and Enforcement.**

(A) This regulation is issued under the authority of S.C. Code of Laws, Section 44-1-140 (Revised 2002), and shall be enforced by the Department.

(B) Should any chapter, paragraph, sentence, clause, or phrase of this regulation be declared unconstitutional or invalid for any reason, the remainder of this regulation shall not be affected thereby.

~~8-701.11 Implementation of Regulations.~~

~~— (A) The cold holding temperature of 41 degrees F (5 degrees C) or below and the hot holding temperature of 135 degrees F (57 degrees C) or above shall not be effective until two (2) years after the effective date of this regulation. During this two (2) year period, the cold holding temperature shall be 45 degrees F (7 degrees C) or below and the hot holding temperature shall be 130 degrees F (54 degrees C) or above.~~

~~— (B) Date marking as specified in 3-501.17, shall not be effective until two (2) years after the effective date of this regulation.~~

~~— (C) All retail food establishments with a permit on the effective date of this regulation shall have two (2) years to comply with the requirements of section 2-102.11, *Demonstration* 2-102.20, *Food Protection Manager Certification*~~

~~8-701.20 Enforcement.~~ **8-701.2 Enforcement.**

Any facility found to be in violation of this regulation, in non-compliance with the requirements of this regulation, or in violation of an order issued by the Department shall be subject to civil penalties, permit suspension, and/or revocation pursuant to S.C. Code Ann. Section 44-1-150 (Supp. 2012) and this regulation.

## **8-9 Remedies REMEDIES**

### **8-903 Holding, Examination, and Destruction of Food**

#### ~~8-903.10 Hold Orders, Justifying Conditions, and Removal of Food.~~ **8-903.1 Hold Orders, Justifying Conditions, and Removal of Food.**

(A) The Department may place a hold order on a food which is believed to be in violation of this regulation that:

- (1) Originated from an unapproved source;
- (2) May be unsafe, adulterated, or not honestly presented;
- (3) Is not labeled according to law, or, if raw molluscan shellfish, is not tagged or labeled according to law; or
- (4) Is otherwise not in compliance with this regulation.

(B) Should the hold order be violated, action may be initiated to suspend the permit.

(C) The Department may condemn, forbid the sale of, or cause to be removed or destroyed, any food, which is determined to be in violation of this regulation, unwholesome, contaminated, adulterated, or from an unapproved source.

#### ~~8-903.20 Hold Order, Prior Warning, or Hearing Not Required.~~ **8-903.2 Hold Order, Prior Warning, or Hearing Not Required.**

The Department may issue a hold order to a permit holder or to a person who owns or controls the food, as specified in 8-903.10, without prior warning, notice of a hearing, or a hearing on the hold order.

#### ~~8-903.30 Hold Order, Contents.~~ **8-903.30 Hold Order, Contents.**

The hold order shall:

(A) State that food subject to the order may not be used, sold, moved from the retail food establishment, or destroyed without a written release from the Department;

(B) State the specific reasons for placing the food under the hold order with reference to the applicable provisions of this regulation and the hazard or adverse effect created by the observed condition;

(C) Completely identify the food subject to the hold order by the common name, the label information, a container description, the quantity, tag or identification information, and location;

(D) State that the permit holder has the right to a hearing and may request a hearing in accordance with applicable law; and

(E) State that the Department may order the destruction of the food if a timely request for a hearing is not received.

~~8-903.40 Hold Order, Official Tagging of Food.~~ **8-903.4 Hold Order, Official Tagging of Food.**

(A) The Department shall securely place an official tag or label on the food or containers or otherwise conspicuously identify food subject to the hold order.

(B) The tag or other method used to identify a food that is the subject of a hold order shall be signed and dated by the Department.

~~8-903.51 Hold Order, Food May Not Be Used or Moved.~~ **8-903.5 Hold Order, Food May Not Be Used or Moved.**

(A) Except as specified in (B) of this section, a food placed under a hold order may not be used, sold, served, or moved from the establishment by any person.

(B) The Department may allow the permit holder the opportunity to store the food in an area of the retail food establishment if the food is protected from subsequent deterioration and the storage does not restrict operations of the establishment.

~~8-903.70 Hold Order, Removing the Official Tag.~~ **8-903.70 Hold Order, Removing the Official Tag.**

Only the Department may remove hold order tags, labels, or other identification from food subject to a hold order.

~~8-903.80 Destroying or Denaturing Food.~~ **8-903.80 Destroying or Denaturing Food.**

If a hold order is sustained upon appeal or if a timely request for a hearing is not filed, the Department may order the permit holder or other person who owns or has custody of the food to bring the food into compliance with this regulation or to destroy or denature the food under the Department's supervision.

~~8-903.90 Releasing Food from Hold Order.~~ **8-903.90 Releasing Food from Hold Order.**

The Department shall issue a notice of release from a hold order and shall remove hold tags, labels, or other identification from the food if the hold order is vacated.

## **8-904 Summary Permit Suspension**

~~8-904.10 Conditions Warranting Action~~ **8-904.10 Conditions Warranting Summary Suspension.**

The Department may summarily suspend a permit to operate a retail food establishment if it determines through inspection, or examination of employees, food, records, or other means as specified in this regulation, that an imminent health hazard exists.

~~8-904.20 Summary Suspension, Warning, or Hearing Not Required.~~ **8-904.20 Summary Suspension, Warning, or Hearing Not Required.**

The Department may summarily suspend a retail food establishment's permit by providing written notice of the summary suspension to the permit holder or person in charge, without prior warning, notice of a hearing, or a hearing.

~~8-904.30 Contents of the Notice.~~ **8-904.30 Contents of the Summary Suspension Notice.**

A summary suspension notice shall state:

(A) That the retail food establishment permit is immediately suspended and that all food operations shall immediately cease;

(B) The reasons for summary suspension with reference to the provisions of this regulation that are in violation;

(C) The name and address of the Department representative to whom a written request for re-inspection may be made and who may certify that reasons for the suspension are eliminated; and

(D) That the permit holder may request a hearing in accordance with applicable law.

~~8-904.40 Time Frame for Re-inspection.~~ **8-904.40 Time Frame for Re-inspection.**

After receiving a written request from the permit holder stating that the conditions cited in the summary suspension order no longer exist, the Department shall conduct a re-inspection of the retail food establishment for which the permit was summarily suspended within five (5) business days, which means five (5) days during which the Department's office is open to the public.

~~8-904.50 Term of Suspension, Reinstatement of Permit.~~ **8-904.50 Term of Summary Suspension, Reinstatement of Permit.**

(A) A summary suspension shall remain in effect, until the conditions cited in the notice of suspension no longer exist, and the Department, through re-inspection, has confirmed their elimination and other means as appropriate.

(B) The suspended permit shall be reinstated if the Department determines that the public health hazard or nuisance no longer exists. A notice of reinstatement shall be provided to the permit holder or person in charge.

~~8-904.110 Suspension of Permits.~~ **8-904.110 Suspension of Permits.**

(A) The Department may suspend permits for:

- (1) Consecutive priority and priority foundation violations;
- (2) Consecutive core violations;
- (3) Below seventy (70) inspection scores;
- (4) Failure to comply with the terms and conditions of the permit;

(5) Failure to notify the Department of facility changes and to seek amendments to a permit as required by Section 8-304.11;

(6) Failure to provide the Department access to the retail food establishment for the purpose of conducting an inspection or investigation;

(7) Covering, obscuring, defacing, relocating, or removing the posted grade decal or permit;

(8) Violation of a hold order;

(9) Failure to pay applicable inspection renewal fee or failure to pay a civil penalty required pursuant to a Department order;

(10) Failure to operate as a retail food establishment (serve or sell food) for at least fifteen (15) consecutive days annually or be in operation for at least one day every week for at least fifteen (15) weeks.

~~(10)~~ As otherwise determined by the Department pursuant to 8-102.10.

(B) The Department may revoke permits for:

(1) Recurring failure to notify the Department of facility changes or to seek amendments to the permit;

(2) Recurring failure to comply with the Terms and Conditions of the permit;

(3) Recurring priority and priority foundation violations of the regulation;

(4) Recurring failure to provide the Department access to the retail food establishment for the purpose of conducting an inspection or investigation; ~~or~~

(5) Three (3) routine inspections in a two (2) year period that have a rating score of below seventy (70); ~~or~~

(6) Failure to operate as a retail food establishment (serve or sell food) for at least fifteen (15) consecutive days annually or be in operation for at least one day every week for at least fifteen (15) weeks.

(C) When a facility has a rating score of below seventy (70):

(1) On the second routine inspection, Department staff shall be accompanied by an additional representative for verification of violations.

(2) When ~~this~~ the second routine inspection results in a score below seventy (70), the Department shall notify the permit holder, by letter, that if on the next routine inspection, the score is less than seventy (70), action will be initiated to revoke the permit.

(3) On the third routine inspection, Department staff shall be accompanied by a standardization officer of the Department.

~~8-904.120 Notification of Permit Suspension and Permit Revocation~~ **8-904.120 Notification of Permit Suspension and Permit Revocation.**

Except as provided in 8-904.20, ~~Prior~~ prior to permit suspension or permit revocation, the Department shall notify, in writing, the permit holder, person in charge, or an employee, of the specific reasons for which the permit is to be suspended or revoked.

~~8-904.130 Term of Suspension, Reinstatement of Permit~~ **8-904.130 Term of Suspension, Reinstatement of Permit.**

A permit suspension shall remain in effect until the conditions cited in the notice of permit suspension no longer exist and their elimination has been confirmed by the Department through re-inspection and other means as appropriate.

~~8-904.140 Interference with the Department~~ **8-904.140 Interference with the Department.**

Notwithstanding any other provisions of this regulation, the permit shall be revoked if a permit holder, person in charge, or employee engages in any of the following actions towards Department staff while performing, or as a result of performing, official duties and responsibilities:

- (A) Physical or verbal actions that constitute assault, battery, sexual or other harassment, or
- (B) Interference, intimidation, threat, or attempted bribery.

## **8-905 Appeals**

~~8-905.10 Appeals~~ **8-905.10 Appeals.**

A Department decision to deny an application for a permit, deny a request for a variance, impose a penalty, or suspend or revoke a permit may be appealed pursuant to applicable law.

8-905.40 Hearings and Appeals Procedures.

All appeals and hearings shall be conducted in accordance with applicable law.

## **8-913 Civil Penalties**

~~8-913.10 Penalties~~ **8-913.10 Penalties.**

Civil penalties for violations of this regulation or an order of the Department may be imposed pursuant to S.C. Code Ann. Section 44-1-150 (Supp. 2012).

## **Chapter 9 Standards for Additional Retail Food Establishment Operations**

### **9-1 Mobile Food MOBILE FOOD**

This standard shall apply to the construction and operation of mobile food units as part of a retail food establishment.

#### **(A) Definitions.**

(1) A **mobile food establishment** of a commissary and mobile food unit(s) or mobile food pushcart(s). The food service portion of the operation is conducted from a movable driven or propelled vehicle, portable structure, or watercraft that can change location.

(2) A **commissary** permitted retail food establishment that is authorized by the Department to provide support of operations, storage, and servicing area for mobile food units or mobile food pushcarts, and is constructed and operated in compliance with the requirements of this regulation and standard. Retail food establishments that prepare and serve food to highly susceptible populations such as those operated by health care facilities that are regulated by the Department shall not be approved as a commissary.

(3) **Mobile food units** fully enclosed mobile kitchens that may prepare, cook, or serve time/temperature control for safety foods as an extension of the commissary. A mobile food unit must be permitted by the Department in order to operate from a retail food establishment.

(4) **Mobile food pushcarts** limited food service units that operate as an extension of a commissary. A mobile food pushcart must be permitted by the Department in order to operate from a commissary.

#### **(B) General.**

(1) A mobile food establishment shall comply with all applicable provisions of this regulation, except as outlined in this standard.

(2) The Department may prohibit the sale of certain time/temperature control for safety foods, and may modify specific requirements for physical facilities when, in the opinion of the Department, no health hazard will result.

(3) ~~Mobile food units and mobile pushcarts shall return to the commissary after each day of operation and shall be stored onsite at the commissary.~~ For servicing and storage:

(a) A full-service (self-contained) mobile food unit must return to the commissary at a frequency necessary to maintain sanitary conditions but in no case may operate for longer than seventy-two (72) hours of operation without returning to the commissary.

(b) Non-self-contained mobile food unit(s) and mobile pushcart(s) must return to the commissary within twenty-four (24) hours of operation.

(c) Mobile food unit(s) and mobile pushcart(s) that are not stored at the commissary must submit the proposed storage location for Department approval.

#### **(C) Employees.**

(1) Food employees shall not contact exposed, ready-to-eat-food with their bare hands and shall use suitable utensils such as deli tissue, spatulas, tongs, single-use gloves, or dispensing utensils.

(2) Personal clothing and belongings should be stored in a designated place away from food preparation, food service, dry storage areas, utensil and single-service article storage, and utensil washing areas.

#### **(D) Food.**



(1) General.

*Food* (a) A mobile food establishment shall prepare, hold, and serve food according to Chapter 3,

(b) All food items shall be protected from contamination during transportation, storage, cooking, display, and service.

(c) Adequate refrigeration or coolers shall be provided. A temperature measuring device shall be provided for cold holding units.

(d) Packaged food may not be stored in direct contact with ice or water if the food is subject to the entry of water because of the nature of its packaging, wrapping, or container or its positioning in the ice or water.

(e) Ice used as a coolant for foods shall not be used for edible ice.

(f) For the purpose of checking temperatures of food, a mobile food establishment shall have at least one temperature measuring device that meets the following requirements:

~~(i) Sealed 0 to 220 degrees F (-18 to 104 degrees C); and~~

~~(ii) Able to be calibrated; and~~

~~(iii) Appropriate for the food density being checked.~~

(g) Hot held time/temperature control for safety foods on a mobile food unit or mobile pushcart shall be discarded at the end of the day at the commissary.

(h) Food(s) shall be stored, displayed, and served from the mobile food unit(s) and mobile food pushcart(s) only.

(2) Mobile Food Unit.

(a) Preparation of bulk food, including washing, slicing, peeling, and cutting, shall occur at the commissary.

(b) All food, single-service articles, and other items used for the operation of the mobile food unit shall be stored at the commissary or on the mobile food unit.

(c) Doors on mobile food units shall be kept closed at all times.

(3) Mobile Food Pushcart.

(a) All food, single-use articles, and other items used for the operation of the mobile food pushcart shall be stored at the commissary.

(b) Other than assembling food items for service, all food preparation, including washing, slicing, peeling, cutting, and cooking, shall occur at the commissary.

(c) Raw animal food shall not be cooked or prepared in any way on a mobile food pushcarts.

(d) Door(s) on mobile food pushcarts shall be kept closed when not in use and during transportation.

**(E) Service.**

(1) During operations, food shall be stored, cooked, displayed, and served from the mobile food unit and mobile food pushcart only.

(2) Customer self-service of unpackaged time/temperature control for safety food is prohibited.

(3) Mobile food units and mobile food pushcarts shall provide only single-use articles for use by the consumer.

(4) Condiments shall be protected from contamination by being kept in dispensers that are designed to provide protection or offered in individual packages.

(5) Equipment and utensils shall be adequate in number and where appropriate shall be washed, rinsed, and sanitized as needed.

(6) In-use wiping cloths must be stored in a clean solution of an approved sanitizer.

(7) A test kit that accurately measures the parts per million concentration of an approved sanitizer shall be accessible and used.

**(F) Construction.**

(1) Mobile food units.

(a) Mobile food units shall have preparation and display areas completely enclosed with a solid material except as specified in (j) of this section.

(b) The serving window opening shall:

(i) Have an area of no more than five hundred seventy-six (576) square inches~~Be no more than two (2) feet long by two (2) feet wide~~, and

(ii) Be covered with solid material or screen. Screening shall be at least sixteen (16) mesh per inch.

(iii) Be self-closing or free falling type, or covered by an approved air curtain when the serving window is open.

(c) Walls, floors, and ceilings must be smooth, cleanable, durable, and nonabsorbent.

(d) Light bulbs and fluorescent tubes shall be shielded, coated, or otherwise shatter-resistant and provide twenty (20) foot candles of illumination.

(e) Cooking and reheating equipment shall be installed on the unit, and used in accordance with the manufacturer's instructions, and must meet the provisions of this regulation. Pull behind cookers or smokers are prohibited.

(f) All mobile food unit counters, shelves, and food contact surfaces shall be safe, corrosion resistant, nonabsorbent, smooth, easily cleanable, durable, and free of seams and difficult to clean areas.

(g) It is not the intent for mobile food units to wash, rinse, and sanitize utensils or equipment on the mobile food unit due to hot water demands. If mobile food units are designed to be self sufficient, a utensil washing sink shall:

(i) Have at least three (3) compartments large enough to accommodate two thirds of the largest utensil, and

(ii) Have adequate space for air-drying, and

(iii) Be supplied with hot ~~&~~and cold water under pressure, and

(iv) Be equipped with a mixing faucet that is capable of servicing all sink compartments per 4-301.12.

(h) Mechanical exhaust ventilation equipment shall be provided over all cooking equipment as required to effectively remove cooking odors, smoke, steam, grease, heat, and vapors.

(i) All mechanical exhaust ventilation equipment shall be installed and maintained in accordance to 4-301.14.

(j) Barbecue pit-cooking areas on mobile units must comply with 9-7, *Barbecue Pit And Pit-Cooking Room Construction*.

(2) Mobile food pushcarts.

(a) Mobile food pushcarts shall have preparation and display areas completely enclosed with a solid material.

(b) Food compartment(s) and food storage compartments must be adequately sized for the intended operation of the mobile food pushcart.

(c) Food compartments must be constructed from materials that are nontoxic, smooth, easily cleanable, ~~and~~ durable, and constructed to facilitate the cleaning of the interior and exterior of the compartment.

(d) Food storage compartments shall not contain plumbing of any kind.

(e) All mobile food pushcart counters/shelves and food contact surfaces shall be safe, corrosion resistant, nonabsorbent, smooth, easily cleanable, durable, and free of seams and difficult to clean areas.

### **(G) Handwashing Sinks.**

(1) All mobile food units and mobile food pushcarts shall have a separate handwashing sink.

(2) Soap and disposable paper towels shall be provided and adjacent to the handwashing sink.

(3) The handwashing sink shall be:

(a) Equipped with hot and cold water under pressure through a mixing valve or combination faucet. The hot water temperature shall be at least 100 degrees F (37 degrees C) as specified in 5-202.12; and

(b) Separated from food and food contact surfaces by either a splashguard or a distance of at least 12 inches; and

(c) Unobstructed and accessible to employees at all times.

(4) Gloves and/or hand sanitizers shall not be allowed as a substitute for handwashing facilities.

### **(H) Water System.**

(1) All mobile food units and mobile food pushcarts shall have a drinking water system, under pressure, from an approved drinking water supply system.

(2) Mobile food units and mobile food pushcarts water tanks shall comply with 5-3 of this regulation.

(3) Approved portable drinking water containers shall be stored and handled in a manner that protects the drinking water and equipment from contamination.

(4) The drinking water system tank shall be a minimum of five (5) gallons and of sufficient capacity to furnish hot and cold water for handwashing as specified in 5-202.12.

(5) If the mobile food unit is designed to be self sufficient, the hot water system shall be sufficient to meet hot water demands of at least ~~120~~110 degrees F (~~483~~degrees C) to the utensil washing sink and comply with all requirements pursuant to 5-103.11.

(6) A mobile food unit or mobile pushcart may temporarily use a direct connection to an approved drinking water source at the operating location when the following criteria are met:

(a) The mobile unit is connected to an approved public sewer or onsite wastewater system and

(b) Drinking water and sewage storage tanks remain on the unit at all times.

### **(I) Sewage Retention.**

(1) Mobile food units and mobile food pushcarts water tanks shall comply with 5-3 of this regulation.

(2) Sewage from a mobile pushcart may be stored in a removable retention tank that:

(a) Shall be fifteen (15) percent larger capacity than the drinking water supply tank;

(b) Cannot exceed ten (10) gallons (80 lbs) to be approved as portable;

(c) If sewage retention tanks are removable, they shall be permanently labeled 'sewage' to eliminate any confusion;

(d) Permanently installed sewage retention tanks on mobile pushcarts shall meet the same requirements as specified in (1) and (2) of this section.

(3) The mobile food unit and mobile pushcart sewage retention tank shall be thoroughly flushed and drained during the servicing operations ~~only at the commissary or approved sewage disposal site,~~ and shall be discharged into a sanitary sewerage disposal system or onsite sewage system approved by the Department.

(4) Flushing and draining shall be done in a manner that does not contaminate floors or any other areas in the commissary or the servicing area.

### **(J) Servicing Area.**

The surface of the servicing area shall be constructed of a smooth material, such as concrete or asphalt, and shall be maintained in good repair, kept clean, and be properly drained.

### **(K) Exemptions.**

(1) A mobile food pushcart operated inside fully enclosed structures such as, but not limited to, malls or sports arenas may have the requirement for full enclosure waived if in the opinion of the Department, no risk of contamination to the food exists.

(2) Mobile food pushcarts that are used to serve ~~precooked~~ commercially packaged, fully cooked boiled or steamed hot dogs with ~~precooked~~ commercially packaged, fully cooked chili or ice cream may have the requirement for full enclosure waived if in the opinion of the Department, no risk of contamination to the food exists provided those are the only foods served from the unit.

~~(3) Mobile food pushcarts are exempt from the requirements for training certification in 2-102.20.~~

### **(L) Compliance.**

(1) No mobile food unit or a mobile food pushcart shall operate that does not have a permit issued by the Department.

(2) Only a mobile food establishment that complies with the requirements of this regulation and this standard shall be entitled to receive and retain a permit.

(3) The permit shall be kept in the mobile food unit or mobile food pushcart and shall be accessible at all times.

(4) No retail food establishment shall operate as a commissary that does not have an authorization issued by the Department.

(5) Only a retail food establishment that complies with the requirements of this regulation and this standard shall be entitled to, receive and retain such an authorization.

(6) The permit and authorization shall be kept in a location in the commissary and shall be accessible at all times as specified in 8-301.11.

(7) Any person that proposes to operate a mobile food unit or mobile food pushcart must apply to the Department for a permit through the application process.

(8) The following additional documentation shall be submitted as part of the application process:

~~(a) Drawings showing all food preparation and cooking, mechanical, electrical, and plumbing systems of the mobile food unit or mobile food pushcart;~~

(~~b~~a) A proposed menu or list of foods that will be served from the mobile food unit or mobile food pushcart;

(~~e~~b) A list of all equipment installed on the mobile food unit or mobile food pushcart;

(~~d~~c) An operations plan that includes:

(i) Information about methods of cooking, if applicable, ~~and~~

(ii) Hot and cold holding of food, ~~and~~

(iii) The mobile food unit or mobile food pushcart operational locations and the hours of operation at those locations, ~~and~~

(iv) The location of the commissary, and the cleaning and servicing operations at the commissary, ~~and~~

(v) A supplemental application form completed by the permit holder for each mobile food unit or mobile food pushcart; and

(vi) Any other information requested by the Department.

(9) Once a mobile food unit or mobile food pushcart has been permitted, the Department shall be notified of any changes to the mobile food unit or mobile food pushcart, such as, but not limited to, operations, menu, or change in commissary in accordance with 8-304.11.

(10) The mobile food unit or mobile food pushcart shall be available for inspection at the commissary at any reasonable time when requested by the Department.

(11) If a mobile food unit or mobile food pushcart is not presented for inspection at the commissary at the appointed time, the commissary permit and mobile food unit or mobile food pushcart permit shall be suspended in accordance with 8-904.110.

(12) Each mobile food unit and mobile pushcart shall have its business name, ~~commissary permit number, commissary name~~ and address legibly printed in ~~three (3) inch high letters on the mobile food unit. The letters must be~~ of a contrasting color from the color of the mobile food unit or mobile food pushcart and visible at all times in a manner that is conspicuous to the consumer.

(13) Mobile food units or mobile food pushcarts currently permitted prior to the effective date of this regulation and in compliance with the previous regulation, but which do not fully comply with all the

construction, equipment, and physical requirements of this regulation, shall be deemed acceptable provided the facilities and equipment:

(a) Are capable of being maintained in a sanitary condition; ~~and~~

(b) Are not a public health hazard or nuisance; and

(c) Are replaced in the normal course of operation with equipment and facilities that meet the requirements of this standard and regulation.

## **9-2 Transportation and Sale of Meat/Meat Products, Seafood and Freshwater MEAT/MEAT PRODUCT AND FISH/FISH PRODUCT SALES**

This standard shall apply to ~~the transportation and sale of meat/meat products, seafood and freshwater fish/fish products from source or preparation site to the point of sale.~~

### **(A) General.**

(1) Meat/meat products, ~~seafood~~ and freshwater fish/fish products shall be protected from contamination by use of packaging or covered containers while being transported.

(2) ~~All food~~ Meat/meat products and fish/fish products being transported shall meet the requirements and sections of this regulation relating to approved source, food supplies, food protection, food storage, and sanitary control of liquid waste.

(3) Acceptable products for meat/meat products, ~~and seafood and freshwater fish/fish products~~ sales under this standard are as follows:

(a) Prepackaged frozen meat, ~~seafood,~~ and ~~freshwater~~ fish/fish products, which are processed and packaged in an approved food processing plant and are sold by the package or case, ~~or~~

(b) Fresh unprocessed ~~freshwater~~ fish/fish products and ~~seafood~~ from an approved source which are whole, or

(c) Fresh unprocessed shrimp with either the heads on or heads removed.

### **(B) Employees.**

Meat/meat products, ~~and~~ seafood and freshwater fish shall be delivered by persons with clean hands and wearing clean clothing.

### **(C) Food.**

(1) All food/ices shall be obtained from ~~approved sources~~ approved by the Department.

(2) Meat/meat products, ~~seafood~~ and ~~freshwater~~ fish/fish products shall be protected from contamination when transported with other products.

(3) All food employees shall hold and display food according to all applicable sections of Chapter 3, *Food*

(4) Packaged food may not be stored in direct contact with ice or water if the food is subject to the entry of water because of the nature of its packaging, wrapping, or container, or its positioning in the ice or water.

(5) Whole unpackaged ~~freshwater fish/fish products and seafood~~ may be stored in ice made from drinking water or obtained from an approved source.

(6) Ice used as a coolant for foods shall not be used for edible ice.

(7) ~~Vehicles transporting~~ During transport of meat/meat products, ~~seafood~~ and ~~freshwater fish/fish products~~, shall have there shall be at least one temperature measuring device for checking temperatures of food that meets the following requirements:

(a) ~~Scaled 0 to 220 degrees F (-18 to 104 degrees C); and~~

(~~b~~a) Able to be calibrated; and

(~~e~~b) Appropriate for the food density being checked.

(8) All fresh meat/meat products, ~~seafood~~ and ~~freshwater fish/fish products~~ shall be transported so as to maintain a temperature of 41 degrees F (5 degrees C) or below during the transportation period.

#### **(D) Cleanliness/Construction/Vehicle Maintenance.**

(1) ~~Vehicles need not be refrigerated if meat/ and meat products and fish/fish products reach their destination at 41 degrees F (5 degrees C) or below, vehicles need not be refrigerated.~~

(2) The storage portion of each vehicle shall be washed and cleaned.

### **9-3 Outdoor Pet Dining/OUTDOOR PET DINING**

This standard shall apply to outdoor dining areas where table service of food is provided and shall not apply to customer pick up take out service with picnic type dining areas that may be provided by a retail food establishment

#### **(A) Definition.**

A **pet**s defined as domesticated cats, dogs, and ferrets.

#### **(B) General.**

(1) A retail food service establishment may allow customers to be accompanied by pets in an outdoor dining area provided the retail food service establishment complies with the requirements of this section and all other applicable sections of this regulation.

(2) Pets at retail food establishments shall also comply with the South Carolina Rabies Control Act Section 47-5-60.

#### **(C) Employees.**

Employees shall wash hands after any contact with pets, pet supplies, and pet waste.



**(D) Service.**

- (1) All tableware used for the pets shall be restricted to single-service or single-use articles.
- (2) Tables and chairs located in the outdoor pet dining area shall be easily cleanable.
- (3) Cleaning supplies and sanitizers shall be provided and stored in the outdoor pet dining area. These items shall be exclusively used for outdoor pet dining purposes only and stored outside.
- (4) Cleaning equipment necessary for the removal of pet waste shall be provided. These items shall be exclusively used for outdoor pet dining purposes only and stored outside.
- (5) Pet waste shall be removed immediately and the area shall be cleaned and sanitized.
- (6) A covered refuse container shall be located in the outdoor pet dining area and shall be used exclusively to store all pet waste generated by the outdoor pet dining area.

**(E) Construction.**

- (1) The retail food establishment shall post signs at the entrance of ~~the outdoor pet~~ dining areas stating the facility is pet dining friendly and has an outdoor pet dining area.
- (2) The retail food establishment shall post signs stating pets are only allowed in the outdoor pet dining area ~~only~~.
- (3) Outdoor pet dining areas shall have an outside entrance.
- (4) Pets shall be restricted to the outdoor pet dining area ~~only~~ and shall not be allowed in the retail food establishment.
- (5) All pets shall be restrained and under control of the owners.
- (6) No pets are allowed on a ~~chair~~, table, countertop, or any other ~~furnishings~~ food contact surfaces within the outdoor pet dining area.

**(F) Compliance.**

- (1) Retail food establishments that have pets on the premises and do not comply with this standard shall be cited for violations under Sections 2-403.11 and 6-501.115 as applicable.
- (2) This standard shall not apply to service animals in outdoor or indoor dining areas.

**~~9-4 Wild Mushroom Foraging~~ WILD MUSHROOM FORAGING**

Wild foraged mushrooms species must be individually inspected and found to be safe by an approved mushroom identification expert that:

- (A) Has met the requirements of knowledge and passed an exam given by a 3rd party certifier that has been approved by the Department; and

(B) Will harvest only those mushrooms species listed below:

Pink Chanterelles (*Cantharellus cinnabarinus*)

Golden Chanterelles (*Cantharellus cibarius*, *C. lateritius*, *C. Appalachianensis*)

Yellow Morel (*Morchella esculenta*)

Tulip Morel (*Morchella deliciosa*)

Black morel (*Morchella elata*)

Black Trumpet (*Craterellus fallax*)

Lobster (*Hypomyces lactifluorum*)

Wood Ears (*Auricula auricularia*, *A. Fuscosuccinea*)

Chicken of the Woods (*Laetiporus sulphureus*, *L. cincinnatus*, *L. perscinus*)

~~Beafsteak~~ Beefsteak (*Fistulina hepatica*)

Hedgehog (*Hydnum repandum*)

Lions Mane or Pom Pom (*Hericium erinaceus*, *H. ramosum*)

White Oyster Mushroom (*Pleurotus ostreatus*, *P. pulmonarius*, *P. populinus*, *P. floridanus*)

Cauliflower (*Sparassis crispa*, *S. herbstii*, *S. spathulata*)

Maitake (*Grifola frondosa*)

Blewits (*Clitocybe nuda*)

Honey (*Armillaria ostoyae*, *A. mellea*, *A. tabescens*)

Blue Milky (*Lactarius indigo*)

Golden Milkies (*Lactarius corrugis*, *L. volemus*)

Pecan Truffle (*Tuber lyonii*).

## **9-5 ~~Shared Use Operations~~ SHARED USE OPERATIONS**

This standard shall apply to retail food establishments designed and operated for use by multiple permit holders.

### **(A) Definitions.**

(1) **Shared use operation** is a facility designed for multiple and individually permitted retail food establishment(s) or other food processing plant(s) operating at different times using the same area

and equipment for cooking, processing, or preparing food that is provided to the consumer. The purpose of a shared use operation is to provide farmers, caterers, gourmet food producers, and others interested in the production of food items, a facility to prepare food products. ~~The A~~ shared use operation provides a licensed South Carolina Department of Agriculture or permitted retail food establishment the equipment and individual spaces necessary to prepare, package, store, and label their products. A shared use operation may also serve as a commissary for mobile food establishments provided it meets the requirements as per section 9-1, *Mobile Food*. retail food establishments that prepare and serve food to highly susceptible populations such as those operated by health care facilities that are regulated by the Department shall not be approved as a shared use operation.

(2) **Facilitator** means the person responsible for all facility structural requirements, equipment, maintenance, and scheduling of a shared use operation.

### **(B) General.**

(1) The facilitator shall obtain a retail food establishment permit and shall be responsible for the facility and equipment maintenance, utilities, refuse removal, and other common use services.

~~(1)~~ A shared use operation and the associated retail food establishments shall comply with all applicable provisions of this regulation, except as outlined in this standard.

~~(2)~~ The Department may prohibit the distribution of certain time/temperature control for safety food, and may modify specific requirements for physical facilities when, in the opinion of the Department, no health hazard will result.

### **(C) Permits, Compliance**

(1) Facilitator.

~~(a) The facilitator shall obtain a retail food establishment permit and shall be responsible for the facility and equipment maintenance, utilities, garbage service and other common use services.~~ The facilitator shall provide to the Department the number of associated retail food establishments and/or licensed SCDA operators that the shared use kitchen can accommodate. The shared use operation shall not exceed this number of operators without first notifying the Department.

(b) The facilitator shall maintain a schedule of the associated retail food establishment(s) days and hours of operation. This information shall be provided to the Department weekly for purposes of inspections and foodborne outbreak or complaint investigations.

(c) Only those retail food establishment(s) that are scheduled to use the kitchen for a particular day and time will be allowed in the shared areas.

(d) The facilitator shall ensure that deliveries that are received are from approved sources and are placed into appropriate storage locations such that they are maintained at the required temperatures, protected from contamination, unadulterated and accurately presented.

(e) The facilitator shall provide notice to the Department prior to the addition or deletion of associated retail food establishments.

(2) Associated retail food establishments.

(a) Each proposed operator shall obtain a retail food establishment permit.

(b) Each associated retail food establishment shall be responsible for its own operation and shall be required to comply with all applicable sections of the regulation.

(c) Each associated retail food establishments shall have a secured dry storage area(s), and designated space in walk-in coolers and freezers for items exclusive to their operation.

#### **(D) Compliance.**

(13) No person shall operate a shared use operation that does not have a permit issued by the Department pursuant to 8-301.11.

(24) Only a person who complies with the requirements of this regulation and this standard shall be entitled to receive and retain such a permit.

(35) Any person who proposes to operate a shared use operation must apply to the Department for a permit on the application form provided by the Department pursuant to 8-302.

(46) The Department shall be notified of any changes to the shared use operation or associated retail food establishment, such as, but not limited to, operations, equipment, or menu, in accordance with 8-304.11.

### **9-6 Immediate Outdoor Cooking IMMEDIATE OUTDOOR COOKING**

This standard shall apply to retail food establishments that provide food by outdoor cooking, grilling, or roasting of the food on their premises.

#### **(A) Definition.**

**Immediate outdoor cooking (IOC)** is the outdoor cooking, grilling, or roasting of food on the physical premises of a permitted retail food establishment. Immediate outdoor cooking activities shall not be associated with a mobile food unit, mobile food pushcart, farmer's market, or seasonal series.

#### **(B) General.**

(1) A retail food establishment that conducts IOC shall comply with all applicable provisions of this regulation, except as outlined in this standard.

(2) The Department may prohibit the distribution of certain time/temperature control for safety food, and may modify specific requirements for physical facilities when, in the opinion of the Department, no health hazard will result.

(3) The retail food establishment shall be in operation at all times during any IOC activities.

(4) The retail food establishment is solely responsible for all IOC provisions, including, but not limited to, employees, person in charge, food supplies, and preparations.

(5) The Department must approve the location that is to be considered the IOC area.

(6) The Department may have additional requirements due to environmental conditions that may pose a risk for contamination of food products. Under such conditions, the Department may limit or cease the use of the outdoor cooking and service areas.

**(C) Employees.**

Food employees shall not contact exposed, ready-to-eat-food with their bare hands and shall use suitable utensils such as deli tissue, spatulas, tongs, single-use gloves, or dispensing utensils.

**(D) Food.**

(1) All food preparation shall be completed inside the permitted retail food establishment.

(2) All food items shall be protected from contamination during transportation, storage, cooking, display, and service.

(3) All food employees shall prepare, hold, and serve food according to all applicable sections of Chapter 3, *Food*

(4) IOC shall have at least one temperature measuring device for checking temperatures of food that meets the following requirements:

~~(a) Scaled 0 to 220 degrees F (-18 to 104 degrees C); and~~

~~(b) Able to be calibrated; and~~

~~(c) Appropriate for the food density being checked.~~

(5) Leftover portions of food cooked during IOC shall be discarded immediately. No food shall be stored for future service.

**(E) Service.**

(1) Equipment used for IOC shall be limited to grills and steam pots.

(2) The Department shall authorize IOC operations based on the following:

(a) The permitted retail food establishment must be of sufficient size and capability to support the same operations inside as well as IOC.

(b) The same or similar size or type of equipment used for cooking inside the permitted retail food establishment may be authorized for IOC.

(c) The same or similar type foods that are cooked inside the permitted retail food establishment may be authorized for IOC.

(3) Only the cooking and immediate service of food will be allowed during IOC operations; except that the serving of displayed food in the immediate cooking area must be completed within four (4) hours for any single function or activity.

(4) Food shall be kept covered, except during times of continuous serving or display.

(5) Covers or lids may be removed only for monitoring, stirring, or adding additional ingredients.

(6) Condiments must be dispensed in individual single-service type packets, pump dispensers, squeeze bottles, shakers, or similar dispensers which minimize contamination of food items by food employees, patrons, vermin, environmental conditions, or other sources.

(7) Equipment and utensils shall be adequate in number to conduct the IOC activities.

(8) In-use wiping cloths shall be stored in a clean solution of an approved sanitizer.

(9) The IOC area shall be effectively separated from the public.

### **(F) Construction.**

(1) Floors shall be constructed of concrete, asphalt, tight wood, or other similarly cleanable material and shall be kept clean and in good repair.

(2) Light bulbs and fluorescent tubes shall be shielded, coated, or otherwise shatter-resistant and provide 20-foot candles of illumination.

(3) All IOC equipment, including tables, shall be safe, corrosion resistant, nonabsorbent, smooth, easily cleanable, durable, and free of seams and difficult to clean areas.

(4) Warewashing is not permitted outside. All utensils/equipment used in outdoor cooking/serving of food shall be returned to the permitted retail food establishment for proper cleaning; except that, in-place cleaning may be allowed for grills and similar equipment.

### **(G) Handwashing Sinks.**

If IOC exceeds four (4) times per calendar year, the following handwashing sink requirement shall be met:

(1) A permanently installed exterior handwashing sink shall be provided pursuant to 5-202.12, 5-203.11 and 5-204.11.

(2) If using a portable handwashing sink, it shall ~~meet~~ have a minimum five (5) gallon potable water-dispensing tank and a minimum seven point five (7.5) gallon waste water holding tank.

(3) The handwashing sink shall be provided with soap and disposable paper towels.

(4) When a permanently installed exterior handwashing sink is not required, a container of water with a spigot, soap, disposable towels and a catch bucket shall be provided.

(5) Gloves and/or hand sanitizers shall not be allowed as a substitute for handwashing facilities.

### **(H) Authorization.**

(1) No retail food establishment shall conduct IOC operations that does not have an authorization issued by the Department.

(2) Any retail food establishment that operates or proposes to conduct IOC operations must apply to the Department for an authorization thru the application process.

(3) Only a retail food establishment who complies with the requirements of this regulation and this standard shall be entitled to, receive and retain such an authorization.

(4) Once IOC has been authorized, the retail food establishment shall notify the Department of any changes to the authorized IOC operation, such as, but not limited to, operations, procedures, menus, or changes in the retail food establishment in accordance with 8-304.11(B).

## **9-7 Barbecue Pit And Pit-Cooking Room Construction BARBECUE PIT AND PIT-COOKING ROOM CONSTRUCTION**

This standard shall apply to the construction and operation of a barbeque pit or smokehouse room as part of a retail food establishment.

### **(A) Definition.**

**Barbecue** defined as a single process method of cooking by which meat, poultry, or fish (either whole or in pieces) is covered and slow cooked in a pit or on a spit, using an indirect or direct heat source.

### **(B) General.**

Barbecue pit rooms shall be located on the physical premises of the permitted retail food establishment.

### **(C) Employees.**

(1) Food employees shall not contact exposed, ready-to-eat-food with their bare hands and shall use suitable utensils such as deli tissue, spatulas, tongs, single-use gloves, or dispensing utensils.

(2) Personal clothing and belongings shall be stored in a designated place away from food preparation, food service, dry storage areas, utensil and single-service article storage, and utensil washing areas.

### **(D) Food.**

(1) All food items shall be protected from contamination during transportation, storage, cooking, display, and service.

(2) All food employees shall prepare, hold, and serve food according to all applicable sections of Chapter 3, *Food*

(3) Pit rooms shall have at least one temperature measuring device for checking temperatures of food that meets the following requirements:

(a) ~~Scaled 0 to 220 degrees F (-18 to 104 degrees C); and~~

(~~b~~a) Able to be calibrated; and

(~~e~~b) Appropriate for the food density being checked.

(4) Adequate refrigeration shall be provided to support the cooking activity conducted in the pit room at the permitted retail food establishment.

### **(E) Pit-Cooking Room Restrictions.**

(1) Pit-cooking rooms built according to these minimum construction requirements shall be restricted to barbecue cooking equipment and the single process of cooking.

(2) No additional food preparation or processing activities shall be permitted in the pit room unless there is full compliance with all construction requirements pursuant to Chapter 6 of this regulation.

### **(F) Construction.**

(1) All sides and the ceiling of the pit room shall be completely enclosed.

(2) Screening may be used above wainscot height, four (4) feet on walls, and must be at least sixteen (16) mesh per inch.

(3) All outside openings shall be protected against insects by tight-fitting, self-closing doors, closed windows, screening, approved fly fans, or other means.

(4) Canvas flaps or other effective devices may be required to protect against blowing contamination.

(5) A large tight fitting garage door may be allowed without a self-closer, but shall remain closed during cooking operations.

(6) Floors of pit-cooking rooms, excluding pit floors, shall be constructed of smooth, durable materials such as sealed concrete, quarry tile, vinyl floor covering, or other approved material.

(7) Floors shall be maintained in good repair.

(8) Floors approved for water flushing, such as quarry tile or sealed concrete, shall be graded to floor drains, and shall have junctures between walls and floors sealed.

(9) Interior walls shall have smooth, easily cleanable, and washable surfaces to at least wainscot height (4 feet).

(10) If screening is used above wainscot, studs and other exposed bracing shall be sealed or painted.

(11) Concrete blocks or other masonry products used for wall construction shall be trowelled, skim-coated, or receive sufficient coats of full strength block filler to render a smooth surface prior to the application of a washable paint.

(12) Ceilings shall be finished to provide a smooth, nonabsorbent, and easily cleanable surface.

(13) Trusses and rafters shall not be exposed.

(14) Ceiling joists shall be properly sealed.



(15) Pit-cooking rooms shall be ventilated and kept reasonably free of excessive heat, vapors, smoke, and fumes by ventilating the pit itself or by ventilating the room. Pit ventilation can be achieved by a chimney or duct using dampers, pit doors, or other devices to control airflow. Pit-cooking rooms may be ventilated by a cathedral ceiling with screened roof-ridge vents, mechanical exhaust fans, or other effective methods approved by the Department, when pits are not directly vented to the outside.

(16) At least twenty (20) foot-candles of light shall be provided at all working surfaces, including the handwashing sink.

### **(G) Cooking Pit and Cooker Construction.**

(1) Cooking pit floors may consist of a solid base of compacted clay with a top layer of clean sand to absorb grease drippings. Sand shall be replaced as necessary to maintain a safe and sanitary condition.

(2) Pit floors may also be constructed of concrete, firebrick, or other material that can be cleaned and maintained.

(3) Cooking pit walls (exterior sides only) shall be smooth, easily cleanable, and washable.

(4) Concrete blocks or other masonry products used for pit construction shall be trowelled, skim coated, or receive sufficient coats of full strength block filler applied to the exterior wall prior to the application of a washable paint.

(5) Pit grills, grates, and other supports shall be constructed of smooth, easily cleanable, nonabsorbent, ~~and~~ non-toxic material, and shall be in sections that are easily removable for cleaning.

(6) Hog wire, chicken wire, hardware cloth, and similar materials, that are not galvanized or have welded joints, are permitted for single-use only and shall be discarded after each cooking period. Expanded metal and cast iron grating are recommended materials that can be cleaned and maintained.

(7) Pit covers shall be single-use or shall be constructed of a smooth, easily cleanable, nonabsorbent, and non-toxic material.

(8) The use of cookers and mobile cookers in lieu of a barbecue pit shall require the prior approval of the Department. These units shall be located in the pit room.

### **(H) Handwashing Sinks.**

(1) Handwashing sinks shall be provided pursuant to 5-202.12, 5-203.11, and 5-204.11.

(2) The handwashing sink shall be provided with soap and disposable paper towels.

(3) Gloves and/or hand sanitizers shall not be allowed as a substitute for handwashing facilities.

### **(I) Authorization.**

(1) No retail food establishment shall operate a barbecue pit that does not have an authorization issued by the Department.

(2) Any retail food establishment that operates or proposes to operate a barbecue pit must apply to the Department for an authorization through the application process.

(3) The following additional documentation shall be submitted as part of the application process:

(a) Information about food prepared in the barbecue pit room; and

(b) Any other information requested by the Department.

(4) Only a retail food establishment that complies with the requirements of this regulation and this standard shall be entitled to receive and retain such an authorization.

(5) Once a barbecue pit has been authorized, the Department shall be notified of any changes to the barbecue pit, such as, but not limited to, operational changes, menu changes, or changes in the barbecue pit in accordance with 8-304.11(B).

### **9-8 Temporary Food Service Establishments TEMPORARY FOOD SERVICE ESTABLISHMENTS**

This standard shall apply to the construction and operation of a temporary food establishment.

#### **(A) Definitions.**

A **temporary food service establishment** is an establishment that may be authorized by the Department to operate at a fixed location for a period of time not to exceed fourteen (14) consecutive days in connection with a fair, carnival, circus, trade show, movie or filming location, golf or other national sporting events, and other transitory gatherings organized by the community. This standard also applies to retail food service establishments that operate in an area affected by a natural or man-made disaster and where a state of emergency or a public health emergency has been declared.

#### **(B) General.**

(1) Temporary food service establishments shall comply with all applicable sections of this regulation except as outlined in this standard.

(2) The Department may prohibit the distribution of certain time/temperature control for safety food, and may modify specific requirements for physical facilities when, in the opinion of the Department, no health hazard will result.

#### **(C) Employees.**

(1) Food vendors and/or employees shall not contact exposed, ready-to-eat-food with their bare hands and shall use suitable utensils such as deli tissue, spatulas, tongs, single-use gloves, or dispensing utensils.

(2) Personal clothing and belongings shall be stored in a designated place away from food preparation, food service, dry storage areas, utensil and single-use article storage, and utensil washing areas.

#### **(D) Food.**

- (1) All food/ice shall be obtained from sources approved by the Department.
- (2) All food items shall be protected from contamination during transportation, storage, cooking, display, and service.
- (3) All food vendors shall prepare, hold, and serve food according to all applicable sections of Chapter 3, *Food*
- (4) All time/temperature for safety food cooked offsite shall be provided by a retail food establishment or mobile food establishment permitted under this regulation.
- (5) Time/temperature for safety foods that have been cooked or are in hot holding at any point during the daily operating hours shall be discarded at the end of the day.
- (6) Condiments shall be protected from contamination by being kept in dispensers that are designed to provide protection or offered in individual packages.
- (7) Cakes, breads, and cookies that are not made at a permitted retail food establishment may be offered for sale only if they are not a time/temperature for safety food.
- (8) Ice shall be obtained in closed single-service bags or approved covered containers and shall be protected from contamination. Ice used as a coolant for foods shall not be used for edible ice.
- (9) Each temporary food service establishment shall have at least one temperature measuring device for checking temperatures of food that meets the following requirements:
  - ~~(a) Sealed 0 to 220 degrees F ( - 18 to 104 degrees C); and~~
  - ~~(b)~~ (a) Able to be calibrated; and
  - (e) (b) Appropriate for the food density being checked.

**(E) Service.**

- (1) During operations, food shall be stored, cooked, displayed, and served from the temporary food service establishment only.
- (2) Customer self-service of unpackaged time/temperature control for safety foods is prohibited.
- (3) Temporary food service establishments shall provide only single-service articles for use by the consumer.
- (4) Condiments shall be protected from contamination by being kept in dispensers that are designed to provide protection or offered in individual packages.
- (5) In use wiping cloths must be stored in clean solution of an approved sanitizer.
- (6) A test kit that accurately measures the parts per million concentration of an approved sanitizer shall be accessible and used.
- (7) Food shall be kept covered except during times of continuous serving or display.

(8) Covers or lids may be removed only for monitoring, stirring, or adding additional ingredients.

**(F) Construction.**

(1) Floors shall be constructed of concrete, asphalt, tight wood, or other similar cleanable material.

(2) Floors shall be kept clean and in good repair.

(3) Walls shall be constructed of a solid, easily cleanable material.

(4) Screening may be used above wainscot height, four (4) feet, on walls and must be at least sixteen (16) mesh per inch.

(5) Studs and joists may be exposed, provided they are sealed.

(6) Ceilings shall be constructed of a solid, easily cleanable material.

(7) Exposed ceiling joists and rafters may be allowed, provided they are sealed.

(8) Light bulbs and fluorescent tubes shall be shielded, coated, or otherwise shatter-resistant and provide at least twenty (20) foot candles of illumination.

(9) All outside openings shall be protected against insects by tight-fitting, self-closing doors, closed windows, screening, approved air curtains, or other means.

(10) Canvas flaps or other effective devices may be required to protect against blowing contamination where screening is used.

(11) Counter-service openings shall be equipped with approved air curtains, self-closing windows, or free-falling windows or screens that must be at least sixteen (16) mesh per inch. Where air curtains are used, the size of the openings shall be limited so that the fans effectively prevent the entrance of flying insects.

(12) A temporary food establishment shall be equipped with a warewashing sink with at least three (3) compartments large enough to accommodate two thirds of the largest utensil. This requirement shall not apply to temporary food establishments engaged only in the dispensing of prepackaged food.

(13) The warewashing sink shall be supplied with hot ~~and~~ cold water under pressure, equipped with a mixing faucet that is capable of servicing all sink compartments.

(14) Adequate refrigeration shall be provided.

(15) A temperature measuring device shall be provided for each refrigeration unit.

(16) Equipment shall be installed in a manner that allows it to be maintained in a sanitary condition.

(17) Ice and beverages may be dispensed in the serving area if protected from contamination. This area must be sheltered but is not required to be screened or enclosed.

### **(G) Handwashing Sinks.**

(1) All temporary food service establishments shall have a separate handwashing sink, equipped with hot and cold water under pressure through a mixing valve or combination faucet.

(2) The handwashing sink shall be separated from food and food contact surfaces by either a splashguard or a distance of at least twelve (12) inches.

(3) Soap and disposable paper towels must be provided and be adjacent to the handwashing sink.

(4) Gloves and/or hand sanitizers shall not be allowed as a substitute for handwashing facilities.

### **(H) Water system.**

(1) Drinking water hoses shall be made from food grade materials and shall be a different color from hoses used for sewage.

(2) Drinking water hoses shall be capped or covered when not in use and shall be stored separately from sewage hoses.

(3) When attached to a drinking water system, the temporary food service establishment shall be equipped with an approved ~~backsiphonage~~backflow prevention device.

(4) Connections to the drinking water and sewage tanks shall be different types or sizes to eliminate contamination of the drinking water supply.

(5) Sewage and drinking water hose connections shall not be interchangeable.

(6) Water heaters with sufficient capacity shall be provided in facilities that prepare and serve time/temperature for safety food.

### **(I) Sewage Retention.**

(1) Sewage that is not directly discharged into an approved sewage system shall be kept in closed containers adequate in number and capacity to prevent spillage and must be discharged into an approved sewage disposal system as often as needed.

(2) All sewage lines shall be connected to sewage tanks with watertight seals.

(3) Used cooking oil shall be disposed of in an approved manner.

(4) Adequate and approved toilet facilities shall be provided.

(5) Adequate trash cans and other sanitary facilities, as deemed necessary by the Department, shall be provided to support the temporary food service establishments operating at the event.

### **(J) Specific Exemptions.**

(1) Temporary food service establishments are exempt from the requirements for training certification in 2-102.12(B).

(2) Temporary food service establishments that provide foods pursuant to 8-301.12(A)(11),(12),(19) and (20) of this regulation are exempt from the requirements of this standard.

~~(3) Mechanical ventilation of cooking equipment is not required.~~

**(K) Authorization.**

(1) No person, retail food establishment, or mobile food unit may serve time/temperature for safety food at a temporary food service establishment unless the sponsoring entity obtains authorization from the Department.

(2) The sponsoring entity of an event where temporary food service establishments will operate shall appoint an Event Coordinator as a point of contact.

(3) Any sponsoring entity that operates or proposes to operate an event where temporary food service establishments will operate shall apply for authorization on the form provided by the Department prior to commencement of the event. The following information shall be submitted with the application:

(a) Event Coordinator name and contact information; ~~and~~

(b) The dates of the fourteen (14) consecutive days of operation; ~~and~~

(c) A list of temporary food service establishments, with contact information, that will operate at the event; and

(d) The time that all temporary food service establishments are required to be ready for operation.

(4) Each temporary food service establishment shall be authorized by the Department prior to serving food to the public at the event.

(5) The Department may require a sponsoring entity or a temporary food service establishment to submit information sufficient to determine if the definition and requirements of this standard or regulation are met. This information may include, but is not limited to, information defining the fair, carnival, circus, or organized event, event schedule(s), hours of food vendor operations, vendor list and foods specific to those vendors, and vendor contact information.

(6) All food vendors shall meet the requirements for temporary food service establishment.

(7) Food vendors shall not be allowed to operate under the requirements of Sections ~~9-109, Community Festivals, Special Promotions 9-121, South Carolina Farmers Markets and Seasonal Series~~ Retail Food Establishment - South Carolina Farmers Markets, Seasonal Series Remote Service of this regulation.

(8) When the Department determines that a sponsoring entity or a temporary food service establishment has violated applicable provisions of this standard or regulation, the Department may issue a written notice directing any or all temporary food service establishments to cease operations until the violations are corrected as determined by the Department.

(9) Any temporary food service establishment that proposes to operate at one event and location for more than fourteen (14) days, either by remaining in operation for additional consecutive days, or by reopening after a short period of closure, shall comply with the requirements for, and be permitted as, a retail food establishment or a mobile food establishment.

(10) If a retail food service establishment is operating as a temporary food service establishment in an area affected by a natural or man-made disaster after a state of emergency or a public health emergency has been declared, it may be allowed to exceed fourteen (14) consecutive days of operation if approved by the Department.

## **9-9 ~~Community Festivals~~ COMMUNITY FESTIVALS**

This standard shall apply to the service of food and the requirements of food vendors at community festivals.

### **(A) Definitions.**

**Community festivals** defined as events sponsored by a community group, city/county/state organization, as a community celebration, that are generally theme related, and have multiple food vendors recruited to provide food to the public for a time period not to exceed three (3) consecutive days or no more than seventy-two (72) continuous hours. Each community festival is unique and will not be held more frequently than annually, although a sponsoring organization or group might have multiple but differently themed community festivals in a year.

### **(B) General.**

(1) Community festival food vendors shall comply with all applicable sections of this regulation except as outlined in this standard.

(2) The Department may prohibit the distribution of certain time/temperature control for safety food, and may modify specific requirements for physical facilities when, in the opinion of the Department, no health hazard will result.

### **(C) Employees.**

(1) Food vendor employees shall not contact exposed, ready-to-eat-food with their bare hands and shall use suitable utensils such as deli tissue, spatulas, tongs, single-use gloves, or dispensing utensils.

(2) Personal clothing and belongings shall be stored in a designated place away from food preparation, food service, dry storage areas, utensils, and single-use article storage, and utensil washing areas.

### **(D) Food.**

(1) All food/ice shall be obtained from sources approved by the Department.

(2) All food items must be protected from contamination during transportation, storage, cooking, display, and service.

(3) All food vendors shall prepare, hold, and serve food according to all applicable sections of Chapter 3, *Food*

- (4) Time/temperature for safety foods, such as raw meat products, shall be ready to be cooked.
- (5) All time/temperature for safety food fully prepared or cooked offsite shall be provided by a retail food establishment or mobile food establishment permitted under the regulation.
- (6) Only quantities of meat, such as barbecue, may be pulled, chopped, or cut for same day service in the food vendor's preparation area.
- (7) No mechanical chopping equipment will be allowed in unenclosed preparation areas.
- (8) Time/temperature for safety foods that have been cooked or in hot holding at any point during the daily operating hours shall be discarded at the end of the day.
- (9) Condiments shall be protected from contamination by being kept in dispensers that are designed to provide protection or offered in individual packages.
- (10) Cakes, breads, and cookies that are not made at a permitted retail food establishment may be offered for sale only if they are not a time/temperature for safety food.
- (11) Ice shall be obtained in closed single-service bags or approved covered containers and shall be protected from contamination. Ice used as a coolant for foods shall not be used for edible ice.
- (12) Each community festival food vendor shall have at least one temperature measuring device for checking temperatures of food that meets the following requirements:
  - ~~(a) Sealed 0 to 220 degrees F ( - 18 to 104 degrees C); and~~
  - ~~(b)~~ (a) Able to be calibrated; and
  - ~~(c)~~ (b) Appropriate for the food density being checked.
- ~~(13) Food shall be kept covered except during times of continuous serving or display.~~
- ~~(14) Covers or lids may be removed only for monitoring, stirring, or adding additional ingredients.~~

### **(E) Construction.**

- (1) Food preparation areas shall have overhead protection and adequate barriers (e.g., tables or equipment) to prevent the access to the area by the public.
- (2) Equipment shall arrive clean and ready to use.
- (3) Utensils and single use articles shall be clean, protected during storage, and in sufficient quantities to conduct the activity.

### **(F) Handwashing Sinks.**

- (1) When a handwashing sink is not available, a container of water with a spigot, soap, disposable towels, and a catch bucket shall be provided.



- (2) Gloves and/or hand sanitizers shall not be allowed as a substitute for handwashing facilities.

### **(G) Water system.**

- (1) Drinking water hoses shall be made from food grade materials and shall be a different color from hoses used for sewage.
- (2) Drinking water hoses shall be capped or covered when not in use and shall be stored separately from sewage hoses.
- (3) When attached to a drinking water system, the hose shall be equipped with an approved ~~backsiphonage~~ backflow prevention device.

### **(H) Sewage Retention.**

- (1) Sewage that is not directly discharged into an approved sewage system shall be kept in closed containers with adequate capacity or adequate in number to prevent spillage and must be discharged into an approved sewage disposal system as often as needed.
- (2) All sewage lines shall be connected to sewage tanks with watertight seals.
- (3) Used cooking oil shall be disposed of in an approved manner.
- (4) Adequate toilet facilities shall be provided.
- (5) Adequate trash cans, and other sanitary facilities, as deemed necessary by the Department, shall be provided to support the community festival food vendors.

### **(I) Specific Exemptions.**

- (1) Community festival food vendors are exempt from the requirements for training certification in 2-102.20.
- (2) Community festival food vendors that provide food pursuant to 8-301.12(A)(11),(12),(19) and (20) are exempt from the requirements of this standard.
- (3) Hot water requirements are waived for food vendors at community festivals.
- (4) ~~Mechanical ventilation of cooking equipment is not required.~~

### **(J) Authorization.**

- (1) No person, retail food establishment, or mobile food unit may serve time/temperature control for safety food at a community festival unless the sponsoring entity obtains authorization from the Department.
- (2) The sponsoring entity of a community festivals shall appoint an Event Coordinator as a point of contact.
- (3) Any sponsoring entity that operates or proposes to operate a community festival where time/temperature for safety food will be served shall apply for authorization on the form provided by the

Department prior to commencement of the festival. The following information must be submitted with the application:

- (a) The Event Coordinator's name and contact information; ~~and~~
  - (b) The dates of the seventy-two (72) continuous hour period in which all food vendors will be in operation; ~~and~~
  - (c) A list of food vendors, with contact information, that will operate at the event; and
  - (d) The time that all food vendors are required to be ready for operation.
- (4) Each community festival food vendor shall be authorized by the Department prior to serving food to the public at the festival.
- (5) The Department may require a sponsoring entity or a food vendor to submit information sufficient to determine if the definition and requirements of this standard or regulation are met. This information may include, but is not limited to, information defining the community group, city/county/state organization, event schedule(s), hours of food vendor operations, vendor list and foods specific to those vendors, and vendor contact information.
- (6) When the Department determines that a sponsoring entity or a food vendor has violated applicable provisions of this standard or regulation, the Department may issue a written notice directing any or all food vendors to cease operations until the violations are corrected as determined by the Department.

## **9-10 Special Promotions SPECIAL PROMOTIONS**

This standard shall apply to the service of food and the requirements of food vendors at special promotions.

**(A) Special promotions** defined as events sponsored by businesses or city/county organizations that may be authorized by the Department to prepare and dispense food for the purpose of promoting a product or service. Preparation and dispensing food at special promotions are limited to one (1) day in duration at four (4) separate times per year. Special promotions do not include regularly occurring sporting events, such as, but not limited to, school ballgames.

### **(B) General.**

(1) Food preparation and service areas shall comply with all applicable sections of this regulation except as outlined in this standard.

(2) The Department may prohibit the distribution of certain time/temperature control for safety foods, and may modify specific requirements for physical facilities when, in the opinion of the Department, no health hazard will result.

### **(C) Employees.**

(1) Food vendor employees shall not contact exposed, ready-to-eat-food with their bare hands and shall use suitable utensils such as deli tissue, spatulas, tongs, single-use gloves, or dispensing utensils.

(2) Personal clothing and belongings shall be stored in a designated place away from food preparation, food service, dry storage areas, utensil and single-use article storage, and utensil washing areas.

**(D) Food.**

(1) All food/ice shall be obtained from sources approved by the Department.

(2) All food items must be protected from contamination during transportation, storage, cooking, display, and service.

(3) All food vendors shall prepare, hold, and serve food according to all applicable sections of Chapter 3, *Food*

(4) Time/temperature for safety foods, such as raw meat products, shall be ready to be cooked.

(5) All time/temperature for safety food cooked offsite shall be provided by a retail food establishment or mobile food establishment permitted under this regulation.

(6) Condiments shall be protected from contamination by being kept in dispensers that are designed to provide protection or offered in individual packages.

(7) Cakes, breads, and cookies that are not made at a permitted retail food establishments may be offered for sale only if they are not a time/temperature for safety food.

(8) Ice shall be obtained in closed single-service bags or approved covered containers and shall be protected from contamination.

(9) Ice used as a coolant for foods shall not be used for edible ice.

(10) Each food vendor shall have at least one temperature measuring device for checking temperatures of food that meets the following requirements:

~~(a) Scaled 0 to 220 degrees F (-18 to 104 degrees C); and~~

~~(b)~~ Able to be calibrated; and

~~(c)~~ Appropriate for the food density being checked.

**(E) Construction.**

(1) Food preparation areas shall have overhead protection and adequate barriers (e.g., tables or equipment) to prevent the access to the area by the public.

(2) Equipment shall arrive clean and ready to use.

(3) Utensils and single-service articles shall be clean, protected during storage, and in sufficient quantities to conduct the activity.

**(F) Handwashing Sinks.**

(1) When a handwashing sink is not available, a container of water with a spigot, soap, disposable towels, and a catch bucket shall be provided.

(2) Gloves and/or hand sanitizers shall not be allowed as a substitute for handwashing facilities.

### **(G) Water system.**

(1) Drinking water hoses shall be made from food grade materials and shall be a different color from hoses used for sewage.

(2) Drinking water hoses shall be capped or covered when not in use and shall be stored separately from sewage hoses.

(3) When attached to a drinking water system, the hose shall be equipped with an approved backsiphonage/backflow prevention device.

### **(H) Sewage Retention.**

(1) Sewage that is not directly discharged into an approved sewage system shall be kept in closed containers with adequate capacity to prevent spillage and must be discharged into an approved sewage disposal system as often as needed.

(2) All sewage lines shall be connected to sewage tanks with watertight seals.

(3) Used cooking oil shall be disposed of in an approved manner.

### **(I) Specific Exemptions.**

(1) Special promotions are exempt from the requirements for training certification in 2-102.20.

(2) Special promotions that provide food pursuant to 8-301.12(A)(11),(12),(19) and (20) are exempt from the requirements of this standard.

(3) Hot water requirements are waived for special promotions.

~~(4) Mechanical ventilation of cooking equipment is not required.~~

~~(5) Toilet and service sink facilities are not required for special promotions.~~

### **(J) Authorization.**

(1) The Department may require a sponsoring entity to submit information sufficient to determine if a special promotion complies with this standard and regulation. This information may include, but is not limited to, information defining the businesses, or city/county organizations, event schedule(s), hours of food vendor operations, vendor list and foods specific to those vendors, and vendor contact information.

(2) When the Department determines that a sponsoring entity has violated applicable provisions of this standard or regulation, the Department may issue a written order directing the special promotion to cease operations.

## **9-11 South Carolina Farmers Market And Seasonal SERIES RETAIL FOOD ESTABLISHMENT - SOUTH CAROLINA FARMER'S MARKETS, SEASONAL SERIES, AND REMOTE SERVICE**

This standard shall apply to the service of food and the requirements of food vendors participating in SC Farmers Markets and Seasonal Series, Remote Service Operations, or other events as approved by the Department.

### **(A) Definitions.**

(1) **Community-based farmers market** means a market sponsored by a community or governmental organization either having been Certified by the South Carolina Department of Agriculture as a SC Certified Farmer's Market or a farmers market that meets the definition of the Farmers Market Coalition which states, "A farmers market operates multiple times per year and is organized for the purpose of facilitating personal connections that create mutual benefits for local farmers, shoppers, and communities and implements rule or guidelines of operation that ensure that the farmers market consists principally of farms selling directly to the public products that the farms have produced."

(2) **Seasonal series** means a regularly occurring event sponsored by a community or governmental organization for promoting local business, culture, or other local specialties.

(3) **Remote service operation** permitted retail food establishment providing food to individual consumers at an indoor location by food employees of the retail establishment who maintain control of the food service.

### **(B) General.**

(1) Retail food establishments at a seasonal series or community-based farmers market or remote service site shall comply with all applicable sections of this regulation except as outlined in this standard.

(2) The Department may prohibit the distribution of certain time/temperature control for safety foods, and may modify specific requirements for physical facilities when, in the opinion of the Department, no health hazard will result.

(3) Permitted retail food establishments may be authorized by the Department to cook and serve food to the public at community farmers markets and/or seasonal series ~~only one~~ (1) two (2) days per week during one continuous period of time not to exceed six (6) hours.

(4) Community-based farmers market and seasonal series shall designate ~~one~~ the days of the week food vendors are allowed to operate.

(5) Roadside produce stands and flea markets are not defined as community-based farmers markets or seasonal series, and this standard shall not apply to those locations.

### **(C) Employees.**

(1) Retail food establishment employees shall not contact exposed, ready-to-eat-food with their bare hands and shall use suitable utensils such as deli tissue, spatulas, tongs, single-use gloves, or dispensing utensils.

(2) Personal clothing and belongings shall be stored in a designated place away from food preparation, food service, dry storage areas, utensils and single-use article storage, and utensil washing areas.

**(D) Food.**

(1) Preparation of bulk food, including washing, slicing, peeling, and cutting, shall occur at the permitted retail food establishment.

(2) All food items shall be protected from contamination during transportation, storage, cooking, display, and service.

(3) All food vendors shall prepare, hold, and serve food according to all applicable sections of Chapter 3, *Food*

(4) Time/temperature for safety foods that have been cooked or are in hot holding at any point during the daily operating hours shall be discarded at the end of the day.

(5) Condiments shall be protected from contamination by being kept in dispensers that are designed to provide protection or offered in individual packages.

(6) Ice shall be obtained from an approved source, in closed single-service bags or approved covered containers and shall be protected from contamination.

(7) Ice used as a coolant for foods shall not be used for edible ice.

(8) Each retail food establishment shall have at least one temperature measuring device for checking temperatures of food that meets the following requirements:

~~(a) Sealed 0 to 220 degrees F (-18 to 104 degrees C); and~~

~~(b)~~ Able to be calibrated; and

~~(c)~~ Appropriate for the food density being checked.

(9) Food shall be kept covered except during times of continuous serving or display.

(10) Covers or lids shall not be removed other than for monitoring, stirring, or adding additional ingredients.

**(E) Construction.**

(1) Food preparation areas shall be provided with overhead protection and have adequate barriers (e.g., tables or equipment) to prevent the access to the area by the public.

(2) Equipment and utensils shall arrive clean, ready to use, and in sufficient quantities to conduct the activity.

(3) Equipment and utensils shall only be cleaned at the permitted retail food establishment.

(4) Only single-service articles shall be provided for use by the consumer.

## **(F) Handwashing Sinks.**

~~(1) Exterior handwashing sinks shall be provided within twenty five (25) feet of all retail food establishment food vendors and shall be centrally located and easily accessible. Each food vendor shall have at least one (1) handwashing facility located at the individual vendor location that may be either:~~

~~(a) A portable handsink that provides water under pressure or~~

~~(b) A container of water with a spigot and catch bucket.~~

~~(2) Hot and cold water or tempered running water 100 degrees F (38 degrees C) under pressure shall be provided to all handwashing sinks as specified in 5-202.12. All handwashing facilities must have adequate water dispensing storage capacity to meet the demand for handwashing. The wastewater storage capacity must be larger than the water storage container.~~

~~(3) If using a portable handwashing sink, it shall have a minimum five (5) gallon portable water dispensing tank and a minimum seven point five (7.5) gallon sewage holding tank. Handwashing facilities must include soap and disposable towels.~~

(4) Gloves and/or hand sanitizers shall not be allowed as a substitute for handwashing facilities.

## **(G) Water System.**

(1) Drinking water hoses shall be made from food grade materials and shall be a different color from hoses used for sewage.

(2) Drinking water hoses shall be capped or covered when not in use and shall be stored separately from sewage hoses.

(3) When attached to a drinking water system, the hose shall be equipped with an approved backflow prevention device.

## **(H) Sewage Retention and Refuse Removal.**

(1) Sewage that is not directly discharged into an approved sewage system shall be kept in closed containers adequate in number and capacity to prevent spillage and must be discharged into an approved sewage disposal system as often as needed.

(2) All sewage lines shall be connected to sewage tanks with watertight seals.

(3) Used cooking oil shall be disposed of in an approved manner.

(4) Adequate toilet facilities shall be provided.

(5) Adequate trash cans, as deemed necessary by the Department, shall be provided to support the retail food establishment.

## **(I) Specific Exemptions.**

~~(1) Seasonal series or community-based farmers markets are exempt from the requirements for training certification in 2-102.20.~~

~~(2) Seasonal series or community-based farmers markets that provide foods pursuant to 8-301.12(A)(11),(12),(19) and (20) are exempt from authorization based on the requirements of this standard.~~

~~(3) Mechanical ventilation of cooking equipment is not required.~~

## **(J) Authorization.**

(1) No retail food establishment, or mobile food unit may serve time/temperature control for safety foods at a seasonal series or community-based farmers market unless the sponsoring entity obtains authorization from the Department. Pre-approval is not required for remote service operations.

(2) The sponsoring entity of a seasonal series or community-based farmers market shall appoint an Event Coordinator as a point of contact.

(3) Any sponsoring entity that operates or proposes to operate a seasonal series or community-based farmers market where time/temperature control for safety foods will be served by retail food establishments shall apply for authorization from the Department. The following information shall be submitted:

(a) The Event Coordinator name and contact information; ~~and~~

(b) The one day of the week and hours of operation for food service; and

(c) A list of retail food establishments, with contact information, that will operate at the event.

(4) Each retail food establishment at a seasonal series or community-based farmers market shall be authorized by the Department prior to serving food to the public at the event.

(5) The Department may require a sponsoring entity or a retail food establishment to submit information sufficient to determine if the definition and requirements of this standard or regulation are met. This information may include, but is not limited to, information defining the community group, governmental organization, SC Certified Farmer's Market certification, association to Farmers Market Coalition, event schedule(s), hours of food vendor operations, vendor list and foods specific to those vendors, and vendor contact information.

(6) When the Department determines that a sponsoring entity or a retail food establishment has violated applicable provisions of this standard or regulation, the Department may issue a written notice directing any or all retail food establishment vendors to cease operations until the violations are corrected as determined by the Department.

61-37. Retail Food Establishment Inspection Fees

~~61-37. RETAIL FOOD ESTABLISHMENT INSPECTION FEES~~

~~SECTION I. PURPOSE~~



~~The citizens of South Carolina and our visitors expect and are entitled to wholesome, sanitary and safe food, no matter whether it is purchased in a grocery store or prepared and purchased in a restaurant or similar facility. To this end, the Department of Health and Environmental Control has established and maintained a conscientious program of permitting, inspecting and evaluating all types of retail facilities that provide food. This direct service program is conducted primarily by public health professionals working in county health departments. Funding for the program comes from state appropriations and fees authorized by this regulation.~~

## ~~SECTION II. DEFINITIONS~~

~~The following definitions shall apply in the interpretation and enforcement of this Regulation.~~

~~A. DEPARTMENT—the South Carolina Department of Health and Environmental Control.~~

~~B. PERMIT—the license to operate a retail food establishment issued by the Department pursuant to *Regulation 61-25, Retail Food Establishments*~~

~~C. RETAIL FOOD ESTABLISHMENT—as defined in *R.61-25, Retail Food Establishments*~~

~~D. FOOD—any raw, cooked or processed edible substance, ice, beverage, or ingredient used or intended for use or for sale in whole or in part for human consumption.~~

## ~~SECTION III. FEES, EXEMPTIONS, AND PENALTIES~~

### ~~A. INITIAL INSPECTION FEE~~

~~The Department shall charge annual inspection fees for retail food establishments. Retail food establishments obtaining a permit for the first time shall be charged an initial inspection fee of \$60.00. The fee shall be paid prior to the issuance of the permit.~~

### ~~B. RENEWAL INSPECTION FEE~~

~~After the first year, renewal inspection fees shall be based on gross sales of food and food products for the facility's previous business year. The renewal fee shall be \$60 for the first \$250,000 of sales, and shall be increased by \$30 for each additional \$250,000, or portion thereof, in sales. The maximum fee shall be \$270.00. Owners of retail food establishments shall furnish previous business year sales information on request of the Department; this information shall be exempt from disclosure pursuant to the South Carolina Freedom of Information Act, S.C. Code Section 30-4-40(a)(2).~~

### ~~C. RENEWAL FEE PAYMENT AND PENALTIES~~

~~Annually, retail food establishments shall be notified that their renewal fee is due. Each retail food establishment shall determine and pay the amount of renewal fee that is appropriate for its retail sales of food. Payment shall be due thirty (30) days from the billing date. A penalty charge of \$25.00 shall be assessed for fees that are thirty (30) days past due. A second penalty charge of \$25.00 shall be assessed for fees that are sixty (60) days past due.~~

### ~~D. FACILITIES EXEMPT FROM FEES~~

~~The following retail food establishments shall be exempt from initial and renewal fees:~~

- ~~1. Retail food establishments that are operated by a public or private school (kindergarten through grade 12); or that are operated by a child care facility.~~
- ~~2. Retail food establishments operated by health care facilities that are regulated by the Department.~~
- ~~3. Retail food establishments that are operated by other state agencies or local governments that provide food for patients, clients or inmates.~~
- ~~4. Retail food establishments that are operated by non-profit organizations for the purpose of providing meals or food to needy persons at little or no cost; or for the purpose of raising money for a charitable cause.~~

~~A retail food establishment claiming exemption from fee charges shall certify annually to the Department that it meets one or more of the above criteria, and upon request, provide documentation supporting any such certification.~~

#### ~~SECTION IV. COMPLIANCE PROCEDURES~~

##### ~~A. PERMIT SUSPENSION~~

~~Retail food establishments that have not paid their renewal fee and late payment penalties after ninety (90) days from their original billing date shall have their permit suspended upon service of notice of suspension. The Department may reinstate a permit suspended for failure to pay renewal fees upon payment of the fees, penalties and a \$25.00 reinstatement fee. Suspension of a permit for failure to pay the required annual fee, plus applicable late charges, shall not constitute a contested case and shall not create a right to a hearing pursuant to the South Carolina Administrative Procedures Act.~~

##### ~~B. SERVICE OF NOTICE~~

~~A notice provided for in this regulation is properly served when it is delivered to the permit holder, or an employee; or when it is sent by mail to the address of the permit holder; or when it is delivered to an employee designated to be or actually in charge of the retail food establishment.~~

##### ~~C. ENFORCEMENT PROVISIONS~~

~~This regulation is issued under the authority of Section 44-4-140, 1976 Code of Laws of South Carolina and subsequent legislation, and shall be enforced by the Department.~~

#### ~~SECTION V. OTHER~~

##### ~~A. DESIGNATION OF USE~~

~~Funds derived from these fees shall be used only for the provision of services and accompanying expenses associated with Environmental Health programs.~~

##### ~~B. UNCONSTITUTIONALITY CLAUSE~~

~~Should any chapter, paragraph, sentence, clause, or phrase of this regulation be declared unconstitutional or invalid for any reason, the remainder of this regulation shall not be affected thereby. [Repealed].~~

## **ATTACHMENT B**

### **DEPARTMENT OF HEALTH AND ENVIRONMENTAL CONTROL**

#### **CHAPTER 61**

Statutory Authority: 1976 Code Section(s) 44-1-140(2), 44-1-150, and 44-1-180

#### **Notice of Drafting:**

The Department of Health and Environmental Control (“Department”) proposes amending R.61-25, Retail Food Establishments. The Department further proposes amending requirements of R.61-37, Retail Food Establishment Inspection Fees, and merging R.61-37 into R.61-25. This will entail repealing R.61-37 and adding its provisions, as amended, to R.61-25. This notice supersedes the Notice of Drafting to amend R.61-25 and repeal R. 61-37 that was published in the South Carolina State Register Volume 42, Issue 4 on April 27, 2018.

Interested persons may submit written comments to Sandra D. Craig, Director, Division of Food and Lead Risk Assessments, Bureau of Environmental Health Services, S.C. Department of Health and Environmental Control, 2600 Bull Street, Columbia, S.C. 29201, or by email at [craigsd@dhec.sc.gov](mailto:craigsd@dhec.sc.gov). To be considered, written comments must be received no later than 5:00 p.m. on September 24, 2018, the close of the drafting comment period.

#### **Synopsis:**

Currently, R.61-25 is based on the 2013 Federal Food and Drug Administration (“FDA”) Food Code (“Food Code”), which the FDA has revised and replaced with the 2017 Food Code. The Department proposes amending R.61-25 to incorporate much of the revisions appearing in the 2017 Food Code. Furthermore, the Department proposes to revise selected sections of Chapter 9 to reflect the current business models of the food service industry and input from the regulated community. The Department also proposes amending the fee scale currently appearing in R.61-37, and, in the interest of efficiency, moving the amended fee scale to R.61-25 and repealing R.61-37. The fee scale revision would also include a fee increase, as the Department has not updated the fees in approximately 18 years.

The Department also proposes making other changes as deemed necessary to improve the overall clarity, organization, and quality of the regulation. These changes may include, but are not limited to, stylistic changes, updates to definitions and exemptions, corrections for clarity, readability, grammar, punctuation, references, and codification, and overall improvement of the text of the regulation.

General Assembly review is required.





(x) ACTION/DECISION  
( ) INFORMATION

Date: October 11, 2018

To: S.C. Board of Health and Environmental Control

From: Bureau of Environmental Health Services

**Re: Notice of Proposed Regulation amending R.61-56, Onsite Wastewater Systems, and R.61-55, Septic Tank Site Evaluation Fees, R.61-56.1, License To Construct Or Clean Onsite Sewage Treatment And Self-Contained Toilets, R.61-56.2, Licensing Of Onsite Wastewater Master Contractors.**

## I. Introduction

The Bureau of Environmental Health Services (“Bureau”) proposes the attached Notice of Proposed Regulation amending R.61-56, *Onsite Wastewater Systems*. The Bureau further proposes amending requirements of R.61-55, *Septic Tank Site Evaluation Fees*, by merging R.61-55 into R.61-56. This will entail repealing R.61-55 and adding its provisions, as amended, to R.61-56. The Bureau further proposes amending requirements of R.61-56.1, *License to Construct or Clean Onsite Sewage Treatment and Disposal Systems and Self-Contained Toilets*, and R.61-56.2, *Licensing of Onsite Wastewater Master Contractors*, and merging R.61-56.1 and R.61-56.2 into R.61-56. This will entail repealing R.61-56.1 and R.61-56.2 and adding their provisions, as amended, to R.61-56. The Bureau proposes these amendments and repeals for publication in the October 26, 2018 *South Carolina State Register*. Legal authority resides in S.C. Code Sections 44-1-140(11), 44-1-150, 44-55-827, and 48-1-10 et seq., which enable the Department of Health and Environmental Control (“Department”) to promulgate regulations related to the disposal of sewage and establish fees. The Administrative Procedures Act, S.C. Code Section 1-23-120(A), requires General Assembly review of these amendments.

## II. Facts

1. The Bureau proposes amending the requirements of R.61-55, R.61-56, R.61-56.1, and R.61-56.2 to upgrade overall quality and practicality, improve clarity and consistency, reflect changes in design, construction, and installation of onsite wastewater system nomenclature and technology, separate the licensing of pumper/haulers and installers, clarify existing definitions, and add new definitions and standards for site and system requirements. The Bureau further proposes combining the regulations into a single regulation, R.61-56, through repeal of R.61-55, R.61-56.1 and R.61-56.2 in the interest of efficiency.
2. Proposed revisions to requirements of R.61-56 include improved organization of information, new and clarified definitions, improved and additional system design standards, and upgraded nomenclature and technology. Proposed revisions to requirements currently residing in R.61-56.1 will separate the licensing of pumper/haulers and installers and implement a new three-tiered licensing program for installers that includes new continuing education requirements and a new tiered licensing fee schedule with increased fees. Because R.61-56.1 and R.61-56.2 are being combined with R.61-56, previously separate enforcement provisions will also be consolidated in a single section for clarity and efficiency.
3. The Department also proposes a new schedule of site evaluation procedures and fees to offer an applicant additional options for obtaining a permit to construct an onsite wastewater treatment system (also known as a septic system). Currently, a single application process and fee applies to all permit applicants unless an engineered, or specialized, septic system is requested. The proposed revisions would expand

existing options and allow more streamlined permit processing by permitting an applicant to select from four available site evaluation procedures and fee levels. Under this tiered system, the existing, standard site evaluation procedures and fee would be supplemented by additional options for applicants to submit third-party soils work and/or pay increased fees, allowing for more streamlined and expedited permit processing. For those applicants for conventional systems wishing to pay the existing, standard Department site evaluation fee, they may continue to do so under the new proposed site evaluation and fee process. These proposed revisions will allow a greater number of contractors to self-inspect their system installations. These proposed revisions will also enable expedited site evaluations and a larger selection of Master Contractors while reducing the number of final inspections required from Department. Furthermore, the proposed revisions will clarify use of third-party soil evaluations to expedite the issuance of a permit.

4. The Department also proposes making other changes as deemed necessary, including stylistic changes for internal consistency, such as corrections for clarity in wording, references, grammar, outlining and codification, and other changes as necessary to improve the overall quality of the regulation.

5. The Department had a Notice of Drafting published in the April 27, 2018 *State Register*. The Department received no public comments by the May 28, 2018, close of the public comment period.

6. The Bureau held eighteen (18) separate meetings between August 2, 2017, and September 25, 2018, to solicit stakeholder input, including an open-invitation public meeting and individual interest group discussions. A total of three hundred and seven (307) stakeholders attended. The Bureau utilized the Department's website and agency calendar to advertise these meetings, as well as mailed invitation cards and emailed invitations to identified stakeholders. Favorable feedback was received from these meetings.

7. Appropriate Department staff conducted an internal review of the proposed amendments on August 20, 2018.

### III. Request for Approval

The Bureau respectfully requests the Board to grant approval of the attached Notice of Proposed Regulation for publication in the October 26, 2018, *State Register*.

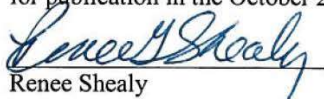

Renee Shealy  
Bureau Chief, Bureau of Environmental  
Health Services

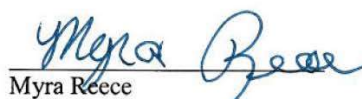

Myra Reece  
Director, Environmental Affairs

Attachments:

A. Notice of Proposed Regulation

B. Notice of Drafting published in the April 27, 2018, *State Register*

## **ATTACHMENT A**

### **STATE REGISTER NOTICE OF PROPOSED REGULATION FOR R. 61-56, *Onsite Wastewater Systems***

**October 11, 2018**

Document No. \_\_\_\_\_

#### **DEPARTMENT OF HEALTH AND ENVIRONMENTAL CONTROL CHAPTER 61**

Statutory Authority: 1976 Code Sections 44-1-140(11), 44-1-150, 44-55-827, and 48-1-10 et seq.

61-55. Septic Tank Site Evaluation Fees.

61-56. Onsite Wastewater Systems.

61-56.1. License to Construct or Clean Onsite Sewage Treatment and Self-Contained Toilets.

61-56.2. Licensing of Onsite Wastewater Systems Master Contractors.

#### **Preamble**

The Department of Health and Environmental Control (“Department”) proposes amending the requirements of R.61-55, R.61-56, R.61-56.1, and R.61-56.2 to reflect changes in design, construction, and installation of onsite wastewater system nomenclature and technology; clarify existing definitions; and add new definitions and standards for site and system requirements. Additional amendments are proposed to improve clarity and consistency, as well as upgrade the overall quality and practicality of the regulation. The Department further proposes combining these regulations into a single regulation, R.61-56, through the repeal of R.61-55, R.61-56.1 and R.61-56.2 in the interest of efficiency.

Proposed revisions to requirements of R.61-56 include improved organization of information, new and clarified definitions, improved system design standards, and upgraded nomenclature and technology. Proposed revisions to requirements currently residing in R.61-56.1 and R.61-56.2 will separate the licensing of pumper/haulers and installers and implement a new three-tiered licensing program for installers that includes new continuing education requirements and a new tiered licensing fee schedule with increased fees. Because R.61-56.1 and R.61-56.2 are being combined with R.61-56, previously separate enforcement provisions will also be consolidated in a single section for clarity and efficiency.

The Department also proposes a new schedule of site evaluation procedures and fees to offer an applicant additional options for obtaining a permit to construct an onsite wastewater treatment system (also known as a septic system). Currently, a single application process and fee applies to all permit applicants unless a specialized (also known as engineered) septic system is requested. The proposed revisions would expand existing options and allow more streamlined permit processing by permitting an applicant to select from four available site evaluation procedures and fee levels. Under this proposed schedule, the existing, standard site evaluation procedures and fee would be supplemented by additional options for applicants to submit third-party soils work and/or pay increased fees, allowing for more streamlined and expedited permit processing. For those applicants seeking conventional systems wishing to pay the existing, standard Department site evaluation fee, they may continue to do so under the new proposed site evaluation and fee schedule.

The Department also proposes making other changes as deemed necessary, including stylistic changes for internal consistency, such as corrections for clarity in wording, references, grammar, outlining and codification, and other changes as necessary to improve the overall quality of the regulation.



General Assembly review is required.

The Department had a Notice of Drafting published in the April 27, 2018, South Carolina State Register.

Section-by-Section Discussion of Proposed Amendments and Repeals:

**R.61-55**

Repealing R.61-55 and combining it, as amended, with R.61-56 to streamline processes.

**R.61-56**

Added: Statutory Authority 44-55-827.

Amended text throughout to correct capitalization, punctuation, spelling, formatting, and grammatical errors. Also amended “gallons per day” to the abbreviation “gpd” except for one instance. For brevity and space, these modifications are not listed.

**Table of Contents**

Table of Contents. Amended section titles, added new sections, and renumbered sections to reflect amendments made in text.

Added: Wording “Onsite Wastewater Systems” to section 200-203 for clarification.

Amended: Deleted “Onsite Wastewater” and added “Permitted” for clarification.

Section 100 Purposes and Scope

Amended: Deleted “human waste” and replaced with “domestic wastewater” for clarity.

Amended: Deleted “best and” and “cost affective” for grammatical purposed.

Deleted: Wording “and to prevent the occurrence of public health nuisances” because it is no longer applicable

Deleted: Letter F “They will not give rise to a public health nuisance” because it is no longer applicable.

**In Section 101, Definitions and References, the following changes apply:**

Added: Definition of “Bond.” Definition incorporated from 61.56.2

Added: “Drain Field” and “Absorption Trench” to the “Alternative System” definition due to these being common names used for wastewater infiltration trench within the industry and public.

Added: Definition of “Cleaning.” Definition incorporated from R.61-56.1.

Added: Definition of “Construction.” Definition incorporated from R.61-56.2.

Added: Definition of “Dwelling” to encompass multiple types of residential structures for which an onsite wastewater system would be required, including tiny homes and park model RVs.

Added: Definition of “Gray Water” to accommodate its separation from other toilet wastewater within Appendix S and Appendix T.

Added: Definition of “License.” Definition incorporated from R.61-56.1 and R.61-56.2.

Added: Definition of “Licensed Onsite Wastewater System Installer” to define the term and specify the scope of authorized activities for each “Tier 1 Installers,” “Tier 2 Installers,” and “Tier 3 Installers.”

Added: Definition of “Nonwater-Carried Sewage Treatment System” to address sites that do not qualify for a conventional, alternative, or engineered onsite wastewater system.

Amended: Definition of “Onsite Wastewater System” to add “Commercial Onsite Wastewater System” for clarity due to this term being used throughout the regulation. Also added language for clarification as it relates to Nonwater-Carried Sewage Treatment Systems (Appendix S) and Combustion Systems (Appendix T).

Added: Definition of “Other Sewage Holding System.” This term was added into the title for the pumpers portion of the regulation to encompass sewage holding systems other than onsite wastewater systems and self-contained toilets.

Amended: Definition of “Perched Zone of Saturation” to remove “A soil horizon that is a perched water table soil horizon that is intermittently saturated with water above a soil horizon that is not saturated with water” and replace with “a saturated zone above an unsaturated zone” for simplicity.

Amended: Definition of “Permit” to change “survives” to “spans” for clarity and to reference nonwater-carried sewage treatment systems and wastewater combustion systems.

Added: Definition of “Pumping and Transporting Vehicle” for clarification on the vehicles the Department approves for cleaning and transporting septage and sewage.

Amended: Definition of “Redox Depletions” to remove “seasonally” for accuracy because saturated conditions can occur at any time of the year.

Amended: Definition of “Redoximorphic Feature” to remove “seasonally” for accuracy because saturated conditions can occur at any time of the year.

Amended: Definition of “Repair or Replacement Area” to specify that the area will be identified on the Permit to Construct.

Added: Definition of “Revocation.” Definition incorporated from R.61-56.1 and R.61-56.2 and expanded to encompass licenses, permits, and approvals to operate.

Added: Definition of “Rippable Rock” for clarification.

Added: Definition of “Self-Contained Toilet.” Definition incorporated from R.61-56.1.

Added: Definition of “Septage.” Definition incorporated from R.61-56.1.

Added: Definition of “Sewage.” Definition incorporated from R.61-56.1.

Added: Definition of “Site” for clarification on an area or plot of land that can be evaluated for an onsite wastewater system.

Added: Definition of “Soils Report” for clarification due to Professional Soil Classifiers issuing these reports to the Department for the purpose of a site evaluation.

Amended: Definition of “Standard” for clarity and to encompass full scope of standards included in the regulation.

Added: Definition of “Surety Agreement.” Definition incorporated from R.61-56.2.

Added: Definition of “Suspension.” Definition incorporated from R.61-56.1 and R.61-56.2 and expanded to include permits to construct, approvals to operate, and licenses.

Added: Definition of “Third-Party” to align with the proposed revisions of third-party involvement during the onsite wastewater evaluation/permitting process.

Added: Definition of “Wastewater Combustion System” to address sites that do not qualify for a conventional, alternative, or engineered onsite wastewater system.

Amended: Definition of “Wastewater Infiltration Trench.” This definition is obsolete due to the addition of System Standard 100.

Section 101.2 References. Deleted (1) and (2) because it is not needed.

## **Section 102 Onsite Wastewater System Site Evaluation and Fees (Added to incorporate R.61-55)**

Section 102.1. Added to propose a new approach to onsite wastewater system fees, including four fee levels. This new approach expands options currently available to permit applicants.

Section 102.2. Added to clarify which individuals are authorized to perform onsite wastewater soil evaluations.

Section 102.3. Added to clarify which individuals are authorized to produce system layouts of onsite wastewater systems.

Section 102.4. Added to clarify which individuals are authorized to conduct final inspections and approval for onsite wastewater systems, how final inspections and approval should be conducted and scheduled, and what documentation should be submitted to the Department.

Section 102.5. Added to specify third-party quality control evaluations conducted by the Department.

Section 102.6. Added to summarize all proposed application schedules, who will perform what work, and the fees associated with each level.

## **Section 103 Onsite Wastewater Systems (formerly Section 102 General)**

Section 103 (formerly 102) was renumbered to adjust the codification and retitled to differentiate between the incorporation of R.61-55, R.61-56.1, and R.61-56.2.

Section 103.1(1). Deleted “unit, building” and left the word “dwelling” to align with new definition of dwelling which encompasses many structures.

Section 103.1(2). Added clarification for Nonwater-Carried Sewage Treatment Systems and Wastewater Combustion Systems.

Section 103.1(3). Deleted “building” and added “dwelling, business, or other structure” to align with new definition of dwelling which encompasses many structures. Added clarification for Nonwater-Carried Sewage Treatment Systems and Wastewater Combustion Systems.

Section 103.1(5)(b). Rephrased the beginning of the provision to read “If a public entity owns the system, the entity” for clarity.

Section 103.1(5)(e). Added title of R.61-67.300 for clarification.

Section 103.2. Added title of R.61-9.505 for clarification.

Section 103.4(3). Deleted “unsewered” so as not to duplicate the first sentence within this section that already details the campgrounds not being furnished with sewer service connections.

Deleted former Section 102.6. Paragraph refers to a system over 1500 gpd, which would represent a large system. The large system standard has the information within this section already included.

## **Section 104 Application and Permit (formerly Section 103 Application, Permit, Approval)**

Section 104 (formerly 103) was renumbered to adjust the codification and retitled to just encompass application and permit.

Section 104.1(1). Added “in a format as identified” and deleted “on the application form provided” for grammatical reasons.

Section 104.1(2). Deleted “and its boundaries” and added “The Department may require a legal description that includes lot boundary lengths” for clarification on required plats, deeds, or other legal document to ensure boundary lengths are included on all when submitted with the onsite wastewater system application.

Section 104.1(4). Added “pertinent” when referring to marking property boundary lines and corners due to large acre lots not requiring all lines and corners be marked, just the ones positioned near the proposed onsite wastewater system.

Section 104.1(5). Added language for clarification of when the Department will not issue a permit.

Section 104.2(1). Amended first sentence to include Nonwater-Carried Sewage Treatment Systems and Wastewater Combustion Systems. Amended last three sentences within this section to better clarify how applicants should submit requests for permit modifications and to expressly specify that a fee will be assessed. Deleted language referring to repair permits.

Section 104.2 (3). Deleted language describing that the Department may authorize a method of repair to an existing onsite wastewater system and revised in section 704.

Former Section 103.3. Deleted (1). Deleted (2) and relocated to section 102.4(1)(c) for better alignment.

## **Section 200 Minimum Site Conditions**

Section 200.6. Added “excluding solid pipes” language to denote that solid pipes do not require the same setbacks as the rest of the onsite wastewater system.

Section 200.6(2). Deleted and relocated to the large system standard the language pertaining to setback to a receptor. Also amended language pertaining to a public well because such language is stated in 200.6(3).

Section 200.6(4). Added “and retention ponds” language to address setbacks to retention ponds which were not previously addressed within the regulation.

Section 200.6(6). Added “including detention ponds (determined by maximum water elevation)” language to address setbacks to detention ponds which were not previously addressed within the regulation.

Section 200.6(7). Added language to address setbacks to piped drainage ditches which were not previously addressed within the regulation.

Section 200.7(1). Deleted language referring to impervious material and relocated language to section 200.7(2).

Section 200.8. Amended section number reference to reflect new text codification.

## **Section 201 Minimum Requirements for Primary Treatment**

Section 201.1(4). Deleted “including condominiums, apartments, and mobile homes” to align with new definition of dwelling which encompasses many structures. Added “septic tank” to clarify minimum septic tank capacities required for multiple dwellings.

Section 201.2(2). Deleted paragraph and replaced with one sentence for simplification.

## **Section 202 Minimum Requirements for Final Treatment and Disposal Systems**

Section 202.1(8). Amended references to former Appendix R and former Appendix Q to align with new numbering system.

## **Section 203 Construction Criteria**

Section 203.8. Added “Class” in front of each roman numeral for clarification. Deleted the hyphen sign separating “long term.”

## **Section 204 Evaluation of Alternative Infiltration Trench Products**

Section 204.2(3)(a). Amended equation for “Trench Sidewalls” to replace the division sign with a multiplication sign.

Section 204.4. Deleted “backfill” and added “soil cover.” Deleted “Unless a lesser amount is approved by the department” to adequately describe the fill material.

Former Section 302. Deleted in its entirety so that its relevant terms could be consolidated with all other enforcement provisions at Section 704.

Former Section 303. Deleted section because it would no longer adhere to the current proposed changes.

## **Section 302 Changes in Use That Impact Existing Onsite Wastewater Systems (formerly 304)**

Section 302 (formerly 304) was renumbered to adjust to the deleted former Sections 302 and 303.

Amended language for clarification.

## **Former Section 305 Severability Clause**

Former Section 305. Deleted to eliminate duplication within the regulation.

## **Section 400 Appendices of Standards for Onsite Wastewater Systems**

Section 400 section numbers have been deleted so only appendices represent each section.

Each Appendix has been renumbered to adjust codification.

Appendix A. Added Appendix A and associated diagram to represent a conventional onsite wastewater system for clarification.

Appendix B(1)(b). Added this deleted language from section 200.6 as this statement specifically refers to the large system standard.

Appendix B(1)(h)(iv). Amended to correct internal citation.

Appendix C(1)(c). Added “Class” in front of the roman numerals for clarification.

Former Appendix C, Section 402.2(1). Deleted to allow serial distribution if it can be demonstrated.

Appendix C(2)(b). Deleted “maximum” and “the minimum width shall be eighteen (18) inches.” This standard requires that the only permissible trench width be thirty-six (36) inches.

Appendix C System Standard Diagram. Amended for diagram clarity, to add “Services” to the Department name, and to align with the revised trench width in Appendix C(2)(b).

Appendix D(1)(c). Added “Class” in front of the roman numerals for clarification.

Former Appendix D, Section 403.2(1). Deleted to allow serial distribution if it can be demonstrated.

Appendix D(2)(b). Deleted “maximum” and “the minimum width shall be eighteen (18) inches.” This standard requires that the only permissible trench width be thirty-six (36) inches.

Appendix D System Standard Diagram. Amended for diagram clarity, to add “Services” to the Department name, and to align with the revised trench width in Appendix D(2)(b). Appendix E was renamed to align with title in Table of Contents.

Appendix E(1)(d). Amended language for clarification.

Appendix E(2)(a). Deleted “maximum,” “must not exceed,” and “the minimum width shall be eighteen (18) inches” and added “shall be.” This standard requires that the only permissible trench width be thirty-six (36) inches.

Appendix E(2)(c). Deleted “backfill” and added “of soil cover” for clarification. Fill caps are constructed from foreign soil brought to the site and not from backfill soil excavated from trenches on site. Deleted “see attached illustration” because language is not necessary.

Appendix E(2)(e). Added language for clarification.

Appendix E System Standard Diagram. Amended for diagram clarity, to add “Services” to the Department name, and to align with the revised trench width in Appendix E(2)(a).

Appendix F(1)(d). Amended language for clarification.

Appendix F(2)(a). Deleted “maximum,” “must not exceed,” and “the minimum width shall be 18 inches” and added “shall be.” This standard requires that the only permissible trench width be thirty-six (36) inches.

Appendix F(2)(3). Deleted “see attached illustration” for consistency.

Appendix F(2)(e). Added language to increase systems versatility to address varying site conditions.

Appendix F System Standard Diagram. Amended for diagram clarity, to add “Services” to the Department name, and to align with the revised trench width in Appendix F(2)(a).

Appendix G(1)(c). Amended to correct internal citation.

Appendix G(2)(a). Deleted “aggregate” and added “of approved aggregate” to clarify that only approved aggregate shall be utilized.

Appendix G System Standard Diagrams (A) and (B). Amended for diagram clarity and to add “Services” to the Department name.

Appendix H(1)(d). Amended language for clarification.

Appendix H(2)(a). Deleted “maximum,” “must not exceed,” and “the minimum width shall be eighteen (18) inches” and added “shall be.” This standard requires that the only permissible trench width be thirty-six (36) inches.

Appendix H(2)(d). Deleted “see attached illustration” for consistency.

Appendix H(2)(e). Added language to increase systems versatility to address varying site conditions.

Appendix H System Standard Diagram. Amended for diagram clarity, to add “Services” to the Department name, and to align with the revised trench width in Appendix H(2)(a).

Former Appendix I, Section 408.1(1). Deleted to increase systems versatility to address varying site conditions.

Former Appendix I, Section 408.1(2). Deleted language because it is no longer applicable.

Appendix I(1)(d). Deleted “as computed in the following table” because it is not applicable due to table deletion. Deleted table titled “Factors (F) for Maintaining Equivalent Infiltrative Surface Area” to avoid duplication with the system standard diagram.

Appendix I(2)(a). Deleted “shall always be kept as narrow as possible” for simplicity.

Appendix (I) System Standard Diagram. Amended for diagram clarity, to add “Services” to the Department name, and to align the equation presented in the table on the diagram to the equation presented in section 204.2. Also corrected reference to total infiltrative surface area per linear foot of conventional type trench to read 5.33 sq ft/ft.

Appendix J(1)(a). Amended language to update internal citation to align with the new numbering system.

Appendix J(2)(a). Deleted “aggregate” and added “of approved aggregate” to clarify that only approved aggregate shall be utilized.

Appendix J System Standard Diagram. Amended for diagram to add “Services” to the Department name. System Diagram was not revised.

Appendix J (9)(b). Deleted sentence defining rippable rock and replaced with new definition in Section 101.

Appendix K. Added Appendix K and associated diagram to represent an alternative trench width and depth system with fill cap to allow for conservative components of two different systems to be used in conjunction with one another depending on site conditions.

Appendix L(2)(d). Deleted “see attached sketch” for consistency.

Former Appendix L, Section 401.2(9). Deleted text and table as the same table is displayed in the system standard diagram.

Appendix L System Standard Diagram. Amended for diagram clarity and to add “Services” to the Department name.

Appendix M System Standard Diagram. Amended for diagram clarity and to add “Services” to the Department name.

Appendix N(2)(b) and (2)(b)(ii). Amended to delete “see ref. sketch” for consistency.

Appendix N System Standard Diagram. Amended for diagram clarity and to add “Services” to the Department name.

Appendix O(2)(b)(i). Deleted “seasonal.” Saturation can occur at any time of the year.

Appendix O(2)(b)(ii) and (iii). Added language regarding individual system layout.

Appendix O(2)(b)(vii) and (viii). Added “class” in front of roman numeral for clarification. Deleted “see attached illustration” for consistency.



Appendix O System Standard Diagrams. Amended for diagram clarity and to add “Services” to the Department name. Added Diagrams B and C for clarification and demonstration.

Appendix P(2)(c)(ii). Added language for further clarification regarding design and installation of low pressure pipe distribution.

Appendix P(3)(a). Added “one” for clarification and to align with required formatting.

Appendix P System Standard Diagrams. Amended for diagram clarity and to add “Services” to the Department name.

Appendix Q(1)(b)(iii). Added language to clarify offsets to environmentally sensitive waters.

Appendix Q(1)(b)(vi). Added language at the request of stakeholder input to address operation and maintenance concerns.

Appendix Q(1)(d). Added language to further define reporting requirements of installation (i.e. requirements related to submission of as-built plans).

Appendix R(1)(b). Deleted “and shall range in size from one half (1/2) inch to two and one half (2 ½) inches. Fines are prohibited”. Due to increased technology, approved aggregate for this system standard is not limited to just gravel.

Appendix R(1)(c). Added “utilizing tire chips or gravel or a similar type of approved product”. Due to increased technology, approved aggregate for this system standard is not limited to just gravel.

Appendix R(1)(e). Deleted “A minimum one (1) percent fall (12 inches per 100 feet) shall be utilized” to increase systems versatility to address varying site conditions.

Appendix R(1)(o). Added “inspection port” for clarification.

Appendix R System Standard Diagrams. Amended for diagram clarity and to add “Services” to the Department name.

Appendix S. Added Appendix S and associated diagram to represent Nonwater-Carried Sewage Treatment Systems for areas that would not qualify for a traditional onsite wastewater system.

Appendix T. Added Appendix T and associated diagram to represent Wastewater Combustion Systems for areas that would not qualify for a traditional onsite wastewater system.

## **Section 500 - Long Term Acceptance Rate Standard for Onsite Wastewater Systems (Formerly Appendix Q - Long-Term Acceptance Rate Standard for Onsite Wastewater Systems)**

Section 500 (formerly 500 Appendix Q) was renumbered to adjust the codification and retitled to correct a grammatical error with the language “long term.”

Section 500, chart. Deleted “Sandy” and added “Sand” to align with the grammatical structure of the other soil characteristic descriptions in the table.

Section 500, chart. Added soil texture “Silt.” Silt is one of the soil textures described in the USDA-NRCS Field Book for Describing and Sampling Soils.

## **Section 501 - Peak Sewage Flow Rate Standard (formerly 501 Appendix R - Peak Sewage Flow Rate Standard)**

Section 501 (formerly 501 Appendix R) was renumbered to adjust the codification.

Section 501. Added “Hotel” to the motel row for clarification.

Section 501. Added “Dwelling” to the Residential row and deleted the examples for residential to align with the new dwelling definition. The definition encompasses multiple residential structures for which an onsite wastewater system would be required.

Section 501. Added a row for “Residential Out-Building” to accommodate the current demand for these types of systems.

## **Section 502 - Onsite Wastewater Pump System Standard (formerly 600 Appendix S - Onsite Wastewater Pump System Standard)**

Section 502 (formerly 600 Appendix S) was renumbered to adjust the codification.

Section 502.1(3). Deleted “seasonal” for simplification because saturated conditions can occur at any time of the year.

Section 502.2(1). Deleted “the Standard for Determining Sewage Flow Rates from Commercial and Recreational Establishments” and replaced with Section 501, Peak Sewage Flow Rate Standard for clarification.

Section 502.4(6). Added language to state that force mains crossing ditches, bodies of water, under driveways, and parking areas must be encased within another pipe to withstand damage for extra protection and safety reasons.

## **Section 503 - Minimum Design Standards for Tank Construction (formerly 700 Appendix T - Minimum Design Standards for Tank Construction)**

Section 503 (formerly 700 Appendix T) was renumbered to adjust the codification.

Section 503.1. Deleted “disposal” to align with the revisions that describe septic systems as onsite wastewater systems, not onsite wastewater disposal systems.

Section 503.2(1) and (7). Deleted “disposal” to align with the revisions that describe septic systems as onsite wastewater systems, not onsite wastewater disposal systems.

Section 503.2(3) and (6). Amended to change “make” to “submit a” for clarity.

Section 503.3(17). Amended language to read “risers or manhole covers, as applicable” for clarity.

Section 503.3(20). Amended “local health department” to read “Department” for clarity and accuracy.

## **Section 504 - Fiberglass Reinforced Plastic Tanks Standard (formerly 800 Appendix U - Fiberglass Reinforced Plastic Tanks Standard)**

Section 504 (formerly 800 Appendix U) was renumbered to adjust the codification.

Section 504. Amended to change “assure” to “to insure” for clarity.

Section 504.1. Amended “herein” to read “within this regulation” for clarity and deleted second use of word “herein” for clarity.

Section 504.1(7). Amended “present” to read as “have” for clarity.

Section 504.3(1)(d). Amended to change “Division of Onsite Wastewater Management” to “Department” for consistency and clarity.

### **Section 505 - Thermoplastic Tanks Standard (formerly 900 Appendix V - Thermoplastic Tanks Standard)**

Section 505 (formerly 900 Appendix V) was renumbered to adjust the codification.

Section 505(2). Amended to change “Division of Onsite Wastewater Management” to “Department” for consistency and clarity.

Section 505(3). Added language to require that thermoplastic tank manufacturers renew their product approval every five years for consistency.

### **Section 600 License to Clean Onsite Wastewater Systems, Self-Contained Toilets, and Sewage Holding Systems (i.e., Pumper/Hauler)**

Section 600 (including language formerly appearing in R.61-56.1) was added to encompass pumper/hauler licensing.

Section 600.1. Added section to state that no person shall engage in the business of pumping without a license.

Section 600.2. Added section to identify requirements for licenses, applications, and fees related to the cleaning of onsite wastewater systems, self-contained toilets, and other sewage holding systems. This section includes information for how license applications should be submitted, parameters for vehicle inspections, testing requirements, and fees.

Section 600.3. Added section allowing other governmental entities to have requirements that are more stringent than state requirements.

Section 600.4. Added section allowing sewer providers using pumping and transporting vehicles for the sole purpose of maintaining their sewer systems to be exempt from the licensing requirements of Section 600 of this regulation.

### **Section 601 Vehicles, Equipment, and Practices**

Section 601 (including language formerly appearing in R.61-56.1) was added to encompass requirements related to vehicles, equipment, and practices for removal and transport of septage and sewage.

Section 601.1. Added section establishing vehicles requirements related to pumping.

- Section 601.2. Added section specifying proper cleaning processes for pumpers.
- Section 601.3. Added section specifying disposal requirements for the septage material.
- Section 601.4. Added section establishing supervisory requirements for the licensee.

## **Section 602 Records of Operation**

Section 602. Added section in its entirety (including language formerly appearing in R.61-56.1) summarizing the record keeping requirements for the handling and disposal of septage material.

## **Section 700 Licensing of Installers**

Section 700.1 Added section (including language formerly appearing in R.61-56.1, as amended) identifying requirements for licenses, application, and fees associated with the licensure of an installer. This includes the three tiers of licensing and associated fees and eligibility requirements.

## **Section 701 Continuing Education and Training**

Section 701. Added section in its entirety defining new continuing education requirements and their implementation.

## **Section 702 Practice, Procedure, and Quality Control**

Section 702. Added section in its entirety setting forth operating constraints within each tier of installer and expected quality control measures from the Department.

## **Section 703 Bonding and Insurance Requirements: Tier 3 Installers**

Sections 703.1, 703.2, and 703.3. Added provisions requiring bonding and insurance for Tier 3 installers.

## **Section 704 Enforcement**

Section 704. Added section in its entirety to consolidate in one section all enforcement provisions pertaining to violations of the regulation and suspension and revocation of Department permits to construct, approvals to operate, and licenses. This section includes enforcement provisions from the current R.61-56, R.61-56.1, and 61-56.2. Changes to the current provisions have been made to clarify and avoid duplication. Additional language has been added consistent with statute regarding enforcement of violations by persons licensed to install or clean onsite wastewater systems.

## **Section 705 Severability Clause**

Section 705. This section added to shift it from its current location in the regulations, for clarity.

## **Notice of Public Hearing and Opportunity for Public Comment:**

Interested persons may submit comment(s) on the proposed amendments by mail to David Vaughan of the Bureau of Environmental Health Services at the S.C. Department of Health and Environmental Control, 2600 Bull Street, Columbia, S.C. 29201; fax at (803)896-0645; or email at [vaughadr@dhec.sc.gov](mailto:vaughadr@dhec.sc.gov). To be considered, the Department must receive the comment(s) by 5:00 p.m. on November 26, 2018, the close of the comment period.

The S.C. Board of Health and Environmental Control will conduct a public hearing on the proposed amendments during its December 13, 2018, 10:00 a.m. meeting. Interested persons may make oral and/or submit written comments at the public hearing. Persons making oral comments should limit their statements to five (5) minutes or less. The meeting will take place in the Board Room of the DHEC Building, located at 2600 Bull Street, Columbia, S.C. 29201. Due to admittance procedures, all visitors must enter through the main Bull Street entrance and register at the front desk. The Department will publish a meeting agenda twenty-four (24) hours in advance indicating the order of its scheduled items at: <http://www.scdhec.gov/Agency/docs/AGENDA.PDF>.

The Department publishes a Monthly Regulation Development Update tracking the status of its proposed new regulations, amendments, and repeals and providing links to associated State Register documents at <http://www.scdhec.gov/Agency/RegulationsAndUpdates/RegulationDevelopmentUpdate/>.

### **Preliminary Fiscal Impact Statement**

There is no anticipated additional cost to the Department or state government due to any requirements of this amendment.

### **Statement of Need and Reasonableness**

The following presents an analysis of the factors listed in 1976 Code Section 1-23-115(C)(1)-(3) and (9)-(11):

DESCRIPTION OF REGULATIONS: 61-55, Septic Tank Site Evaluation Fees; 61-56, Onsite Wastewater Systems; 61-56.1, License To Construct Or Clean Onsite Sewage Treatment And Self-Contained Toilets; and 61-56.2, Licensing Of Onsite Wastewater Systems Master Contractors

Purpose: The Department proposes amending the requirements of R.61-55, R.61-56, R.61-56.1, and R.61-56.2 to reflect changes in design, construction, and installation of onsite wastewater system nomenclature and technology; clarify existing definitions; and add new definitions and standards for site and system requirements. Additional amendments are proposed to improve clarity and consistency, as well as upgrade the overall quality and practicality of the regulation. The proposed revisions also include a new schedule of site evaluation procedures and fees to provide applicants additional options for obtaining a permit to construct onsite wastewater treatment systems. Under the new tiered system, the existing, standard site evaluation procedures and fee would be supplemented by additional options for applicants to submit third-party soils work and/or pay increased fees, allowing for more streamlined and expedited permit processing. The Department further proposes combining the regulations into a single regulation, R.61-56, through repeal of R.61-55, R.61-56.1 and R.61-56.2 in the interest of efficiency.

Legal Authority: 1976 Code Sections 44-1-140(11), 44-1-150, 44-55-827, and 48-1-10 et seq.

Plan for Implementation: The DHEC Regulation Development Update (accessible at <http://www.scdhec.gov/Agency/RegulationsAndUpdates/RegulationDevelopmentUpdate/>) provides a summary of and link to these proposed amendments/repeals. Additionally, printed copies are available for a fee from the Department's Freedom of Information Office. Upon taking legal effect, Department personnel will take appropriate steps to inform the regulated community of the amendments/repeals and any associated information.

DETERMINATION OF NEED AND REASONABLENESS OF THE PROPOSED REGULATION BASED ON ALL FACTORS HEREIN AND EXPECTED BENEFITS:

The proposed amendments and repeals are needed and reasonable, as they will provide clarification regarding the requirements and standards contained R.61-56 and consistency with the latest scientific, industrial, and technological changes in onsite wastewater system design, construction, and installation. Furthermore, the proposed amendments will simplify the licensure of those operators that clean or pump sewage treatment and disposal systems and, for organization and clarity, provide a tiered structure for the licensure of operators that construct or install these systems, including increased fees for the licensure and renewal of licenses. The proposed tiered site evaluation and fee schedule will both expand options available to the public for streamlining or expediting the permit application process, and also provide increased resources to allow the Department to provide the needed level of oversight of this industry, which protects the environment and the public. The program is currently funded by approximately sixty (60) percent state funding and forty (40) percent fees. Based on financial projections, current funding levels will not be able to sustain the program given current operating costs. The proposed fee increases in conjunction with existing state funding will better enable the Department to cover onsite wastewater program operating costs.

#### DETERMINATION OF COSTS AND BENEFITS:

**Internal Costs:** Implementation of these amendments will not require additional resources. There is no anticipated additional cost to the Department or state government due to any inherent requirements of these revisions.

**External Costs:** The proposed amendments include a cost to the public in the form of additional licensure fees and late fees. Currently, the program only collects license processing fees for one of the four (4) licensing procedures offered. The proposed increased and additional licensing fees will help to recoup the cost of vehicles inspections, proctoring of exams, and associated administrative activities. Future cost projections indicate that the onsite wastewater program will not be able to sustain itself in as little as three (3) years with the current intake of fees. It is necessary for the Department to offset that deficit by raising licensing fees.

In addition, the proposed revisions would expand existing site evaluation options and allow more streamlined permit processing by permitting an applicant to select from four available site evaluation procedures and fee levels. Under this proposed schedule, the existing, standard site evaluation procedures and fee would be supplemented by additional options for applicants to submit third-party soils work and/or pay increased fees, allowing for more streamlined and expedited permit processing. For those applicants seeking conventional systems and wishing to pay the existing, standard Department site evaluation fee, they may continue to do so under the new proposed site evaluation and fee schedule.

**External Benefits:** These amendments upgrade overall quality and practicality, improve clarity and consistency, reflect changes in design, construction, and installation of onsite wastewater system nomenclature and technology, separate the licensing of pumper/haulers and installers, expand options for obtaining permits, clarify existing definitions, and add new definitions and standards for site and system requirements.

#### UNCERTAINTIES OF ESTIMATES:

None.

#### EFFECT ON THE ENVIRONMENT AND PUBLIC HEALTH:

There is no anticipated negative environmental or public health effect resulting from the proposed amendments and repeals of these regulations.

DETRIMENTAL EFFECT ON THE ENVIRONMENT AND PUBLIC HEALTH IF THE REGULATION IS NOT IMPLEMENTED:

The negative effect on the environment and public health if the proposed amendment of this regulation is not implemented would be less efficiency and clarity for industry and reduced resources for the Department to provide necessary oversight of the disposal of septage and sewage.

**Statement of Rationale:**

The Department proposes amending the requirements of R.61-55, R.61-56, R.61-56.1, and R.61-56.2 to reflect changes in design, construction, and installation of onsite wastewater system nomenclature and technology; clarify existing definitions; and add new definitions and standards for site and system requirements. Additional amendments are proposed to improve clarity and consistency, as well as upgrade the overall quality and practicality of the regulation. The proposed revisions also include a new schedule of site evaluation procedures and fees to provide applicants additional options for obtaining a permit to construct onsite wastewater treatment systems. The Department further proposes combining the regulations into a single regulation, R.61-56, through repeal of R.61-55, R.61-56.1 and R.61-56.2 in the interest of efficiency.

**Text:**

~~Indicates Matter Stricken~~

Indicates New Matter

**~~61-55. Septic Tank Site Evaluation Fees.~~**

~~SECTION I. PURPOSE~~

~~A major factor influencing the health of individuals where public sewer is not available is the proper treatment and disposal of human excreta and other domestic wastes. To this end and to protect the environment from contamination by untreated sewage, the Department of Health and Environmental Control has established and maintained a conscientious program of designing individual sewage treatment and disposal systems, evaluating sites for suitability for individual sewage treatment and disposal systems and approving the installations of such systems. This direct service program is conducted primarily by public health professionals working in county health departments. Funding for the program comes from state appropriations and the fees authorized by this regulation.~~

~~SECTION II. DEFINITIONS~~

~~The following definitions shall apply in the interpretation and enforcement of this regulation.~~

~~A. DEPARTMENT—The South Carolina Department of Health and Environmental Control.~~

~~B. HEALTH AUTHORITY—An authorized representative of the South Carolina Department of Health and Environmental Control.~~

~~C. INDIVIDUAL SEWAGE TREATMENT AND DISPOSAL SYSTEM—A system designed for the treatment and disposal of sewage by a septic tank and soil absorption trench. The term also includes alternatives to septic tanks and soil absorption trenches when such alternatives are approved by the Health Authority under the provisions of *R.61-56, Individual Sewage Treatment and Disposal Systems*~~

~~D. PERMIT— A written statement issued by the Health Authority permitting the construction of an individual sewage treatment and disposal system under the provisions of R.61-56, Individual Sewage Treatment and Disposal Systems~~

### ~~SECTION III. FEES~~

~~—The Department shall charge a fee of \$150.00 to evaluate the site of a proposed individual sewage treatment and disposal system. This fee shall be paid prior to the evaluation of any site for which an application for a permit has been made.~~

### ~~SECTION IV. OTHER~~

#### ~~A. DESIGNATION OF USE~~

~~Funds derived from these fees shall be used only for the provision of services and accompanying expenses associated with Environmental Health programs.~~

#### ~~B. UNCONSTITUTIONALITY CLAUSE~~

~~Should any chapter, paragraph, sentence, clause, or phrase of this regulation be declared unconstitutional or invalid for any reason, the remainder of this regulation shall not be affected thereby. [Repealed]~~

61-56. Onsite Wastewater Systems.

Statutory Authority: 1976 S.C. Code Section(s) 44-1-140(11), 44-1-150, 44-55-827, and 48-1-10 et seq.

### TABLE OF CONTENTS:

100	Purposes and Scope
101	Definitions and References
102	<u>Onsite Wastewater System Site Evaluation and Fees</u>
<del>102</del>	<del>General</del> <u>103 Onsite Wastewater Systems</u>
<del>103</del>	<del>Application, Permit, Approval</del> <u>104 Application and Permit</u>
200	Minimum Site Conditions <u>for Onsite Wastewater Systems</u>
201	Minimum Requirements for <u>Onsite Wastewater System</u> Primary Treatment
202	Minimum Requirements for <u>Onsite Wastewater System</u> Final Treatment and Disposal Systems
203	<u>Onsite Wastewater System</u> Construction Criteria
204	Evaluation of Alternative Infiltration Trench Products
300	Wastewater Treatment Facility Accessibility
301	Discharge of Waste
302	Enforcement Provisions <u>for Permits</u>
<del>303</del>	<del>Repeal and Date of Effect</del>
304	<del>303</del> Changes in Use that Impact Existing Onsite Wastewater Systems
<del>305</del>	<del>Severability Clause</del>
400	Appendices of Standards for <u>Onsite Wastewater Permitted</u> Systems
	<u>Appendix A - System Standard 100/101 – Conventional with 14-Inch Aggregate Depth</u>
<del>401</del>	<del>Appendix A</del> <u>B - System Standard 150 - Large (greater than 1500 gpd) and Community Systems</u>
<del>402</del>	<del>Appendix B</del> <u>C - System Standard 210/211 - Shallow Placement</u> <del>With</del> <u>with</u> 9-Inch Aggregate Depth
<del>403</del>	<del>Appendix C</del> <u>D - System Standard 220/221 - Shallow Placement</u> <del>With</del> <u>with</u> 6-Inch Aggregate Depth



~~404 Appendix D E~~ - System Standard 230/231 - Shallow Placement ~~With~~ with 14-Inch Aggregate Depth ~~With~~ with Fill Cap  
~~405 Appendix E F~~ - System Standard 240/241 - Ultra-Shallow Placement ~~With~~ with 6-Inch Aggregate Depth ~~With~~ with Fill Cap  
~~406 Appendix F G~~ - System Standard 250/251 - Reservoir Infiltration System ~~For~~ for Soils ~~With~~ with Expansive Clay  
~~407 Appendix G H~~ - System Standard 260/261 - 9-Inch Shallow Placement System ~~With~~ with Fill Cap System  
~~408 Appendix H I~~ - System Standard 270/271 - Alternative Trench Width and Depth Systems  
~~409 Appendix I J~~ - System Standard 280/281 - Reservoir Infiltration System ~~For~~ for Soils ~~With~~ with Expansive Clay Shallow Rock Formations  
Appendix K - System Standard 290/291 – Alternative Trench Width and Depth Systems with Fill Cap  
~~410 Appendix J L~~ - System Standard 370/371 - Shallow Placement ~~With~~ with Fill Cap for Sites ~~With~~ with Shallow Class IV Soil  
~~411 Appendix K M~~ - System Standard 380/381 - Double Aggregate Depth Wastewater Infiltration Trenches  
~~412 Appendix L N~~ - System Standard 420/421 - Mounded Infiltration System  
~~413 Appendix M O~~ - System Standard 431 - Mounded Fill System  
~~414 Appendix N P~~ - System Standard 601 - Elevated Infiltration System  
~~415 Appendix O Q~~ - System Standard 610 - Specialized Onsite Wastewater System Designs (~~Less Than~~ less than 1500 ~~gpd~~ GPD)  
~~416 Appendix P R~~ - Curtain Drain Standard  
Appendix S - Nonwater-Carried Sewage Treatment Systems  
Appendix T - Wastewater Combustion Systems  
~~500 Appendix Q - Long Term~~ Long Term Acceptance Rate Standard ~~For~~ for Onsite Wastewater Systems  
~~501 Appendix R~~ - Peak Sewage Flow Rate Standard  
~~600 Appendix S 502~~ - Onsite Wastewater Pump System Standard  
~~700 Appendix T 503~~ - Minimum Design Standards ~~For~~ for Tank Construction  
~~800 Appendix U 504~~ - Fiberglass Reinforced Plastic Tanks Standard  
~~900 Appendix V 505~~ - Thermoplastic Tanks Standard  
600 License to Clean Onsite Wastewater Systems, Self-Contained Toilets, and Other Sewage Holding Systems (i.e., Pumper/Hauler)  
601 Vehicles, Equipment, and Practices  
602 Records of Operation  
603 Suspension/Revocation of License  
604 Expiration of License  
605 Penalties  
700 Licensing of Installers  
701 Continuing Education and Training  
702 Practice, Procedure, and Quality Control  
703 Bonding and Insurance Requirements: Tier 3 Installers  
704 Enforcement  
705 Severability Clause

## ~~100 PURPOSES and SCOPE~~ **100 Purposes and Scope**

A major factor influencing the health of individuals where public wastewater treatment facilities are not available is the proper onsite treatment and disposal of domestic wastewater. Diseases such as dysentery, cholera, infectious hepatitis, typhoid, and paratyphoid are transmitted through the fecal contamination of food, water, and the land surface largely due to the improper treatment and disposal of domestic wastewater.

For this reason, every effort should be made to prevent such hazards and to treat and dispose of all ~~human~~ domestic wastewater through the practical application of the ~~best and most cost effective~~ effective technology available.

Safe treatment and disposal of domestic wastewater is necessary to protect the health of families and communities, ~~and to prevent the occurrence of public health nuisances~~. Domestic wastewater can be rendered ecologically safe and public health can be protected if such wastes are disposed of so that:

- A. They will not contaminate any drinking water supply.
- B. They will not give rise to a public health hazard by being accessible to insects, rodents, or other possible carriers, which may come into contact with food or drinking water.
- C. They will not give rise to a public health hazard by being accessible to children or adults.
- D. They will not violate federal and state laws or regulations governing water pollution or sewage disposal.
- E. They will not pollute or contaminate any waters of the state.
- ~~F. They will not give rise to a public health nuisance.~~

Where the installation of an onsite wastewater system is necessary, the basic principles of design, construction, installation, operation and maintenance shall be followed.

#### ~~101 DEFINITIONS AND REFERENCES~~ **101 Definitions and References**

##### ~~A. DEFINITIONS:~~ 101.1. Definitions

~~ACCESSIBILITY~~ Accessibility - S.C. Code Sections 44-55-1410 and 5-31-2010 authorizes county and municipal governments to determine if a wastewater treatment facility is accessible to properties. Where annexation or easements to cross adjacent property are required to connect to a wastewater treatment facility, the wastewater treatment facility shall not be considered accessible.

~~ALTERNATIVE SYSTEM~~ Alternative System - —A system incorporating design modifications of the proposed subsurface wastewater infiltration trench area (drain field) or absorption trench geometry for the purpose of achieving compliance with required setbacks and offset to the zone of saturation and/or restrictive horizons. No such system shall be utilized unless the Department has established a specific standard.

~~ALTERNATIVE INFILTRATION TRENCH PRODUCTS~~ Alternative Infiltration Trench Products - Products specifically designed to replace or eliminate the aggregate typically utilized in subsurface infiltration trenches. Such products must be approved for use by the Department and must adhere to required equivalency values established herein.

~~APPLICANT~~ Applicant - — A property owner, general contractor or agent representing the property owner, or developer who seeks a permit to construct and operate an onsite wastewater system.

Bond - A sum of money set aside (Surety Bond) to insure completion of work under a contract.

~~CAMPGROUND~~ Campground - An organized camp in which campsites are provided for use by the general public or certain groups.

~~CANAL~~ Canal - - An artificial waterway used for navigation, drainage, or irrigation.

Cleaning - - The removal and transportation of septage from an onsite wastewater system, self-contained toilet, or other sewage holding system to an approved disposal location.

~~COLOR CHARTS~~ Color Charts (Munsell System or equivalent) - - Charts bearing various color chips established by a recognized color system which uses three elements—hue, value, and chroma—to make up a specific color notation. The notation is recorded ~~if~~ in the form of hue, value, and chroma (e.g., 10YR 5/6). The three attributes of color are arranged in the system in orderly scales of equal visual steps, which are used to measure and describe color accurately under standard conditions of illumination by comparing soil samples to color chips on various charts.

Construction - - The installation or repair of an onsite wastewater system.

~~CONVENTIONAL SYSTEM~~ Conventional System — An onsite wastewater system that utilizes a network of conventional wastewater infiltration trenches installed in the naturally occurring soil for the treatment and disposal of domestic wastewater.

~~CRITICAL AREA~~ Critical Area - S. C. Code Section 48-39-10(J) defines critical area as the following: 1) coastal waters; 2) tidelands; 3) beaches; 4) beach/dune systems which are the areas from the mean high-water mark to the setback line as determined in S. C. Code Section 48-39-280.

~~CURTAIN DRAIN~~ Curtain Drain - - A subsurface interceptor drain that is installed to collect and redirect ~~seasonal~~ groundwater as it flows through the soil profile to an appropriate discharge point.

~~DEPARTMENT~~ Department - - The South Carolina Department of Health and Environmental Control.

~~DITCH~~ Ditch - - A long narrow excavation, intended for the ~~purposes~~ purpose of drainage and/or irrigation.

~~DOMESTIC WASTEWATER OR SEWAGE~~ Domestic Wastewater or Sewage - The untreated liquid and solid human body waste and the liquids generated by water-using fixtures and appliances, including those associated with food service operations. For the purposes of this regulation, domestic wastewater shall not include industrial process wastewater.

Dwelling - A self-contained unit used by one (1) or more households as a home, such as a house, apartment, mobile home, house boat, tiny house, park model RV, permanently or semi-permanently set up RV, or other substantial structure that provides independent living facilities for one (1) or more persons, including permanent or semi-permanent provisions for living, sleeping, eating, cooking, and sanitation.

~~EFFLUENT~~ Effluent - - The liquid discharged from a septic tank, effluent pump station, or other sewage treatment device.

~~EMBANKMENT~~ Embankment - - A bank of soil with at least two (2) feet of vertical height from top to bottom.

~~ENVIRONMENTALLY SENSITIVE WATERS~~ Environmentally Sensitive Waters - - Outstanding resource waters (ORW), Shellfish Harvesting Waters (SFH), and Trout-Natural Waters (TN) as defined in

R.61-68 and classified in R.61-69, and including lakes greater than forty (40) acres in size and the Atlantic Ocean, regardless of their classifications in R.61-69.

~~EXISTING SYSTEM~~ Existing System - An onsite wastewater system, which has received final construction approval or has been serving a legally occupied ~~residence~~ dwelling or structure.

~~EXPANSIVE SOILS~~ Expansive Soils - Soils containing significant amounts of expansible-layer clay minerals (smectites) as evidenced in the field by classifications of “Very Sticky,” “Very Plastic” and where “Slickensides” are present when evaluated in accordance with the Field Book. Such soil horizons are considered to be restrictive for onsite wastewater systems.

~~FAILING ONSITE WASTEWATER SYSTEM~~ Failing Onsite Wastewater System - - An onsite wastewater system that is discharging effluent in an improper manner or has ceased to function properly.

~~FIBERGLASS REINFORCED PLASTIC~~ Fiberglass Reinforced Plastic - A fibrous glass and plastic mixture that exhibits a high strength to weight ratio and is highly resistant to corrosion.

~~FIELD BOOK FOR DESCRIBING AND SAMPLING SOILS~~ Field Book for Describing and Sampling Soils (Field Book) - -A field guide published by the U.S. Department of Agriculture (USDA) Natural Resources Conservation Service (NRCS) for making or reading soil descriptions and for sampling soils, as presently practiced in the USA.

~~FINAL TREATMENT AND DISPOSAL~~ Final Treatment and Disposal - Ultimate ~~disposition~~ discharge of the effluent from a septic tank or other treatment device into the soil.

~~FLEXURAL MODULUS OF ELASTICITY~~ Flexural Modulus of Elasticity - A measure of stiffness of a material.

~~FLEXURAL STRENGTH~~ Flexural Strength - A measure of the ability of a material to withstand rupture when subjected to bend loading.

~~GEL COATING~~ Gel Coating - A specially formulated polyester resin, which is pigmented and contains filler materials, the purpose of which is to provide a smooth, pore-free, watertight surface for fiberglass reinforced plastic parts.

Gray Water - Wastewater that is generated by water-using fixtures and appliances such as sinks (excluding kitchen sinks), showers, and laundry but that does not come into direct contact with human excreta or solid organic matter.

~~GREASE TRAP~~ Grease Trap - A device designed to separate and store the oil and grease component of wastewater discharged from facilities that prepare food.

~~GLEYYING~~ Gleying - - Bluish, greenish, or grayish colors in the soil profile that are indicative of markedly reduced conditions due to prolonged saturation. This condition can occur in both mottled and unmottled soils, and can be determined by using the Gley page of the soil color charts.

~~INDUSTRIAL PROCESS WASTEWATER~~ Industrial Process Wastewater - Non-domestic wastewater generated in a commercial or industrial operation that may or may not be combined with domestic wastewater.

License - The official document issued by the Department authorizing a person to be engaged in the business of construction, repair, or cleaning of onsite wastewater systems, self-contained toilets, and other sewage holding systems

Licensed Onsite Wastewater System Installer (Installer) - A person authorized under this regulation to construct onsite wastewater systems. The specific scope of construction authorized depends on the installer's tier of licensure, as follows:

(1) Tier 1 - May install all gravity-fed residential onsite wastewater systems. This level is not authorized to conduct repairs on existing onsite wastewater systems.

(2) Tier 2 - May install all Tier 1 systems plus pumps, grease traps, systems with curtain drains, elevated infiltration systems, mounded systems, and all commercial onsite wastewater systems. This level is also authorized to conduct repairs on existing onsite wastewater systems.

(3) Tier 3 - May install all Tier 1 and 2 systems plus all Standard 610 specialized onsite wastewater systems. Except as provided in Sections 102.4(1) and 702.2, this level is also authorized to complete self-inspections for onsite wastewater systems they install as well as conduct repairs on existing onsite wastewater systems.

~~LONG TERM ACCEPTANCE RATE~~ Long Term Acceptance Rate (LTAR) - – The ~~long-term~~ long term rate, typically expressed in gallons per day (gpd) per square foot of trench bottom area, at which a mature onsite wastewater system can continue to accept effluent without hydraulic failure occurring. This flow rate is a result of the interaction between unsaturated soil hydraulic conductivity and biomat resistance.

~~MOTTILING~~ Mottling – Morphological features of the soil revealed as spots or blotches of different color or shades of color interspersed with the dominant matrix color.

~~NSF STANDARD~~ NSF Standard #14 - A National Sanitation Foundation Standard relating to thermoplastics, which have been tested and found satisfactory for potable water supply uses, ~~and for drains, waste, and vent applications.~~

Nonwater-Carried Sewage Treatment System - A self-contained system for waste treatment (such as a biological, composting, or incinerating toilet) that stores, treats, and renders human urine and feces inert without the use of water and that is designed to not discharge into the soil, onto the soil surface, into bodies of water, or other external media.

~~ONSITE WASTEWATER SYSTEM~~ Onsite Wastewater (OSWW) System - – A system, generally consisting of a collection sewer, septic tank(s), and subsurface wastewater infiltration area, designed to treat and dispose of domestic wastewater through a combination of natural processes that ultimately result in effluent being transmitted through the soil, renovated, and ultimately discharged to groundwater. For purposes of Section (3) of Appendix S and Section (3) of Appendix T only, an onsite wastewater system shall also include such a system as described above for the treatment and disposal of gray water.

(1) Small Onsite Wastewater System— An individual system serving an individually deeded ~~residence~~ dwelling or business that generates less than fifteen hundred (1500) ~~gallons per day~~ gpd of domestic wastewater. Management and maintenance of each system is the responsibility of the individual property owner.

(2) Large Onsite Wastewater System (General) -—An individual system that treats and disposes of domestic wastewater discharges in excess of fifteen hundred (1500) ~~gallons per day~~ gpd.

(a) Privately Owned Large System— A large onsite wastewater collection and treatment system that serves one piece of deeded property such as a school, adult residential care facility, rental apartment complex, shopping center, campground, mobile home park, office complex, etc.. Management and maintenance of the system is the responsibility of the individual property owner.

(b) Community (Cluster) System -—A wastewater collection and treatment system that provides shared collection, treatment, and disposal of domestic wastewater from multiple parcels or multiple units of individually deeded property. Such a system might serve a small subdivision or a condominium complex. It is imperative with such systems that some form of common ownership and management be established and approved by the Department.

(c) Commercial Onsite Wastewater System - An onsite wastewater system that serves a facility other than a private dwelling intended for the engagement of commerce.

~~OPERATION AND MAINTENANCE~~ Operation and Maintenance - — Activities including tests, measurements, adjustments, replacements, and repairs that are intended to maintain all functional units of the onsite wastewater system in a manner that will allow the system to function as designed.

Other Sewage Holding System - Components of a sewer system or holding tank not related to an onsite wastewater system, including grease traps.

PARENT MATERIAL - —The unconsolidated and chemically weathered mineral or organic matter from which the column of soils is developed by pedogenic processes.

~~PERCHED ZONE OF SATURATION~~ Perched Zone of Saturation (Episaturation) - —A soil horizon that is a perched water table soil horizon that is intermittently saturated with water above a soil horizon that is not saturated with water. A zone of saturation above an unsaturated zone.

PERMIT Permit - A written document issued by the Department authorizing the construction and operation of an onsite wastewater system, nonwater-carried sewage treatment system, or wastewater combustion system under this regulation. The construction and operation permit ~~survives~~ spans the life of the onsite wastewater system that it authorizes.

PLASTICITY Plasticity - — The degree to which “puddled” or reworked soil can be permanently deformed without rupturing. The evaluation is made in accordance with the Field Book by forming a roll (wire) of soil at a water content where the maximum plasticity is expressed.

~~PRIMARY TREATMENT~~ Primary Treatment - The initial process to separate solids from the liquid, digest organic matter, and store digested solids through a period of detention and biological conditioning of liquid waste.

~~PROFESSIONAL SOIL CLASSIFIER~~ Professional Soil Classifier (“PSC”) - — A person with special knowledge of the physical, chemical, and biological sciences applicable to soils as natural bodies and of the methods and principles of soil classification as acquired by soils education and soil classification experience in the formation, morphology, description, and mapping of soils; is qualified to practice soil classifying; and who has been duly registered by the South Carolina State Board of Registration for professional soil classifiers.

~~PUBLIC ENTITY~~ Public Entity - — Any organizations such as a city, town county, municipality, or special purpose sewer district.

~~PUBLIC WATER SYSTEM~~ Public Water System - Any publicly or privately owned waterworks system that provides drinking water for human consumption, as defined in R.61-58, State Primary Drinking Water Regulations.

~~PUMP CHAMBER~~ Pump Chamber - A watertight, covered receptacle designed and constructed to receive and store the discharge from a septic tank until such time that the effluent is pumped to a final treatment and disposal site.

Pumping and Transporting Vehicle - A vehicle approved by the Department for the cleaning of onsite wastewater systems, self-contained toilets, and other sewage holding systems and the transporting of septage and sewage to an approved disposal site.

~~RECEPTOR~~ Receptor - Any water well or surface water of the state, including estuaries.

~~REDOX DEPLETIONS~~ Redox Depletions - Morphological features that are formed by the processes of reduction and translocation of iron and manganese oxides in ~~seasonally~~ saturated soils. These features may be revealed as spots, blotches, or streaks and are lighter shades of color compared with the dominant matrix color.

~~REDOXIMORPHIC FEATURES~~ Redoximorphic Features - Morphological features that are formed by the processes of reduction, translocation, and oxidation of iron and manganese oxides in ~~seasonally~~ saturated soils. These include redox concentrations, redox depletions, and reduced matrices.

~~REMOTE SUBSURFACE WASTEWATER INFILTRATION AREA~~ Remote Subsurface Wastewater Infiltration Area - A subsurface wastewater infiltration area that is not situated within the legal boundaries of the primary lot or tract that it serves.

REPAIR - Any work performed on an existing onsite wastewater system for the purposes of correcting a surface failure or other unauthorized discharge, enhancing system performance, relocating the entire system or system components, provided there are no changes in use that would impact the existing system.

~~REPAIR OR REPLACEMENT AREA~~ Repair or Replacement Area - ~~An area reserved for the installation of additional wastewater infiltration trenches. An area identified on the Permit to Construct reserved for the installation of additional wastewater infiltration trenches.~~

~~RESTRICTIVE HORIZON~~ Restrictive Horizon - A soil horizon that is capable of severely retarding the movement of groundwater or effluent, and may be brittle and cemented with iron, aluminum, silica, organic matter, or other compounds. Restrictive horizons may occur as fragipans, iron pans, organic pans, or shallow rock formations, and are recognized by their resistance in excavation and auger boring.

~~RESIN~~ Resin - Any number of commercially available polyester products used in the manufacture of fiberglass reinforced products which serve to contribute mechanical strength, determine chemical and thermal performance, and prevent abrasion of fibers, and which must be physically and/or chemically determined to be acceptable for the environment, ~~and~~ free from inert filler materials.

Revocation - The permanent withdrawal of rights and privileges granted by a license or an onsite wastewater system permit or approval, as applicable.

Rippable Rock - The rippability of rock material is a measure of its ability to be excavated with conventional excavation equipment (e.g., rubber-tired backhoe or mini excavator)

~~SAPROLITE~~ Saprolite - – Soft, friable, thoroughly decomposed rock that has formed in place by chemical weathering, retaining the fabric and structure of the parent rock, and being devoid of expansive clay. Unconsolidated saprolite can be dug using a hand auger or knife. Consolidated saprolite cannot be penetrated with a hand auger or similar tool, and must be dug with a backhoe or other powered equipment.

~~SEALANT~~ Sealant - A bonding agent specifically designed to bond joining sections of fiberglass reinforced plastic products to each other in such a manner so as to create a durable long lasting, watertight seal, which does not alter the structural integrity or strength of the two joined fiberglass products.

Self-Contained Toilet - A single or multiple-unit toilet and holding tank combination.

Septage - The mixture of solids and liquids removed during cleaning of a septic tank, grease trap, any other part of an onsite wastewater system, self-contained toilet, or other sewage holding system which receives domestic sewage; this includes the liquid, solid, and semi-solid materials which settle to the bottom of transport containers.

~~SEPTIC TANK~~ Septic Tank - A watertight, covered receptacle designed and constructed to receive the discharge of domestic wastewater from a building sewer, separate solids from the liquid, digest organic matter, store digested solids through a period of detention and biological conditioning of liquid waste, and allow the effluent to discharge for final treatment and disposal.

~~SERIAL DISTRIBUTION~~ Serial Distribution - – A method for effluent distribution on sloping terrain that utilizes drop boxes or earthen dams to affect total sequential flow from upper to lower wastewater infiltration trenches.

Sewage - Any liquid waste containing animal, vegetable, or chemical matter in suspension or solution from water closets, urinals, lavatories, bathtubs, laundry tubs or devices, floor drains, drinking fountains, or other water-using fixtures.

Site - The area or plot of land identified by a plat, deed, or other legal document specifying lot size and its boundaries that is submitted for evaluation by an applicant in an Onsite Wastewater System Application.

~~SITE EVALUATION~~ Site Evaluation — Evaluation of the soil, geology, zone of saturation, surface waters, topography, structures, and property lines of the proposed location of the onsite wastewater system. The evaluation can be conducted directly by certified Department personnel or the Department may conduct an evaluation through the review of information submitted by a Professional Soil Classifier licensed in the State of South Carolina.

Soils Report - A report prepared by a Professional Soil Classifier describing soil and site conditions for the purpose of designing an onsite wastewater system.

~~SOIL STRUCTURE~~ Soil Structure - – The aggregation of primary soil particles (i.e., sand, silt, and clay) into compound particles, or clusters of primary particles, which are separated from the adjoining aggregates by surfaces of weakness. In soils with platy structure, the aggregates are plate-like and overlap one another to severely impair permeability. A massive condition can occur in soils containing considerable amounts of clay when a portion of the colloidal material, including clay particles, tends to fill the pore spaces making the soil very dense.

~~SOIL TEXTURE~~ Soil Texture - – The relative proportions of the three soil separates (sand, silt, and clay) in a given sample of soil. The percentages of each separate are used to determine which class a particular



sample falls into by plotting the intersection of these three values on the United States Department of Agriculture (USDA) Natural Resource Conservation Service (USDA-NRCS) Textural Triangle.

~~SPECIALIZED ONSITE WASTEWATER SYSTEM DESIGN~~ Standard 610 - Specialized Onsite Wastewater System Design (less than 1500 GPD gpd) - An onsite wastewater system that is certified to function satisfactorily and in accordance with all requirements of R.61-56 by virtue of it having been designed by a Registered Professional Engineer (PE) licensed in the State of South Carolina with technical input from a Professional Soil Classifier licensed in the State of South Carolina. Such systems have limited application, and can only be utilized when the required engineering design, certification, and technical soils documentation have been provided to and accepted by the Department.

~~STANDARD~~ Standard - A group of requirements developed by the Department that specifies the minimum site conditions and design criteria necessary for the approval of a specific type of onsite wastewater system (i.e., ~~alternative system~~) ~~that differs from a conventional system~~. A standard may also address minimum design criteria for certain components of onsite wastewater systems as well as methodologies for determining system sizing.

~~STICKINESS~~ Stickiness - The capacity of soil to adhere to other objects. Stickiness is estimated in accordance with the Field Book at the moisture content that displays the greatest adherence when pressed between the thumb and forefinger.

~~SUBSURFACE WASTEWATER INFILTRATION AREA (DRAIN FIELD)~~ Subsurface Wastewater Infiltration Area (Drain Field) - A specific area where a network of wastewater infiltration trenches or other devices of sewage application are installed to provide the final treatment and disposal of effluent.

Surety Agreement - Through this agreement, the surety agrees to uphold - for the benefit of the obligee - the contractual promises (obligations) made by the principal if the principal fails to uphold its promises to the obligee.

Suspension - The temporary or indefinite withdrawal or cessation of rights and privileges granted by a license or onsite wastewater system permit or approval, as applicable.

Third-Party - A qualified person, as determined by the Department, that is independent of the parties involved.

~~ULTIMATE TENSILE STRENGTH~~ Ultimate Tensile Strength - A measure of the resistance of a material to longitudinal stress, measured by the minimum longitudinal stress required to rupture the material.

~~UPGRADE/EXPANSION~~ Upgrade/Expansion - Any work performed on an existing onsite wastewater system for the purposes of increasing the capacity of the system above its original design and/or accommodating wastes of a different character than was originally approved.

Wastewater Combustion System - A self-contained system for wastewater treatment that uses water as a medium for transport and storage. It treats and renders wastewater inert using maceration and incineration.

~~WASTEWATER INFILTRATION TRENCH~~ Wastewater Infiltration Trench - A trench installed in the naturally occurring soil that is utilized for the treatment and disposal of domestic wastewater. ~~A conventional trench is characterized by the following: (a) at least twenty three (23) inches in depth; (b) thirty six (36) inches in width; (c) filled with aggregate so that at least six (6) inches is beneath the distribution pipe, with at least five (5) inches on both sides of the pipe, and at least three (3) inches covering~~

the pipe; and (d) at least nine (9) inches of backfill. Other trench configurations are specified in the attached Appendices of Standards for Onsite Wastewater Systems.

~~WASTEWATER TREATMENT FACILITY~~ Wastewater Treatment Facility - – An accessible publicly or privately owned system of structures, equipment and related appurtenances ~~to~~ that treat, store, or manage wastewater.

~~ZONE OF SATURATION~~ Zone of Saturation - – Any zone in the soil profile that has soil water pressures that are zero or positive at some ~~times~~ time during the year. For the purpose of this regulation, the beginning of such a zone shall be utilized in determining all required vertical separations from the deepest point of effluent application. This zone, ~~therefore~~, shall be defined as the shallowest of those points at which either redox depletions of value four (4) or more and chroma two (2) or less appear or gleying is first observed; or, in the absence of other field identification methods, the maximum groundwater elevation as determined by wet season monitoring performed in accordance with criteria approved by the Department.

## B. REFERENCES 101.2. References

(1) The following statutes referenced in this Regulation are those in force on the effective date of this Regulation:

~~— (a) 1976 S.C. Code of Laws, Section 44-1-140(11), South Carolina Department of Health and Environmental Control (1976 Code as amended)~~

~~— (b) 1976 S.C. Code of Laws, Section 1-23-10 et seq., South Carolina Administrative Procedures Act (1976 Code as amended)~~

~~— (c) 1976 S.C. Code of Laws, Section 48-1-10 et seq., South Carolina Pollution Control Act (1976 S.C. Code as amended)~~

~~— (d) 1976 S.C. Code of Laws, Section 48-39-10 et seq., South Carolina Coastal Tidelands and Wetlands (1976 S.C. Code as amended)~~

~~— (e) Section 208, Federal Clean Water Act, 33 U.S.C. Section 1288~~

~~— (f) 1976 S.C. Code of Laws, Section 48-39-280 et seq., South Carolina Coastal Tidelands and Wetlands (1976 Code as amended)~~

~~— (g) 1976 S.C. Code of Laws, Section 44-55-1410 et seq., Water and Sewer Facilities in Counties (1976 S.C. Code as amended)~~

~~— (h) 1976 S.C. Code of Laws, Section 5-31-2010 et seq., Additional Powers of Municipalities as to Sewage Collection and Disposal (1976 S.C. Code as amended)~~

~~(2) The following Departmental Regulations referenced in this Regulation are those in force on the effective date of this Regulation:~~

~~— (a) Regulation 61-25, Retail Food Establishments~~

~~— (b) Regulation 30-1, Coastal Division Regulations~~

~~— (c) Regulation 61-9, Water Pollution Control Permits~~

~~— (d) Regulation 61-58, State Primary Drinking Water Regulations~~

~~— (e) Regulation 61-67, Standards for Wastewater Facility Construction~~

~~— (f) Regulation 61-68, Water Classification and Standards~~

~~— (g) Regulation 61-69, Classified Waters~~

(31) The following manufacturing and procedural standards referenced in this ~~Regulation~~ regulation are those in force on the effective date of this ~~Regulation~~ regulation:

(a) American Society of Agronomy (ASA)

- (b) American Society for Testing and Materials (ASTM) C
- (c) American Society for Testing and Materials (ASTM) D
- (d) Canadian Standard Association (CSA)
- (e) Crop Science Society of America (CSSA)
- (f) International Association of Plumbing and Mechanical Officials (IAPMO)
- (g) National Building Specification (NBS) Voluntary Product Standard PS 15-69
- (h) National Electrical Manufacturers Association (NEMA)
- (i) Soil Science Society of America (SSSA)

## **102 Onsite Wastewater System Site Evaluation and Fees**

### 102.1 Fees

(1) An applicant for a permit to construct an onsite wastewater system, nonwater-carried sewage treatment system, or wastewater combustion system shall, at the time an application for a permit to construct is submitted to the Department, pay to the Department the applicable site evaluation fee. Except as provided in 102.1(2), an applicant may choose from the available site evaluation processes and their associated fees as set forth in (a) through (e) below. Processing priority will vary depending on the application level chosen.

(a) **Level 1 Application** applicant shall pay a fee of one hundred fifty dollars (\$150.00) for the Department to evaluate a site of a proposed onsite wastewater system based on a Department-prepared soil evaluation and system layout. This fee shall include soil evaluation, system layout, and permit application processing, and review of all related documents for the issuance of a Permit to Construct and Approval to Operate. Processing priority will be given to Level 2, Level 3, and Level 4 applications over Level 1 applications.

(b) **Level 2 Application** applicant shall pay a fee of one hundred fifty dollars (\$150.00) for the Department to evaluate the site of a proposed onsite wastewater system based on review of a soil report provided by a third-party Professional Soil Classifier and a system layout prepared by an authorized third party. This fee shall include permit application processing and review of all related documents for the issuance of a Permit to Construct and Approval to Operate. Processing priority will be given to Level 4 applications over Level 2 applications. The following items shall be submitted to the Department to utilize this process:

- (i) Soil Report provided by a third-party Professional Soil Classifier.
- (ii) System layout provided by an authorized third party under Section 102.3.
- (iii) Certified as-built plans provided by a third-party Professional Engineer or Department designated final installation documentation from a Tier 3 Installer.

(c) **Level 3 Application** applicant shall pay a fee of three hundred fifty dollars (\$350.00) for the Department to evaluate the site of a proposed onsite wastewater system based on a soil report provided by a third-party Professional Soil Classifier and a Department-prepared system layout. This fee shall include system layout, permit application processing, and review of all related documents for the issuance of a Permit to Construct and Approval to Operate. Level 4 and Level 2 applications will be given priority over Level 3 applications.

(d) **Level 4 Application** applicant shall pay a fee of one thousand two hundred fifty dollars (\$1,250.00) for a maximally expedited evaluation of a site for a proposed onsite wastewater system based on a Department-prepared soil evaluation and system layout. This fee shall include soil evaluation, system

layout, permit application processing, and review of all related documents for the issuance of a Permit to Construct and Approval to Operate. Expedited permitting processes will be completed on a first-received, first-reviewed basis. Level 4 applications will be given first priority for processing.

(2) An application to construct and operate a system under System Standard 610 – *Specialized Onsite Wastewater System Design* use the Level 2 process and pay the associated fee. The applicant must provide to the Department a soil report provided from a third-party Professional Soil Classifier, a system layout prepared by a licensed third-party Professional Engineer, and certified as-built plans from the third-party Professional Engineer who prepared the system layout.

(3) Fees shall be paid prior to processing.

(4) Fees are non-refundable.

(5) See Appendix S and Appendix T for permitting levels associated with Nonwater-Carried Sewage Treatment Systems and Wastewater Combustion Systems.

### 102.2 Soil Evaluations

Soil evaluations shall only be conducted by a Professional Soil Classifier or a certified Department staff member.

### 102.3 System Layout

Only the following authorized individuals may prepare a system layout for an onsite wastewater system permit application in accordance with this regulation:

(1) A third-party licensed Professional Engineer; or

(2) A current Department employee who is certified to issue permits under R.61-56; or

(3) A former Department employee who worked for the Department for a period of no less than three (3) years and who was certified to issue permits under R.61-56 during that time; or

(4) An individual who worked in another state for a period of no less than five (5) years in a state or local onsite wastewater program and who issued no less than one hundred twenty (120) permits per year on average. This individual must successfully pass a certification exam through the Department.

### 102.4 Final Inspections and Approval

(1) Final inspections of onsite wastewater systems to determine compliance with a Department-issued Permit to Construct shall be conducted by certified Department staff except as follows:

(a) Tier 3 installers may self-inspect systems they install, except when Section 102.4(1)(b) applies.

(b) Third-party Professional Engineers must conduct final inspections on all systems they design.

(2) If the construction schedule for a Standard 610 specialized system installation is more than forty-eight (48) hours, the Department must be notified in advance of the beginning of construction.

(3) Documentation of system installations, including certified as-built plans where required, shall be submitted in a Department-approved format within two (2) business days of completing the system installation.

(4) The licensed system installer shall also sign a statement certifying that the OSWW system was installed as specified in the Department issued permit.

102.5 Quality Control

The Department will conduct random quality control evaluations on no less than three (3) percent of all third-party work submitted during the preceding fiscal year. This includes, but is not limited to, field reviews of soils reports, certified as-built plans, and actual installations for licensed Tier 3 installers, Professional Soil Classifiers, and Professional Engineers.

102.6 Application and Fee Schedule

Applicants shall comply with the following for each application level, consistent with 102.1 through 102.4 above:

<b><u>Application Schedule</u></b>	<b><u>Soil Evaluation Shall be Conducted By:</u></b>	<b><u>System Layout Shall be Developed By:</u></b>	<b><u>Final Inspection Shall be Conducted By:</u></b>	<b><u>Fee</u></b>
<b><u>Level 1</u></b>	<u>Department</u>	<u>Department</u>	<u>Tier 3 Installer or Department</u>	<u>\$150.00</u>
<b><u>Level 2</u></b>	<u>PSC</u>	<u>Person authorized under 102.3</u>	<u>PE, Tier 3 Installer, or Department</u>	<u>\$150.00</u>
<b><u>Level 3</u></b>	<u>PSC</u>	<u>Department</u>	<u>Tier 3 Installer or Department</u>	<u>\$350.00</u>
<b><u>Level 4</u></b>	<u>Department</u>	<u>Department</u>	<u>Tier 3 Installer or Department</u>	<u>\$1,250.00</u>

~~102 GENERAL~~ **103 Onsite Wastewater Systems**

103.1 General

~~102.1~~ (1) Each dwelling unit, building, business, or other structure occupied for more than two (2) hours per day shall be provided with an approved method for the treatment and disposal of domestic wastewater.

~~102.2~~ (2) It shall be the responsibility of the property owner to ensure that a permit to construct and operate any new, upgraded, or expanded onsite wastewater system, nonwater-carried sewage treatment system, or

wastewater combustion system is obtained from the Department prior to construction and operation of the system.

~~102.3~~ (3) No person shall begin construction of a ~~building dwelling, business, or other structure~~ to be served by an onsite wastewater system, nonwater-carried sewage treatment system, or wastewater combustion system until a permit to construct and operate such a system is issued by the Department. Mobile or modular structures intended for occupancy shall not be moved onto the site until the permit to construct and operate an onsite wastewater system has been issued.

~~102.4~~ (4) The permit holder shall be required to properly operate and maintain in good working order, and operate as efficiently as possible, all facilities and systems which are installed pursuant to the permit and to comply with all terms and conditions of the permit.

~~102.5~~ (5) An onsite wastewater system serving more than one (1) piece of deeded property shall be considered as a community or cluster collection and treatment system and shall comply with the following:

(1) (a) A permit activity will not occur that is inconsistent with a plan or plan amendment approved under section 208(b) of the Clean Water Act unless the Department finds such variance necessary to protect the public's health, safety, and welfare.

(2) (b) ~~Alf a public entity shall owns the system and, the entity shall be responsible for the operation, maintenance, and replacement of all components unless otherwise approved by the Department. The Department may consider a request from a private entity or person; however, such proposals must be evaluated on a case-by-case basis. The Department will evaluate the capability of long-term, reliable system operation in its evaluation of a permit request.~~

(3) (c) If the project is owned by a private entity or person, the Department shall require financial assurances for the operation, maintenance, and replacement of the tank(s) and subsurface wastewater infiltration area system and relevant collection/pumping components.

(4) (d) Sufficient area meeting the minimum requirements for large onsite wastewater systems shall be provided for at least one hundred (100) percent repair or replacement of the primary subsurface wastewater infiltration area.

(5) (e) The collection sewer and pumping portions of a community onsite wastewater system shall receive a separate Construction Permit under ~~R. 61-67.300~~, R.61-67.300, Standards for Wastewater Facility Construction.

~~102.6~~ When the actual or estimated peak sewage flow will exceed fifteen hundred (1500) gallons per day, the Department may require that the design of the onsite wastewater system be prepared by a Registered Professional Engineer licensed in the State of South Carolina. A Registered Professional Engineer licensed in the State of South Carolina may also design all onsite wastewater systems where the sewage flow will be less than fifteen hundred (1500) gallons per day. These designs shall include the Soils Report conducted by certified Department personnel or submitted by a Professional Soil Classifier licensed in the State of South Carolina and shall satisfy requirements of Regulation 61-56, Section 415, Appendix O — System — Standard 610 — Specialized Onsite System Designs.

~~102.7~~ 103.2 Large (greater than 1500\_gpd) and community onsite wastewater systems incorporating advanced treatment methods, including but not limited to aerobic pre-treatment, lagoons, surface or subsurface drip irrigation, low pressure pipe distribution and other maintenance intensive methods, shall be

required to obtain a Land Application Permit under ~~R. 61-9.505~~R.61-9.505, Water Pollution Control Permits.

~~102.8~~ 103.3 Facilities that generate industrial process or any other non-domestic wastewater shall not be granted a permit under this regulation unless the Department determines that the proposed discharge would not pose a significant environmental risk. In such a determination, the Department would assess the risk to public health and/or groundwater contamination regardless of whether or not the wastewater ~~were~~ is to be discharged continuously or intermittently to the onsite wastewater system. Plumbing appurtenances that facilitate the transport of such wastewater, including floor drains, trench drains, utility sinks, equipment drains, or any other conduit shall not be installed in facilities served by onsite wastewater systems unless specifically approved by the Department as a result of the above-described determination.

#### ~~102.9~~ 103.4 Campgrounds

(1) Onsite wastewater systems serving campgrounds shall comply with all applicable requirements of this regulation. Such campgrounds shall be provided with adequate toilet and bathing facilities, except in those cases where all campsites are furnished with individual sewer service connections, and each site is exclusively designated for use by camping units equipped to access such connections.

(2) Individual sewer service connections shall be part of an approved sewage collection system and shall be equipped with removable, tight fitting covers.

(3) Where individual sewer service connections are not furnished at all campsites, an approved sanitary dump station(s) shall be provided at a convenient location(s) within the campground at the ratio of one dump station per one hundred (100) ~~unsewered~~ campsites or fractions thereof.

(a) A dump station shall consist of one or more trapped four inch sewer risers surrounded by a concrete apron having a diameter of at least two (2) feet and sloped to drain. Sewer risers must be equipped with removable, tight fitting covers.

(b) Each dump station shall be equipped with pressurized water to be used for washing the concrete apron. The water outlet shall be protected from back siphonage by a vacuum breaker installed at its highest point, or by other approved means. A sign shall be placed at this water outlet stating: THIS WATER IS FOR CLEANING PURPOSES ONLY.

### ~~103 APPLICATION, PERMIT, APPROVAL~~ **104 Application and Permit**

#### ~~103.1~~ 104.1 Application

(1) The applicant shall furnish, ~~on the application form provided~~ in a format as identified by the Department, correct information necessary for determining the feasibility of an onsite wastewater system.

(2) A boundary plat, deed or other legal document specifying the lot size ~~and its boundaries~~ shall be furnished by the applicant. The Department may require a legal description that specifies lot boundary lengths. When a dwelling or facility is to be served by a remote subsurface wastewater infiltration area, the applicant must provide appropriate easement(s). An appropriate easement must allow ingress and egress for construction, operation, maintenance, replacement and repair and must run with the land.

(3) Soil boring descriptions, backhoe pits, and soils classifications from specifically identified locations, including other tests or information, shall be required when deemed necessary by the Department.

(4) Before a site evaluation of the lot is performed by the Department, the applicant may be required to: clear and mark pertinent property boundary lines and corners; post an identification marker in the front center of the lot; place stakes at the corners of the proposed building; mark the proposed point of stub-out and septic tank; locate the proposed or existing well location; and identify the proposed location of any additional structures or facilities on the property that may influence the placement and configuration of the onsite wastewater system. ~~Also, the~~ The applicant may be required to clear underbrush from the property in order to facilitate the evaluation.

(5) The Department will not issue a permit if it determines that site conditions are unsuitable for the system layout or permit requested or if issuance of the permit would otherwise be inconsistent with the requirements of this regulation.

#### ~~103.2~~ 104.2 Permit

(1) It shall be unlawful to construct, upgrade, expand, or operate an onsite wastewater system, nonwater-carried sewage treatment system, or wastewater combustion system unless the Department has issued a permit for the specific construction and operation proposed. The system shall be constructed and operated in accordance with the permit, and the Department must authorize any changes prior to the construction and operation of the system. The applicant shall be required to make a written request or ~~submit a new application if the~~ for permit modifications require another site evaluation. The applicant shall submit a new application with applicable fee for permit modifications involving an additional site evaluation. ~~The Department may also require a permit for the repair of an onsite wastewater system when deemed necessary.~~

(2) The ~~onsite wastewater~~ permitted system shall be constructed and operated according to the specifications and conditions of the permit, and in compliance with this regulation.

~~(3) In the case of repairs to existing onsite wastewater systems, the Department may authorize the best possible method of repair that, in the opinion of Department staff, may improve the operation of the system, regardless of site conditions.~~

~~(4)~~ (3) Permits issued after the effective date of this regulation shall remain valid for a period of five (5) years from the date of issuance, provided the physical character of the property has not changed and the conditions of the original permit can be met. Exceptions may be granted for those permits addressed by other statutes.

#### ~~103.3~~ Approval

~~(1) Any repair, extension or alteration for which a permit has been issued and all newly constructed onsite wastewater systems may be inspected in accordance with S.C. Code Section 44-55-825.~~

~~(2) The licensed system contractor shall also sign a statement that the onsite wastewater system was installed as specified in the Department issued permit.~~

### ~~200~~ 200 ~~MINIMUM SITE CONDITIONS~~ **Minimum Site Conditions for Onsite Wastewater System**

200.1 Soil texture, depth of soil to restrictive horizons, and depth to the zone of saturation shall meet minimum standards approved by the Department. These characteristics shall be determined using accepted methodologies in the field of soil science.



200.2 Soils exhibiting massive or platy structure, and soils which have been identified as having substantial amounts of expansible layer clay minerals or smectites, are unsuitable for onsite wastewater systems.

200.3 Where the estimated peak sewage flow will not exceed fifteen hundred (1500) gpd, the minimum vertical separation between the deepest point of effluent application and the zone of saturation shall be at least six (6) inches.

200.4 Where the estimated peak sewage flow will exceed fifteen hundred (1500) gpd, the depth to the zone of saturation shall be at least thirty six (36) inches below the naturally occurring soil surface, and at least six (6) inches below the deepest point of effluent application.

200.5 Depth to rock and other restrictive horizons shall be greater than twelve (12) inches below the deepest point of effluent application.

200.6 The area of the lot or plot of ground where the onsite wastewater system is to be installed shall be of sufficient size so that no part of the system, excluding solid pipes, will be:

- (1) Within five (5) linear feet of a building, or under a driveway or parking area;
- (2) Within seventy-five (75) linear feet of a private well (~~less than 1500 gpd sewage flow~~), ~~one hundred (100) linear feet of a receptor (greater than 1500 gpd sewage flow)~~, and ~~within the Department's established minimum distance from a public well~~;
- (3) Within one hundred (100) linear feet of a public well;
- (4) Within seventy-five (75) linear feet of the delineated critical area line (tidal waters of coastal waters and tidelands critical areas) as determined by the Department's coastal division; or within seventy-five (75) linear feet of the mean high water (within the banks) elevation (non-tidal waters, beach/dune systems and beach critical areas) of an impounded or natural body of water, including streams, ~~and canals~~, and retention ponds;
- (5) Within ten (10) feet of upslope and twenty-five (25) feet of down slope curtain drains;
- (6) Within twenty-five (25) feet of a drainage ditch or stormwater treatment system including any detention ponds (determined by maximum water elevation);
- (7) Within fifteen (15) feet of piped drainage ditches;
- ~~(7) (8)~~ Within fifteen (15) feet of the top of the slope of embankments or cuts of two (2) feet or more vertical height when any part of the wastewater infiltration trench is to be placed higher in elevation than the invert of the cut or embankment;
- ~~(8) (9)~~ Within five (5) feet of a property line.
- ~~(9) (10)~~ Greater protective offsets shall be required when utilizing certain alternative system standards contained within this ~~Regulation~~ regulation.

200.7 In addition to the minimum space required in Section 200.6, minimum repair area shall be set aside as follows:

(1) Any new site meeting the minimum design criteria for an onsite wastewater system shall have a usable repair or replacement area equivalent to at least fifty (50) percent of the size of the original system. Where community onsite wastewater systems are utilized, there must be at least one hundred (100) percent repair or replacement area. ~~This area cannot be covered with structures or impervious materials.~~

(2) Usable repair or replacement area shall be demonstrated to include suitable soil conditions, and shall be free of impervious materials, buildings, or other improvements, setbacks, easements, and other encroachments that would prevent system construction. The undisturbed area between the wastewater infiltration trenches shall not be credited towards this requirement.

200.8 Multiple, individually owned remote subsurface wastewater infiltration areas may be considered for mass installation in a defined area where the wastewater infiltration trenches will be adjacently located to each other, provided that the combined peak wastewater loading is less than fifteen hundred (1500) gpd. In such cases, each subsurface wastewater infiltration area plot shall be sized such that there is sufficient area for one hundred (100) percent subsurface wastewater infiltration area replacement. Each plot shall be deeded, with all appropriate easements, as a lot in conjunction with the specific unit that it serves, and required protective offsets, as described in Section 200.6, shall apply to each individual remote subsurface wastewater infiltration area. A plan shall be prepared by a Registered Professional Engineer licensed in the State of South Carolina that illustrates the overall plan; specifies the route and identification of effluent sewers and/or force mains; specifies the entity responsible for perpetual maintenance of the sewer lines and mass subsurface wastewater infiltration area; specifies the configuration and identification of the individual subsurface wastewater infiltration area parcels; and specifies the manner in which ingress and egress will be provided to the individual subsurface wastewater infiltration area parcels. When the combined peak wastewater loading of the adjacently loading subsurface wastewater infiltration area will exceed fifteen hundred (1500) gpd, the project shall be considered as a public (community) collection and treatment system, ~~then~~ and the onsite wastewater system must comply with the requirements in Section ~~102.5~~ 103.1(5).

## ~~201 MINIMUM REQUIREMENTS FOR PRIMARY TREATMENT~~ **201 Minimum Requirements for Onsite Wastewater System Primary Treatment**

### 201.1 Septic Tanks

(1) All persons or firms manufacturing septic tanks for use in South Carolina shall submit detailed plans for each size tank to the Department, and shall receive written approval for such tanks prior to their installation in the state.

(2) The design and construction of each septic tank shall be in accordance with minimum standards contained within this ~~Regulation~~ regulation.

(3) No septic tank shall be installed which has a net liquid capacity of less than one thousand (1000) gallons. Such tanks shall be sufficient to serve dwellings of four (4) bedrooms or less. Two hundred fifty (250) gallons additional capacity shall be required for each bedroom over four (4).

(4) When multiple dwellings, ~~including condominiums, apartments, and mobile homes,~~ share a common onsite wastewater system, each dwelling unit shall either have its own properly sized septic tank, or it must discharge to a larger tank(s) that provides the combined total of the minimum septic tank capacities required for each contributing unit. Exception may be granted when a public entity, or private entity with financial assurances, is approved by the Department to provide operation and maintenance of the system. In such cases, the formula in Section 201.1(5) may be considered.

(5) Septic tanks serving establishments other than individual dwellings shall be sized according to actual peak flow data, when available, or by estimates of peak sewage flow, as set forth in standards established by the Department. For those septic tanks receiving peak flows less than fifteen hundred (1500) gpd, the net liquid capacity shall be calculated by multiplying 1.5 times the peak flow expressed in ~~gallons per day (gpd)~~. For those septic tanks receiving peak flows between fifteen hundred (1500) and forty five hundred (4500) gpd, the net liquid capacity shall be calculated as follows:

$$\text{Volume (V)} = 1125 \text{ gal. plus } (0.75 \times \text{Peak Flow(gpd)}).$$

For those septic tanks receiving peak flows in excess of forty five hundred (4500) gpd, the net liquid capacity shall be at least equal to the peak flow:

$$\text{Volume (V)} = \text{Peak Flow (gpd)}$$

(6) The minimum liquid capacity requirements shall be met by the use of a single septic tank or two or more tanks installed in series. Septic tanks joined in series shall be interconnected by an upper effluent pipe(s) with a minimum diameter of four (4) inches and a lower sludge pipe(s) with a minimum diameter of twelve (12) inches. The upper connection(s) shall be installed level from tank to tank, and the lower sludge pipe connection(s) shall be installed level and shall be placed twelve (12) inches above the bottoms of the tanks. The lower sludge pipe connection(s) can be eliminated if the first tank in series contains at least two-thirds of the total required liquid capacity. There shall be no more than two (2) inches of fall from the inlet invert of the first tank to the outlet invert of the last tank in series.

## 201.2 Grease Traps

(1) Any new food service facilities permitted under ~~R. 61-25~~ R.61-25 and served by an onsite wastewater system that is permitted after the effective date of this regulation shall be required to have a properly sized grease trap. This requirement ~~shall~~ may also apply to new facilities not requiring a food service permit under ~~R. 61-25~~ R.61-25, ~~where cooking operations are performed~~. Exception may be granted in cases where a permitted retail food service establishment performs limited food preparation and/or cooking, ~~is permitted but does not perform any cooking or food preparation operations~~.

~~(2) Existing food service establishments permitted under R. 61-25~~ R.61-25 prior to the effective date of this regulation shall not be required to immediately comply with this section, provided the facility does not experience an onsite wastewater system malfunction. ~~Those existing establishments that experience a future malfunction as a result of problems associated with the accumulation of grease shall be required to comply with all portions of this section. Also, food service facilities that were permitted prior to the effective date of this regulation, were closed, and then reopened at any time thereafter, provided the facility was not experiencing a malfunction prior to closure and the original peak design flow will not be exceeded, shall not be required to immediately comply with this section provided the facility does not experience an onsite wastewater system malfunction. Any existing food service establishment which does not have a grease trap, but experiences an onsite wastewater malfunction as a result of grease accumulation, shall be required to immediately comply with all portions of this section.~~

(3) Any food service facility requiring a grease trap shall provide two separate plumbing stub-outs, one serving the food preparation area and the other serving the restrooms. The stub-out from the restrooms shall discharge directly into the main building septic tank. The stub-out from the food preparation area shall discharge directly into the grease trap with the effluent then directed to the main building septic tank. In order to enhance grease separation while the liquids are hot, the grease trap shall be placed as close as possible to the source of wastewater. Garbage grinders shall not be allowed to discharge to such systems.

(4) All grease traps must be directly accessible from the surface, and must be equipped with an extended outlet sanitary tee terminating six (6) to twelve (12) inches above the tank bottom. The minimum access opening shall be eighteen (18) inches in diameter.

(5) All grease traps serving facilities from which the peak sewage flow exceeds fifteen hundred (1500) gpd shall either be dual chambered or individual tanks in series. If dual chambered, both the dividing wall and the second chamber must be equipped with a sanitary tee terminating six (6) to twelve (12) inches above the tank bottom.

(6) It shall be the responsibility of the owner/manager to ensure that the grease trap(s) is cleaned by a licensed septage pumper at frequent intervals to prevent the carryover of grease into other parts of the onsite wastewater system.

(7) Determination of Minimum Net Liquid Capacity

(a) No grease trap used as part of an onsite wastewater system shall have a net liquid capacity of less than one thousand (1000) gallons. ~~Also, commercial~~ Commercial interior-type grease interceptors shall not be utilized in lieu of a properly sized exterior grease trap.

(b) Minimum net liquid capacities of grease traps shall be determined as follows:

$NLC = GPD \times LF \times RF$ , where

NLC = Net Liquid Capacity of Grease Trap (gallons)

GPD = Total Maximum Estimated Sewage Flow (gpd)

LF = Loading Factor (the approximate portion of the total maximum daily flow generated in food preparation areas)

0.3 - Schools and Other Institutions

0.4 - Restaurants

0.5 - Retail Food Stores

RF = Minimum Retention and Storage Factor of 2.5 for Onsite Wastewater Systems

### 201.3 Other Primary Treatment Methods

The Department, at its discretion, may consider other methods of primary treatment where conditions are warranted.

## ~~202 MINIMUM REQUIREMENTS FOR FINAL TREATMENT AND DISPOSAL SYSTEMS~~ **202** **Minimum Requirements for Onsite Wastewater System Final Treatment and Disposal S**

### 202.1 General

(1) All pipe utilized in onsite wastewater systems shall meet applicable ASTM standards. All piping utilized in the connection of a septic tank to a subsurface wastewater infiltration area, including that which is utilized in the connection of adjacent wastewater infiltration trenches, whether they be level or serially fed, shall be non-perforated Schedule 40 PVC pipe. Such pipe, excluding force mains, shall be a minimum of three (3) inches in diameter. The connecting pipe shall not be surrounded by aggregate.

(2) At least seven (7) feet of undisturbed earth shall exist between wastewater infiltration trenches.

(3) The aggregate used in onsite wastewater systems shall be a material approved by the Department, and shall range in size from one-half (1/2) inch to two and one-half (2 1/2) inches. Fines shall be prohibited.

Tire chips shall range in size from one-half (1/2) inch to four (4) inches in size, and wire strands shall not protrude more than one-half (1/2) inch from the sides.

(4) Drop boxes shall be utilized when deemed necessary by the Department. When required, they shall be surrounded and stabilized by at least two (2) feet of undisturbed or manually compacted earth, and the wastewater infiltration trenches shall be fed with non-perforated Schedule 40 PVC pipe. The invert of the drop box overflow pipe shall be at the same elevation as the top of the aggregate in the trenches fed by that box, and the top of the aggregate shall be level throughout the trench run. Other methods that affect serial distribution shall also overflow at the same elevation as the top of the aggregate.

(5) There shall be at least two (2) feet of earthen buffer between the septic tank and all portions of adjacent wastewater infiltration trenches. Where gravity flow is utilized, the invert elevation of the septic tank outlet shall be at the same elevation or higher than the top of the aggregate in the highest placed wastewater infiltration trench.

(6) To ensure proper operation and protection of onsite wastewater systems, the Department may require individual or combined installation of drainage swales, curtain or interceptor drains, protective barriers, or protective ground cover. Final approval of the permit may be withheld until such time as these improvements are completed.

(7) The bottom of each wastewater infiltration trench, including the distribution pipe contained within, shall be as level as possible, with an elevation differential not to exceed two (2) inches throughout the trench run.

(8) The required number, length, and configuration of wastewater infiltration trenches shall be determined by the Department, and shall be based upon the Standard for Determining Peak Sewage Flow Rates (~~Appendix R~~) (Section 501, Peak Sewage Flow Rate Standard) from Commercial and Recreational Establishments in conjunction with the ~~Long Term~~ Long Term Acceptance Rate Standard for Onsite Wastewater Systems (~~Appendix Q~~) (Section 500, Long Term Acceptance Rate Standard for Onsite Wastewater Systems). All systems shall be sized based upon the most hydraulically limiting, naturally occurring soil texture from the ground surface to twelve (12) inches below the bottom of the proposed wastewater infiltration trenches.

(9) The aggregate over the distribution pipe shall be covered with a strong, untreated pervious material to prevent infiltration of backfill material.

### ~~203 CONSTRUCTION CRITERIA~~ **203 Onsite Wastewater System Construction Criteria**

203.1 On sloping terrain, wastewater infiltration trenches shall be installed perpendicular to the direction of slope and parallel to the contours of the land.

203.2 Where deemed necessary by the Department, all required site alterations (swales, fill, shaping, etc.) shall be done prior to permitting the installation of the onsite wastewater system.

203.3 The area in which the onsite wastewater system is to be located shall be protected from surface water and roof or downspout drainage by the installation of drainage swales and small amounts of fill to achieve positive surface drainage.

203.4 Gross amounts of dirt, mud, and debris shall be removed from the septic tank before backfilling. All backfilling around the tank shall be tamped to facilitate stabilization.

203.5 If septic tank lids are of multi-part, slab-type construction, all joints shall be caulked or covered with heavy roofing paper or similar material.

203.6 All septic tanks of two-piece construction joined by tongue and groove shall be sealed with either bituminous mastic or other watertight caulking material placed in the groove in such quantity that the sealant is clearly visible around the entire tank after the two pieces are joined.

203.7 When effluent pumping is required, all components of the pumping system shall adhere to standards contained within this ~~Regulation~~ regulation.

203.8 The Department may restrict, delay, or prohibit the installation or final approval of any onsite wastewater system when adverse soil or site conditions exist. These may include, but not be limited to, wet soil conditions in textural ~~classes~~ Class III and Class IV as described in the ~~Long-Term~~ Long Term Acceptance Rate Standard for Onsite Wastewater Systems approved by the Department.

## ~~204 EVALUATION OF ALTERNATIVE INFILTRATION TRENCH PRODUCTS~~ **204 Evaluation of Alternative Infiltration Trench Products**

The Department shall be responsible for the evaluation and approval of alternative infiltration trench products prior to their use in the State, unless otherwise regulated by statute. This evaluation shall include a review of available research data; a review of parameters relating to structure, geometry, and volume; and the establishment of required equivalency values for comparing the product to a conventional wastewater infiltration trench.

### 204.1 Application

(1) All requests for approval of alternative infiltration trench products must be submitted in writing to the Department, and must include the following:

- (a) Complete description of the product and its intended use.
- (b) Complete listing of materials used in the construction of the product, including specifications.
- (c) Copies of all available literature pertaining to the product, and a listing of all appropriate reference materials.
- (d) Copies of any and all available research, testing, and monitoring data, to include records of performance and/or prior experience in actual field conditions.

(2) The Department will review the application, and may seek other information, including additional evaluations.

### 204.2 Equivalency Value ~~For~~ for Infiltrative Surface

(1) The total infiltrative surface area surrounding the sides and bottom of a conventional wastewater infiltration trench (i.e., 5.33 sq.ft./lin.ft.) shall serve as the basis for all geometric comparisons to alternative infiltration trench products.

(2) The effective infiltrative surface area of a conventional trench shall include the total of both rectangular sidewalls, beginning at the top of the aggregate and extending to the trench bottom, in addition

to the width of the trench bottom. Similarly, the effective infiltrative surface area of a product shall include the total of both immediately adjacent, rectangular sidewalls, beginning at the top of louvers, slits, holes or similar orifices, in addition to the rectangular width of the trench immediately beneath the product.

(3) The equivalency value (E) for any given product is determined by comparing the total effective surface area of the product, as defined above, with that of a conventional wastewater infiltration trench as follows:

(a) Total Infiltrative Surface Area for One Foot of Conventional Trench:

$$\text{Trench Sidewalls} = 2 \times (1.16\text{ft.H} \times 1.0\text{ft.L}) = 2.33 \text{ sq.ft./lin.ft.}$$

$$\text{Trench Bottom} = 1 \times (3\text{ft.W} \times 1\text{ft.L}) = 3.0 \text{ sq.ft./lin.ft.}$$

$$\text{Total Infiltrative Surface Area} = 5.33 \text{ sq.ft./lin.ft.}$$

(b) Equivalency Value (E) Shall Be Computed As Follows:

$$E = 5.33 \text{ sq.ft./ft} \div \text{Sum of Three Rectangular Interfaces Immediately Adjacent to Product (sq.ft./ft.)}$$

(c) The Required Total Length of the Product Shall Be Calculated As Follows:

Length of Product (L) = E x Length of Conventional 36 in. Wide Trenches Required ~~By~~ by DHEC Regulations and Standards

204.3 Other parameters to be evaluated for alternative infiltration trench products may include the following:

(1) Structural Integrity - Products must be of sound construction and able to adequately withstand the normal pressures and ~~stressed~~ stresses associated with installation and use.

(2) Inertness - No product can be approved unless it will remain relatively unaffected for extended periods of time while in contact with typical domestic wastewater.

(3) Storage Volume - The effluent storage capacity of a product must closely approximate or exceed that of a comparable conventional system.

(4) Maintenance of Permeable Interfaces - A product shall have a direct interface with the effective infiltrative surface (undisturbed natural soil) or, if backfill is required, backfill material shall not create a permeability barrier and shall not hinder the downward or horizontal flow of effluent into the undisturbed natural soil.

(5) The unique characteristics of a given product may warrant the evaluation of other parameters not specifically mentioned in this section of the regulation.

(6) The design, construction, or installation methods used with any product shall not conflict nor violate any other requirements established by the Department.

#### 204.4 Approval ~~For~~ for General Use

If warranted, the Department will issue a letter of approval for general use of the alternative infiltration trench product in accordance with equivalency values and other requirements determined herein. At least nine (9) inches of backfill soil cover is required ~~unless a lesser amount is approved by the Department.~~

~~300 WASTEWATER TREATMENT FACILITY ACCESSIBILITY~~ **300 Wastewater Treatment Facility Accessibility**

300.1 Permits for new onsite wastewater systems shall not be issued where a wastewater treatment facility is accessible for connection.

300.2 Repairs to or replacement of failing onsite wastewater systems shall not be allowed where a wastewater treatment facility is accessible for connection.

~~301 DISCHARGE OF WASTE~~ **301 Discharge of Waste**

No septic tank effluent or domestic wastewater or sewage shall be discharged to the surface of the ground or into any stream or body of water in South Carolina without an appropriate permit from the Department.

~~302 ENFORCEMENT PROVISIONS~~

~~—(1) This regulation is issued under the authority of Section 44-1-140(11) of the 1976 Code of Laws, as amended, and Section 48-1-10 et seq. of the 1976 Code of Laws, as amended. It shall be enforced in accordance with interpretations and public health reasons approved by the Department.~~

~~—(2) The Department may temporarily suspend a permit for a violation of this regulation.~~

~~—(3) The Department may revoke a permit for a violation of this regulation. The Department will revoke a permit when:~~

~~—(a) the onsite wastewater system is malfunctioning and sewage is discharging to the ground or the groundwater, the holder of the permit has received notice that the system is malfunctioning, the Department has given notice that repairs must be made within a reasonable period of time, the holder of the permit has not made the repairs, and the system continues to discharge sewage to the ground or the groundwater; or~~

~~—(b) the onsite wastewater system is malfunctioning and sewage is discharging to the ground or the groundwater, the holder of the permit has received notice that the system is malfunctioning, the Department has given notice that a wastewater treatment facility is accessible for connection.~~

~~—(4) Following revocation under R.61-56.302.3.a, the holder of the revoked permit can obtain a repair permit and make the necessary repairs to the system. After the Department approves the repairs pursuant to Section 103.3 of this regulation, the holder of the permit will operate the onsite wastewater system under the terms of the new permit.~~

~~—(5) In addition to the authority to suspend and revoke permits, the Department may seek enforcement and issue civil penalties in accordance with SC Code Ann. Sections 44-1-150 and 48-1-320, 330, and 340. The Department shall have the authority to assess and suspend civil penalties if the violations of this regulation are corrected in a period of time established by the Department.~~

~~—(6) A Department decision involving the issuance, denial, renewal, modification, suspension, or revocation of a permit may be appealed by an affected person with standing pursuant to applicable law, including S.C. Code Title 44, Chapter 1 and Title 1, Chapter 23. Any person to whom an order or enforcement letter is issued may appeal it pursuant to applicable law, including S.C. Code Title 44, Chapter 1 and Title 1, Chapter 23.~~



### ~~303 REPEAL AND DATE OF EFFECT~~

~~This regulation shall become effective as provided in Section 12310 et seq. of the 1976 Code of Laws of South Carolina, as amended, and shall repeal Department of Health and Environmental Control R. 6156 of the Code of Laws of South Carolina, 1976; except that, Sections 200.6(2) and 200.6(4) shall become effective on January 1, 2009, and existing Sections V.E(b) and (c) shall remain in effect until that date.~~

### ~~304 CHANGES IN USE THAT IMPACT EXISTING ONSITE WASTEWATER SYSTEMS~~ **302** **Changes in Use That Impact Existing Onsite Wastewater Systems**

If the use of a dwelling or facility is changed such that additions or alterations are proposed which increase wastewater flow, change wastewater characteristics, or compromise the integrity or function of the system, the onsite wastewater system shall be brought into full compliance with this regulation. Alterations that change the wastewater characteristics or increase wastewater flow will require the owner to submit an application ~~apply for~~ and receive ~~an~~ approval for the upgrade/expansion prior to any alterations.

### ~~305 SEVERABILITY CLAUSE~~

~~Should any section, paragraph, sentence, clause or phrase of this regulation be declared unconstitutional or invalid for any reason, the remainder of this regulation shall not be affected thereby.~~

### ~~400 Appendices OF STANDARDS FOR ONSITE WASTEWATER SYSTEMS~~ **400 Appendices of** **Standards for Permitted Systems**

#### **Appendix A - System Standard 100/101 - Conventional with 14-Inch Aggregate Depth**

##### (1) Site/Permitting Requirements

(a) The depth to the zone of saturation (ZOS) must be at least twenty-nine (29) inches below the naturally occurring soil surface and at least six (6) inches below the bottom of the proposed wastewater infiltration trenches at the deepest point of effluent application.

(b) The depth to any restrictive horizon must be greater than twelve (12) inches below the bottom of the proposed wastewater infiltration trenches at the deepest point of effluent application.

(c) The long term acceptance rate for system sizing shall be based upon the most hydraulically limiting naturally occurring soil texture from the ground surface to twelve (12) inches below the bottom of the proposed wastewater infiltration trenches.

(d) There shall be a replacement area equivalent to at least fifty (50) percent in size of the original system area held in reserve for system repair. This area shall have a suitable configuration and shall meet the minimum soil and site conditions of R.61-56.

(e) This system must not be used on slightly sloping sites that require serial distribution unless it can be demonstrated that the entire wastewater infiltration trench installation (i.e., side wall to side wall and end to end) can meet the required textural limitations and the required offsets to the zone of saturation and restrictive horizons.

##### (2) Installation Requirements

(a) The wastewater infiltration trench aggregate shall be fourteen (14) inches in depth and shall be placed so as to provide six (6) inches of aggregate below the pipe, five (5) inches beside the pipe, and three (3) inches above the pipe. The aggregate shall be covered with at least nine (9) inches of soil.

(b) The wastewater infiltration trench width shall be thirty-six (36) inches.

(c) Where gravity flow from the septic tank to the subsurface wastewater infiltration area is utilized, the invert elevation of the septic tank outlet shall be installed at an elevation at least equal to or higher than the top of the aggregate in the highest wastewater infiltration trench(es).

(d) All tree and brush removal shall be done in a manner that minimizes the disturbance or loss of naturally occurring soil.

### (3) Final Landscaping and Drainage

(a) Installation of drainage swales, ditches, curtain drains, and rain gutters may be required to divert or intercept water away from the onsite wastewater system location to a positive outfall. The septic tank and subsurface wastewater infiltration area shall be backfilled and shaped to promote surface water runoff.

(b) A barrier to preclude parking and vehicular traffic over the system area may be required.

(c) Following final landscaping, seeding, or sodding may be required to prevent erosion.

(d) Final approval shall be withheld until all landscaping and drainage improvements have been satisfactorily completed.

SOUTH CAROLINA DEPARTMENT OF HEALTH AND ENVIRONMENTAL CONTROL  
BUREAU OF ENVIRONMENTAL HEALTH SERVICES

CONVENTIONAL STANDARD  
WITH FOURTEEN (14) INCH AGGREGATE DEPTH  
PROGRAM 360/ CODE 100 / CODE 101 IF PUMPED

TYPICAL DESIGN ILLUSTRATION

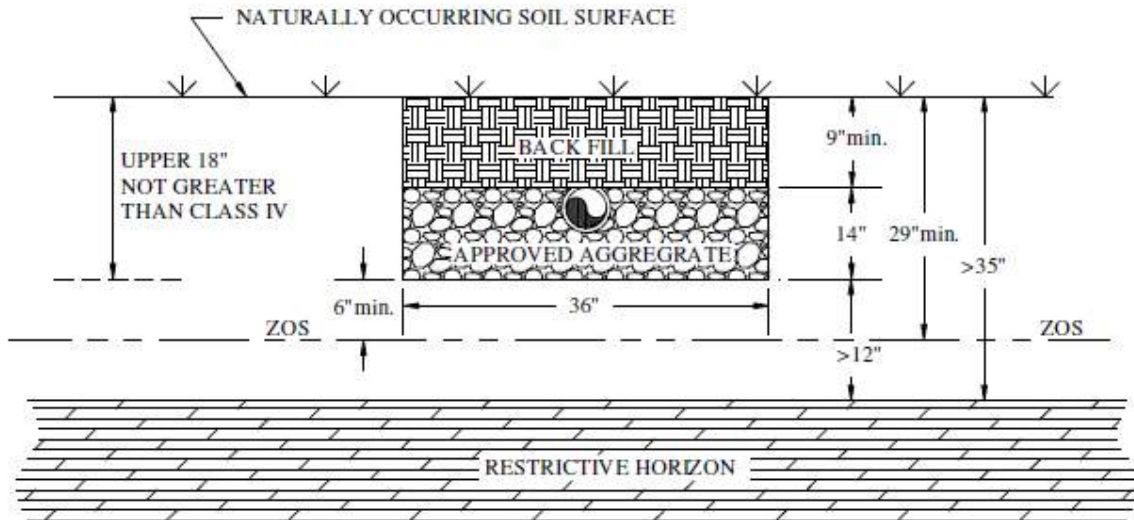

NOT TO SCALE

Rev. 03/09/18

~~401 Appendix A – SYSTEM STANDARD 150 – LARGE (greater than 1500 GPD) AND COMMUNITY~~  
~~ONSITE WASTEWATER SYSTEMS~~ **Appendix B - System Standard 150 - Large (greater than 1,500 gpd) and Community Systems**

~~401.1 SITE/PERMITTING REQUIREMENTS~~

(1) Site/Permitting Requirements

(a) The Department may require that designs for large and community onsite wastewater systems be prepared by a Registered Professional Engineer licensed in the State of South Carolina. Further, the Department may require whatever engineering and soils based submittals are deemed necessary to determine the feasibility and acceptability of any site for such a system.

(b) No part of the system, with the exception of solid pipe, may be located within one hundred (100) linear feet of a receptor.

(2)(c) The depth to the zone of saturation (ZOS) shall be at least thirty-six (36) inches below the naturally occurring soil surface, and at least six (6) inches below the deepest point of effluent application.

(3)(d) The depth to any restrictive horizon must be greater than twelve (12) inches below the bottom of the proposed wastewater infiltration trenches.

(4)(e) The ~~Long Term Acceptance Rate~~ long term acceptance rate for system sizing shall be based upon the most hydraulically limiting, naturally occurring soil texture from the ground surface to twelve (12) inches below the bottom of the proposed wastewater infiltration trenches.

(5)(f) There shall be at least fifty (50) percent reserved subsurface wastewater infiltration area repair or replacement area available consisting of soils suitable for a large onsite wastewater system, except where public (community) systems are utilized, in which case there must be at least one hundred (100) percent repair or replacement area.

(6)(g) Large (greater than 1500 gpd) and community onsite wastewater systems incorporating advanced treatment methods, including but not limited to aerobic pre-treatment, lagoons, surface or subsurface drip irrigation, low pressure pipe distribution, and other maintenance intensive methods, shall be required to obtain a Land Application Permit under ~~R. 61-9.505~~ R.61-9.505.

(7)(h) Efforts to circumvent the requirements of this standard by configuring remote, individually deeded, adjacently located subsurface wastewater infiltration areas in lieu of a community onsite wastewater system shall not be permitted. On a very limited basis, a few of these individual systems may be considered for mass installation where the wastewater infiltration trenches will be adjacent to each other in a defined area, provided that the combined peak wastewater loading is less than fifteen hundred (1500) gpd. In such cases:

(a)(i) Each subsurface wastewater infiltration area plot shall be sized such that there is sufficient area for one hundred (100) percent subsurface wastewater infiltration area replacement.

(b)(ii) Each plot shall be deeded with all appropriate easements as a lot in conjunction with the specific unit that it serves, and required protective offsets, as described in Section 200.6, shall apply to each individual remote subsurface wastewater infiltration area.

~~\_\_~~(e)(iii) A plan shall be prepared by a Registered Professional Engineer licensed in the State of South Carolina that illustrates the overall plan; specifies the route and identification of effluent sewers and ~~fore~~remains force mains; specifies the entity responsible for perpetual maintenance of the sewer lines and mass subsurface wastewater infiltration area; specifies the configuration and identification of the individual subsurface wastewater infiltration area parcels; and specifies the manner in which ingress and egress will be provided to the individual subsurface wastewater infiltration area parcels.

~~\_\_~~(d)(iv) When the combined peak wastewater loading of the adjacently located subsurface wastewater infiltration areas from the entire project will exceed fifteen hundred (1500) gpd, the project shall be considered as a public (community) collection and treatment system, and all requirements described in Section ~~402.5~~103.1(5) and this standard shall apply.

#### ~~\_\_~~401.2 INSTALLATION REQUIREMENTS(2) Installation Requirements

~~\_\_~~(1)(a) Large (greater than 1500 gpd) and community onsite wastewater systems shall not be constructed in fill material, and shall not be placed any closer to receptors than one hundred (100) feet.

~~\_\_~~(2)(b) Conventional wastewater infiltration trenches installed in the naturally occurring soil and having a width of thirty-six (36) inches shall be utilized.

~~\_\_~~(3)(c) Wherever possible, designs that favor long wastewater infiltration trenches, convex landscape positions, and rectangular subsurface wastewater infiltration area configurations shall be required.

~~\_\_~~(4)(d) All tree/brush removal shall be done in a manner that minimizes the disturbance or loss of naturally occurring soil.

#### ~~\_\_~~401.3 COMMUNITY OR CLUSTER COLLECTION AND TREATMENT ONSITE WASTEWATER SYSTEMS(3) Community or Cluster Collection and Treatment Onsite Wastewater Systems

~~\_\_~~(1)(a) An onsite wastewater system serving more than one (1) piece of deeded property shall be considered as a public (community) collection and treatment system.

~~\_\_~~(2)(b) A permit activity will not occur that is inconsistent with a plan or plan amendment approved under Section 208(b) of the Clean Water Act, unless the Department finds such variance necessary to protect the public's health, safety, and welfare.

~~\_\_~~(3)(c) A public entity shall own the system and shall be responsible for the operation, maintenance, and replacement of all components unless otherwise approved by the Department. The Department may consider a request from a private entity or person; however, such proposals must be evaluated on a case-by-case basis. The Department will evaluate the capability of long-term, reliable system operation in its evaluation of a permit request.

~~\_\_~~(4)(d) If the project is owned by a private entity or person, the Department shall require financial assurances for the operation, maintenance, and replacement of the tank(s) and subsurface wastewater infiltration area system and relevant collection/pumping components.

~~\_\_~~(5)(e) Sufficient area meeting the minimum requirements for large onsite wastewater systems shall be provided for at least one hundred (100) percent repair or replacement of the primary subsurface wastewater infiltration area.

~~\_\_ (6)(f)~~ The collection sewer and pumping portions of a community onsite wastewater system shall receive a separate Construction Permit under ~~R. 61-67.300~~ R.61-67.300.

~~\_\_ (7)(g)~~ The permit holder shall be required to properly operate and maintain in good working order, and operate as efficiently as possible, all facilities and systems which are installed or used to achieve compliance with the terms and conditions of the permit.

~~402 Appendix B - System Standard 210/211 - Shallow Placement With 9-Inch Aggregate Depth~~

## **Appendix C - System Standard 210/211 - Shallow Placement with 9-Inch Aggregate Depth**

### 402.1 SITE/PERMITTING REQUIREMENTS(1) Site/Permitting Requirements

~~\_\_ (1)(a)~~ There must not be a zone of saturation (ZOS) within twenty-four (24) inches of the naturally occurring soil surface.

~~\_\_ (2)(b)~~ The depth to any restrictive horizon must be greater than twelve (12) inches below the bottom of the proposed wastewater infiltration trenches.

~~\_\_ (3)(c)~~ The texture in the upper eighteen (18) inches of naturally occurring soil may either be Class I, Class II, Class III, or Class IV.

~~\_\_ (4)(d)~~ The ~~Long Term Acceptance Rate~~ long term acceptance rate for system sizing shall be based upon the most hydraulically limiting naturally occurring soil texture from the ground surface to twelve (12) inches below the bottom of the proposed wastewater infiltration trenches.

~~\_\_ (5)(e)~~ Due to the decreased sidewall absorption area and the increased potential for ground water mounding near the surface, the Equivalency Factors for these systems shall be calculated by conventional wastewater infiltration trenches and increased by an additional factor of 0.09 times.

~~\_\_ (6)(f)~~ There shall be a replacement area equivalent to at least fifty (50) percent in size of the original system area held in reserve for system repair. This area shall have a suitable configuration, and shall meet the minimum soil and site conditions of ~~R. 61-56~~ R.61-56.

~~\_\_ (7)(g)~~ This system must not be used on slightly sloping sites that require serial distribution unless it can be demonstrated that the entire wastewater infiltration trench installation (i.e., side wall to side wall and end to end) can meet the required textural limitations and the required offsets to the zone of saturation and restrictive horizons. ~~Level installations on slightly sloping sites can be considered if the above requirements can be met.~~

~~\_\_ (8)(h)~~ This system cannot be considered for facilities with peak flow rates in excess of fifteen hundred (1500) gallons per day gpd.

### 402.2 INSTALLATION REQUIREMENTS(2) Installation Requirements

~~(1) Serial distribution is restricted (see item 7. above).~~

~~\_\_ (2)(a)~~ The wastewater infiltration trench aggregate shall be nine (9) inches in depth and shall be covered with at least nine (9) inches of backfill.

~~\_\_ (3)(b)~~ The ~~maximum~~ wastewater infiltration trench width shall be thirty-six (36) inches; ~~the minimum width shall be eighteen (18) inches.~~

~~\_\_~~(4)(c) The maximum depth of the bottom of the wastewater infiltration trench shall be eighteen (18) inches below the naturally occurring soil surface unless it can be demonstrated that deeper placement can meet the required textural limitations and the offsets to the zone of saturation and restrictive horizons.

~~\_\_~~(5)(d) Where gravity flow from the septic tank to the subsurface wastewater infiltration area is utilized, the invert elevation of the septic tank outlet shall be installed at an elevation at least equal to or higher than the top of the aggregate in the highest wastewater infiltration trench(es).

~~\_\_~~(6)(e) All tree and brush removal shall be done in a manner that minimizes the disturbance or loss of naturally occurring soil.

~~\_\_~~ 402.3 ~~FINAL LANDSCAPING AND DRAINAGE~~(3) Final Landscaping and Drainage

~~\_\_~~(1)(a) Installation of drainage swales, ditches, curtain drains, and rain gutters may be required to divert or intercept water away from the onsite wastewater system location to a positive outfall. The septic tank and subsurface wastewater infiltration area shall be backfilled and shaped to promote surface water runoff.

~~\_\_~~(2)(b) A barrier to preclude parking and vehicular traffic over the system area may be required.

~~\_\_~~(3)(c) Following final landscaping, seeding or sodding may be required to prevent erosion.

~~\_\_~~(4)(d) Final approval shall be withheld until all landscaping and drainage improvements have been satisfactorily completed.

**SOUTH CAROLINA DEPARTMENT OF HEALTH AND ENVIRONMENTAL CONTROL  
BUREAU OF ENVIRONMENTAL HEALTH**

ALTERNATIVE SYSTEM  
SHALLOW PLACEMENT WITH NINE (9) INCH AGGREGATE DEPTH

PROGRAM 362 / CODE 210 / CODE 211 IF PUMPED

**TYPICAL DESIGN ILLUSTRATION**

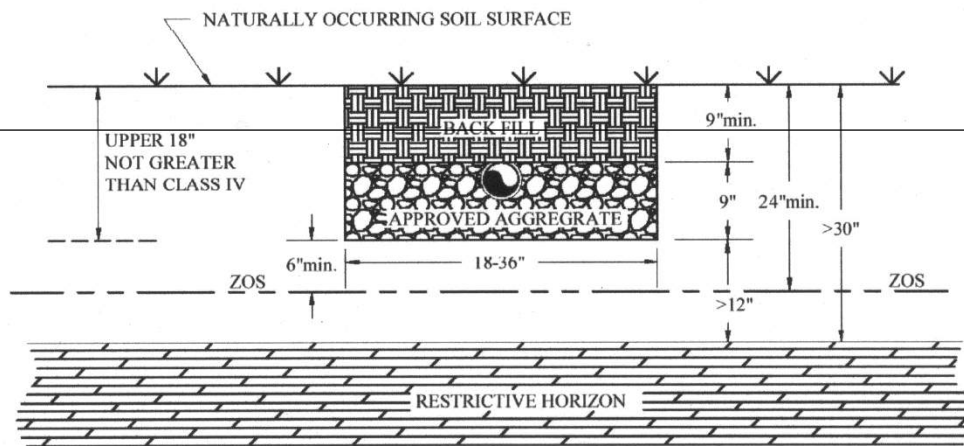

SCALE: 3/4"=1'

TLS REV 03/2007



SOUTH CAROLINA DEPARTMENT OF HEALTH AND ENVIRONMENTAL CONTROL  
BUREAU OF ENVIRONMENTAL HEALTH SERVICES

ALTERNATIVE STANDARD  
SHALLOW PLACEMENT WITH NINE (9) INCH AGGREGATE DEPTH

PROGRAM 362 / CODE 210 / CODE 211 IF PUMPED

TYPICAL DESIGN ILLUSTRATION

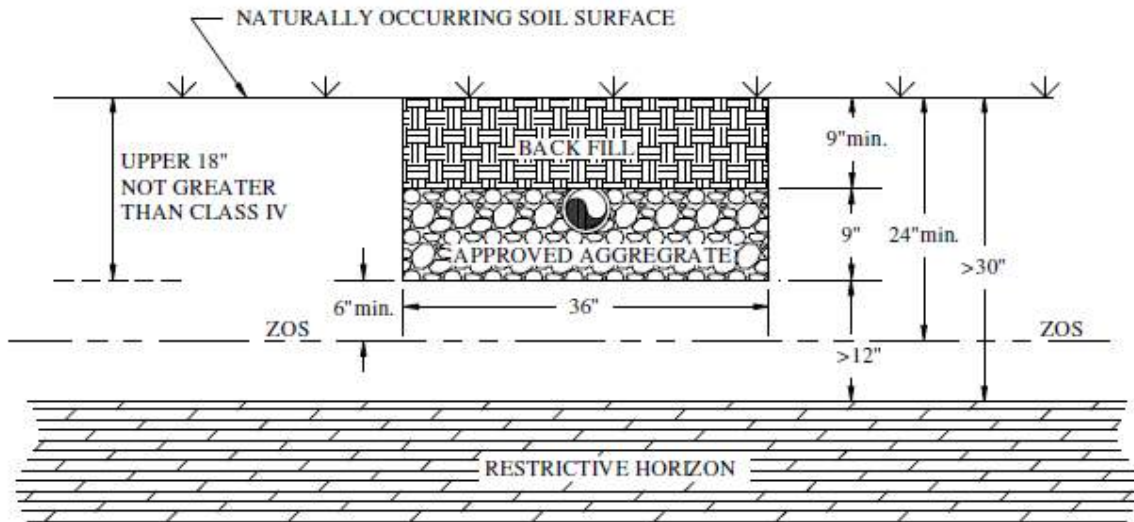

NOT TO SCALE

Rev. 03/09/18

~~403 Appendix C - SYSTEM STANDARD 220/221 - SHALLOW PLACEMENT WITH 6 INCH AGGREGATE DEPTH~~  
**Appendix D - System Standard 220/221 - Shallow Placement with Aggregate Depth**

~~403.1 SITE/PERMITTING REQUIREMENTS~~  
(1) Site/Permitting Requirements

~~(1)(a)~~ There must not be a zone of saturation (ZOS) within twenty-one (21) inches of the naturally occurring soil surface.

~~(2)(b)~~ The depth to any restrictive horizon must be greater than twelve (12) inches below the bottom of the proposed wastewater infiltration trenches.

~~(3)(c)~~ The texture in the upper eighteen (18) inches of naturally occurring soil may either be Class I, Class II, Class III, Class or IV.

~~(4)(d)~~ The ~~Long-Term Acceptance Rate~~ long term acceptance rate for system sizing shall be based upon the most hydraulically limiting naturally occurring soil texture from the ground surface to twelve (12) inches below the bottom of the proposed wastewater infiltration trenches.

~~(5)(e)~~ Due to the decreased sidewall absorption area and the increased potential for ground water mounding near the surface, the Equivalency Factors for these systems shall be calculated by conventional wastewater infiltration trenches and increased by an additional factor of 0.12 times.

~~(6)(f)~~ There shall be a replacement area equivalent to at least fifty (50) percent in size of the original system area held in reserve for system repair. This area shall have a suitable configuration, and shall meet the minimum soil and site conditions of ~~R.61-56~~ R.61-56.

~~(7)(g)~~ This system must not be used on slightly sloping sites that require serial distribution unless it can be demonstrated that the entire wastewater infiltration trench installation (i.e., side wall to side wall and end to end) can meet the required textural limitations and the required offsets to the zone of saturation and restrictive horizons. ~~Level installations on slightly sloping sites can be considered if the above limitations can be met.~~

~~(8)(h)~~ This system cannot be considered for facilities with peak flow rates in excess of fifteen hundred (1500) gallons per day gpd.

~~403.2 INSTALLATION REQUIREMENTS~~  
(2) Installation Requirements

~~(1) Serial distribution is restricted (see Section 403.1(7)).~~

~~(2)(a)~~ The wastewater infiltration trench aggregate shall be six (6) inches in depth and shall be covered with at least nine (9) inches of backfill.

~~(3)(b)~~ The ~~maximum~~ wastewater infiltration trench width shall be thirty-six (36) inches; ~~the minimum width shall be eighteen (18) inches.~~

~~(4)(c)~~ The maximum depth of the bottom of the wastewater infiltration trench shall be fifteen (15) inches below the naturally occurring soil surface unless it can be demonstrated that deeper placement can meet the required textural limitations and the offsets to the zone of saturation and restrictive horizons.

~~\_\_ (5)(d)~~ Where gravity flow from the septic tank to the subsurface wastewater infiltration area is utilized, the invert elevation of the septic tank outlet shall be installed at an elevation at least equal to or higher than the top of the aggregate in the highest wastewater infiltration trench(es).

~~\_\_ (6)(e)~~ All tree and brush removal shall be done in a manner that minimizes the disturbance or loss of naturally occurring soil.

~~\_\_ 403.3 FINAL LANDSCAPING AND DRAINAGE~~ (3) Final Landscaping and Drainage

~~\_\_ (1)(a)~~ Installation of drainage swales, ditches, curtain drains, and rain gutters may be required to divert or intercept water away from the onsite wastewater system location to a positive outfall. The septic tank and subsurface wastewater infiltration area shall be backfilled and shaped to promote surface water runoff.

~~\_\_ (2)(b)~~ A barrier to preclude parking and vehicular traffic over the system area may be required.

~~\_\_ (3)(c)~~ Following final landscaping, seeding or sodding may be required to prevent erosion.

~~\_\_ (4)(d)~~ Final approval shall be withheld until all landscaping and drainage improvements have been satisfactorily completed.

**SOUTH CAROLINA DEPARTMENT OF HEALTH AND ENVIRONMENTAL CONTROL  
BUREAU OF ENVIRONMENTAL HEALTH**

ALTERNATIVE SYSTEM  
SHALLOW PLACEMENT WITH SIX (6) INCH AGGREGATE DEPTH

PROGRAM 362 / CODE 220 / CODE 221 IF PUMPED

**TYPICAL DESIGN ILLUSTRATION**

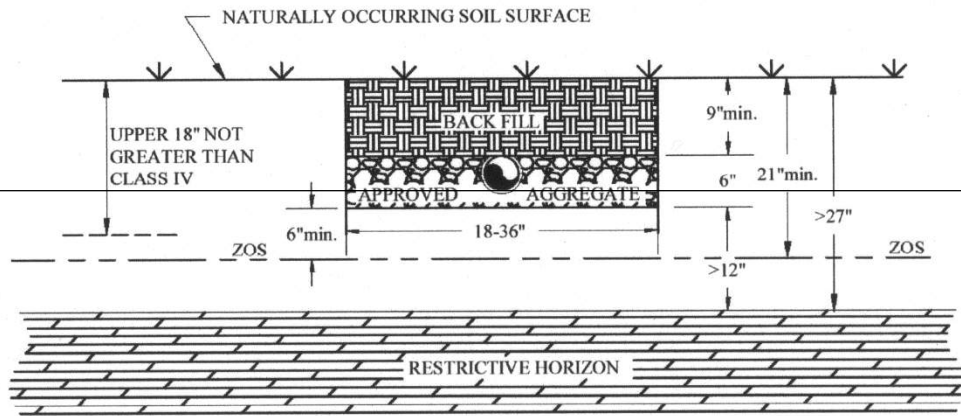

SCALE: 3/4"=1'

FLS REV. 03/16/07

**SOUTH CAROLINA DEPARTMENT OF HEALTH AND ENVIRONMENTAL CONTROL  
BUREAU OF ENVIRONMENTAL HEALTH SERVICES**

ALTERNATIVE STANDARD  
SHALLOW PLACEMENT WITH SIX (6) INCH AGGREGATE DEPTH

PROGRAM 362 / CODE 220 / CODE 221 IF PUMPED

**TYPICAL DESIGN ILLUSTRATION**

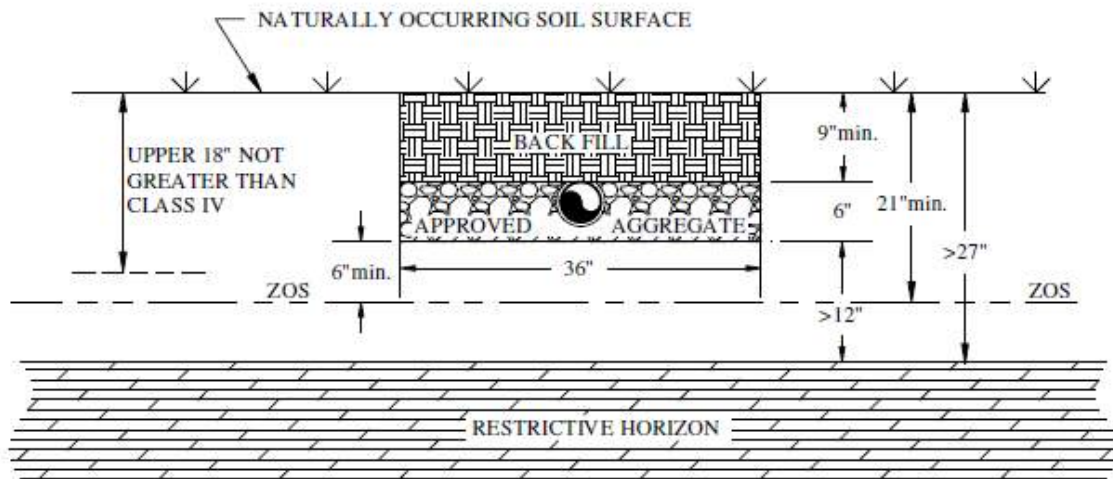

NOT TO SCALE

Rev. 03/09/18

404 APPENDIX D ~~System Standard 230/231~~ ~~Shallow Placement System WITH 14 INCH AGGREGATE DEPTH With Fill Cap~~ **Appendix E - System Standard 230/231 - Shallow Placement with 14-Inch Aggregate Depth with Fill Cap**

~~404.1 SITE/PERMITTING REQUIREMENTS~~ (1) Site/Permitting Requirements

~~(1)(a)~~ There must not be a zone of saturation (ZOS) within twenty (20) inches of the naturally occurring soil surface.

~~(2)(b)~~ The depth to any restrictive horizon must be greater than twelve (12) inches below the bottom of the proposed wastewater infiltration trenches.

~~(3)(c)~~ The texture in the upper eighteen (18) inches of naturally occurring soil must be no more limiting than Class III.

~~(4)(d)~~ ~~This system must not be utilized on sites that require serial distribution. Level installations on slightly sloping sites can be considered if it can be demonstrated that the entire installation (i.e., side wall to side wall and end to end) will meet the required textural limitations and the required offsets to the zone of saturation and restrictive horizons. This system must not be used on slightly sloping sites that require serial distribution unless it can be demonstrated that the entire wastewater infiltration trench installation (i.e., side wall to side wall and end to end) can meet the required textural limitations and the required offsets to the zone of saturation and restrictive horizons.~~

~~(5)(e)~~ ~~The Long Term Acceptance Rate~~ long term acceptance rate for system sizing shall be based upon the most hydraulically limiting naturally occurring soil texture from the ground surface to twelve (12) inches below the bottom of the proposed wastewater infiltration trenches.

~~(6)(f)~~ The total linear footage of wastewater infiltration trenches shall be the same as that required for conventional systems.

~~(7)(g)~~ There shall be a replacement area equivalent to at least fifty (50) percent in size of the original system area held in reserve for system repair. This area shall have a suitable configuration, and shall meet the minimum soil and site conditions of ~~R. 61-56~~ R.61-56.

~~(8)(h)~~ This system cannot be considered for facilities with peak flow rates in excess of fifteen hundred (1500) gallons per day gpd.

~~404.2 INSTALLATION REQUIREMENTS~~ (2) Installation Requirements

~~(1)(a)~~ The ~~maximum~~ wastewater infiltration trench width ~~must not exceed~~ shall be thirty-six (36) inches; the minimum width shall be eighteen (18) inches.

~~(2)(b)~~ The maximum depth of the bottom of the wastewater infiltration trench shall be fourteen (14) inches below the naturally occurring soil surface unless it can be demonstrated that deeper placement can meet the required textural limitations and the offsets to the zone of saturation and restrictive horizons.

~~(3)(c)~~ The depth of the fill cap shall provide a minimum of twelve (12) inches ~~backfill of soil cover~~ above the top of the wastewater infiltration trench aggregate. (see attached illustration)

~~\_\_~~(4)(d) Where gravity flow from the septic tank to the subsurface wastewater infiltration area is utilized, the invert elevation of the septic tank outlet shall be installed at an elevation at least equal to or higher than the top of the aggregate in the highest wastewater infiltration trench(es).

~~\_\_~~(5)(e) The required fill cap must extend at least five (5) feet beyond the limits of the subsurface wastewater infiltration trenches, and must taper to the original soil surface at a slope not to exceed 10 percent. ~~(see attached illustration)~~. On sloping sites, where serial distribution has been incorporated into the system design, on the lower side and ends of the wastewater infiltration trenches, the fill cap must extend to at least ten (10) feet beyond the limits of the wastewater infiltration trenches and must taper to the original soil surface at a slope not to exceed five (5) percent. The required property line setback shall be measured from the point at which the fill cap taper intersects with the natural soil surface. The fill cap must be installed prior to beginning trench installation when required on the construction permit.

~~\_\_~~(6)(f) The required fill material must be soil texture Class I, Class II or Class III and be devoid of extraneous debris such as organic matter, building materials, etc.

~~\_\_~~(7)(g) The wastewater infiltration trench aggregate shall be fourteen (14) inches in depth.

~~\_\_~~(8)(h) All tree/brush removal shall be done in a manner that minimizes the disturbance or loss of naturally occurring soil.

~~\_\_~~ 404.3 ~~FINAL LANDSCAPING AND DRAINAGE~~ (3) Final Landscaping and Drainage

~~\_\_~~(1)(a) The septic tank and fill cap area shall be backfilled and shaped to promote the runoff of surface water.

~~\_\_~~(2)(b) Where natural surface drainage does not exist, a swale shall be constructed adjacent to the fill cap area to divert surface water away from the onsite wastewater system to a positive outfall. The installation of ditches, curtain drains, and rain gutters may be required to intercept and divert water away from the onsite wastewater system location.

~~\_\_~~(3)(c) A barrier to preclude parking and vehicular traffic over the system area may be required.

~~\_\_~~(4)(d) Following final landscaping, seeding or sodding may be required to prevent erosion.

~~\_\_~~(5)(e) Final approval shall be withheld until all landscaping and drainage improvements have been satisfactorily completed.

**SOUTH CAROLINA DEPARTMENT OF HEALTH AND ENVIRONMENTAL CONTROL  
BUREAU OF ENVIRONMENTAL HEALTH**

ALTERNATIVE SYSTEM  
SHALLOW PLACEMENT SYSTEM WITH FILL CAP  
PROGRAM 362 / CODE 230 / CODE 231 IF PUMPED

**TYPICAL DESIGN ILLUSTRATION**

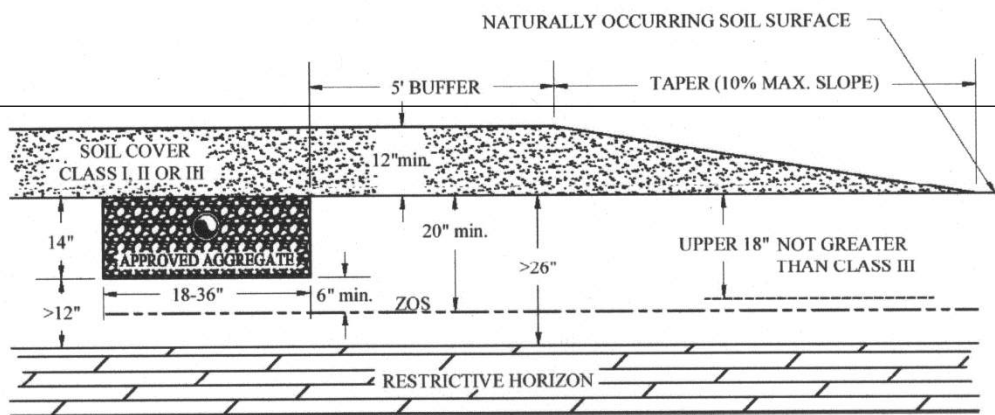

NOT TO SCALE

T15 REV. 03/16/07



SOUTH CAROLINA DEPARTMENT OF HEALTH AND ENVIRONMENTAL CONTROL  
BUREAU OF ENVIRONMENTAL HEALTH SERVICES

ALTERNATIVE STANDARD  
SHALLOW PLACEMENT SYSTEM WITH FILL CAP  
PROGRAM 362 / CODE 230 / CODE 231 IF PUMPED

TYPICAL DESIGN ILLUSTRATION

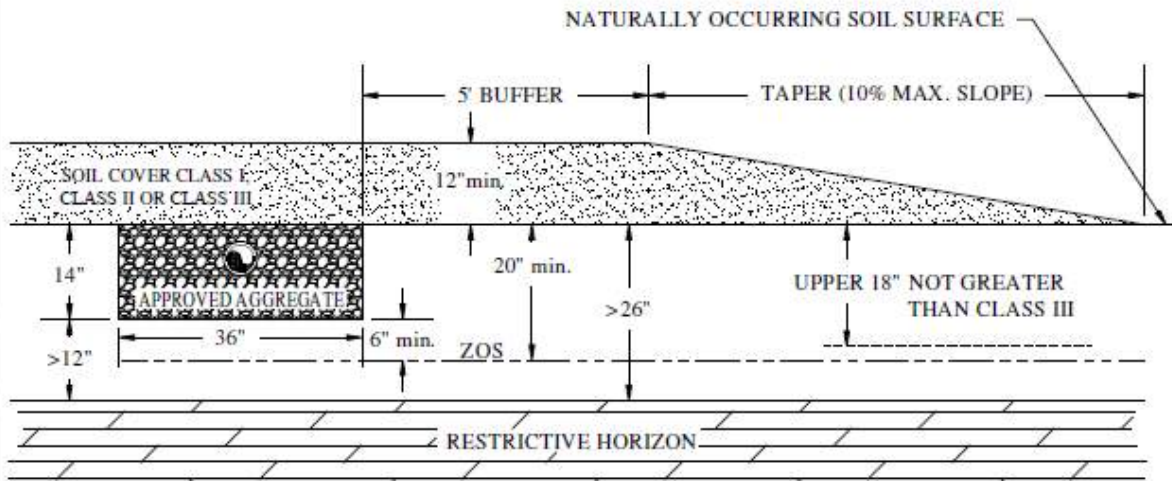

NOT TO SCALE

Rev. 03/09/18

~~405 Appendix E - SYSTEM STANDARD 240/241 - ULTRA SHALLOW PLACEMENT WITH 6-INCH AGGREGATE DEPTH WITH FILL CAP~~ **Appendix F - System Standard 240/241 - Ultra Shallow Placement with 6-Inch Aggregate Depth with Fill Cap**

~~405.1 SITE/PERMITTING REQUIREMENTS~~ (1) Site/Permitting Requirements

~~(1)(a)~~ There must not be a zone of saturation (ZOS) within twelve (12) inches of the naturally occurring soil surface.

~~(2)(b)~~ The depth to any restrictive horizon must be greater than twelve (12) inches below the bottom of the proposed wastewater infiltration trenches.

~~(3)(c)~~ The soil texture in the upper eighteen (18) inches of naturally occurring soil must be no more limiting than Class III.

~~(4)(d)~~ This system must not be utilized on sites that require serial distribution. Level installations on slightly sloping sites can be considered if it can be demonstrated that the entire installation (i.e., side wall to side wall and end to end) will meet the required textural limitations and the required offsets to the zone of saturation and restrictive horizons. This system must not be used on slightly sloping sites that require serial distribution unless it can be demonstrated that the entire wastewater infiltration trench installation (i.e., side wall to side wall and end to end) meets the required textural limitations and required offsets to the zone of saturation and restrictive horizons.

~~(5)(e)~~ No part of this system can be installed within one hundred twenty-five (125) feet of the critical area line or tidal waters as determined by the Department; or within one hundred twenty-five (125) feet of the ordinary high water elevation within the banks of non-tidal, environmentally sensitive waters.

~~(6)(f)~~ ~~The Long Term Acceptance Rate~~ long term acceptance rate for system sizing shall be based upon the most hydraulically limiting naturally occurring soil texture from the ground surface to twelve (12) inches below the bottom of the proposed wastewater infiltration trenches.

~~(7)(g)~~ Due to the decreased sidewall area and the increased potential for ground water mounding near the surface, the Equivalency Factors for these systems shall be calculated by conventional wastewater infiltration trenches and increased by an additional factor of 0.12 times.

~~(8)(h)~~ There shall be a replacement area equivalent to at least fifty (50) percent in size of the original system area held in reserve for system repair. This area shall have a suitable configuration, and shall meet the minimum soil and site conditions of ~~R. 61-56~~ R.61-56.

~~(9)(i)~~ This system cannot be considered for facilities with peak flow rates in excess of fifteen hundred (1500) ~~gallons per day~~ gpd.

~~405.2 INSTALLATION REQUIREMENTS~~ (2) Installation Requirements

~~(1)(a)~~ ~~The maximum wastewater infiltration trench width must not exceed~~ shall be ~~thirty-six (36) inches; the minimum width shall be 18 inches.~~ thirty-six (36) inches.

~~(2)(b)~~ The maximum depth of the bottom of the wastewater infiltration trench shall be six (6) inches below the naturally occurring soil surface unless it can be demonstrated that deeper placement can meet the required textural limitations and offsets to the zone of saturation and restrictive horizons.

~~\_\_~~(3)(c) The depth of the fill cap shall provide a minimum of twelve (12) inches backfill above the top of the wastewater infiltration trench aggregate ~~(see attached illustration)~~.

~~\_\_~~(4)(d) Where gravity flow from the septic tank to the subsurface wastewater infiltration area is utilized, the invert elevation of the septic tank outlet shall be installed at an elevation at least equal to or higher than the top of the aggregate in the highest wastewater infiltration trench(es).

~~\_\_~~(5)(e) The required fill cap must extend at least five (5) feet beyond the limits of the subsurface wastewater infiltration trenches, and must taper to the original soil surface at a slope not to exceed of 10 percent. ~~(see attached illustration)~~ On sloping sites where serial distribution has been incorporated into the system design, on the lower side and ends of the wastewater infiltration trenches, the fill cap must extend to at least ten (10) feet beyond the limits of the wastewater infiltration trenches and must taper to the original soil surface at a slope not to exceed five (5) percent. The required property line setback shall be measured from the point at which the fill cap taper intersects with the natural soil surface. The fill cap must be installed prior to beginning trench installation when required on the construction permit.

~~\_\_~~(6)(f) The required fill material must be soil texture Class I, Class II, or Class III, and be devoid of extraneous debris such as organic matter, building materials, etc.

~~\_\_~~(7)(g) The wastewater infiltration trench aggregate shall be six (6) inches in depth.

~~\_\_~~(8)(h) All tree/brush removal shall be done in a manner that minimizes the disturbance or loss of naturally occurring soil.

#### ~~\_\_~~405.3 FINAL LANDSCAPING AND DRAINAGE~~(3) Final Landscaping and Drainage~~

~~\_\_~~(1)(a) The septic tank and fill cap area shall be backfilled and shaped to promote the runoff of surface water.

~~\_\_~~(2)(b) Where natural surface drainage does not exist, a swale shall be constructed adjacent to the fill cap area to divert surface water away from the onsite wastewater system to a positive outfall. The installation of ditches, curtain drains, and rain gutters may be required to intercept and divert water away from the onsite wastewater system location.

~~\_\_~~(3)(c) A barrier to preclude parking and vehicular traffic over the system area may be required.

~~\_\_~~(4)(d) Following final landscaping, seeding or sodding may be required to prevent erosion.

~~\_\_~~(5)(e) Final approval shall be withheld until all landscaping and drainage improvements have been satisfactorily completed.

**SOUTH CAROLINA DEPARTMENT OF HEALTH AND ENVIRONMENTAL CONTROL  
BUREAU OF ENVIRONMENTAL HEALTH**

ALTERNATIVE SYSTEM  
ULTRA-SHALLOW PLACEMENT SYSTEM WITH FILL CAP

PROGRAM 362 / CODE 240 / CODE 241 IF PUMPED

**TYPICAL DESIGN ILLUSTRATION**

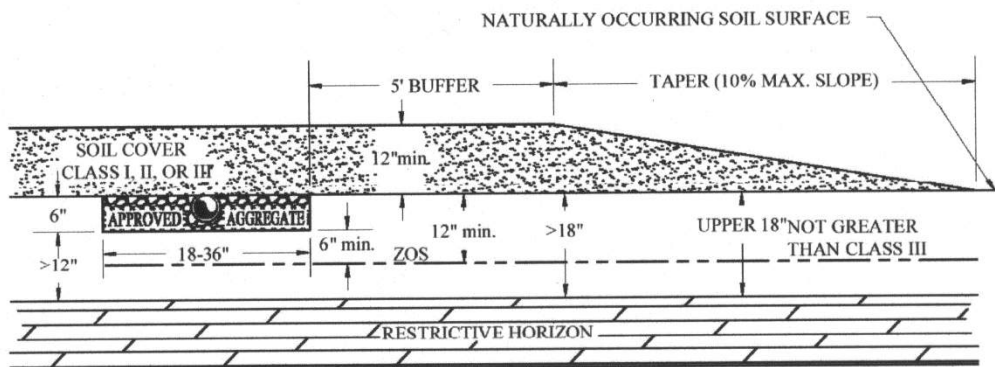

NOT TO SCALE

TLS REV 03/16/07

SOUTH CAROLINA DEPARTMENT OF HEALTH AND ENVIRONMENTAL CONTROL  
BUREAU OF ENVIRONMENTAL HEALTH SERVICES

ALTERNATIVE STANDARD  
ULTRA-SHALLOW PLACEMENT SYSTEM WITH FILL CAP

PROGRAM 362 / CODE 240 / CODE 241 IF PUMPED

TYPICAL DESIGN ILLUSTRATION

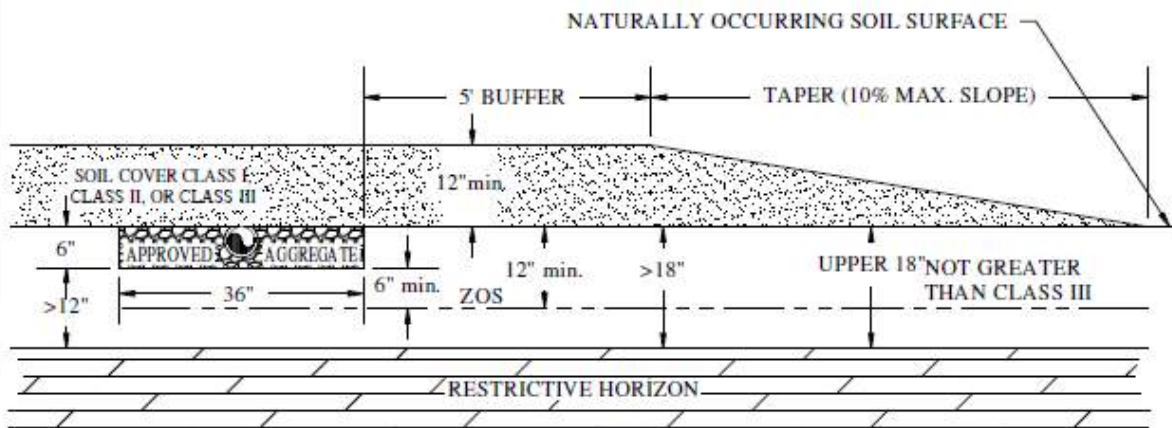

NOT TO SCALE

Rev. 03/09/18

406 APPENDIX F System Standard 250/251 Reservoir Infiltration System For Soils With Expansive Clay  
**Appendix G - System Standard 250/251 - Reservoir Infiltration System for Soils with Clay**

~~406.1~~ SITE/PERMITTING REQUIREMENTS (1) Site/Permitting Requirements

- ~~(1)(a)~~ Rock formations must be greater than four (4) feet below the naturally occurring soil surface.
- ~~(2)(b)~~ For standard installations (see Typical Design Illustration A), the wastewater infiltration trenches must penetrate the saprolite at least six (6) inches. ~~Also, there~~ There must be an offset greater than twelve (12) inches between the bottom of the trenches and any rock formations. (i.e., there must be greater than eighteen (18) inches of clean, unconsolidated saprolite below the expansive clay layer.)
- ~~(3)(c)~~ If the unconsolidated saprolite layer is greater than sixty (60) inches below the naturally occurring soil surface (see Typical Design Illustration B), ~~item 2-paragraph (1)(b)~~ (above) shall apply and clean medium sand shall be added to the trenches so that the top of the aggregate will be twelve (12) inches below finished grade.
- ~~(4)(d)~~ There must be no evidence of a zone of saturation (ZOS) in the unconsolidated saprolite layer.
- ~~(5)(e)~~ ~~The Long Term Acceptance Rate~~ long term acceptance rate shall not exceed 0.25 gpd/sq. ft.
- ~~(6)(f)~~ There shall be a replacement area equivalent to at least fifty (50) percent in size of the original system area held in reserve for system repair. This area shall have a suitable configuration, and shall meet the minimum soil and site conditions of ~~R. 61-56~~ R.61-56.
- ~~(7)(g)~~ Sites to be considered for this system shall be evaluated using backhoe pits to describe the soil profile.
- ~~(8)(h)~~ This system cannot be considered for facilities with peak flow rates in excess of fifteen hundred (1500) ~~gallons per day~~ gpd.

~~(a)(i)~~ Clean, unconsolidated saprolite shall be defined as: ~~Soft~~ soft, friable, thoroughly decomposed rock that has formed in place by chemical weathering, retaining the fabric and structure of the parent rock, and being devoid of expansive clay. Unconsolidated saprolite can be dug using a hand auger or knife. Consolidated saprolite cannot be penetrated with a hand auger or similar tool, and must be dug with a backhoe or other powered equipment.

~~(b)(ii)~~ Expansive clay shall be defined as soils containing significant amounts of expansible-layer clay minerals or smectites as evidenced in the field by classifications of Very Sticky and Very Plastic and Structure Grades of Weak or Structureless when evaluated in accordance with the Field Book. Such soils are considered to be unsuitable for onsite wastewater systems.

~~406.2~~ INSTALLATION REQUIREMENTS (2) Installation Requirements

- ~~(1)(a)~~ The ~~aggregate~~ depth of approved aggregate shall be twenty-four (24) inches.
- ~~(2)(b)~~ The depth of medium sand will vary between zero (0) and one hundred twenty (120) inches, depending upon the depth to the saprolite layer.
- ~~(3)(c)~~ The trench width shall be thirty-six (36) inches.

~~\_\_~~(4)(d) Where gravity flow from the septic tank to the subsurface wastewater infiltration area is utilized, the invert elevation of the septic tank outlet shall be installed at an elevation at least equal to or higher than the top of the aggregate in the highest wastewater infiltration trench(es).

~~\_\_~~(5)(e) The backfill shall range from twelve (12) inches to thirty-six (36) inches for standard installations (see Typical Design Illustration A), and shall be twelve (12) inches where the depth to saprolite is greater than sixty (60) inches below the naturally occurring soil surface (see Typical Design Illustration B).

~~\_\_~~406.3 FINAL LANDSCAPING AND DRAINAGE(3) Final Landscaping and Drainage

~~\_\_~~(1)(a) On sites where there is evidence of a zone of saturation at the soil-expansive clay interface, a curtain drain must be placed upslope along a contour and must extend the entire length of the subsurface wastewater infiltration area. The curtain drain shall extend a minimum of six (6) inches into the expansive clay layer. The septic tank and subsurface wastewater infiltration area shall be backfilled and shaped to promote surface water runoff.

~~\_\_~~(2)(b) Following final landscaping, seeding or sodding may be required to prevent erosion.

~~\_\_~~(3)(c) Final approval shall be withheld until all landscaping and drainage improvements have been satisfactorily completed.

**SOUTH CAROLINA DEPARTMENT OF HEALTH AND ENVIRONMENTAL CONTROL  
BUREAU OF ENVIRONMENTAL HEALTH**

**ALTERNATIVE SYSTEM  
RESERVOIR INFILTRATION SYSTEM FOR SOILS WITH EXPANSIVE CLAY**

PROGRAM 362 / CODE 250 / CODE 251 IF PUMPED

**TYPICAL DESIGN ILLUSTRATION (A)  
STANDARD INSTALLATION**

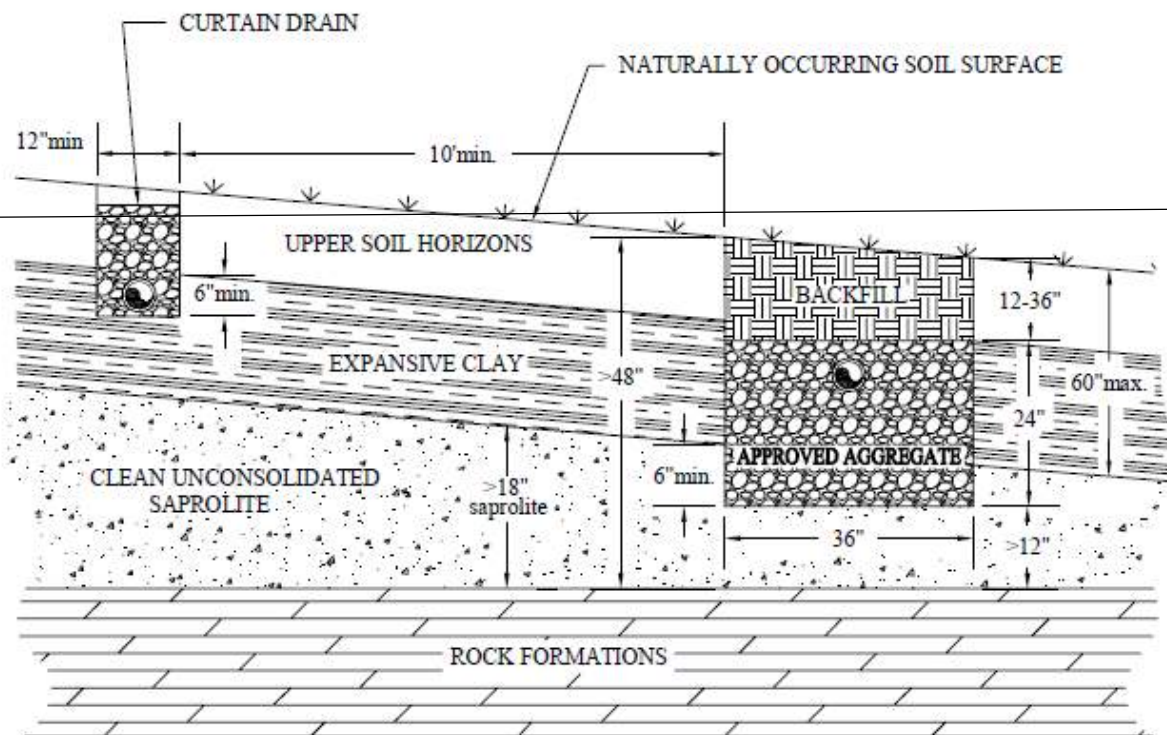

**NOTE: FOR SOILS WITH THICK EXPANSIVE CLAY HORIZONS  
(i.e., DEPTH TO SAPROLITE > 60 INCHES BELOW NATURALLY OCCURRING SOIL SURFACE)  
SEE TYPICAL DESIGN ILLUSTRATION (B)**

NOT TO SCALE

TS & DEW 05/16/07



**SOUTH CAROLINA DEPARTMENT OF HEALTH AND ENVIRONMENTAL CONTROL  
BUREAU OF ENVIRONMENTAL HEALTH**

ALTERNATIVE SYSTEM  
RESERVOIR INFILTRATION SYSTEM FOR SOILS WITH EXPANSIVE CLAY

PROGRAM 362 / CODE 250 / CODE 251 IF PUMPED

**TYPICAL DESIGN ILLUSTRATION (B)  
WHERE DEPTH TO SAPROLITE > 60in. BELOW SURFACE**

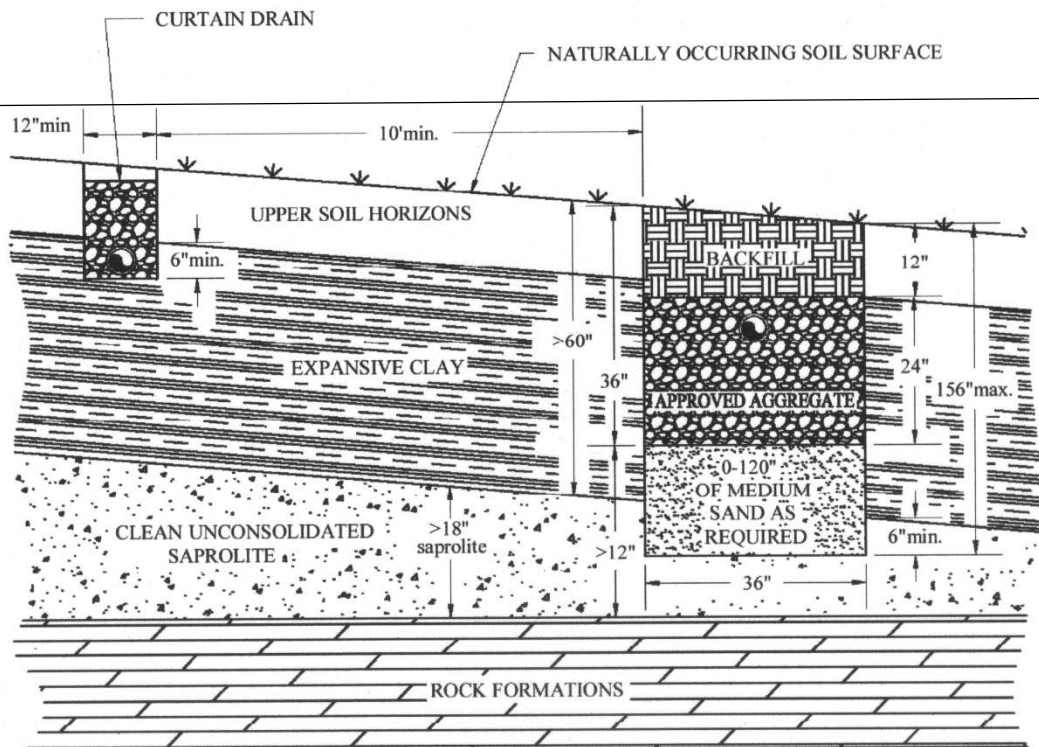

NOTE: FOR SOILS WITH THINNER EXPANSIVE CLAY HORIZONS  
(i.e., DEPTH TO SAPROLITE NOT >60in. BELOW NATURALLY OCCURRING SOIL SURFACE)  
SEE TYPICAL DESIGN ILLUSTRATION (A)

NOT TO SCALE

TLS REV. 03/16/97

SOUTH CAROLINA DEPARTMENT OF HEALTH AND ENVIRONMENTAL CONTROL  
BUREAU OF ENVIRONMENTAL HEALTH SERVICES

ALTERNATIVE SYSTEM  
RESERVOIR INFILTRATION SYSTEM FOR SOILS WITH EXPANSIVE CLAY

PROGRAM 362 / CODE 250 / CODE 251 IF PUMPED

TYPICAL DESIGN ILLUSTRATION (A)  
STANDARD INSTALLATION

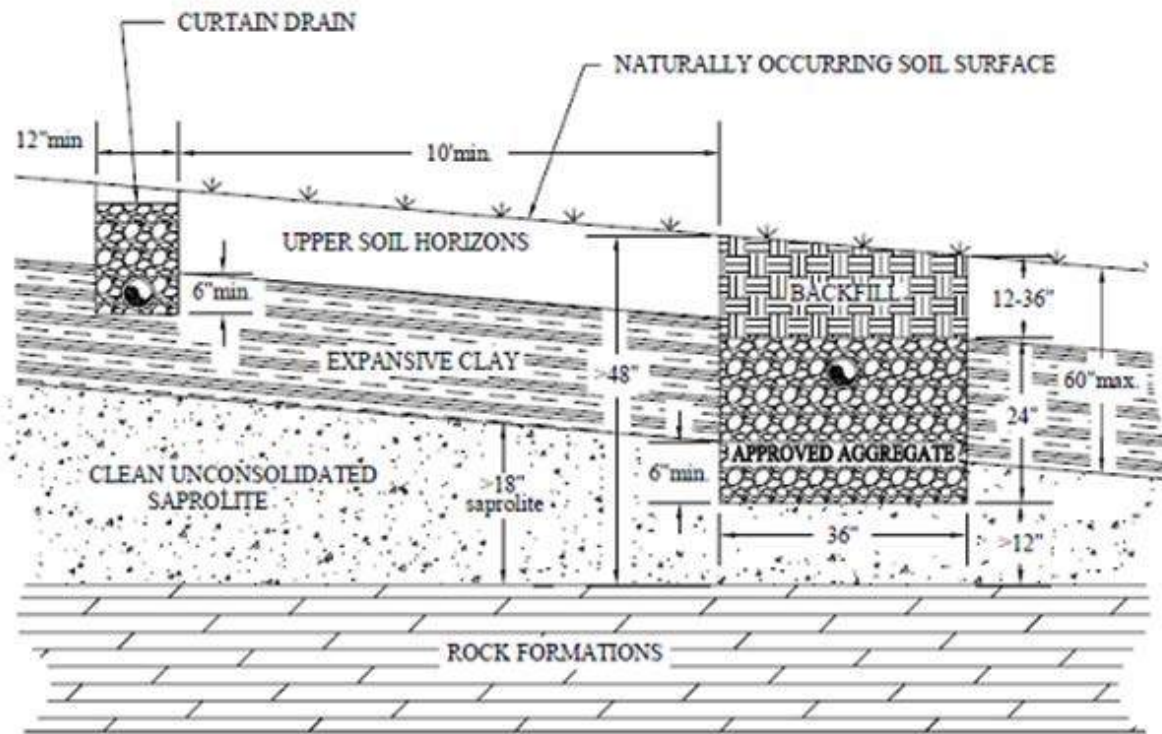

NOTE: FOR SOILS WITH THICK EXPANSIVE CLAY HORIZONS  
(i.e., DEPTH TO SAPROLITE > 60 INCHES BELOW NATURALLY OCCURRING SOIL SURFACE)  
SEE TYPICAL DESIGN ILLUSTRATION (B)

NOT TO SCALE  
Rev. 03/09/18

SOUTH CAROLINA DEPARTMENT OF HEALTH AND ENVIRONMENTAL CONTROL  
BUREAU OF ENVIRONMENTAL HEALTH SERVICES

ALTERNATIVE SYSTEM  
RESERVOIR INFILTRATION SYSTEM FOR SOILS WITH EXPANSIVE CLAY

PROGRAM 362 / CODE 250 / CODE 251 IF PUMPED

TYPICAL DESIGN ILLUSTRATION (B)  
WHERE DEPTH TO SAPROLITE > 60in. BELOW SURFACE

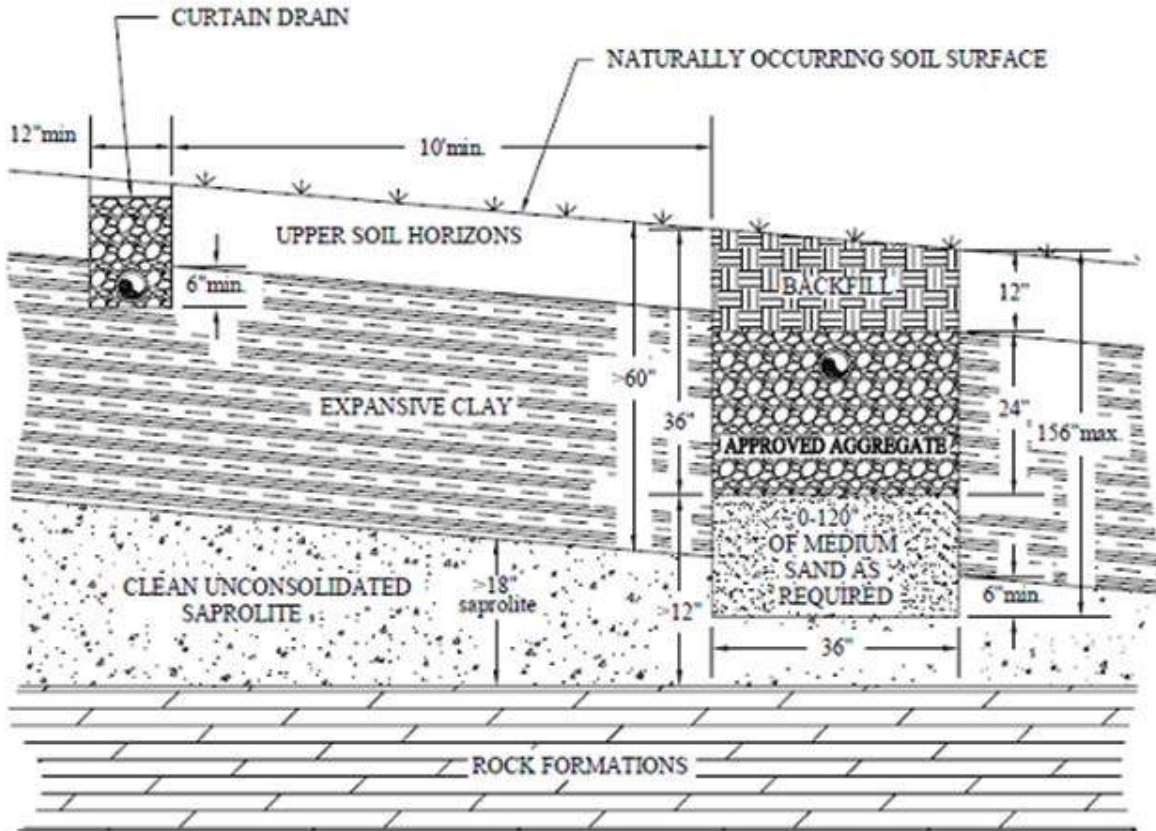

NOTE: FOR SOILS WITH THINNER EXPANSIVE CLAY HORIZONS  
(i.e., DEPTH TO SAPROLITE NOT >60in. BELOW NATURALLY OCCURRING SOIL SURFACE)  
SEE TYPICAL DESIGN ILLUSTRATION (A)

NOT TO SCALE  
Rev. 03/09/18

Cap **Appendix H - System Standard 260/261 - 9-Inch Shallow Placement System with Fill**

~~407.1 SITE/PERMITTING REQUIREMENTS~~(1) Site/Permitting Requirements

~~(1)(a)~~ There must not be a zone of saturation (ZOS) within fifteen (15) inches of the naturally occurring soil surface.

~~(2)(b)~~ The depth to any restrictive horizon must be greater than twelve (12) inches below the bottom of the proposed wastewater infiltration trenches.

~~(3)(c)~~ The texture in the upper eighteen (18) inches of naturally occurring soil must be no more limiting than Class III.

~~(4)(d)~~ ~~This system must not be utilized on sites that require serial distribution. Level installations on slightly sloping sites can be considered if it can be demonstrated that the entire installation (i.e., side wall to side wall and end to end) will meet the required textural limitations and the required offsets to the zone of saturation and restrictive horizons. This system must not be used on slightly sloping sites that require serial distribution unless it can be demonstrated that the entire wastewater infiltration trench installation (i.e., side wall to side wall and end to end) can meet the required textural limitations and the required offsets to the zone of saturation and restrictive horizons.~~

~~(5)(e)~~ The ~~Long Term Acceptance Rate~~ long term acceptance rate for system sizing shall be based upon the most hydraulically limiting naturally occurring soil texture from the ground surface to twelve (12) inches below the bottom of the proposed wastewater infiltration trenches.

~~(6)(f)~~ Due to the decreased sidewall absorption area and the increased potential for ground water mounding near the surface, the Equivalency Factors for these systems shall be calculated by conventional wastewater infiltration trenches and increased by an additional factor of 0.09 times.

~~(7)(g)~~ No part of this system can be installed within 125 feet of the critical area line or tidal waters as determined by the Department; or within 125 feet of the ordinary high water elevation within the banks of non-tidal, environmentally sensitive waters.

~~(8)(h)~~ There shall be a replacement area equivalent to at least fifty (50) percent in size of the original system area held in reserve for system repair. This area shall have a suitable configuration, and shall meet the minimum soil and site conditions of ~~R-61-56~~ R.61-56.

~~(9)(i)~~ This system cannot be considered for facilities with peak flow rates in excess of fifteen hundred (1500) ~~gallons per day~~ gpd.

~~407.2 INSTALLATION REQUIREMENTS~~(2) Installation Requirements

~~(1)(a)~~ The ~~maximum~~ wastewater infiltration trench width ~~must not exceed~~ shall be thirty-six (36) inches; ~~the minimum width shall be eighteen (18) inches.~~

~~(2)(b)~~ The maximum depth of the bottom of the wastewater infiltration trench shall be nine (9) inches below the naturally occurring soil surface unless it can be demonstrated that deeper placement can meet the required textural limitations and the offsets to the zone of saturation and restrictive horizons.

~~\_\_~~(3)(c) Where gravity flow from the septic tank to the subsurface wastewater infiltration area is utilized, the invert elevation of the septic tank outlet shall be installed at an elevation at least equal to or higher than the top of the aggregate in the highest wastewater infiltration trench(es).

~~\_\_~~(4)(d) The depth of the fill cap shall provide a minimum of twelve (12) inches backfill above the top of the wastewater infiltration trench aggregate ~~(see attached illustration)~~.

~~\_\_~~(5)(e) The required fill cap must extend at least five (5) feet beyond the limits of the wastewater infiltration trenches, and must taper to the original soil surface at a slope not to exceed 10 percent (see attached illustration). On sloping sites where serial distribution has been incorporated into the system design, on the lower side and ends of the wastewater infiltration trenches, the fill cap must extend to at least ten (10) feet beyond the limits of the wastewater infiltration trenches and must taper to the original soil surface at a slope not to exceed five (5) percent. The required property line setback shall be measured from the point at which the fill cap taper intersects with the naturally occurring soil surface. The fill cap must be installed prior to beginning trench installation when required on the construction permit.

~~\_\_~~(6)(f) The required fill material must be soil texture Class I, Class II, or Class III, and be devoid of extraneous debris such as organic matter, building materials, etc.

~~\_\_~~(7)(g) The wastewater infiltration trench aggregate shall be nine (9) inches in depth.

~~\_\_~~(8)(h) All trees/brush removal shall be done in a manner that minimizes the disturbance or loss of naturally occurring soil.

#### ~~\_\_~~407.3 ~~FINAL LANDSCAPING AND DRAINAGE~~(3) Final Landscaping and Drainage

~~\_\_~~(1)(a) The septic tank and fill cap area shall be backfilled and shaped to promote the runoff of surface water.

~~\_\_~~(2)(b) Where natural surface drainage does not exist, a swale shall be constructed adjacent to the fill cap area to divert surface water away from the onsite wastewater system to a positive outfall. The installation of ditches, curtain drains, and rain gutters may be required to intercept and divert water away from the onsite wastewater system location.

~~\_\_~~(3)(c) A barrier to preclude parking and vehicular traffic over the system area may be required.

~~\_\_~~(4)(d) Following final landscaping, seeding or sodding may be required to prevent erosion.

~~\_\_~~(5)(e) Final approval shall be withheld until all landscaping and drainage improvements have been satisfactorily completed.

**SOUTH CAROLINA DEPARTMENT OF HEALTH AND ENVIRONMENTAL CONTROL  
BUREAU OF ENVIRONMENTAL HEALTH**

ALTERNATIVE SYSTEM  
NINE INCH SHALLOW PLACEMENT WITH FILL CAP  
PROGRAM 362 / CODE 260 / CODE 261 IF PUMPED

**TYPICAL DESIGN ILLUSTRATION**

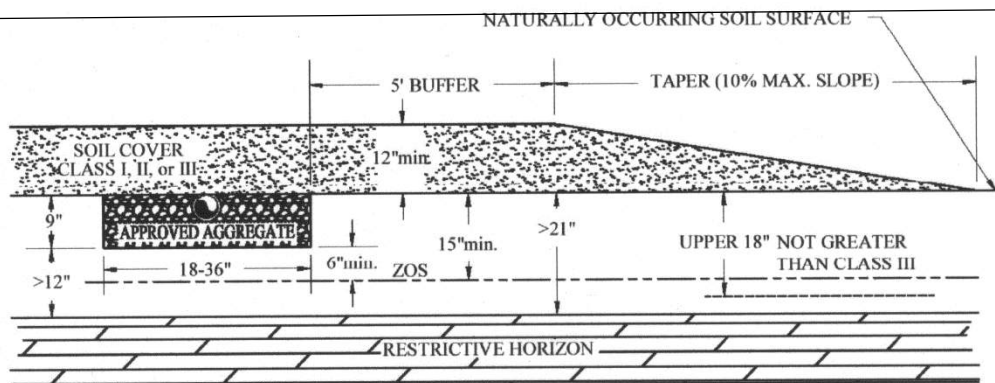

NOT TO SCALE

TDS REV. 03/13/97



SOUTH CAROLINA DEPARTMENT OF HEALTH AND ENVIRONMENTAL CONTROL  
BUREAU OF ENVIRONMENTAL HEALTH SERVICES

ALTERNATIVE STANDARD  
NINE INCH SHALLOW PLACEMENT WITH FILL CAP

PROGRAM 362 / CODE 260 / CODE 261 IF PUMPED

TYPICAL DESIGN ILLUSTRATION

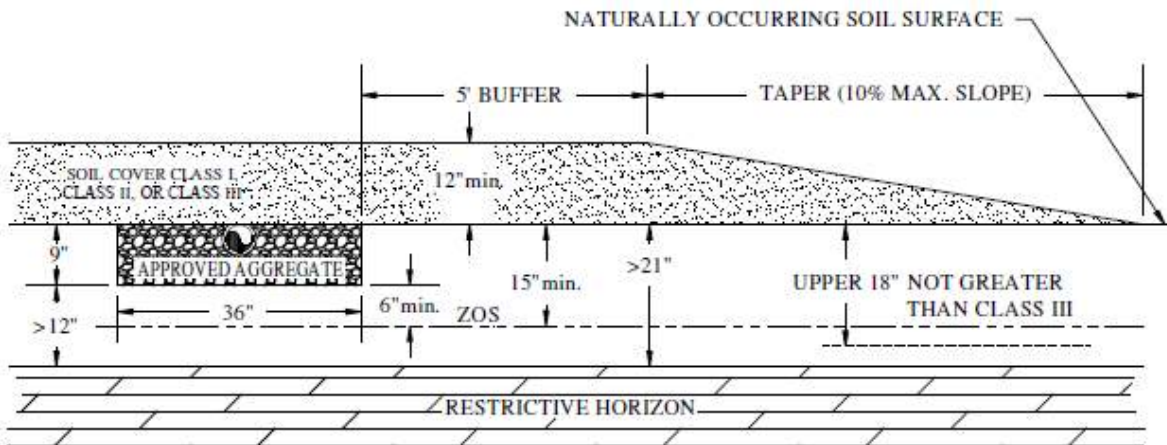

NOT TO SCALE

Rev. 03/09/18

408 APPENDIX H SYSTEM STANDARD 270/271 ALTERNATIVE TRENCH WIDTH AND DEPTH SYSTEMS **Appendix I - System Standard 270/271 - Alternative Trench Width and Depth Systems**

~~408.1 SITE/PERMITTING REQUIREMENTS~~(1) Site/Permitting Requirements

~~(1) Lot size or suitable area must be too small to accommodate a conventional or alternative onsite wastewater system.~~

~~(2) This Standard and associated systems shall not be used to calculate minimum lot sizes in new subdivisions approved after the effective date of this standard.~~

~~(3)(a) Soil conditions, the depth to rock and other restrictive horizons, the depth to the zone of saturation (ZOS), and the elevation differential between the septic tank outlet and the highest wastewater infiltration trench(es) must meet applicable standards for conventional or alternative onsite wastewater systems.~~

~~(4)(b) There shall be a replacement area equivalent to at least fifty (50) percent in size of the original system area held in reserve for system repair. This area shall have a suitable configuration, and shall meet the minimum soil and site conditions of ~~R. 61-56~~ R.61-56.~~

~~(5)(c) This system cannot be considered for facilities with peak flow rates in excess of fifteen hundred (1500) gallons per day-gpd unless the trench width is three (3) feet and the aggregate depth is between fourteen (14) and twenty-eight (28) inches.~~

~~(6)(d) The linear footage requirement for an alternative width and depth system shall be determined by first figuring the conventional (36 inch wide with 14 inch aggregate depth) linear footage requirements and then multiplying by the appropriate factor based on desired trench width and aggregate depth. (See table below system illustration for multiplication factors.)~~

<b>FACTORS (F) FOR MAINTAINING EQUIVALENT INFILTRATIVE SURFACE AREA</b>						
<b>TRENCH WIDTH (ft.)</b>	<b>AGGREGATE DEPTH (in.)</b>					
	<b>6"*</b>	<b>9"**</b>	<b>14"</b>	<b>20"</b>	<b>24"</b>	<b>28"</b>
<del>XXXXXXXX</del>						
<b>1.5'</b>	2.39	1.94	1.39	1.10	0.97	0.87
<b>2.0'</b>	1.99	1.66	1.23	1.00	0.89	0.80
<b>2.5'</b>	1.71	1.46	1.10	0.91	0.82	0.75
<b>3'</b>	1.50	1.30	1.00	0.84	0.76	0.70***
<b>4'</b>	1.20	1.06	0.84	0.73	0.67	0.62
<b>5'</b>	1.00	0.89	0.73	0.64	0.59	0.55
<b>6'</b>	0.85	0.78	0.64	0.57	0.53	0.50
<b>7'</b>	0.74	0.68	0.57	0.52	0.49	0.46
<b>8'</b>	0.66	0.61	0.52	0.47	0.45	0.42
<b>9'</b>	0.59	0.55	0.47	0.43	0.41	0.39
<b>10'</b>	0.54	0.51	0.43	0.40	0.38	0.36



<b>FACTORS (F) FOR MAINTAINING EQUIVALENT INFILTRATIVE SURFACE AREA</b>						
<b>TRENCH WIDTH (ft.)</b>	<b>AGGREGATE DEPTH (in.)</b>					
<del>XXXXXXXX</del>	<b>6"*</b>	<b>9"**</b>	<b>14"</b>	<b>20"</b>	<b>24"</b>	<b>28"</b>
<b><math>F = 5.34^2 / \text{ft}^2</math></b> <b><math>2 (SwD / 12) + TW</math></b> <b>* Factor reflects 12 percent increase</b> <b>** Factor reflects 9 percent increase</b> <b>*** Use system code 360/380</b>			Where, $5.34 \text{ ft}^2/\text{ft}$ = total infiltrative surface area per linear foot of conventional type trench 36 in. wide, 14 in. deep SwD = Side Wall Depth (in.) TW = Trench Width (ft)			

408.2 INSTALLATION REQUIREMENTS(2) Installation Requirements

(1)(a) Trench widths shall always be kept as narrow as possible and shall not exceed 10 feet.

(2)(b) The aggregate depth shall be between six (6) inches and twenty-eight (28) inches when considering trench widths ranging from one and one-half (1½) to ten (10) feet (see chart). The aggregate depth may be increased to a maximum of forty-two (42) inches, provided the trench width does not exceed thirty-six (36) inches (Note: ~~in~~ In these cases, the equivalency formula should be utilized to determine the appropriate factor (F) when considering aggregate depths between 28 and 42 inches). All trenches shall be covered with at least nine (9) inches of backfill.

(3)(c) Methods of construction which preclude vehicular compaction of the trench bottom must always be utilized.

408.3 FINAL LANDSCAPING AND DRAINAGE(3) Final Landscaping and Drainage

(1)(a) Installation of drainage swales, ditches, diversion drains, or rain gutters may be required to divert or intercept water away from the onsite wastewater system location. The septic tank and subsurface wastewater infiltration area shall be backfilled and shaped to promote surface water runoff.

(2)(b) A barrier to preclude parking and vehicular traffic over the area of the system may be required.

(3)(c) Following final landscaping, seeding or sodding may be required to prevent erosion.

(4)(d) Final approval shall be withheld until all landscaping and drainage improvements have been satisfactorily completed.

**SOUTH CAROLINA DEPARTMENT OF HEALTH AND ENVIRONMENTAL CONTROL  
BUREAU OF ENVIRONMENTAL HEALTH**

ALTERNATIVE SYSTEM  
ALTERNATIVE TRENCH WIDTH & DEPTH SYSTEMS

PROGRAM 362 / CODE 270 / CODE 271 IF PUMPED

**TYPICAL DESIGN ILLUSTRATION**

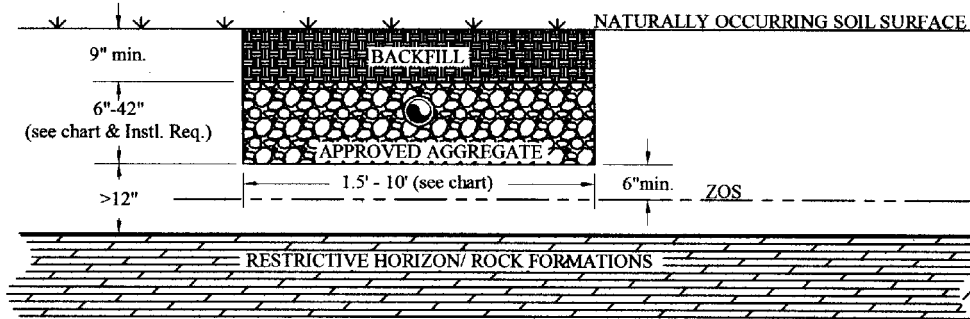

NOT TO SCALE

**FACTORS (F) FOR MAINTAINING EQUIVALENT INFILTRATIVE SURFACE AREA**

TRENCH WIDTH (ft.)	AGGREGATE DEPTH (in.)					
	6" *	9" **	14"	20"	24"	28"
1.5'	2.39	1.94	1.39	1.10	0.97	0.87
2.0'	1.99	1.66	1.23	1.00	0.89	0.80
2.5'	1.71	1.46	1.10	0.91	0.82	0.75
3.0'	1.50	1.30	1.00	0.84	0.76	0.70***
4.0'	1.20	1.06	0.84	0.73	0.67	0.62
5.0'	1.00	0.89	0.73	0.64	0.59	0.55
6.0'	0.85	0.78	0.64	0.57	0.53	0.50
7.0'	0.74	0.68	0.57	0.52	0.49	0.46
8.0'	0.66	0.61	0.52	0.47	0.45	0.42
9.0'	0.59	0.55	0.47	0.43	0.41	0.39
10.0'	0.54	0.51	0.43	0.40	0.38	0.36

$$F = \frac{5.34 \text{ sqft. / ft}}{2(\text{SwD} / 12) + \text{TW}}$$

\* Factors (F) reflect 12% increase  
 \*\* Factors (F) reflect 9% increase  
 \*\*\* Use system code 360/380  
 (See notes in text)

Where, 5.34 sqft/ft = total infiltrative surface area per linear foot of conventional type trench ( 36in. wide, 14in. deep)  
 SwD = Side Wall Depth (in)  
 TW = Trench Width (ft.)

TLE REV. 05/15/07

**SOUTH CAROLINA DEPARTMENT OF HEALTH AND ENVIRONMENTAL CONTROL  
BUREAU OF ENVIRONMENTAL HEALTH SERVICES**

ALTERNATIVE STANDARD  
ALTERNATIVE TRENCH WIDTH & DEPTH SYSTEMS

PROGRAM 362 / CODE 270 / CODE 271 IF PUMPED

**TYPICAL DESIGN ILLUSTRATION**

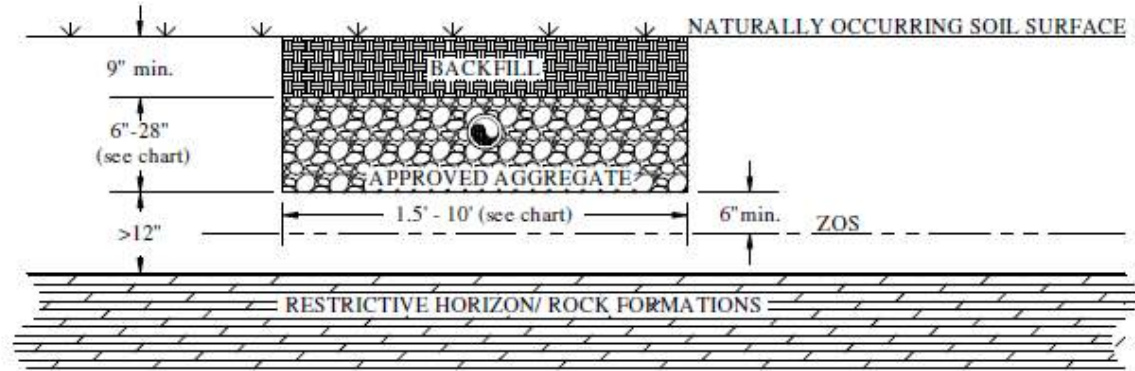

NOT TO SCALE

**FACTORS (F) FOR MAINTAINING EQUIVALENT INFILTRATIVE SURFACE AREA**

TRENCH WIDTH (ft.)	AGGREGATE DEPTH (in.)					
	6" *	9" **	14"	20"	24"	28"
1.5'	2.39	1.94	USE LTAR STANDARD	1.10	0.97	0.87
2.0'	1.99	1.66	USE LTAR STANDARD	1.00	0.89	0.80
2.5'	1.71	1.46	USE LTAR STANDARD	0.91	0.82	0.75
3.0'	1.50	1.30	USE LTAR STANDARD	0.84	0.76	0.70 <small>see system 360/380</small>
4.0'	1.20	1.06	0.84	0.73	0.67	0.62
5.0'	1.00	0.89	0.73	0.64	0.59	0.55
6.0'	0.85	0.78	0.64	0.57	0.53	0.50
7.0'	0.74	0.68	0.57	0.52	0.49	0.46
8.0'	0.66	0.61	0.52	0.47	0.45	0.42
9.0'	0.59	0.55	0.47	0.43	0.41	0.39
10.0'	0.54	0.51	0.43	0.40	0.38	0.36

$$F = \frac{5.33 \text{ sqft. / ft}}{2 (SwD / 12) + TW}$$

\* Factors (F) reflect 12% increase  
\*\* Factors (F) reflect 9% increase  
(See notes in text)

Where, 5.33 sqft/ft = total infiltrative surface area per linear foot of conventional type trench (36in. wide, 14in. deep)

SwD = Side Wall Depth (in)  
TW = Trench Width (ft.)

Rev. 03/09/18

~~409 APPENDIX I SYSTEM STANDARD 280/281 RESERVOIR INFILTRATION SYSTEM FOR SOILS WITH EXPANSIVE CLAY SHALLOW ROCK FORMATIONS~~ **Appendix J - System Standard 280/281 - Reservoir Infiltration System for Soils with Expansive Clay Shallow Rock Formations**

~~409.1 SITE/PERMITTING REQUIREMENTS~~ (1) Site/Permitting Requirements

~~(1)(a)~~ Rock formations must be rippable (see ~~Section 409.1(9)(b)~~ Appendix J, paragraph (1)(i)(ii)) to a depth greater than four (4) feet below the naturally occurring soil surface.

~~(2)(b)~~ The soil wastewater infiltration trenches must penetrate the saprolite at least six (6) inches, and there must be an offset greater than twelve (12) inches between the trench bottoms and any rock formations (i.e., there must be at least six (6) inches of clean, unconsolidated saprolite below the expansive clay layer, and medium sand may be added to the excavation to achieve an offset from rock that exceeds twelve (12) inches).

~~(3)(c)~~ There must be no evidence of a zone of saturation (ZOS) in the unconsolidated saprolite layer.

~~(4)(d)~~ The ~~Long Term Acceptance Rate~~ long term acceptance rate shall not exceed 0.20-gpd/sqft.

~~(5)(e)~~ Effluent discharged to this system must receive a higher degree of treatment than that provided by a conventional septic tank- (i.e., e.g., two compartment septic tank or two septic tanks in series).

~~(6)(f)~~ There shall be a replacement area equivalent to at least fifty (50) percent in size of the original system area held in reserve for system repair. This area shall have a suitable configuration, and shall meet the minimum soil and site conditions of ~~R. 61-56~~ R.61-56.

~~(7)(g)~~ No part of this system can be installed within one hundred twenty-five (125) feet of the ordinary high water elevation within the banks of environmentally sensitive waters.

~~(8)(h)~~ Sites to be considered for this system shall be evaluated using backhoe pits to describe the soil profile.

~~(9)(i)~~ This system cannot be considered for facilities with peak flow rates in excess of fifteen hundred (1500) gallons per day gpd.

~~(a)(i)~~ Clean, unconsolidated saprolite shall be defined as: ~~Soft soft~~, friable thoroughly decomposed rock that has formed in place by chemical weathering, retaining the fabric and structure of the parent rock, and being devoid expansive clay. Unconsolidated saprolite can be dug using a hand auger or knife. Consolidated saprolite cannot be penetrated with a hand auger or similar tool, and must be dug with a backhoe or other powered equipment.

~~(b)~~ Rippable rock shall be defined as formations that can be readily dug with a standard rubber-tired backhoe.

~~(e)(ii)~~ Expansive clay shall be defined as soils containing significant amounts of expansible-layer clay minerals (smectites) as evidenced in the field by classifications of Very Sticky and Very Plastic and Structure Grades of Weak or Structureless when evaluated in accordance with the Field Books. Such soils are considered to be unsuitable for onsite wastewater systems.

~~409.2 INSTALLATION REQUIREMENTS~~ (2) Installation Requirements

~~\_\_~~(1)(a) The ~~aggregate~~ depth of approved aggregate shall be at least twenty-four (24) inches.

~~\_\_~~(2)(b) The trench width shall be thirty-six (36) inches.

~~\_\_~~(3)(c) Where gravity flow from the septic tank to the subsurface wastewater infiltration area is utilized, the invert elevation of the septic tank outlet shall be installed at an elevation at least equal to or higher than the top of the aggregate in the highest wastewater infiltration trench(es).

~~\_\_~~ 409.3 ~~FINAL LANDSCAPING AND DRAINAGE~~(3) Final Landscaping and Drainage

~~\_\_~~(1)(a) On sites where there is evidence of a zone of saturation at the soil-expansive clay interface, a curtain drain must be placed upslope along a contour and must extend the entire length of the subsurface wastewater infiltration area. The curtain drain shall extend a minimum of six (6) inches into the expansive clay layer. ~~Also, the~~ The septic tank and subsurface wastewater infiltration area shall be backfilled and shaped to promote surface water runoff.

~~\_\_~~(2)(b) Final approval shall be withheld until all landscaping, drainage, and other requirements have been satisfactorily completed.

~~\_\_~~(3)(c) Following final landscaping, seeding or sodding may be required to prevent erosion.

~~\_\_~~(4)(d) Final approval shall be withheld until all landscaping and drainage improvements have been satisfactorily completed.

**SOUTH CAROLINA DEPARTMENT OF HEALTH AND ENVIRONMENTAL CONTROL  
BUREAU OF ENVIRONMENTAL HEALTH**

ALTERNATIVE SYSTEM  
RESERVOIR INFILTRATION SYSTEM FOR SOILS WITH EXPANSIVE CLAY  
OVER SHALLOW ROCK FORMATIONS

PROGRAM 362 / CODE 280 / CODE 281 IF PUMPED

**TYPICAL DESIGN ILLUSTRATION**

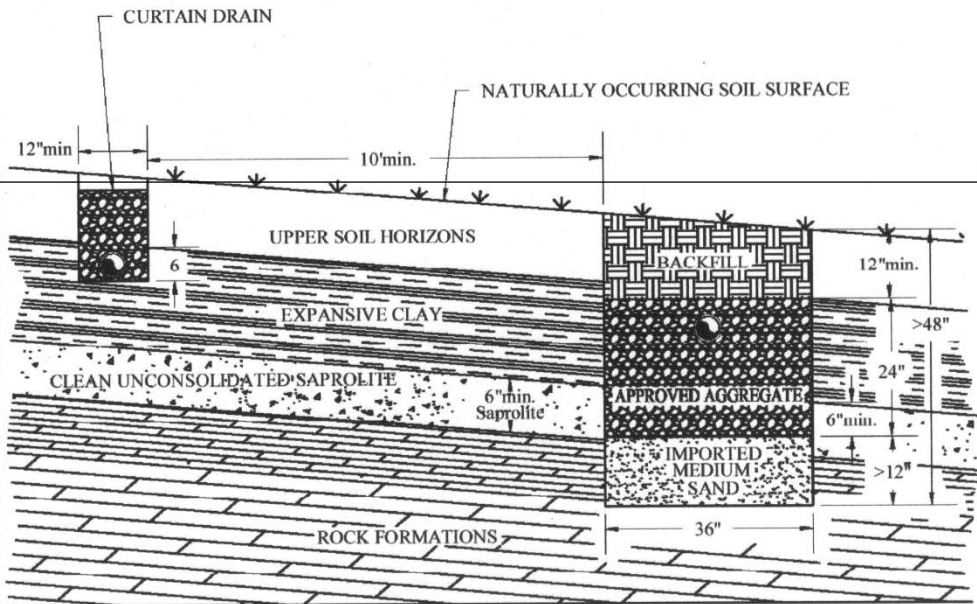

NOT TO SCALE

TLS REV 03/09/97

SOUTH CAROLINA DEPARTMENT OF HEALTH AND ENVIRONMENTAL CONTROL  
BUREAU OF ENVIRONMENTAL HEALTH SERVICES

ALTERNATIVE SYSTEM  
RESERVOIR INFILTRATION SYSTEM FOR SOILS WITH EXPANSIVE CLAY  
OVER SHALLOW ROCK FORMATIONS

PROGRAM 362 / CODE 280 / CODE 281 IF PUMPED

TYPICAL DESIGN ILLUSTRATION

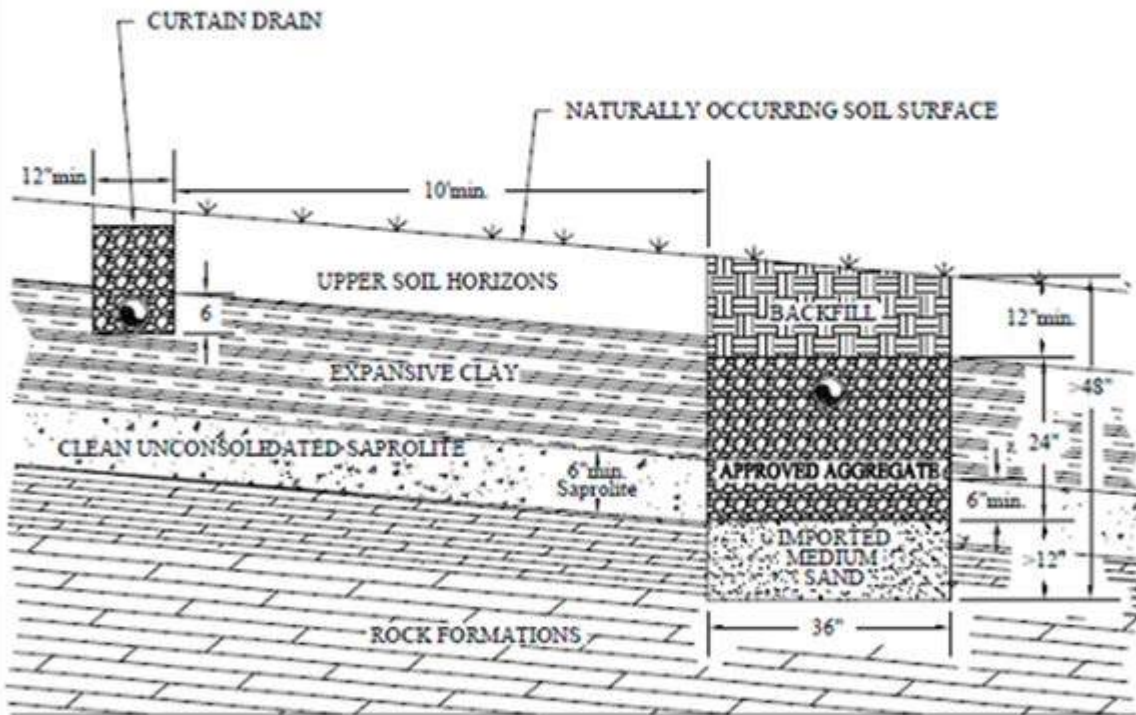

NOT TO SCALE  
Rev. 03/09/18

## **Appendix K - System Standard 290/291 - Alternative Trench Width and Depth Systems Cap**

### (1) Site/Permitting Requirements

(a) The depth to any restrictive horizon must be greater than twelve (12) inches below the bottom of the proposed wastewater infiltration trenches.

(b) The texture in the upper eighteen (18) inches of naturally occurring soil must be no more limiting than Class III.

(c) Soil conditions, the depth to rock and other restrictive horizons, the depth to the zone of saturation (ZOS), and the elevation differential between the septic tank outlet and the highest wastewater infiltration trench(es) must meet applicable standards for alternative onsite wastewater systems.

(d) There shall be a replacement area equivalent to at least fifty (50) percent in size of the original system area held in reserve for system repair. This area shall have a suitable configuration and shall meet the minimum soil and site conditions of R.61-56.

(e) This system cannot be considered for facilities with peak flow rates in excess of six hundred (600) gpd.

(f) The linear footage requirement for an alternative width and depth system shall be determined by first figuring the conventional (36-inch-wide with 14-inch aggregate depth) linear footage requirements and then multiplying by the appropriate factor based on desired trench width and aggregate depth as computed in the following table:

<b>FACTOR (F) FOR MAINTAINING EQUIVALENT INFILTRATIVE SURFACE AREA</b>			
<b>TRENCH WIDTH (ft.)</b>	<b>AGGREGATE DEPTH (in.)</b>		<b># OF DISTRIBUTION PIPES</b>
	<b>6" *</b>	<b>9" **</b>	
	<b>MULTIPLICATION FACTOR</b>		
<b>4'</b>	1.20	1.06	1
<b>5'</b>	1.00	0.89	1
<b>6'</b>	0.85	0.78	2
<b>7'</b>	0.74	0.68	2
<b>8'</b>	0.66	0.61	2
<b>9'</b>	0.59	0.55	3
<b>10'</b>	0.54	0.51	3
* Factors reflect a twelve (12) percent increase			
** Factors reflect a nine (9) percent increase			

(g) This system may only be installed on sites where the long term acceptance rate (LTAR) for the system will be between 1.0 and 0.5 gpd per foot squared (gpd/ft<sup>2</sup>). The bottom of the absorption field cannot be installed in Class IV soils (0.4 to 0.1 LTAR).

(h) The distribution pipes in the bed shall be at least eighteen (18) inches from the edge of the trench and located on three (3) foot centers.



(h) This system must not be used on slightly sloping sites that require serial distribution unless it can be demonstrated that the entire wastewater infiltration trench installation (i.e., side wall to side wall and end to end) can meet the required textural limitations and the required offsets to the zone of saturation and restrictive horizons.

(i) The long term acceptance rate for system sizing shall be based upon the most hydraulically limiting naturally occurring soil texture from the ground surface to twelve (12) inches below the bottom of the proposed wastewater infiltration trenches.

## (2) Installation Requirements

(a) Trench widths shall not exceed ten (10) feet.

(b) Wide trenches should be installed by excavating from the sides. Heavy equipment, such as backhoes, may not be placed in the trenches in order to avoid soil compaction.

(c) The required fill cap must extend at least five (5) feet beyond the limits of the wastewater infiltration trenches and must taper to the original soil surface at a slope not to exceed ten (10) percent. On sloping sites, where serial distribution has been incorporated into the system design, on the lower side and ends of the wastewater infiltration trenches, the fill cap must extend to at least ten (10) feet beyond the limits of the wastewater infiltration trenches and must taper to the original soil surface at a slope not to exceed five (5) percent. The required property line setback shall be measured from the point at which the fill cap taper intersects with the naturally occurring soil surface. The fill cap must be installed prior to beginning trench installation when required on the construction permit.

## (3) Final Landscaping and Drainage

(a) Installation of drainage swales, ditches, diversion drains, or rain gutters may be required to divert or intercept water away from the onsite wastewater system location. The septic tank and subsurface wastewater infiltration area shall be backfilled and shaped to promote surface water runoff.

(b) A barrier to preclude parking and vehicular traffic over the area of the system may be required.

(c) Following final landscaping, seeding, or sodding may be required to prevent erosion.

**SOUTH CAROLINA DEPARTMENT OF HEALTH AND ENVIRONMENTAL CONTROL  
BUREAU OF ENVIRONMENTAL HEALTH SERVICES**

**ALTERNATIVE STANDARD  
ALTERNATIVE TRENCH WIDTH & DEPTH SYSTEMS**

PROGRAM 362 / CODE 290 / CODE 291 IF PUMPED

**TYPICAL DESIGN ILLUSTRATION**

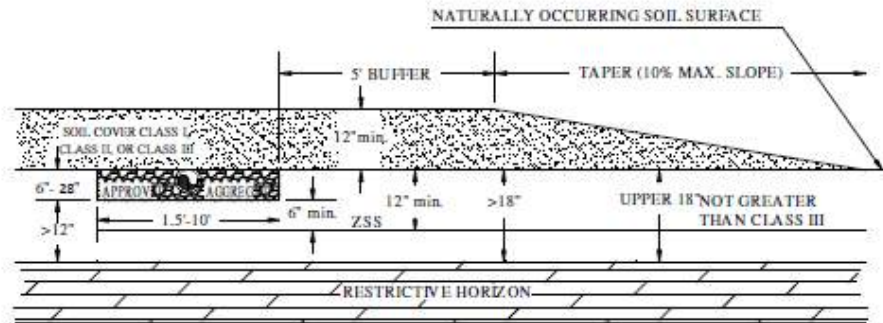

NOT TO SCALE

**FACTORS (F) FOR MAINTAINING EQUIVALENT INFILTRATIVE SURFACE AREA**

TRENCH WIDTH (ft.)	AGGREGATE DEPTH (in.)					
	6" *	9" **	14"	20"	24"	28"
1.5'	2.39	1.94	USE LTAR STANDARD	1.10	0.97	0.87
2.0'	1.99	1.66	USE LTAR STANDARD	1.00	0.89	0.80
2.5'	1.71	1.46	USE LTAR STANDARD	0.91	0.82	0.75
3.0'	1.50	1.30	USE LTAR STANDARD	0.84	0.76	0.70 <small>see system 360/380</small>
4.0'	1.20	1.06	0.84	0.73	0.67	0.62
5.0'	1.00	0.89	0.73	0.64	0.59	0.55
6.0'	0.85	0.78	0.64	0.57	0.53	0.50
7.0'	0.74	0.68	0.57	0.52	0.49	0.46
8.0'	0.66	0.61	0.52	0.47	0.45	0.42
9.0'	0.59	0.55	0.47	0.43	0.41	0.39
10.0'	0.54	0.51	0.43	0.40	0.38	0.36

$$F = \frac{5.33 \text{ sqft. / ft}}{2 (\text{SwD} / 12) + \text{TW}}$$

\* Factors (F) reflect 12% increase  
\*\* Factors (F) reflect 9% increase  
(See notes in text)

Where, 5.33 sqft/ft = total infiltrative surface area per linear foot of conventional type trench ( 36in. wide, 14in. deep)

SwD = Side Wall Depth (in)

TW = Trench Width (ft.)

Rev. 03/09/18

~~410 APPENDIX J SYSTEM STANDARD 370/371 SHALLOW PLACEMENT WITH FILL CAP FOR SITES WITH SHALLOW CLASS IV SOIL~~ **Appendix L - System Standard 370/371 - Shallow Placement with Fill Cap for Sites with Shallow Class IV Soil**

~~410.1 SITE/PERMITTING REQUIREMENTS~~ (1) Site/Permitting Requirements

~~(1)(a)~~ There must not be a zone of saturation (ZOS) within twelve (12) inches of the naturally occurring soil surface.

~~(2)(b)~~ The depth to any restrictive horizon must be greater than twelve (12) inches below the bottom of the proposed wastewater infiltration trenches.

~~(3)(c)~~ This system must not be utilized on sites that require serial distribution. Level installations on slightly sloping sites can be considered if it can be demonstrated that the entire installation (i.e., side wall to side wall and end to end) will meet the required textural limitations and the required offsets to the zone of saturation and restrictive horizons.

~~(4)(d)~~ No part of this system can be installed within 125 feet of the ordinary high water elevation within the banks of environmentally sensitive waters.

~~(5)(e)~~ This system may be considered for installation on contiguous lots in new subdivisions approved after the effective date of this standard provided a setback of at least seventy-five (75) feet is maintained between the system and all adjacent property lines. The seventy-five (75) foot setback shall be measured from the point at which the fill cap taper intersects with the naturally occurring soil surface.

~~(6)(f)~~ This system cannot be considered for facilities with peak sewage flow rates in excess of four hundred eighty (480) ~~gallons per day gpd~~. In addition, this system shall not be considered for facilities requiring grease traps.

~~(7)(g)~~ There shall be a replacement area equivalent to at least fifty (50) percent in size of the original system area held in reserve for system repair. This area shall have a suitable configuration, and shall meet the minimum soil and site conditions of ~~R. 61-56~~ R.61-56.

~~(8)(h)~~ The ~~Long Term Acceptance Rate~~ long term acceptance rate for system sizing shall be based upon the most hydraulically limiting naturally occurring soil texture from the ground surface to twelve (12) inches below the bottom of the proposed wastewater infiltration trenches.

~~410.2 INSTALLATION REQUIREMENTS~~ (2) Installation Requirements

~~(1)(a)~~ This system cannot utilize serial distribution.

~~(2)(b)~~ Effluent discharged to this system must receive a higher degree of treatment than that provided by a conventional septic tank (~~i.e., e.g.~~ two compartment septic tank or two septic tanks in series).

~~(3)(c)~~ Where gravity flow from the septic tank to the subsurface wastewater infiltration area is utilized, the invert elevation of the septic tank outlet shall be installed at an elevation at least equal to or higher than the top of the aggregate in the highest wastewater infiltration trench(es).

~~(4)(d)~~ The required fill cap must extend at least five (5) feet beyond the limits of the wastewater infiltration trenches, and it must taper to the original soil surface at a slope not to exceed 10 percent (~~see attached sketch~~). The required seventy-five (75) feet property line setback shall be measured from the point at which the fill cap taper intersects with the naturally occurring soil surface.

~~\_\_(5)(e)~~ The required fill material must be soil texture Class I, Class II or Class III and be void of extraneous debris such as organic matter, building materials, etc.

~~\_\_(6)(f)~~ The depth of the fill cap shall provide a minimum of twelve (12) inches backfill above the top of the wastewater infiltration trench aggregate.

~~\_\_(7)(g)~~ The wastewater infiltration trench width shall be thirty-six (36) inches

~~\_\_(8)(h)~~ All tree and brush removal shall be done in a manner that minimizes the disturbance or loss of naturally occurring soil.

~~(9)~~ The following criteria shall be utilized in the selection and design of these systems:

<del>Depth to ZOS (Inches)</del>	<del>Depth to Class IV (Inches)</del>	<del>Amount of Imported Fill Cap/Aggregate Depth (Inches)</del>	<del>Extension Factor</del>
<del>12</del>	<del>18</del>	<del>12/6</del>	<del>1.5</del>
<del>13</del>	<del>17</del>	<del>12/6</del>	<del>1.5</del>
<del>14</del>	<del>16</del>	<del>12/6</del>	<del>1.5</del>
<del>15</del>	<del>15</del>	<del>12/9</del>	<del>1.3</del>
<del>16</del>	<del>14</del>	<del>12/9</del>	<del>1.3</del>
<del>17</del>	<del>13</del>	<del>12/9</del>	<del>1.3</del>
<del>18</del>	<del>12</del>	<del>12/9</del>	<del>1.3</del>
<del>19</del>	<del>11</del>	<del>12/9</del>	<del>1.3</del>
<del>20</del>	<del>10</del>	<del>12/9</del>	<del>1.3</del>

Note: refer to the design sketch (typical) for detail.

~~\_\_410.3 FINAL LANDSCAPING AND DRAINAGE(3) Final Landscaping and Drainage~~

~~\_\_(1)(a)~~ The septic tank and fill cap area shall be backfilled and shaped to promote the runoff of surface water.

~~\_\_(2)(b)~~ Where natural surface drainage does not exist, a swale shall be constructed adjacent to the filled area to divert surface water away from the onsite wastewater system to a positive outfall. The installation of ditches, curtain drains, and rain gutters may be required to intercept and divert water away from the onsite wastewater system location.

~~\_\_(3)(c)~~ A barrier to preclude parking and vehicular traffic over the system area may be required.

~~\_\_(4)(d)~~ Following final landscaping, seeding or sodding may be required to prevent erosion.

~~\_\_(5)(e)~~ Final approval shall be withheld until all landscaping and drainage improvements have been satisfactorily completed.

**SOUTH CAROLINA DEPARTMENT OF HEALTH AND ENVIRONMENTAL CONTROL  
BUREAU OF ENVIRONMENTAL HEALTH**

ALTERNATIVE SYSTEM  
SHALLOW PLACEMENT SYSTEM WITH FILL CAP FOR SITES WITH SHALLOW CLASS IV SOILS  
PROGRAM 362 / CODE 370 / CODE 371 IF PUMPED

**TYPICAL DESIGN ILLUSTRATION**

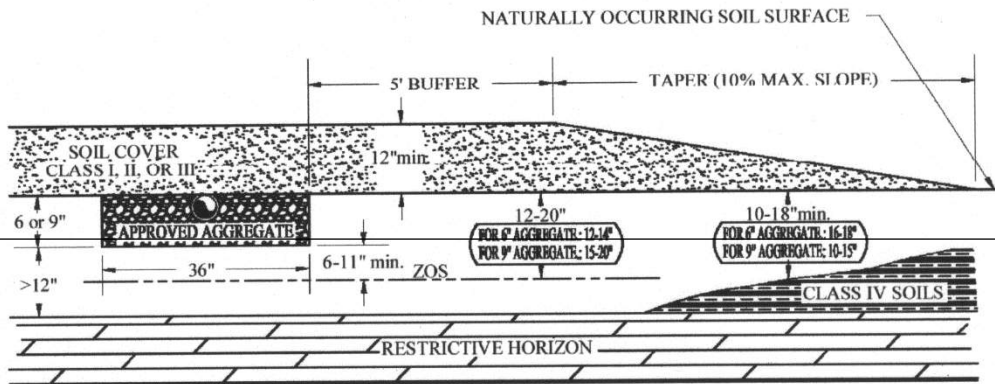

Depth to ZOS (in)	Depth to Class IV Soil (in)	Amount of Imported Fill Cap / Aggregate Depth (in)	Extension Factor
12	18	12 / 6	1.5
13	17	12 / 6	1.5
14	16	12 / 6	1.5
---	---	---	---
15	15	12 / 9	1.3
16	14	12 / 9	1.3
17	13	12 / 9	1.3
18	12	12 / 9	1.3
19	11	12 / 9	1.3
20	10	12 / 9	1.3

NOT TO SCALE

TLS REV. 03/10/07

**SOUTH CAROLINA DEPARTMENT OF HEALTH AND ENVIRONMENTAL CONTROL  
BUREAU OF ENVIRONMENTAL HEALTH SERVICES**

**ALTERNATIVE STANDARD  
SHALLOW PLACEMENT SYSTEM WITH FILL CAP FOR SITES WITH SHALLOW CLASS IV SOILS  
PROGRAM 362 / CODE 370 / CODE 371 IF PUMPED**

**TYPICAL DESIGN ILLUSTRATION**

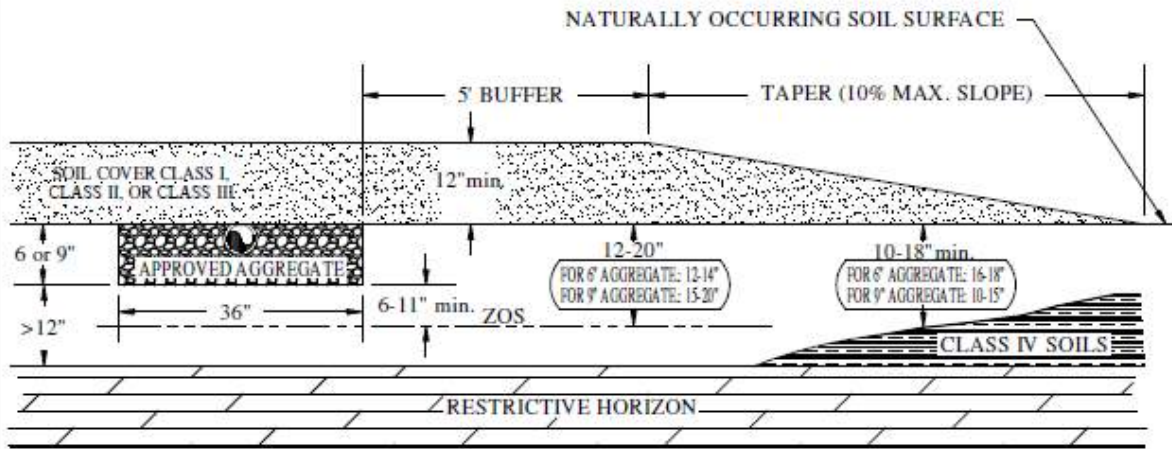

NOT TO SCALE

Depth to ZSS (in)	Depth to Class IV Soil (in)	Amount of Imported Fill Cap / Aggregate Depth (in)	Extension Factor
12	18	12 / 6	1.5
13	17	12 / 6	1.5
14	16	12 / 6	1.5
---	---	---	---
15	15	12 / 9	1.3
16	14	12 / 9	1.3
17	13	12 / 9	1.3
18	12	12 / 9	1.3
19	11	12 / 9	1.3
20	10	12 / 9	1.3

Rev. 03/09/18

~~411 APPENDIX K - System Standard 380/381 - DOUBLE AGGREGATE DEPTH WASTEWATER INFILTRATION TRENCHES~~ **Appendix M - System Standard 380/381 - Double Aggregate Wastewater Infiltration Trenches**

~~\_\_411.1 SITE/PERMITTING REQUIREMENTS~~ (1) Site/Permitting Requirements

~~\_\_(1)(a)~~ Use of the double aggregate depth option must be restricted to soils that meet all textural limitations and required offsets to the zone of saturation (ZOS) and restrictive horizons.

~~\_\_(2)(b)~~ Systems incorporating the double aggregate depth option shall be loaded on the basis of the most hydraulically limiting naturally occurring soil texture from the ground surface to twelve (12) inches below the bottom of the proposed wastewater infiltration trenches.

~~\_\_(3)(c)~~ In order to maintain the same total absorptive area as that provided by conventional aggregate depth systems, the equivalent linear footage requirement for thirty-six (36) inch wide double aggregate depth trenches shall be determined by multiplying the conventional trench requirement by a factor of 0.7.

~~\_\_(4)(d)~~ There shall be a replacement area equivalent to at least fifty (50) percent in size of the original system area held in reserve for system repair. This area shall have a suitable configuration, and shall meet the minimum soil and site conditions of ~~R. 61-56~~ R.61-56.

~~\_\_411.2 INSTALLATION REQUIREMENTS~~ (2) Installation Requirements

~~\_\_(1)(a)~~ The wastewater infiltration trench aggregate shall be twenty-eight (28) inches in depth, and shall be placed so as to provide twenty (20) inches of aggregate below the pipe, five (5) inches beside the pipe, and three (3) inches above the pipe. The aggregate shall be covered with at least nine (9) inches of backfill.

~~\_\_(2)(b)~~ The wastewater infiltration trench width shall be thirty-six (36) inches.

~~\_\_(3)(c)~~ Where gravity flow from the septic tank to the subsurface wastewater infiltration area is utilized, the invert elevation of the septic tank outlet shall be installed at an elevation at least equal to or higher than the top of the aggregate in the highest wastewater infiltration trench(es).

~~\_\_411.3 FINAL LANDSCAPING AND DRAINAGE~~ (3) Final Landscaping and Drainage

~~\_\_(1)(a)~~ Installation of drainage swales, ditches, curtain drains, and rain gutters may be required to divert or intercept water away from the onsite wastewater system location. The septic tank and subsurface wastewater infiltration area shall be backfilled and shaped to promote surface water runoff.

~~\_\_(2)(b)~~ Following final landscaping, seeding or sodding may be required to prevent erosion.

~~\_\_(3)(c)~~ Final approval shall be withheld until all landscaping and drainage improvements have been satisfactorily completed.

**SOUTH CAROLINA DEPARTMENT OF HEALTH AND ENVIRONMENTAL CONTROL  
BUREAU OF ENVIRONMENTAL HEALTH**

ALTERNATIVE SYSTEM  
DOUBLE AGGREGATE DEPTH SOIL ABSORPTION TRENCHES

PROGRAM 360 / CODE 380 / CODE 381 IF PUMPED

**TYPICAL DESIGN ILLUSTRATION**

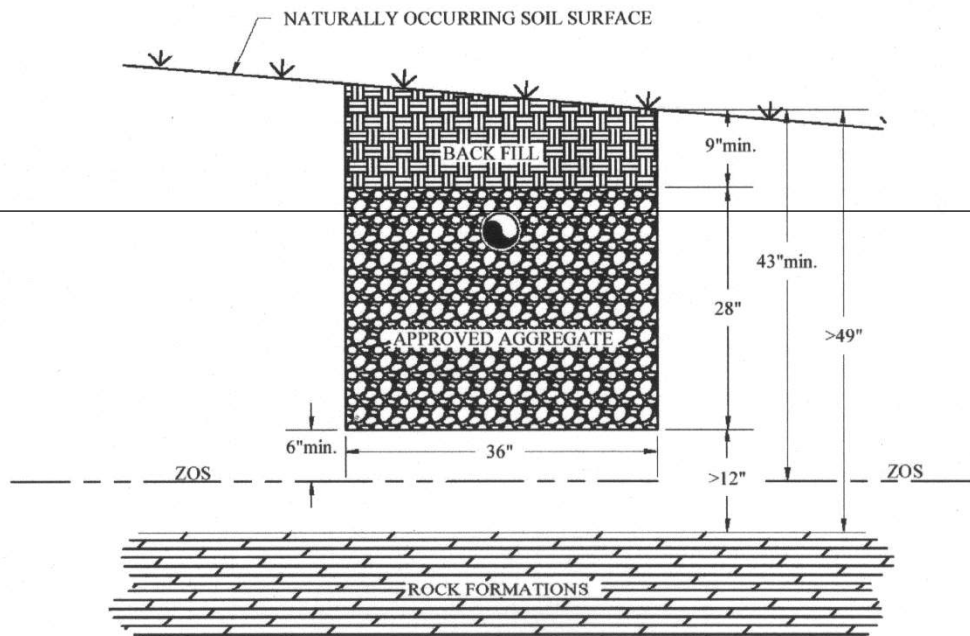

SCALE: 3/4"=1'

TDS REV. 02/10/07



SOUTH CAROLINA DEPARTMENT OF HEALTH AND ENVIRONMENTAL CONTROL  
BUREAU OF ENVIRONMENTAL HEALTH SERVICES

ALTERNATIVE STANDARD  
DOUBLE AGGREGATE DEPTH SOIL ABSORPTION TRENCHES

PROGRAM 360 / CODE 380 / CODE 381 IF PUMPED

TYPICAL DESIGN ILLUSTRATION

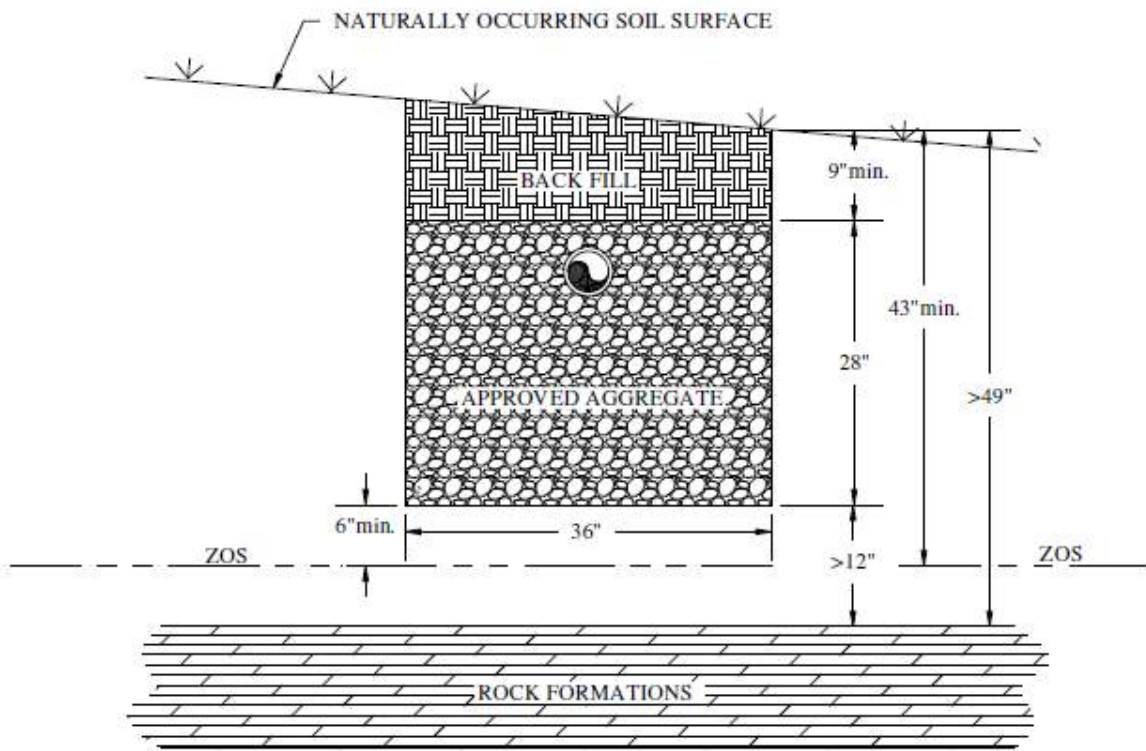

NOT TO SCALE

Rev. 03/09/18

412 APPENDIX L — System Standard 420/421 — MOUNDED INFILTRATION SYSTEM **Appendix N -  
System Standard 420/421 - Mounded Infiltration System**

~~412.1~~ SITE/PERMITTING REQUIREMENTS (1) Site/Permitting Requirements

~~\_\_ (1)(a)~~ The texture in the upper twelve (12) inches of naturally occurring soil must be Class I or Class II.

~~\_\_ (2)(b)~~ The soil texture in the permeable substratum must be no more limiting than Class II.

~~\_\_ (3)(c)~~ There must not be a zone of saturation (ZOS) within six (6) inches of the naturally occurring soil surface.

~~\_\_ (4)(d)~~ The depth to any restrictive horizon must be greater than twelve (12) inches below the bottom of the proposed wastewater infiltration trenches.

~~\_\_ (5)(e)~~ There shall be a replacement area equivalent to at least fifty (50) percent in size of the original system area held in reserve for system repair. This area shall have a suitable configuration, and shall meet the minimum soil and site conditions of ~~R-61-56~~ R.61-56.

~~\_\_ (6)(f)~~ Prior to permitting the onsite wastewater system, delineation of any affected jurisdictional wetlands may be required. Should any part of the proposed onsite wastewater system be located in jurisdictional wetlands, approval from the appropriate permitting agency(s) (i.e., e.g., US Army Corp. of Engineers, SCDHEC OCRM, etc.) shall be received; and proof of such provided to the Department.

~~\_\_ (7)(g)~~ No part of this system can be installed within 125 feet of the critical area line or tidal waters as determined by the Department; or within 125 feet of the ordinary high water elevation within the banks of non-tidal, environmentally sensitive waters.

~~\_\_ (8)(h)~~ This system cannot be considered for facilities with peak flow rates in excess of four hundred eighty (480) ~~gallons per day-gpd.~~ In addition, this system shall not be considered for facilities requiring grease traps.

~~\_\_ (9)(i)~~ This system may not be installed on sites that flood.

~~\_\_ (10)(j)~~ This system must not be utilized on sites that require serial distribution. Level installations on slightly sloping sites can be considered if it can be demonstrated that the entire installation (i.e., side wall to side wall and end to end) will meet the required textural limitations and the required offsets to the zone of saturation and restrictive horizons.

~~\_\_ (11)(k)~~ The total linear footage of six (6) inch deep, thirty-six (36) inch wide wastewater infiltration trenches shall be increased by 100 percent over that which would be required for conventional trenches, as determined by the ~~Long-Term Acceptance Rate~~ long term acceptance rate of the permeable substratum.

~~\_\_ (12)(l)~~ This system may be considered for installation on contiguous lots in new subdivisions approved after the effective date of this standard provided a setback of at least seventy-five (75) feet is maintained between the system and all adjacent property lines. The seventy-five (75) foot setback shall be measured from the point at which the fill cap taper intersects with the naturally occurring soil surface.

~~\_\_ 412.2~~ INSTALLATION REQUIREMENTS(2) Installation Requirements

~~(1)~~(a) Site Preparation

~~(a)~~(i) The naturally occurring soil surface underlying the area of the wastewater infiltration trenches shall be thoroughly tilled and mixed with the imported medium sand to a depth of six (6) inches.

~~(b)~~(ii) All tree and brush removal shall be done in a manner that minimizes the disturbance or loss of naturally occurring soil.

~~(2)~~(b) Fill and System ~~(see ref. sketch)~~

~~(a)~~(i) The fill cap and buffer shall be Class I, Class II, or Class III.

~~(b)~~(ii) The depth of the fill cap shall provide a minimum of twelve (12) inches backfill above the top of the wastewater infiltration trench aggregate ~~(see ref. sketch)~~.

~~(c)~~(iii) Where gravity flow from the septic tank to the subsurface wastewater infiltration area is utilized, the invert elevation of the septic tank outlet shall be installed at an elevation at least equal to or higher than the top of the aggregate in the highest wastewater infiltration trench(es).

~~(d)~~(iv) The fill buffer shall be at least fifteen (15) feet in width.

~~(e)~~(v) The fill taper shall be at least twenty (20) feet in width.

~~(f)~~(vi) The required property line setback shall be measured from the point at which the fill cap taper intersects with the naturally occurring soil surface.

~~(g)~~(vii) The total fill depth, excluding the taper zone, shall be at least eighteen (18) inches above the naturally occurring soil surface.

~~(h)~~(viii) The wastewater infiltration trenches shall be installed in a Class I fill pad at least six (6) inches in depth, which extends five (5) feet beyond the trenches in all directions.

~~(i)~~(ix) The wastewater infiltration trenches require a total aggregate depth of six (6) inches.

~~(j)~~(x) The wastewater infiltration trench width shall be thirty-six (36) inches.

~~(k)~~(xi) Infiltration trenches shall penetrate the permeable substratum and shall be at least two (2) feet in width containing USDA medium sand, washed concrete sand, or other material approved by the Department.

~~(l)~~(xii) Effluent discharged to this system must receive a higher degree of treatment than that provided by a conventional septic tank ~~(i.e., e.g., two compartment septic tank or two septic tanks in series)~~.

~~412.3~~ FINAL LANDSCAPING AND DRAINAGE(3) Final Landscaping and Drainage

~~(1)~~(a) The septic tank and fill cap area shall be backfilled and shaped to promote the runoff of surface water.

~~(2)~~(b) Where natural surface drainage does not exist, a swale shall be constructed adjacent to the filled area to divert surface water away from the onsite wastewater system to a positive outfall. The installation

of ditches, curtain drains, and rain gutters may be required to intercept and divert water away from the onsite wastewater system location.

~~\_\_~~(3)(c) A barrier to preclude parking and vehicular traffic over the system area may be required.

~~\_\_~~(4)(d) Following final landscaping, seeding or sodding may be required to prevent erosion.

~~\_\_~~(5)(e) Final approval shall be withheld until all landscaping and drainage improvements have been satisfactorily completed.

**SOUTH CAROLINA DEPARTMENT OF HEALTH AND ENVIRONMENTAL CONTROL  
BUREAU OF ENVIRONMENTAL HEALTH**

ALTERNATIVE STANDARD

MOUNDED INFILTRATION SYSTEM FOR PERMEABLE SANDS UNDERLYING RESTRICTIVE HORIZONS

PROGRAM 362 / CODE 420 / CODE 421 IF PUMPED

**TYPICAL DESIGN ILLUSTRATION**

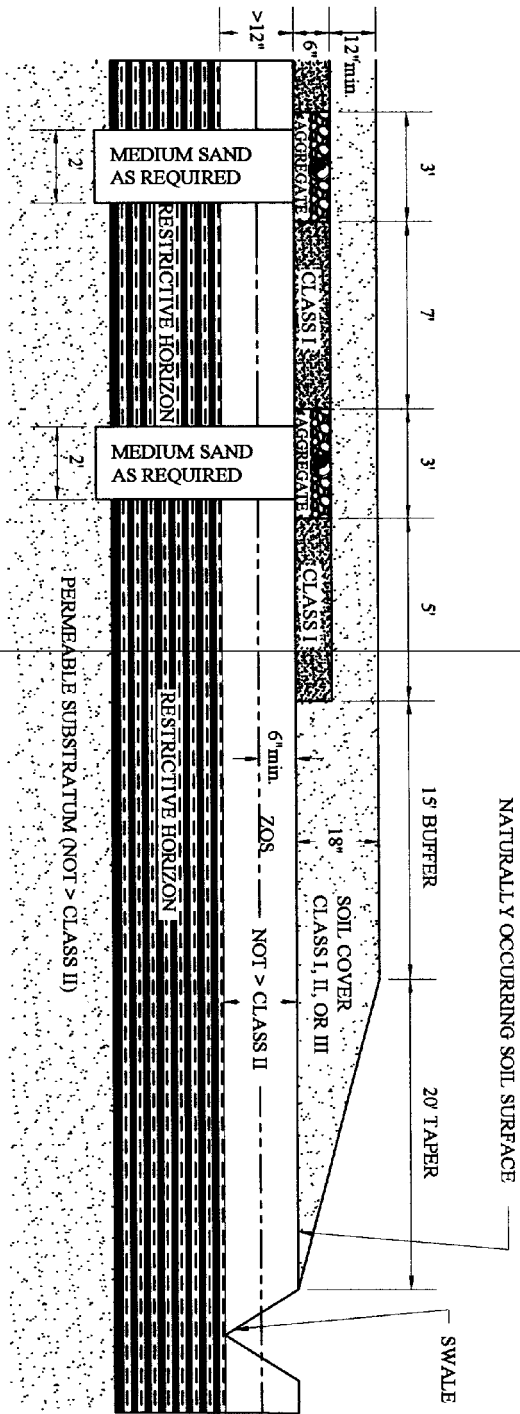

NOT TO SCALE

TIA REV. 6/23/04



413 APPENDIX M System Standard 431 MOUNDED FILL SYSTEM **Appendix D - System Standard 431 - Mounded Fill System**

413.1 SITE/PERMITTING REQUIREMENTS(1) Site/Permitting Requirements

- (1)(a) This system shall not be used on sites that are subject to flooding.
- (2)(b) The texture in the upper eighteen (18) inches of naturally occurring soil must be Class I or Class II.
- (3)(c) The absorption bed within the mound shall be sized on the ~~Long Term Acceptance Rate~~ long term acceptance rate of the most limiting texture in the upper eighteen (18) inches of naturally occurring soil.
- (4)(d) The linear footage of the absorption bed shall be determined in accordance with Standard 270.
- (5)(e) The absorption bed width shall be a minimum of five (5) feet and a maximum of 10 feet.
- (6)(f) Mounded fill systems must not be placed on sites with a slope in excess of three (3) percent.
- (7)(g) No part of this system can be installed within 125 feet of the critical area line or tidal waters as determined by the Department; or within 125 feet of the ordinary high water elevation within the banks of non-tidal, environmentally sensitive waters. Because of the long buffer, side slope, fill pad, and taper associated with this system, the one hundred twenty-five (125) foot setback shall be measured from the outer edge of the aggregate bed within the mound.
- (8)(h) There shall be a replacement area equivalent to at least fifty (50) percent in size of the original system area held in reserve for system repair. This area shall have a suitable configuration, and shall meet the minimum soil and site conditions of ~~R. 61-56~~ R.61-56.
- (9)(i) Prior to permitting the onsite wastewater system, delineation of any affected jurisdictional wetlands may be required. Should any part of the proposed onsite wastewater system be located in jurisdictional wetlands, approval from the appropriate permitting agency(s) (i.e., e.g., US Army Corp. of Engineers, SCDHEC Ocean and Coastal Resource Management, etc.) shall be received and proof of such provided to the Department.
- (10)(j) This system cannot be considered for facilities with peak flow rates in excess of four hundred eighty (480) ~~gallons per day~~ gpd. In addition, this system shall not be considered for facilities requiring grease traps.
- (11)(k) Effluent discharged to this system must receive a higher degree of treatment than that provided by a conventional septic tank (~~i.e., e.g.,~~ two compartment septic tank or two septic tanks in series).
- (12)(l) This system may be considered for installation on contiguous lots in new subdivisions approved after the effective date of this standard provided a setback of at least seventy-five (75) feet is maintained between the system and all adjacent property lines. Because of the long buffer, side slope, fill pad, and taper associated with this system, the seventy-five (75) foot setback shall be measured from the outer edge of the aggregate bed within the mound.

413.2 INSTALLATION REQUIREMENTS(2) Installation Requirements

~~(1)~~(a) Site Preparation

~~(a)~~(i) If present within eighteen (18) inches of the naturally occurring soil surface, organic material and restrictive horizons must be removed from beneath the mound and replaced with USDA medium sand, washed concrete sand, or an equivalent material approved by the Department. The replacement area must extend five (5) feet in all directions beyond the edges of the aggregate filled absorption bed.

~~(b)~~(ii) The naturally occurring soil surface underlying the mound shall be thoroughly tilled and mixed with the imported mound fill material to a depth of six (6) inches.

~~(2)~~(b) Mound/Absorption Bed Requirements

~~(a)~~(i) Low Pressure Pipe Distribution (LPP) must be utilized to preclude localized hydraulic overloading of the imported fill material and to minimize the impact on the shallow zone of seasonal saturation.

(ii) Low Pressure Pipe Distribution (LPP) must be designed and installed in accordance with Department standards or equivalent designs. The size and layout of each distribution system will vary based on the size of the filter and the needed dosing.

(iii) Pump design shall be in accordance with Department standards.

~~(b)~~(iv) There must be at least twenty-four (24) inches of medium sand placed between the naturally occurring soil surface and the bottom of the absorption bed. ~~Also, the~~ The bottom surface of the absorption bed must be placed at least twenty-four (24) inches above the zone of saturation.

~~(e)~~(v) If the slope of the site in the proposed mound area is one (1) percent or less, then the mound shall be placed on a twelve (12) inch fill pad which must extend twenty (20) feet beyond the mound in all directions. If the slope of the site in the proposed mound area is greater than one (1) percent but less than or equal to three (3) percent, then the mound shall be placed on a twelve (12) inch deep fill pad which must extend twenty (20) feet beyond the mound area on the sides of the mound; forty (40) feet beyond the mound area on the down slope side of the mound; with no fill pad required on the upslope side of the mound.

~~(d)~~(vi) The mound and fill pad material shall be USDA medium sand, washed concrete sand, or other equivalent material approved by the Department.

~~(e)~~(vii) The depth of the fill cap material above the absorption bed shall be nine (9) to fifteen (15) inches of soil texture Class II or Class III. Sod may be substituted for four (4) inches of this portion of the fill cap material. ~~(see attached illustration).~~

~~(f)~~(viii) The depth of the fill cap material above the mound side-slope, the twelve (12) inch deep fill pad, and the taper shall be at least four (4) inches of soil texture Class II or Class III. Sod may be substituted for this portion of the fill cap material. ~~(see attached illustration).~~

~~(g)~~(ix) A 1:2 maximum slope is required if the mound side-slope and taper are sodded.

~~(h)~~(x) A 1:4 maximum slope is required if the mound side-slope and taper are mulched and seeded.

(3) ~~Final Landscaping And Drainage Requirements~~ Final Landscaping and Drainage



(a) The septic tank and mound area shall be backfilled and shaped to promote the runoff of surface water.

(b) Where natural surface drainage does not exist, a swale shall be constructed adjacent to the filled area to divert surface water away from the onsite wastewater system to a positive outfall. The installation of ditches, curtain drains, and rain gutters may be required to intercept and divert water away from the onsite wastewater system location.

(c) A barrier to preclude parking and vehicular traffic over the system area may be required.

(d) Following final landscaping, seeding, or sodding may be required to prevent erosion.

(e) Final approval shall be withheld until all landscaping and drainage improvements have been satisfactorily completed.

**SOUTH CAROLINA DEPARTMENT OF HEALTH AND ENVIRONMENTAL CONTROL  
BUREAU OF ENVIRONMENTAL HEALTH**

ALTERNATIVE SYSTEM  
MOUNDED FILL SYSTEMS  
PROGRAM 362 / CODE 431

TYPICAL DESIGN ILLUSTRATION

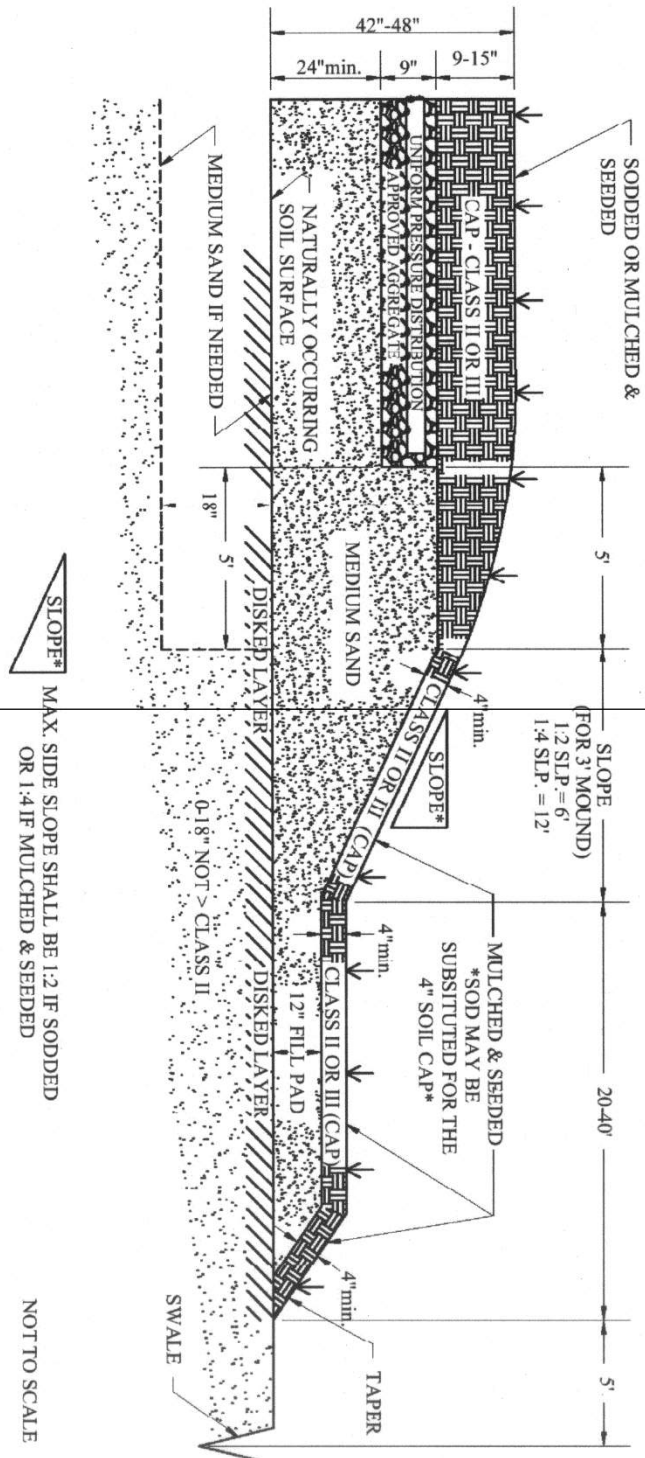

SOUTH CAROLINA DEPARTMENT OF HEALTH AND ENVIRONMENTAL CONTROL  
BUREAU OF ENVIRONMENTAL HEALTH SERVICES

ALTERNATIVE STANDARD  
MOUNDED FILL SYSTEMS  
PROGRAM 362 / CODE 431

TYPICAL DESIGN ILLUSTRATION A

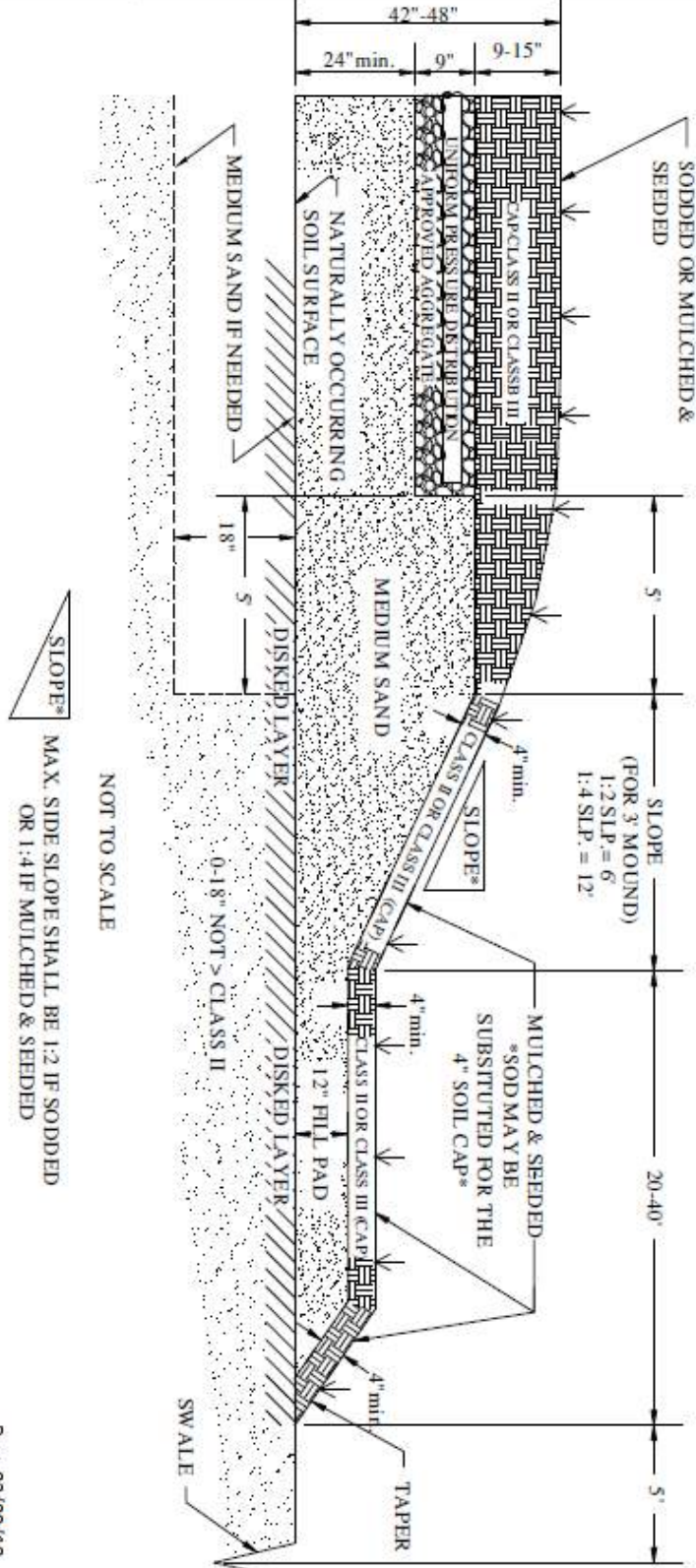

NOT TO SCALE

MAX. SIDE SLOPE SHALL BE 1:2 IF SODDED  
OR 1:4 IF MULCHED & SEEDED

Rev. 03/09/18

SOUTH CAROLINA DEPARTMENT OF HEALTH AND ENVIRONMENTAL CONTROL  
BUREAU OF ENVIRONMENTAL HEALTH SERVICES

ALTERNATIVE STANDARD  
MOUND FILL SYSTEMS  
PROGRAM 362 / CODE 431  
TYPICAL DESIGN ILLUSTRATION B

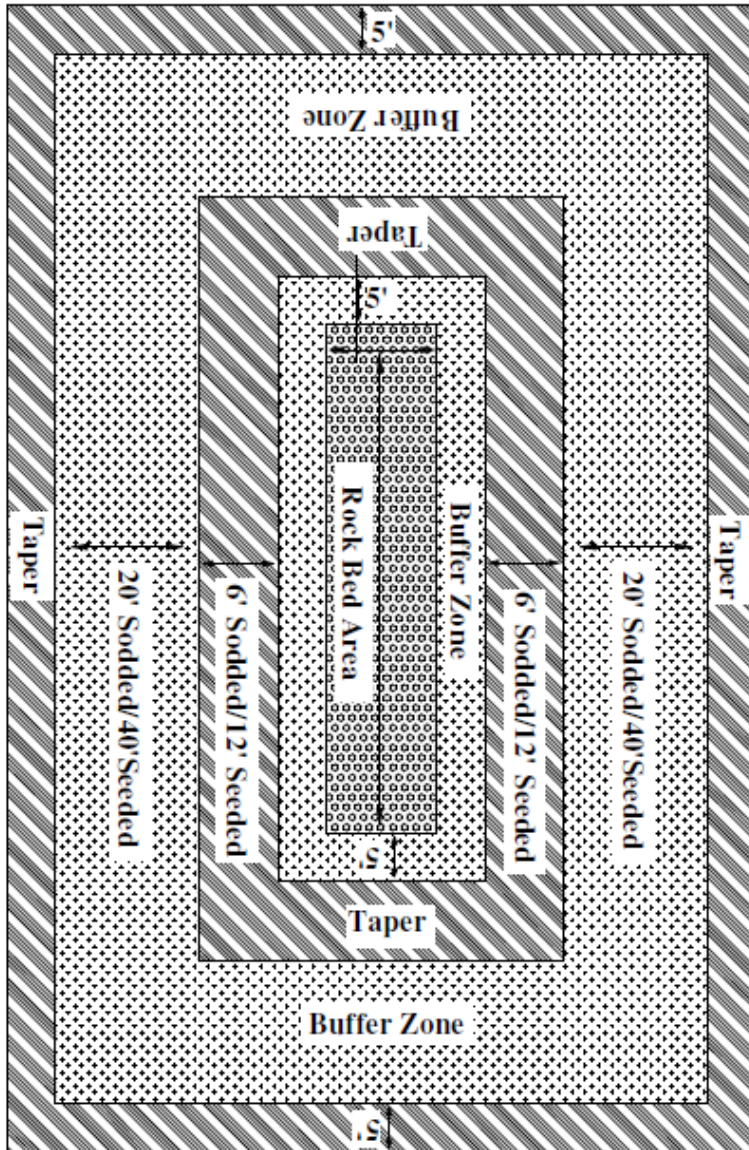

NOT TO SCALE

Rev. 03/09/18



SOUTH CAROLINA DEPARTMENT OF HEALTH AND ENVIRONMENTAL CONTROL  
BUREAU OF ENVIRONMENTAL HEALTH SERVICES

ALTERNATIVE STANDARD  
MOUND FILL SYSTEMS  
PROGRAM 962 / CODE 431  
TYPICAL DESIGN ILLUSTRATION C

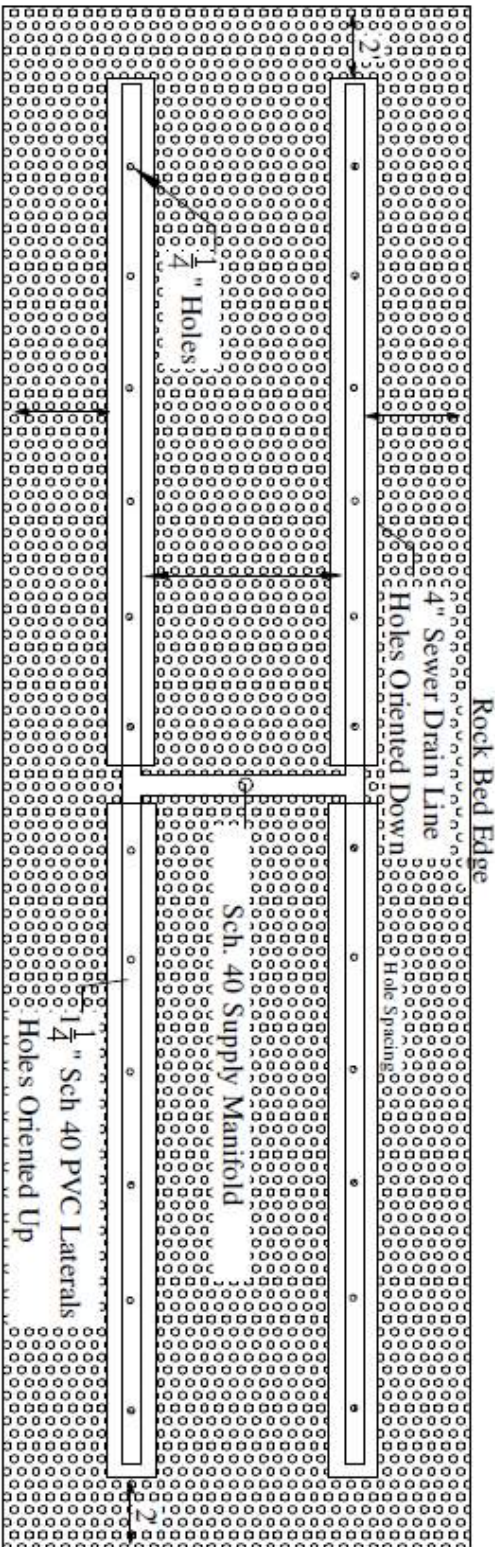

\*Note: Cleanouts are required at the end of each lateral to extend to finishing grade with screw-on cleanout caps.

NOT TO SCALE

Rev. 03/09/18

414 APPENDIX N SYSTEM STANDARD 601 ELEVATED INFILTRATION SYSTEM **Appendix P**  
**- System Standard 601 - Elevated Infiltration System**

~~414.1~~ SITE/PERMITTING REQUIREMENTS (1) Site/Permitting Requirements

~~(1)~~(a) The texture in the upper eighteen (18) inches of naturally occurring soil must be Class I or Class II.

~~(2)~~(b) The filter shall not be placed on slopes greater than three (3) percent.

~~(3)~~(c) This system cannot be considered for facilities with peak flow rates in excess of four hundred eighty (480) gallons per day gpd. ~~In addition, this~~ This system shall not be considered for facilities requiring grease traps.

~~(4)~~(d) There shall be a buffer of at least fifty (50) feet surrounding and separating the system from all adjacent property lines. This buffer shall be measured from the retaining wall.

~~(5)~~(e) There shall be a replacement area equivalent to at least fifty (50) percent in size of the original system area held in reserve for system repair. This area shall have a suitable configuration, and shall meet the minimum soil and site conditions of ~~R. 61-56~~ R.61-56.

~~(6)~~(f) This system shall not be placed on sites that flood.

~~(7)~~(g) No part of this system can be installed within one hundred twenty-five (125) feet of the critical area line or tidal waters as determined by the Department; or within one hundred twenty-five (125) feet of the ordinary high water elevation within the banks of non-tidal, environmentally sensitive waters.

~~(8)~~(h) Prior to permitting the onsite wastewater system, delineation of any affected jurisdictional wetlands may be required. Should any part of the proposed onsite wastewater system be located in jurisdictional wetlands, approval from the appropriate permitting agency(s) (i.e., e.g., US Army Corp. of Engineers, SCDHEC Ocean and Coastal Resource Management, etc.) shall be received, and proof of such provided to the Department. The absorption bed shall be sized on the most limiting soil texture class in the upper eighteen (18) inches of naturally occurring soil.

~~(9)~~(i) The total bottom area of the filter must be increased by fifty (50) percent above that required for conventional trenches.

~~(10)~~(j) This system may be considered for installation on contiguous lots in new subdivisions approved after the effective date of this standard provided a setback of at least seventy-five (75) feet is maintained between the system and all adjacent property lines. The seventy-five (75) foot setback shall be measured from the point at which the retaining wall intersects the naturally occurring soil surface.

~~414.2~~ INSTALLATION REQUIREMENTS (2) Installation Requirements

~~(1)~~(a) Site Preparation

~~(a)~~(i) If present within eighteen (18) inches of the naturally occurring soil surface, organic material and restrictive horizons must be removed from beneath the filter and replaced with USDA medium sand, washed concrete sand, or an equivalent material approved by the Department.

~~\_\_ (b)(ii)~~ The naturally occurring soil surface underlying the filter shall be thoroughly tilled and mixed with the imported filter material to a depth of six (6) inches.

~~\_\_ (2)(b)~~ System Requirements

~~\_\_ (a)(i)~~ The filter must be constructed to a height of at least thirty-six (36) inches above the original grade, with the sewage effluent passing through at least twenty-four (24) inches of filter material.

~~\_\_ (b)(ii)~~ The filter material shall be USDA medium sand, washed concrete sand, or other material approved by the Department.

~~\_\_ (e)(iii)~~ The filter retaining wall shall extend at least four (4) inches above the surface of the filter material and shall penetrate the naturally occurring soil surface at least four (4) inches.

~~\_\_ (d)(iv)~~ The filter retaining wall shall be constructed in accordance with the accompanying design illustrations.

~~\_\_ (e)(v)~~ Effluent discharged to this system must receive a higher degree of treatment than that provided by a conventional septic tank (~~f.e., e.g.~~, two compartment septic tank or two septic tanks in series).

~~\_\_ (f)(vi)~~ The top of the filter shall be capped with Class II or Class III soil, and shall slope from center to edges in order to promote surface runoff.

~~\_\_ (3)(c)~~ Distribution Requirements

~~\_\_ (a)(i)~~ Low Pressure Pipe Distribution (LPP) must be utilized to preclude localized hydraulic overloading of the imported fill material and to minimize the impact on the shallow zone of saturation.

(ii) Low Pressure Pipe Distribution (LPP) must be designed and installed in accordance with Department standards or equivalent designs. The size and layout of each distribution system will vary based on the size of the filter and the needed dosing.

~~\_\_ (b)(iii)~~ Pump design shall be in accordance with Department standards.

~~\_\_ 414.3 FINAL LANDSCAPING AND DRAINAGE REQUIREMENTS~~(3) Final Landscaping and Drainage

~~\_\_ (1)(a)~~ Fill material shall be placed around the outside of the filter to a depth of one (1) foot, and shall slope to original grade at a point five (5) feet from the retaining wall.

~~\_\_ (2)(b)~~ The septic tank and filter area shall be backfilled and shaped to promote the runoff of surface water.

~~\_\_ (3)(c)~~ Where natural surface drainage does not exist, a swale shall be constructed adjacent to the filter to divert surface water away from the onsite wastewater system to a positive outfall. The installation of ditches, curtain drains, and/or rain gutters may be required to intercept and divert water away from the onsite wastewater system location.

~~\_\_ (4)(d)~~ Following final landscaping, seeding or sodding may be required to prevent erosion.

(5)(e) Final approval shall be withheld until all landscaping and drainage improvements have been satisfactorily completed.



**SOUTH CAROLINA DEPARTMENT OF HEALTH AND ENVIRONMENTAL CONTROL  
BUREAU OF ENVIRONMENTAL HEALTH**

ALTERNATIVE SYSTEM  
ELEVATED INFILTRATION SYSTEM

PROGRAM 362 / CODE 601

TYPICAL DESIGN ILLUSTRATION

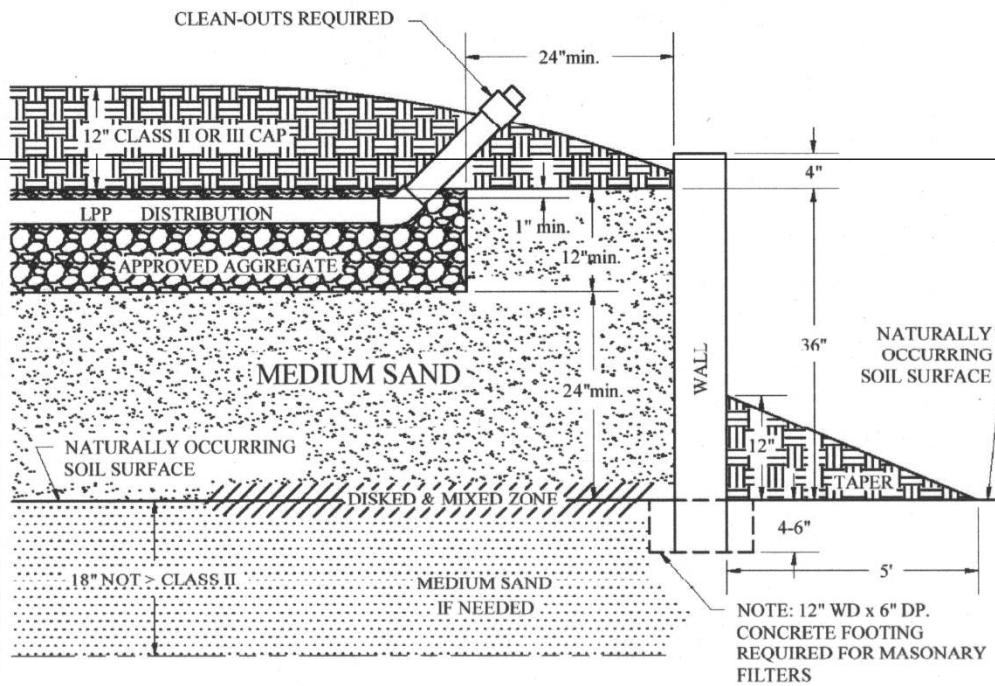

**SECTION A-A**

NOT TO SCALE

T15 REV. 03/16/97

**SOUTH CAROLINA DEPARTMENT OF HEALTH AND ENVIRONMENTAL CONTROL  
BUREAU OF ENVIRONMENTAL HEALTH**

ALTERNATIVE SYSTEM  
ELEVATED INFILTRATION SYSTEM

PROGRAM 362 / CODE 601

TYPICAL DESIGN ILLUSTRATION  
CIRCULAR STEEL FILTER DETAILS

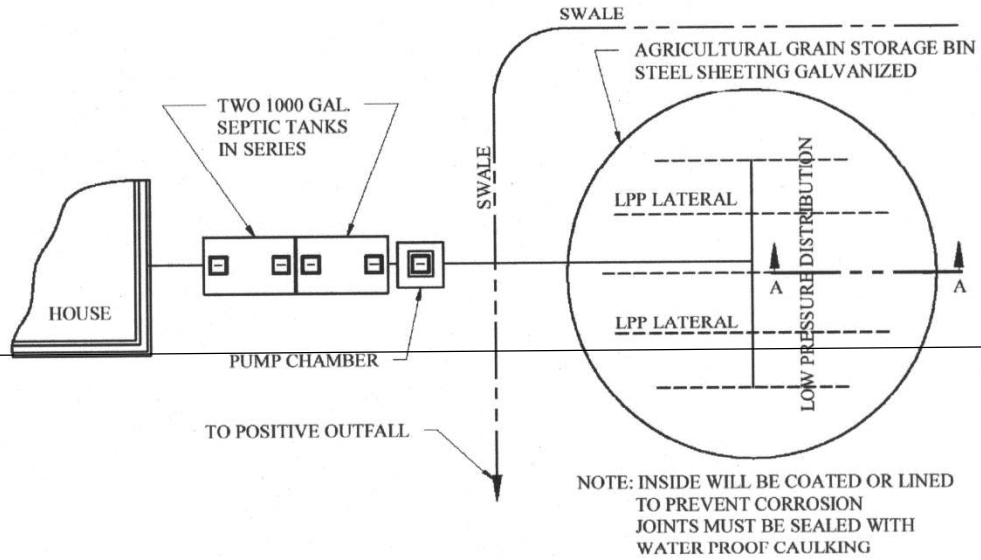

**PLAN VIEW**  
NOT TO SCALE

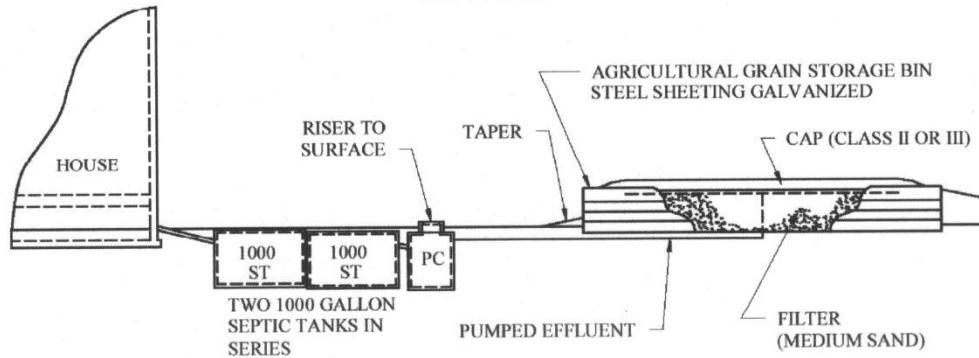

**ELEVATION**  
NOT TO SCALE

TLS REV. 05/14/97

**SOUTH CAROLINA DEPARTMENT OF HEALTH AND ENVIRONMENTAL CONTROL  
BUREAU OF ENVIRONMENTAL HEALTH**

ALTERNATIVE SYSTEM  
ELEVATED INFILTRATION SYSTEM

PROGRAM 362 / CODE 601

TYPICAL DESIGN ILLUSTRATION  
SQUARE CONCRETE & BLOCK FILTER DETAILS

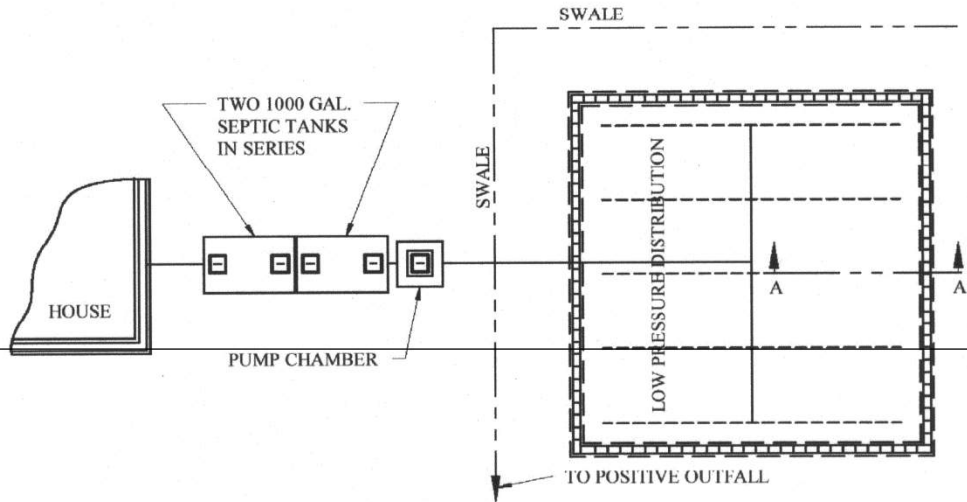

**PLAN VIEW**  
NOT TO SCALE

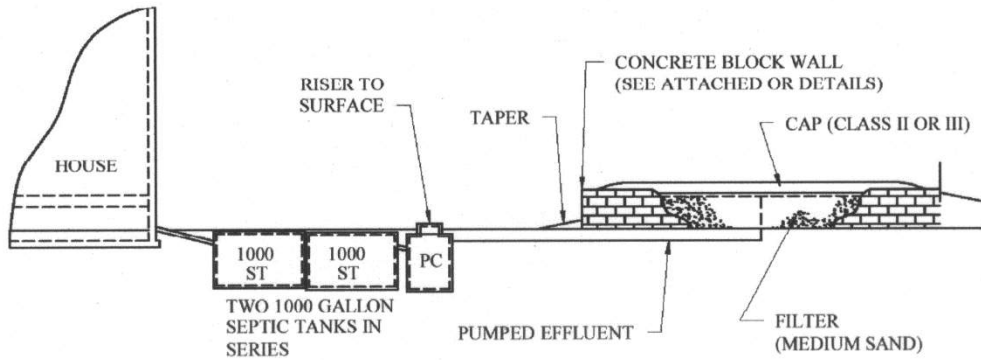

**ELEVATION**  
NOT TO SCALE

TLS REV. 03/16/07

**SOUTH CAROLINA DEPARTMENT OF HEALTH AND ENVIRONMENTAL CONTROL  
BUREAU OF ENVIRONMENTAL HEALTH**

ALTERNATIVE SYSTEM  
ELEVATED INFILTRATION SYSTEM

PROGRAM 362 / CODE 601

**TYPICAL DESIGN ILLUSTRATION**

SQUARE CONCRETE & BLOCK FILTER - WALL & FOUNDATION DETAIL

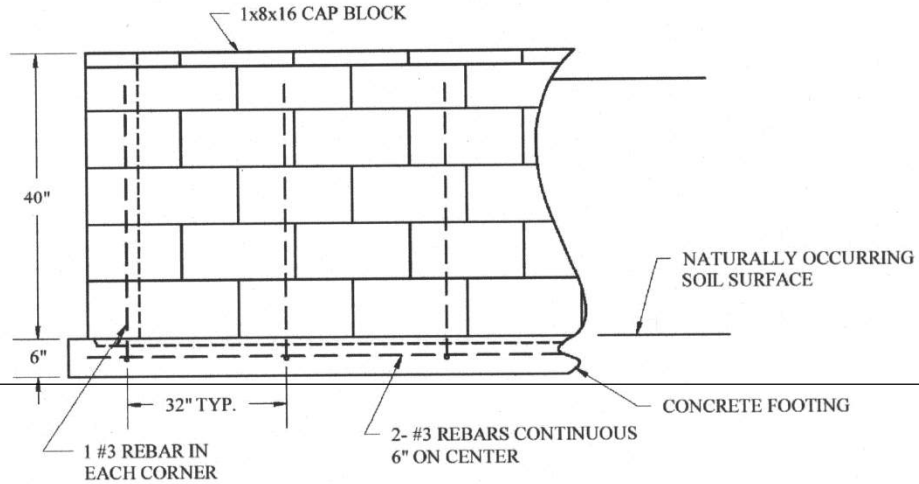

**WALL & FOUNDATION DETAIL**

NOT TO SCALE

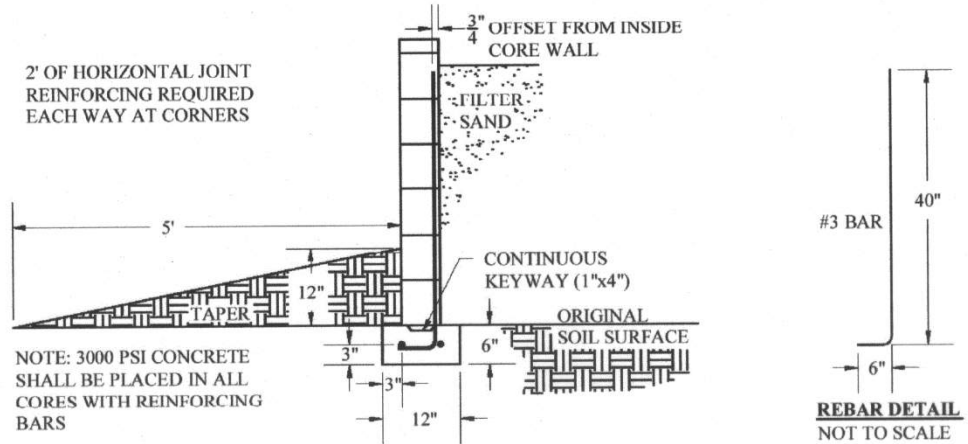

**WALL SECTION DETAIL**

NOT TO SCALE

NOTE: 14 DAY MINIMUM CURE TIME FOR WALL & FOUNDATION REQUIRED BEFORE INSTALLING FILTER SAND

115 REV. 03-16-07

**SOUTH CAROLINA DEPARTMENT OF HEALTH AND ENVIRONMENTAL CONTROL  
BUREAU OF ENVIRONMENTAL HEALTH SERVICES**

ALTERNATIVE STANDARD  
ELEVATED INFILTRATION SYSTEM

PROGRAM 362 / CODE 601

**TYPICAL DESIGN ILLUSTRATION - FIGURE A  
SQUARE CONCRETE & BLOCK FILTER DETAILS**

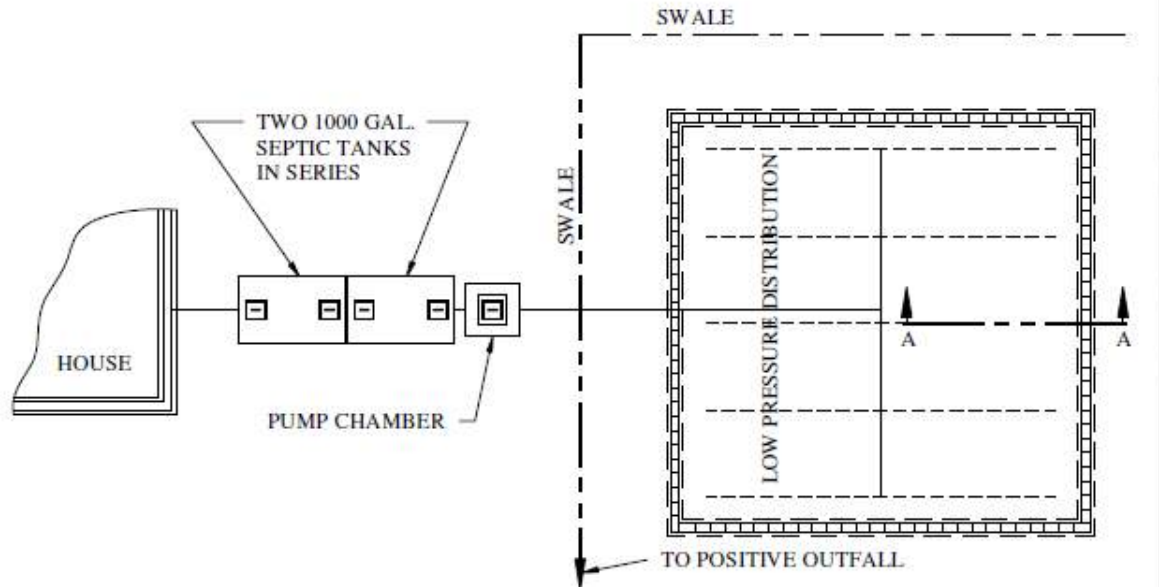

**PLAN VIEW**  
NOT TO SCALE

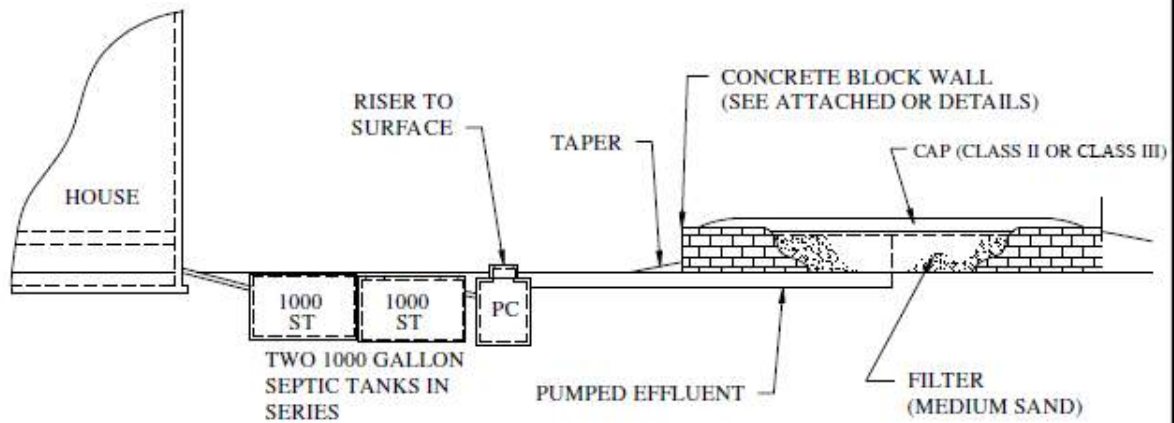

**ELEVATION**  
NOT TO SCALE

Rev. 03/09/18

**SOUTH CAROLINA DEPARTMENT OF HEALTH AND ENVIRONMENTAL CONTROL  
BUREAU OF ENVIRONMENTAL HEALTH SERVICES**

ALTERNATIVE STANDARD  
ELEVATED INFILTRATION SYSTEM

PROGRAM 362 / CODE 601

**TYPICAL DESIGN ILLUSTRATION - FIGURE A  
CIRCULAR STEEL FILTER DETAILS**

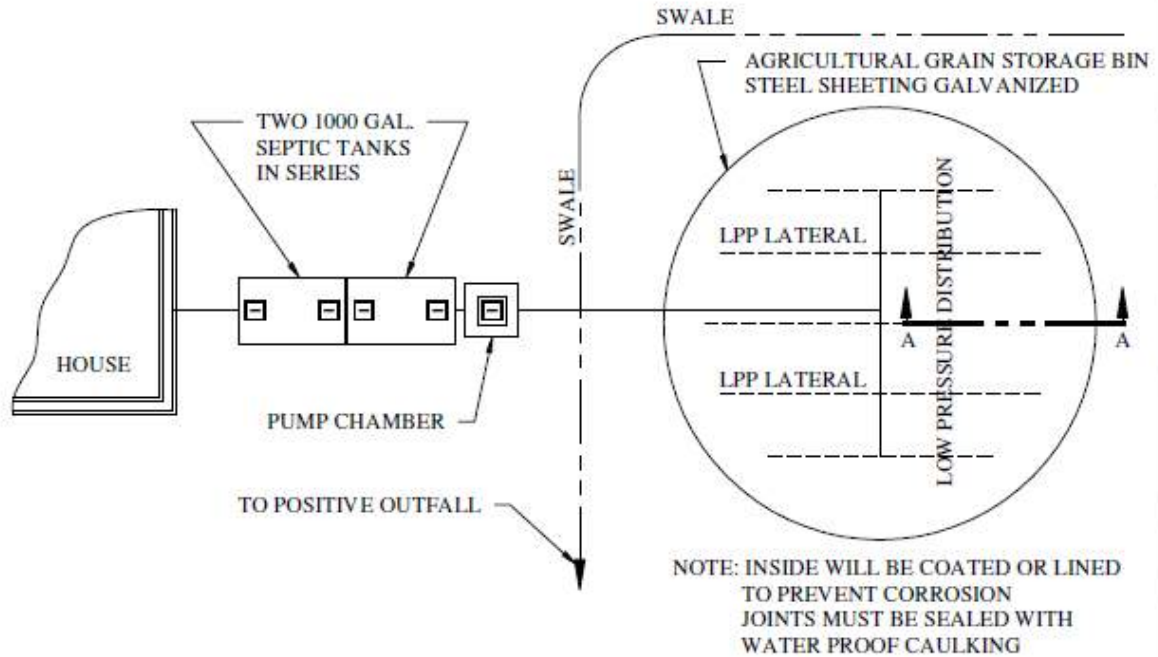

**PLAN VIEW  
NOT TO SCALE**

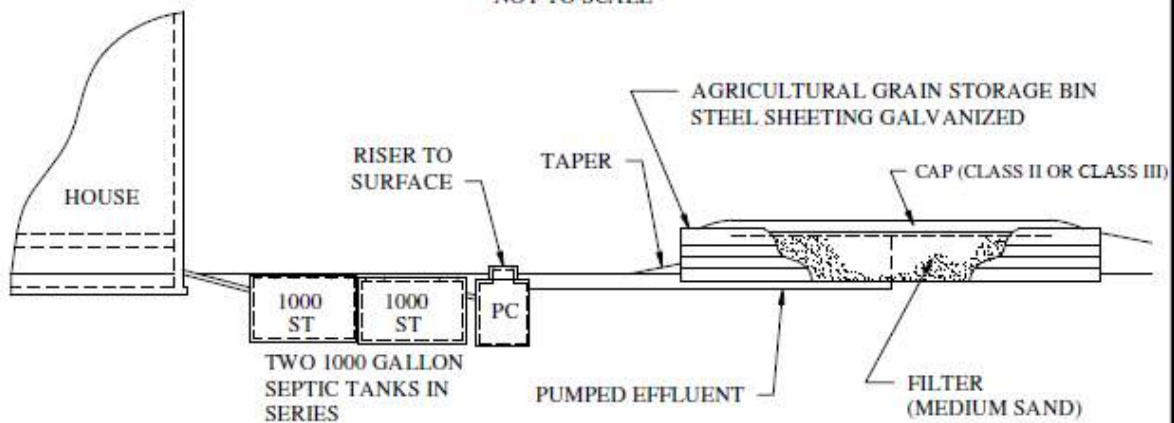

**ELEVATION  
NOT TO SCALE**

Rev. 03/09/18



**SOUTH CAROLINA DEPARTMENT OF HEALTH AND ENVIRONMENTAL CONTROL  
BUREAU OF ENVIRONMENTAL HEALTH SERVICES**

ALTERNATIVE STANDARD  
ELEVATED INFILTRATION SYSTEM

PROGRAM 362 / CODE 601

**TYPICAL DESIGN ILLUSTRATION - FIGURE B**  
**SQUARE CONCRETE & BLOCK FILTER DETAILS**

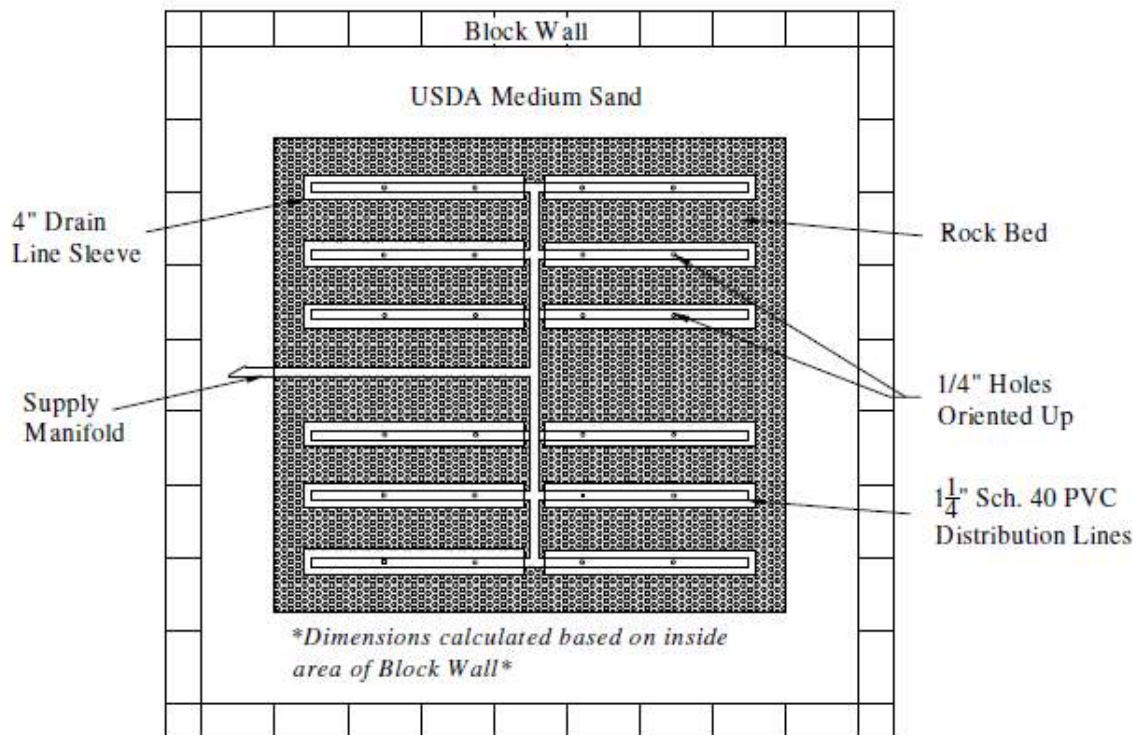

EACH LATERAL TO BE INSTALLED IN A ROCK BED

ALL LATERAL PRESSURE LINES ARE REQUIRED TO HAVE ELBOWS AT THE ENDS OF EACH LINE AND EXTEND TO FINISHING GRADE WITH SCREW-ON CLEANOUT CAPS

ALL HOLES ARE TO BE EQUALLY SPACED FROM ENDS OF EACH LINE AND BETWEEN EACH HOLE

**ELEVATION**  
NOT TO SCALE

Rev. 03/09/18

**SOUTH CAROLINA DEPARTMENT OF HEALTH AND ENVIRONMENTAL CONTROL  
BUREAU OF ENVIRONMENTAL HEALTH SERVICES**

ALTERNATIVE STANDARD  
ELEVATED INFILTRATION SYSTEM

PROGRAM 362 / CODE 601

**TYPICAL DESIGN ILLUSTRATION - FIGURE B  
CIRCULAR STEEL FILTER DETAILS**

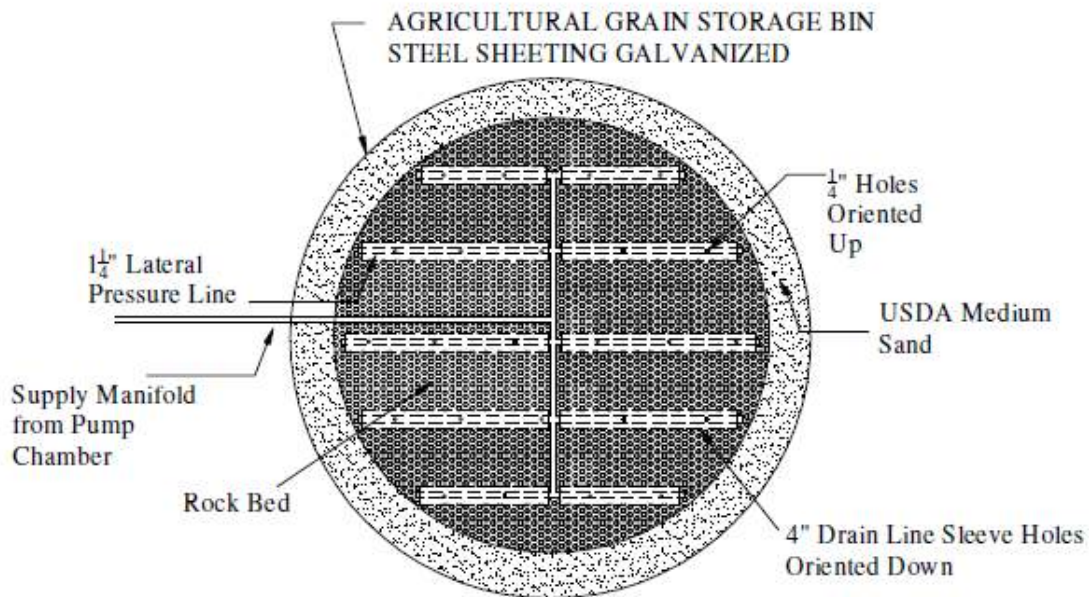

EACH LATERAL TO BE INSTALLED IN A ROCK BED

ALL LATERAL PRESSURE LINES ARE REQUIRED TO HAVE ELBOWS AT THE ENDS OF EACH LINE AND EXTEND TO FINISHING GRADE WITH SCREW-ON CLEANOUT CAPS

ALL HOLES ARE TO BE EQUALLY SPACED FROM ENDS OF EACH LINE AND BETWEEN EACH HOLE

**ELEVATION**  
NOT TO SCALE

Rev. 03/09/18



SOUTH CAROLINA DEPARTMENT OF HEALTH AND ENVIRONMENTAL CONTROL  
BUREAU OF ENVIRONMENTAL HEALTH SERVICES

ALTERNATIVE STANDARD  
ELEVATED INFILTRATION SYSTEM

PROGRAM 362 / CODE 601

TYPICAL DESIGN ILLUSTRATION -FIGURE C

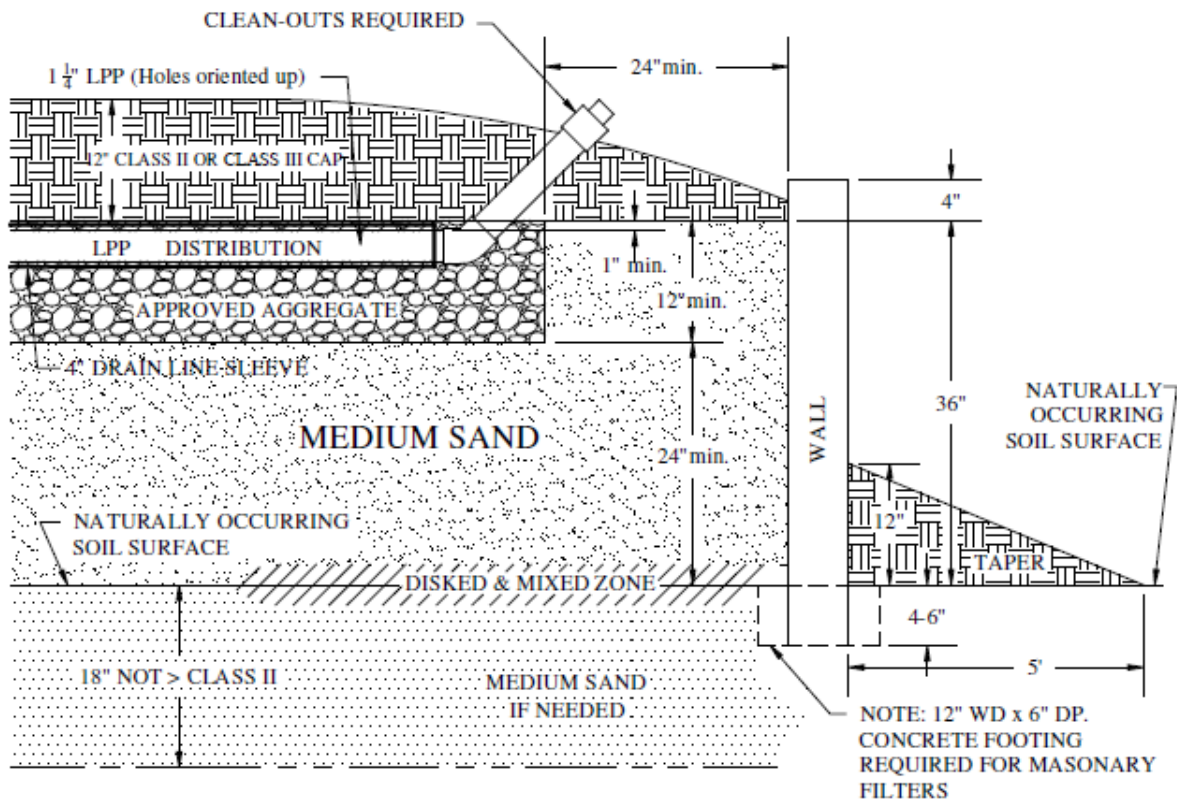

NOT TO SCALE

Rev. 03/09/18

415 APPENDIX Q - SYSTEM STANDARD 610 - SPECIALIZED ONSITE WASTEWATER SYSTEM  
DESIGNS (LESS THAN 1500 GPD) **Appendix Q - System Standard 610 - Specialized Onsite  
Wastewater System Designs (less than 1500 gpd)**

(1) Site/Permitting Requirements

~~(1)~~(a) This Standard shall not apply to the following:

~~(a)~~(i) Projects where two or more pieces of deeded property will share a common system.

~~(b)~~(ii) Residential or commercial projects where the individual or combined peak sewage flow is estimated to be in excess of fifteen hundred (1500) gpd.

~~(c)~~(iii) Projects that discharge wastes containing high amounts of fats, grease and oil, including restaurants and other food service facilities, unless the system manufacturer certifies that the proposed system is designed to treat such high strength wastes.

~~(d)~~(iv) Industrial process wastewater.

~~(2)~~(b) A site may be considered for a specialized onsite wastewater system design if written documentation provided by a Professional Engineer licensed in the State of South Carolina, including soil studies performed by a Professional Soil Classifier licensed in the State of South Carolina, indicates that the proposed system will function satisfactorily and in accordance with all requirements of R.61-56. Such substantiating documentation must include the following:

~~(a)~~(i) A Soils Report from a Professional Soil Classifier licensed in the State of South Carolina including detailed soil profile descriptions and Soil Series classification(s) utilizing methods and terminology specified in the Field Book for Describing and Sampling Soils; depth to the zone of saturation utilizing methods and terminology outlined in Redoximorphic Features for Identifying Aquic Conditions, and other appropriate principles specified in Soil Taxonomy; the depth to restrictive horizons; and a description of topography and other pertinent land features.

~~(b)~~(ii) Delineation of any affected jurisdictional wetlands, if applicable. Should any part of the proposed onsite wastewater system be located in jurisdictional wetlands, approval from the appropriate permitting agency(s) ~~(i.e., (e.g., US Army Corps of Engineers, SCDHEC Ocean and Coastal Resource Management))~~ shall accompany the application for a specialized onsite wastewater system design.

(iii) For drain field and replacement areas with a less than fifteen (15) inch zone of saturation, no part of a specialized onsite wastewater system may be installed within one hundred twenty-five (125) feet of the critical area line or tidal waters as determined by the Department; or within one hundred twenty-five (125) feet of the ordinary high water elevation within the banks of non-tidal, environmentally sensitive waters.

~~(c)~~(iv) There shall be a replacement area equivalent to at least fifty (50) percent in size of the original system area held in reserve for system repair. This area shall have a suitable configuration, and shall meet the minimum soil and site conditions of R.61-56.

~~(d)~~(v) A plan that has been sealed, signed and dated by a Professional Engineer licensed in the State of South Carolina certifying that the proposed onsite wastewater system has been designed in accordance with the requirements of R.61-56 and will function satisfactorily. The plan should also show an area equivalent to at least fifty (50) percent in size of the original system held in reserve for system repair.

~~\_\_~~~~(e)~~~~(vi)~~ The manufacturer's recommendations for operation and maintenance of the system, and the consulting engineer's management plan to meet this. For systems that have mechanical components and/or require a higher degree of maintenance to ensure the proper treatment and disposal of domestic wastewater, an Operation and Maintenance (O&M) plan must be developed by the designing engineer to be given to the party who is ultimately responsible for the operation of the system. O&M plans must be recorded along with the property deed and must run with the land.

~~\_\_~~~~(3)~~~~(c)~~ Any Permit ~~To~~ Construct that is issued pursuant to this standard shall be based upon the consulting engineer's design, certification, and other supporting documentation provided by the Professional Soil Classifier.

~~\_\_~~~~(4)~~~~(d)~~ The consulting engineer shall be responsible for supervising construction of the system and providing the Department with a certified "~~as-built~~" as-built plan of the actual installation containing all details required by the Department. The certified as-built plan must be submitted to the Department within two business days of completing the system installation. If the construction schedule for a specialized system installation is more than forty-eight (48) hours, the Department must be notified in advance of the beginning of construction. Any Final Approval that is released pursuant to this standard shall be based upon this engineering certification.

#### ~~416 APPENDIX P – Curtain Drain Standard~~ **Appendix R - Curtain Drain Standard**

##### ~~\_\_~~~~416.1~~ ~~Minimum Construction Requirements~~ (1) Minimum Construction Requirements

~~\_\_~~~~(1)~~~~(a)~~ Only pipe having received written approval from the Department may be utilized in curtain drains. This approval shall be based upon the pipe meeting all applicable ASTM standards.

~~\_\_~~~~(2)~~~~(b)~~ The aggregate used in curtain drains shall be a material approved by the Department ~~and shall range in size from one-half (1/2) inch to two and one-half (2 1/2) inches. Fines are prohibited.~~

~~\_\_~~~~(3)~~~~(c)~~ The curtain drain trench utilizing tire chips or gravel or a similar type of approved product shall be at least six (6) inches wide.

~~\_\_~~~~(4)~~~~(d)~~ The curtain drain shall be placed ten (10) feet upslope and twenty-five (25) feet down slope of a subsurface wastewater infiltration area or repair area. Where the aggregate portion of the curtain is installed at the same or lower (down slope) elevation relative to an adjacent subsurface wastewater infiltration area or repair area, the aggregate portion of the curtain must be a minimum of twenty-five (25) feet from the adjacent ~~the~~ subsurface wastewater infiltration area or repair area.

~~\_\_~~~~(5)~~~~(e)~~ The trench bottom shall have a uniform slope to the discharge point. ~~A minimum one (1) percent fall (12 inches per 100 feet) shall be utilized.~~ Trench excavation with a ditch witch is permissible provided the trench bottom has a uniform down slope gradient.

~~\_\_~~~~(6)~~~~(f)~~ The solid discharge (non-aggregate) line shall be fifteen (15) feet from adjacent subsurface wastewater infiltration area or repair area.

~~\_\_~~~~(7)~~~~(g)~~ The down slope side of the trench toward the subsurface wastewater infiltration area shall have a minimum six (6) mil poly or an equivalent ~~strong strength~~-treated impervious material draped from the trench surface to the trench bottom to prevent groundwater from bridging the curtain drain.

~~\_\_~~(8)(h) Agricultural drainpipe (slitted) with a minimum diameter of four (4) inches shall be placed along the trench bottom in the aggregate portion. Perforated pipe is acceptable, provided the perforations are installed facing either sideways or upward.

~~\_\_~~(9)(i) There shall be at least two (2) inches of aggregate beneath the drainpipe.

~~\_\_~~(10)(j) The aggregate shall be brought to at least six (6) inches from the ground surface.

~~\_\_~~(11)(k) The aggregate shall be covered with a strong, untreated pervious material to prevent infiltration of back fill material.

~~\_\_~~(12)(l) Solid drainpipe with a minimum diameter of four (4) inches shall be placed along the trench bottom from the aggregate to the discharge point.

~~\_\_~~(13)(m) The curtain drain must discharge to the ground surface past the last wastewater infiltration trench line.

~~\_\_~~(14)(n) Rodent barriers on discharge pipe outlet(s) are required.

~~\_\_~~(15)(o) If the curtain drain's trench bottom depth exceeds thirty (30) inches, it shall be inspected prior to the aggregate being installed to insure proper trench depth and grade. It is acceptable to place the pipe and aggregate in the trench prior to the final inspection when a probe rod inspection port can be used to accurately measure trench bottom depth.

**SOUTH CAROLINA DEPARTMENT OF HEALTH AND ENVIRONMENTAL CONTROL  
BUREAU OF ENVIRONMENTAL HEALTH**

**CURTAIN DRAIN STANDARD  
TYPICAL DESIGN SKETCH**

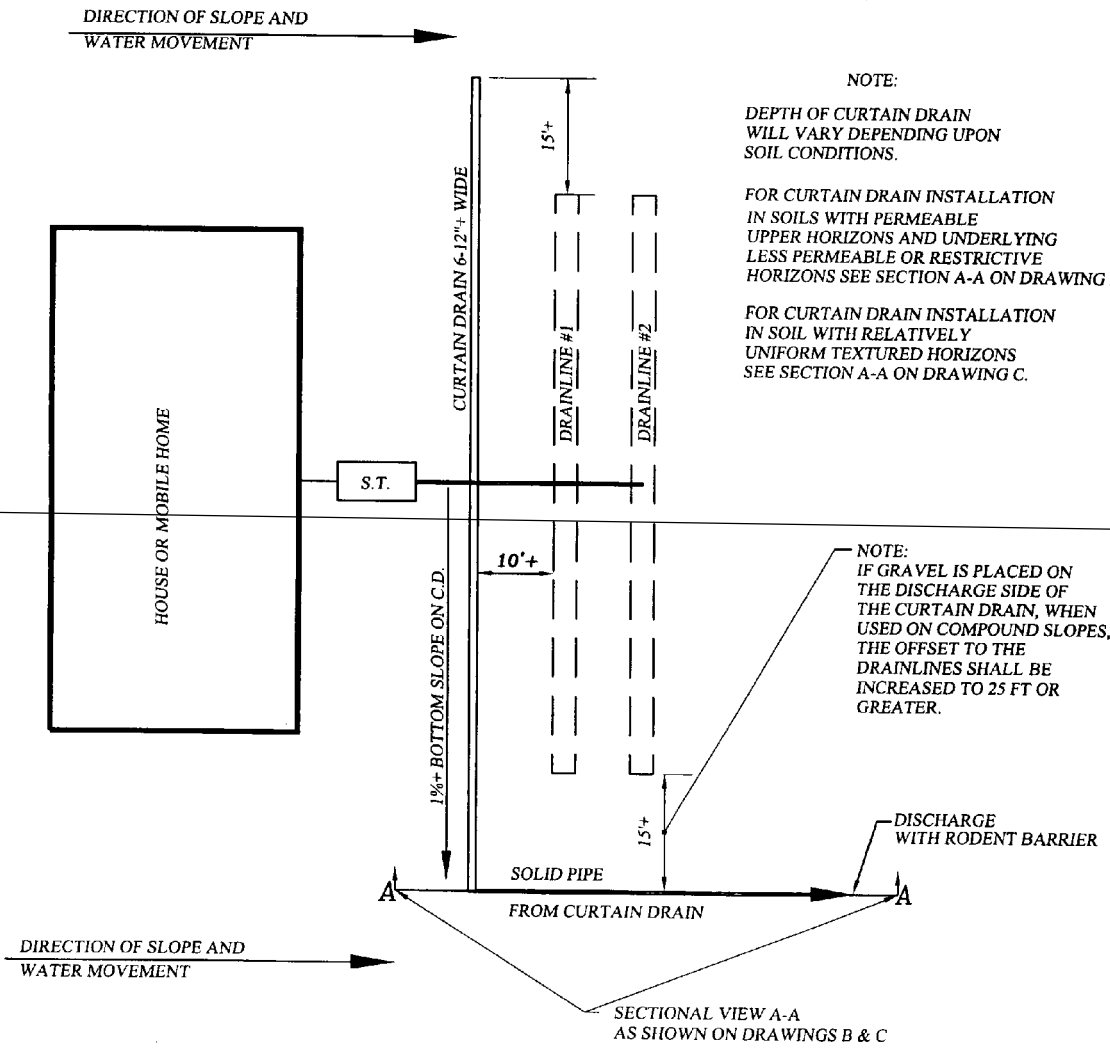

NOTE:  
DEPTH OF CURTAIN DRAIN  
WILL VARY DEPENDING UPON  
SOIL CONDITIONS.

FOR CURTAIN DRAIN INSTALLATION  
IN SOILS WITH PERMEABLE  
UPPER HORIZONS AND UNDERLYING  
LESS PERMEABLE OR RESTRICTIVE  
HORIZONS SEE SECTION A-A ON DRAWING B.

FOR CURTAIN DRAIN INSTALLATION  
IN SOIL WITH RELATIVELY  
UNIFORM TEXTURED HORIZONS  
SEE SECTION A-A ON DRAWING C.

NOTE:  
IF GRAVEL IS PLACED ON  
THE DISCHARGE SIDE OF  
THE CURTAIN DRAIN, WHEN  
USED ON COMPOUND SLOPES,  
THE OFFSET TO THE  
DRAINLINES SHALL BE  
INCREASED TO 25 FT OR  
GREATER.

**DRAWING A**

T.L.S.

**SOUTH CAROLINA DEPARTMENT OF HEALTH AND ENVIRONMENTAL CONTROL  
BUREAU OF ENVIRONMENTAL HEALTH**

**CURTAIN DRAIN STANDARDS**

CURTAIN DRAIN INSTALLATION IN SOILS WITH RESTRICTIVE OR LESS PERMEABLE HORIZONS BELOW THE DRAINFIELD  
TYPICAL DESIGN SKETCH

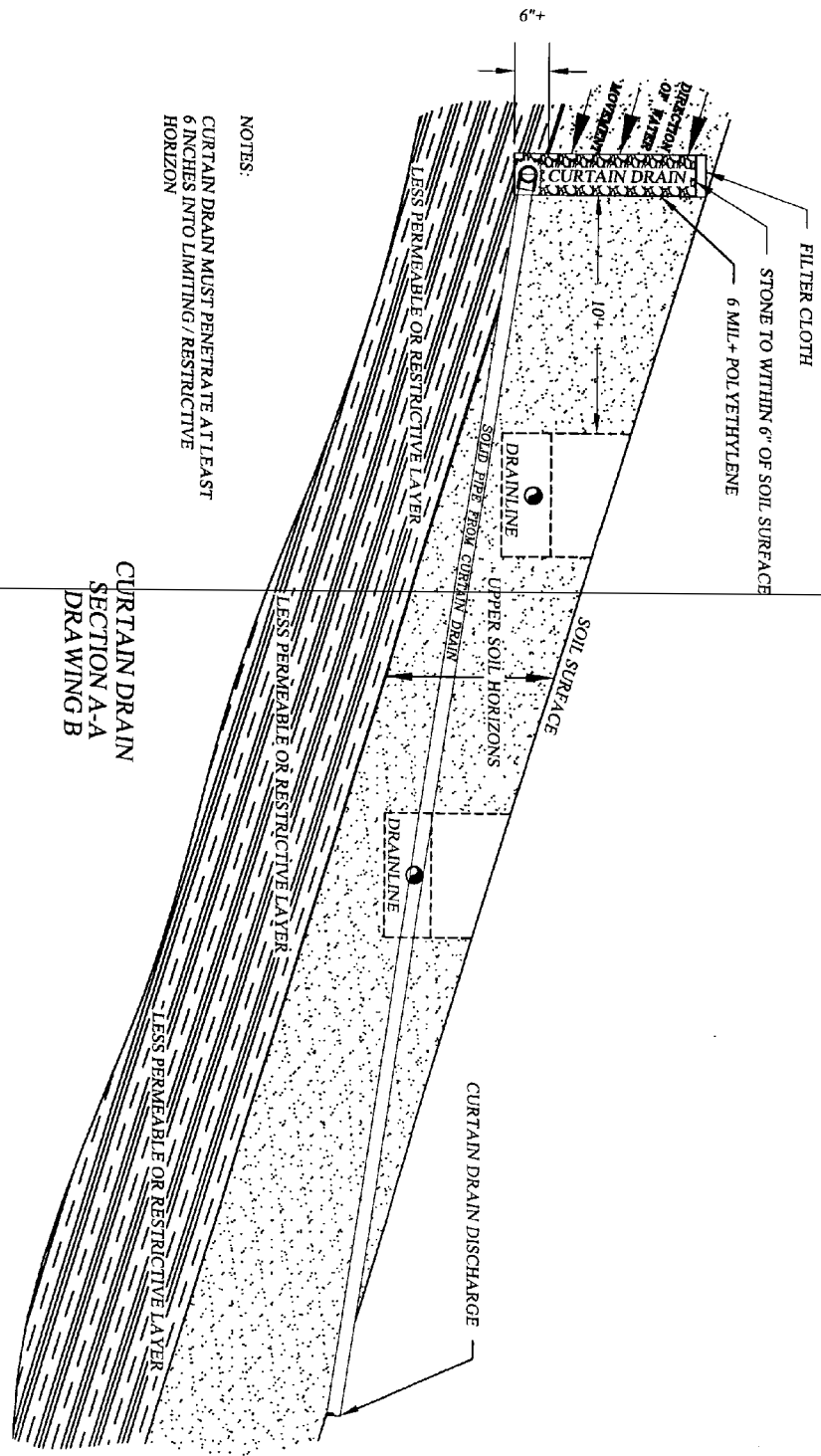

NOTES:  
CURTAIN DRAIN MUST PENETRATE AT LEAST  
6 INCHES INTO LIMITING / RESTRICTIVE  
HORIZON

CURTAIN DRAIN  
SECTION A-A  
DRAWING B

DRAWING NOT TO SCALE

T.L.S.

**SOUTH CAROLINA DEPARTMENT OF HEALTH AND ENVIRONMENTAL CONTROL  
BUREAU OF ENVIRONMENTAL HEALTH**

**CURTAIN DRAIN STANDARDS**

**CURTAIN DRAIN INSTALLATION IN SOILS WITH RELATIVELY UNIFORM HORIZONS  
TYPICAL DESIGN SKETCH**

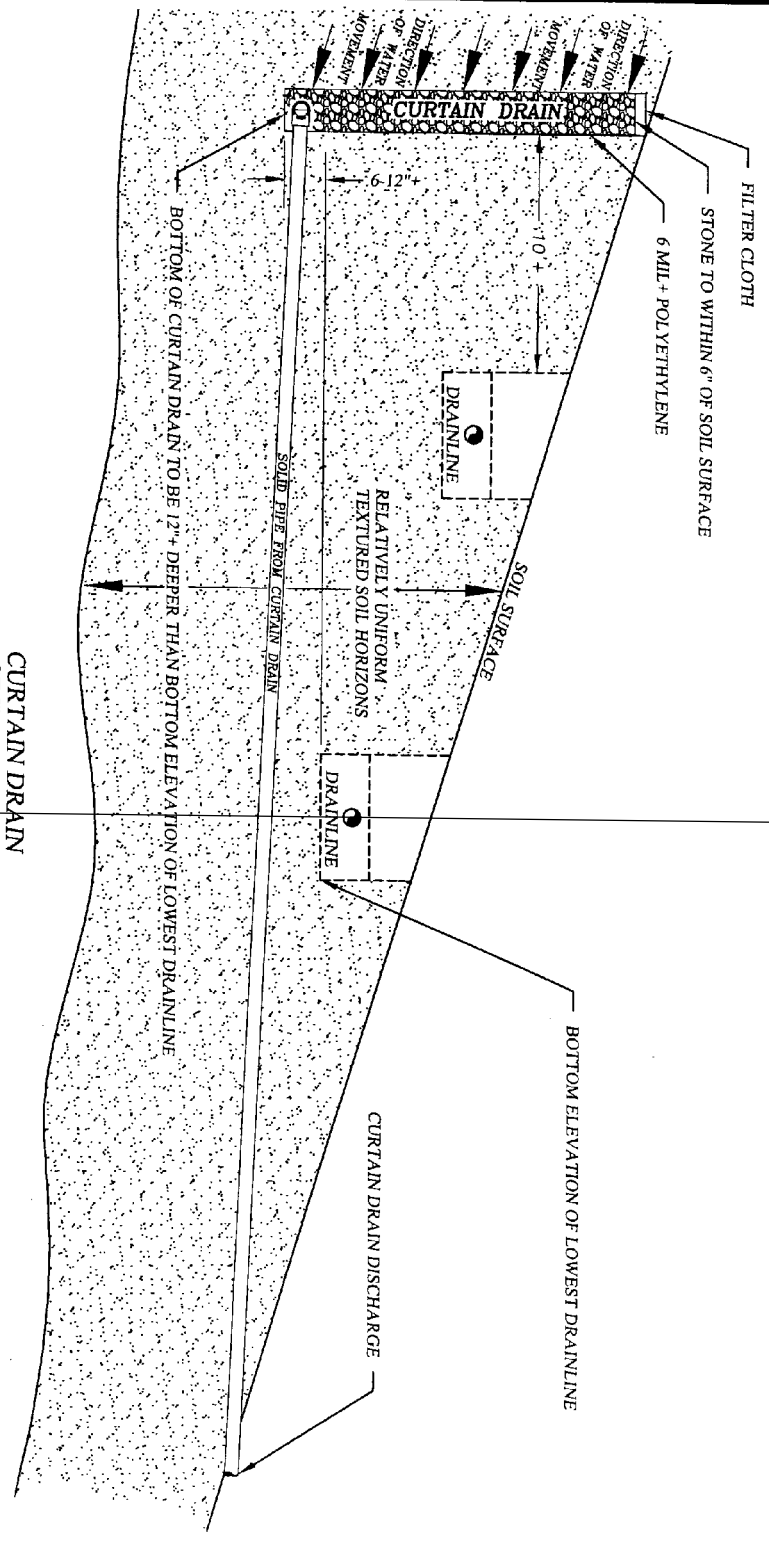

**CURTAIN DRAIN  
SECTION A-A  
DRAWING C**

DRAWING NOT TO SCALE

T.L.S.

**SOUTH CAROLINA DEPARTMENT OF HEALTH AND ENVIRONMENTAL CONTROL  
BUREAU OF ENVIRONMENTAL HEALTH SERVICES**

**CURTAIN DRAIN STANDARD**

**TYPICAL DESIGN SKETCH**

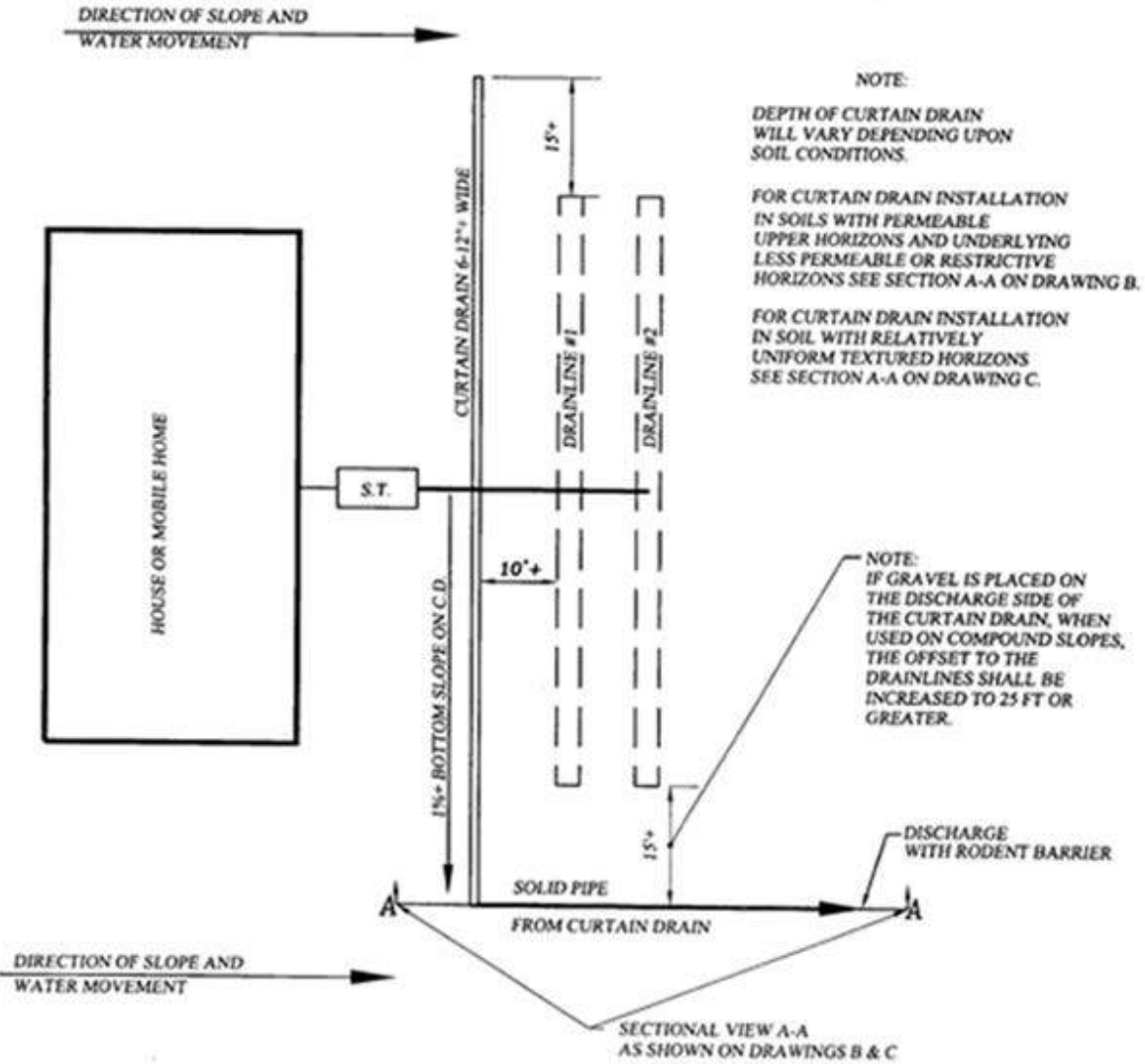

**DRAWING A**

Rev. 03/09/18



**SOUTH CAROLINA DEPARTMENT OF HEALTH AND ENVIRONMENTAL CONTROL  
BUREAU OF ENVIRONMENTAL HEALTH SERVICES**

**CURTAIN DRAIN STANDARDS**

CURTAIN DRAIN INSTALLATION IN SOILS WITH RESTRICTIVE OR LESS PERMEABLE HORIZONS BELOW THE DRAINFIELD  
**TYPICAL DESIGN SKETCH**

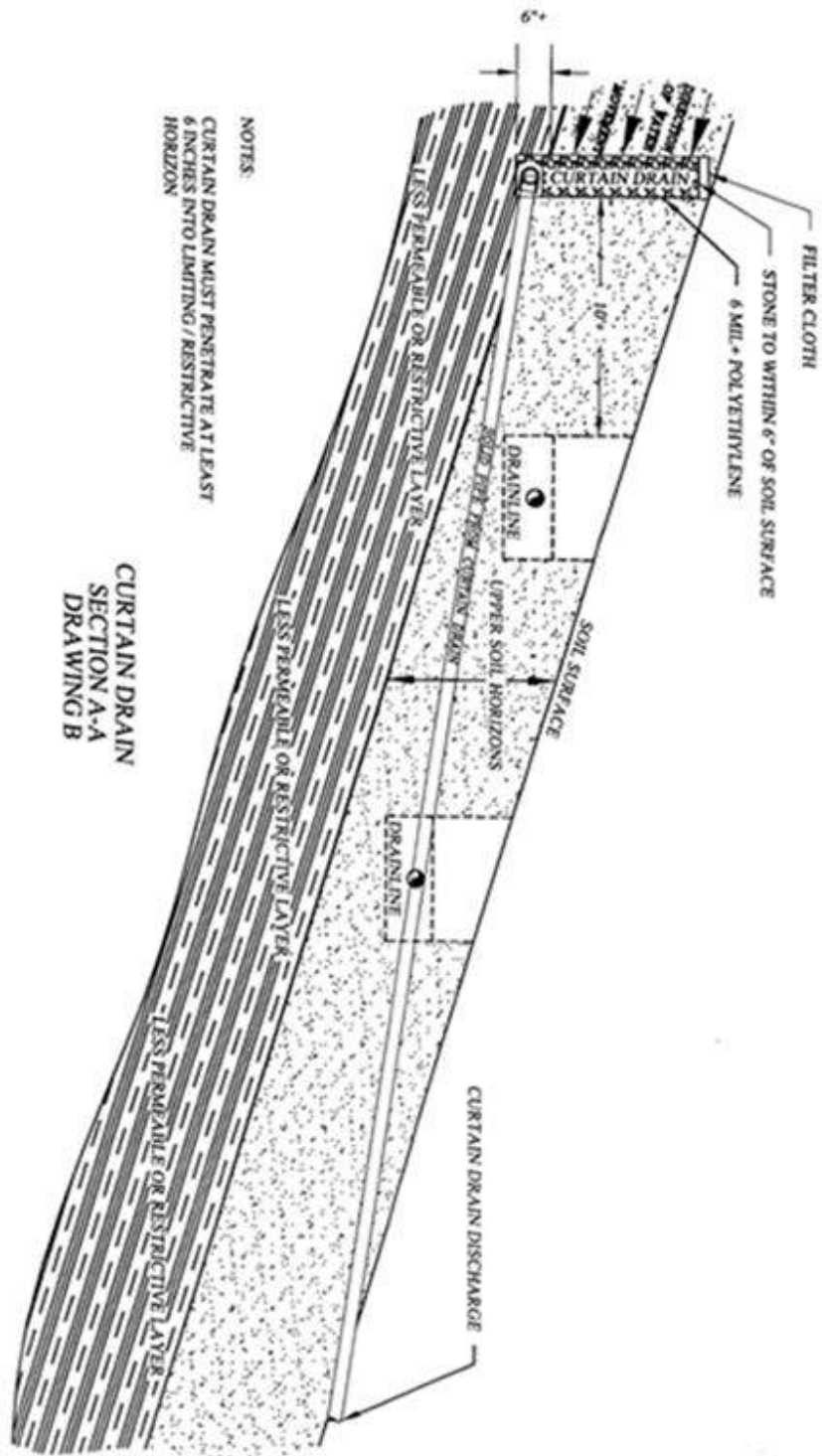

**NOTES:**  
CURTAIN DRAIN MUST PENETRATE AT LEAST  
6 INCHES INTO LIMITING / RESTRICTIVE  
HORIZON

**CURTAIN DRAIN  
SECTION A-A  
DRAWING B**

DRAWING NOT TO SCALE

Rev. 03/09/18

**SOUTH CAROLINA DEPARTMENT OF HEALTH AND ENVIRONMENTAL CONTROL  
BUREAU OF ENVIRONMENTAL HEALTH SERVICES**

**CURTAIN DRAIN STANDARDS**

CURTAIN DRAIN INSTALLATION IN SOILS WITH RELATIVELY UNIFORM HORIZONS  
TYPICAL DESIGN SKETCH

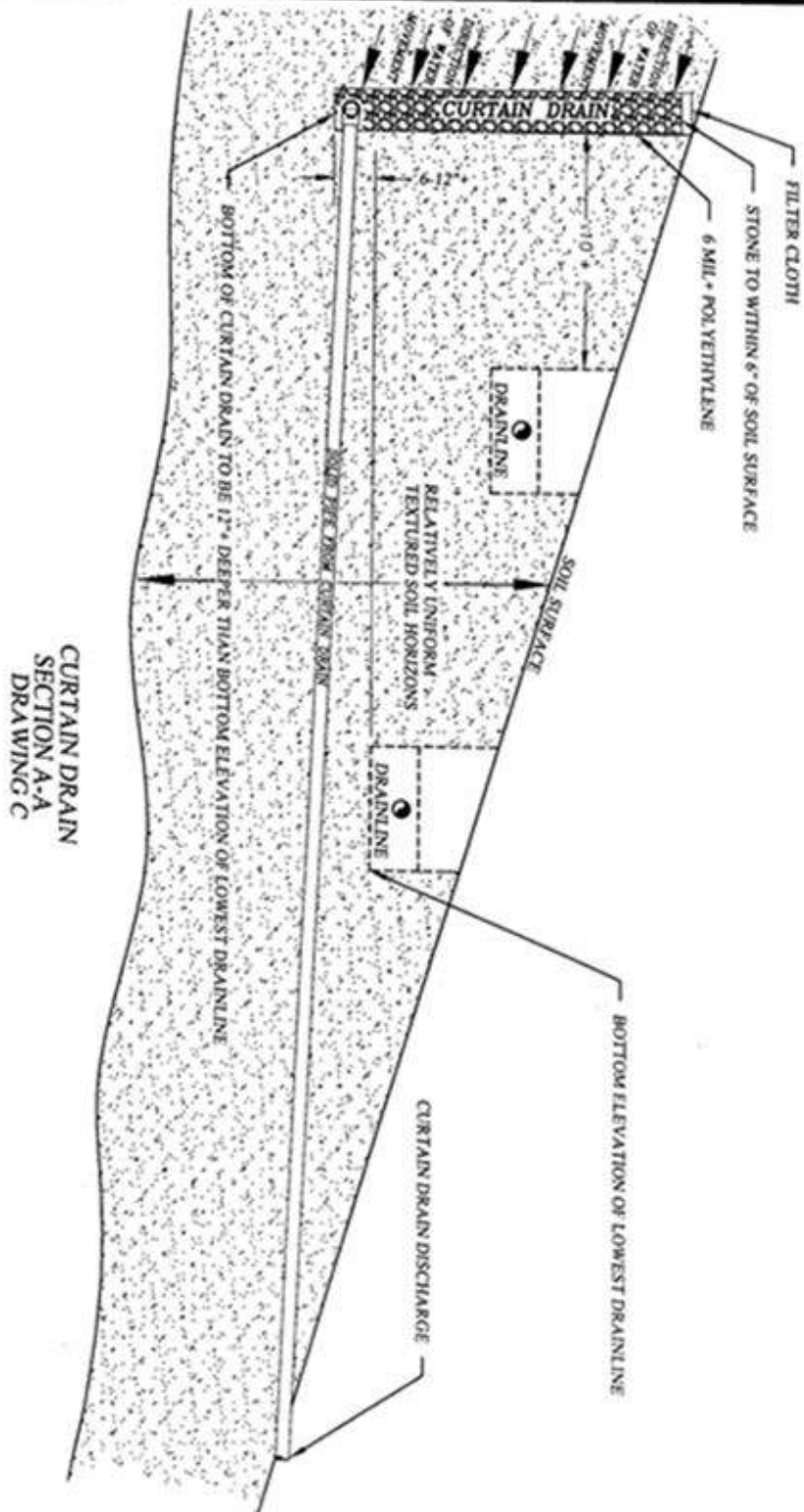

DRAWING NOT TO SCALE

Rev. 03/09/18

## **Appendix S - Nonwater-Carried Sewage Treatment Systems**

(1) The permitting of nonwater-carried sewage treatment systems, such as a biological, composting, or incinerating toilet, may be considered for toilet wastes when a proposed site is unsuitable for the issuance of an onsite wastewater system permit under the system standards in Appendices A through R. Nonwater-carried sewage treatment systems shall be designed, installed, maintained, and operated without endangering public health, the environment, or creating a nuisance.

(2) All applicants seeking to install a nonwater-carried sewage treatment system must submit to the Department plans from a Professional Engineer licensed in South Carolina which describe the design and installation of the proposed nonwater-carried sewage treatment system and demonstrate the following:

(a) The system complies with all local codes and ordinances.

(b) All products and processes meet applicable National Sanitation Foundation (NSF) Standards and American National Standards Institute (ANSI) Standard 41 and bear the seal of approval of the NSF or an equivalent testing and certification program.

(c) Compartment and appurtenances are insect and vector-proof and have continuous exterior ventilation.

(d) There will be no liquid wastewater produced by the system.

(e) Methods for training the owner/operator in the proper use, function, and maintenance of the system including safe handling and disposal methods for any residue generated by the system.

(f) All manufacturer recommendations for installation, operation, and maintenance will be followed.

(g) Applications for this process shall be considered under Level 1 in section 102.1.

(3) Applicants seeking to install a nonwater-carried sewage treatment system at a site where water under pressure will be connected to the structure and gray water is generated (from showers, sinks, etc.), but where nonwater-carried sewage treatment systems will be the only means for toilet waste disposal, must:

(a) Submit plans from a Professional Engineer licensed in South Carolina which meet the requirements of Appendix S, paragraphs (2)(a) through (f), for all toilet wastes; and

(b) Apply for and obtain a Department Permit to Construct and Approval to Operate an onsite wastewater system for treatment of gray water. This system must meet all permit, licensing, and OSWW system requirements under this regulation, except that the initial system size may be reduced by twenty-five (25) percent.

(4) A licensed installer is not required for the installation of a nonwater-carried sewage treatment system under this Standard. However, engineering certifications using the applicable Department form must be submitted to the Department before the Department will issue an Approval to Operate a system under this Standard.

## **Appendix T - Wastewater Combustion Systems**

(1) Wastewater combustion systems may be considered when a proposed site is unsuitable for the issuance of an onsite wastewater system permit under the system standards in Appendices A through R. A

wastewater combustion system shall be designed, installed, maintained, and operated without endangering public health, the environment, or creating a nuisance.

(2) All applicants seeking to install a wastewater combustion system must submit to the Department plans from a Professional Engineer licensed in South Carolina which describe the design and installation of the proposed wastewater combustion system and demonstrate the following:

(a) The system complies with all local codes and ordinances.

(b) Canadian Standards Association (CSA) certification of the wastewater combustion system in the United States.

(c) The system must be of adequate size to handle the wastewater volume and peak flow generated by the structure.

(d) Compartment and appurtenances are insect and vector-proof and have continuous exterior ventilation.

(e) All liquid wastewater produced must be sent to the combustion system. Liquid wastewater must not be sent to an onsite wastewater system or held in a storage system to be pumped and hauled.

(f) Methods for training the owner/operator in the proper use, function, and maintenance of the system including safe handling and disposal methods for any residue generated by the system.

(g) All manufacturer recommendations for installation, operation, and maintenance will be followed.

(h) Applications for this process shall be considered under Level 1 in section 102.1.

(3) Applicants seeking to install a wastewater combustion system for toilet wastes in conjunction with a gray water system for other household wastewater must:

(a) Submit to the Department plans from a Professional Engineer licensed in South Carolina which meet the requirements of Appendix T, paragraphs (2)(a) through (g), for all toilet wastes; and

(b) Apply for and obtain a Department Permit to Construct and Approval to Operate an onsite wastewater system for treatment of gray water. This system must meet all permit, licensing, and OSWW system requirements under this regulation, except that the initial system size may be reduced by twenty five (25) percent.

(4) A licensed installer is not required for the installation of a wastewater combustion system under this Standard. However, engineering certifications using the applicable Department form must be submitted to the Department before the Department will issue an approval to operate a system under this Standard.

~~500 APPENDIX Q — LONG TERM ACCEPTANCE RATE STANDARD FOR ONSITE WASTEWATER SYSTEMS~~  
**500 Long Term Acceptance Rate Standard for Onsite Wastewater Systems**

<b>USDA-NRCS SOIL TEXTURE</b>	<b>SOIL CHARACTERISTICS WHEN MOIST (FIELD TEST)</b>	<b>LONG-TERM LONG TERM ACCEPTANCE RATE (GPD/SF)</b>	
Sand (S)	Sandy Sand has a gritty feel, does not stain the fingers, and does not form ribbon or ball when wet or moist.	0.9 – 1.0	Class I
Loamy Sand (LS)	Loamy sand has a gritty feel, stains the fingers, forms a weak ball, and cannot be handled without breaking.		
Sandy Loam (SL)	Sandy loam has a gritty feel and forms a ball that can be picked up with the fingers and handled with care without breaking.	0.7 – 0.8	Class II
Loam (L)	Loam may have a slightly gritty feel but does not show a fingerprint, and forms only short ribbons of from 0.25 – 0.50 inch. Loam will form a ball that can be handled without breaking.		
Sandy Clay Loam (SCL)	Sandy clay loam has a gritty feel but contains enough clay to form a firm ball, and may ribbon from 0.75 – 1.0 inch.	0.5 – 0.6	Class III
Clay Loam (CL)	Clay loam is sticky when moist, forms a ribbon of 1.0 – 2.0 inches, and produces a slight sheen when rubbed with the thumbnail. Clay loam produces a nondistinct fingerprint.		
Silt Loam (SiL)	Silt loam has a floury feel when moist and will show a fingerprint, but will not ribbon and forms only a weak ball.		
Silt (Si)	Silt has a floury feel when moist and is sticky when wet but will not ribbon and forms a ball that will tolerate some handling.	0.1 – 0.4	Class IV
Silty Clay Loam (SiCL)	Silty clay loam has a slight floury feel, is sticky when moist, and will ribbon from 1.0 – 2.0 inches. Rubbing with thumbnail produces a moderate sheen. Silty clay loam produces a distinct fingerprint.		
Sandy Clay (SC)	Sandy clay is plastic, gritty, and sticky when moist, forms a firm ball, and produces a ribbon in excess of 2.0 inches.		
Clay (C)	Clay is both sticky and plastic when moist, produces a ribbon in excess of 2.0 inches, produces a high sheen when rubbed with the thumbnail, and forms a strong ball resistant to breaking.		
Silty Clay (SiC)	Silty clay has a slight floury feel, is both sticky and plastic when moist, forms a ball, and produces a ribbon in excess of 2.0 inches.		

(1) The long-term acceptance rate for system sizing shall be based upon the most hydraulically limiting naturally occurring soil texture from the ground surface to twelve (12) inches below the bottom of the proposed wastewater infiltration trenches. Alternative and experimental systems installed beneath expansive soils shall be sized at a long-term acceptance rate not to exceed 0.2-0.25 GPD/SF ~~gpd/sf~~ as specified in approved standards.

(2) Soil texture shall be estimated by field testing as described above. Laboratory determination of soil texture may be substituted for field testing when conducted in accordance with: (1) Bouyoucos, G.J. 1962. Hydrometer Method Improved for Making Particle Size Analyses of Soils. Agron. J. 53:464-465; (2) ASTM D-422, Procedures for Sieve and Hydrometer Analyses; or (3) the Pipette Method (ASA-CSSA-SSSA),

USDA Methods of Soils Analysis, Soil Survey Laboratory Information Manual, and Soil Survey Laboratory Methods Manual.

(3) The total linear feet (LF<sub>lf</sub>) for conventional onsite wastewater systems shall be calculated by dividing the peak daily flow (GPD<sub>gpd</sub>) by the long-term acceptance rate (GPD/SF<sub>gpd/sf</sub>) and dividing the result by the trench width (FT<sub>ft</sub>):  $LF_{lf} = \frac{GPD_{gpd}}{GPD/SF_{gpd/sf} \times FT_{ft}}$ . The total linear feet for alternative systems may either be increased or decreased in accordance with factors specified in alternative standards.

~~501 APPENDIX R – PEAK SEWAGE FLOW RATE STANDARD~~ **501 Peak Sewage Flow Rate Standard**

ESTABLISHMENT	UNIT	PEAK FLOW RATE GAL/UNIT/DAY
Airport (Not Including Food Service)	Passenger	3
Assembly Halls	Person	3
Bar (Not Including Food Service)	Customer Seat	5 15
Beauty/Style Shops/Barber Shops	Chair	100
Businesses/Offices/Factories	Employee/Shift	15
	Transient Employee (4 hrs or Less/Shift)	10
(Add for Showers)	Employee	10
Camps (No Laundry)		
-Labor/Summer/Retreat	Person	35
(Separate Food Service)	Person	10
(Separate Bath House)	Person	25
-Day Camps (with meal)	Person	15
(without meal)	Person	10
Campgrounds (No Laundry)		
-Full Water/Sewer	Campsite	120
-No Sewer Risers, Bathhouse only	Campsite	50
(Add for Dump Station)	Campsite	40
Car Wash (Non-automatic)	Bay	500
Church (No Daycare)		
-With Kitchen	Seat	3
-Without Kitchen	Seat	2
-Family Life Center	Person	5
Day Care	Child	10
Food Service		
-Full Service Utensils	Meal	4
	Person	10
	Seat	40
-Paper/Plastic Utensils		Reduce by 50 percent
Golf Course Club House (Not Including Foodservice)	Player	10
Kennel	Run	25

ESTABLISHMENT	UNIT	PEAK FLOW RATE GAL/UNIT/DAY
Laundromat	Machine	500
Mortuary	Body	25
Hotel/Motel (Not Including Food Service)	Room	100
Picnic Park	Visitor	10
Public Restroom	User	3
Residential/Dwelling (i.e., Apartment/Condominium/Individual Dwelling, including Resort Rental and Resort Residence)	Bedroom	120
Residential Care	Resident	100
<u>Residential Out-Building (not used as a dwelling; e.g., pool house, private workshop or garage with private-use bathroom with toilet and sink; barn with hand-wash sink)</u>	<u>1 to 3 Users</u> <u>without washing machine</u>	<u>60</u>
	<u>with washing machine/shower</u>	<u>120</u>
School -With Cafeteria, Gym & Showers -With Cafeteria only -Without Cafeteria, Gym or Showers -Boarding School	Student	15
	Student	10
	Student	8
	Person	60
Stadium (Not Including Food Service)	Seat/Occupancy	3
Swimming Area Bathhouse	Person	10
Visitor Center	Visitor	5

The peak flow rate (~~GPD~~ gpd) for non-residential facilities may either be increased or reduced when comparable peak water consumption data for similar establishments in similar locations vary from the requirement. When considering such data, at least twelve (12) consecutive months must be presented with the maximum month of consumption and the days of operation per month being utilized to arrive at the peak flow rate (~~GPD~~ gpd).

~~600 APPENDIX S — ONSITE WASTEWATER PUMP SYSTEM STANDARD~~ **502 Onsite Wastewater Pump System Standard**

~~600.1 PUMP TANK (GENERAL)~~ **502.1 Pump Tank (General)**

- (1) The submersible sewage effluent pump(s) must be housed in a properly vented, watertight tank that is readily accessible from the surface.
- (2) A watertight access opening with removable lid shall be provided, and shall be designed and maintained to prevent surface water inflow. Risers and other pump tank sections, where present, shall be

joined using mastic, butyl rubber, or other pliable sealant that is waterproof, corrosion-resistant, and approved for use in septic tanks.

(3) When the pump tank must be located in an area characterized by a shallow zone of seasonal saturation, the Department may require the use of a pre-cast manhole, a fiberglass or polyethylene basin, or any other acceptable method for preventing groundwater intrusion.

(4) When the pump tank must be located in an area that is environmentally sensitive or subject to flooding, applicable portions of ~~R. 61-67~~ R. 61-67, Standards for Wastewater Facility Construction, shall apply.

(5) The pump tank shall have sufficient capacity to accommodate all level control and alarm switches; to keep the pump(s) totally submersed in liquid at all times; and to provide the required dosing volume and minimum pump run time. It is strongly recommended that pump tank capacities be as large as possible (~~i.e., e.g.,~~ e.g., 500-1000 gal.) in order to provide emergency storage in the event of pump or power failure.

(6) Pre-engineered, manufactured packaged pump stations can be utilized in lieu of the composite design described herein, provided the pump meets the minimum capacity requirements of the system and no alterations are made to the pump station other than those specifically authorized by the manufacturer.

~~600.2 MINIMUM PUMPING RATES (PEAK INFLOW) AND MINIMUM RUN TIMES~~ 502.2  
Minimum Pumping Rates (Peak Inflow) and Minimum Run Times

(1) For residential systems, the maximum daily flow entering the pump tank shall be based upon one hundred twenty (120) gpd per bedroom. For commercial and other facilities, this value shall be based upon ~~the Standard for Determining Sewage Flow Rates from Commercial and Recreational Establishments Section 501, Peak Sewage Flow Rate Standard.~~

(2) The minimum pumping rate (peak inflow) for discharges up to fifteen hundred (1500) gpd shall be determined as follows:

<u>Maximum Estimated Daily Flow (gpd)</u>	<u>Minimum Pumping Rate (peak inflow) (gpm)</u>
480 and less	10
481 - 720	15
721 - 1500	20

(3) The minimum pumping rate (peak inflow) for discharges in excess of fifteen hundred (1500) gpd shall be determined by multiplying the average flow rate (gpm) times a peaking factor of not less than 2.5, where the average flow rate is based upon actual minutes per day of facility operation.

(4) The minimum pump run time for all pump systems shall be determined as follows:

<u>Minimum Pumping Rate (peak inflow) (gpm)</u>	<u>Minimum Pump Run time (min)</u>
10 - 14	3
15 - 24	4
25 and above	5

~~600.3 MINIMUM DOSING VOLUME, SCOURING VELOCITY, AND PUMP CAPACITY~~ 502.3  
Minimum Dosing Volume, Scouring Velocity, and Pump Capacity



(1) The minimum dosing volume (gal) shall be determined by multiplying the minimum pumping rate (gpm) times the minimum pump run time (min).

(2) The selected pump(s) must have the capacity to deliver the minimum pumping rate (gpm) at a scouring velocity of at least one (1) ft/sec (effluent) or two (2) ft/sec (raw) against the total dynamic head of the system. This minimum pump capacity (gpm at total feet of dynamic head) shall be specified on SCDHEC Form 1739.

(3) Duplex pumps shall be required when the maximum estimated daily flow is equal to or greater than fifteen hundred (1500) gallons, and each pump shall meet the minimum capacity as stated above.

(4) In those cases where the minimum pump capacity or any other system requirements exceed what can be specified ~~thru~~ through the use of this Standard, the Department shall require the applicant to retain the services of a Registered Professional Engineer.

#### ~~600.4 FORCE MAIN, VALVES, AND FITTINGS~~ 502.4 Force Main, Valves, and Fittings

(1) The force main shall be Schedule 40 PVC, and the diameter shall be sufficient to provide a velocity of at least one (1) ft/sec (effluent) or two (2) ft/sec (raw) using a C Factor of 150 (effluent) or 140 (raw) at the minimum pumping rate (peak inflow). The force main shall be installed a minimum of eight (8) inches below the ground surface. Fittings and valves shall be of compatible corrosion resistant material.

(2) A threaded union, flange, or similar disconnect device shall be provided in each pump discharge line. The pump(s) shall be easily removable at ground surface without requiring entrance into the tank. Valves shall also be readily accessible from the ground surface. Duplex pump systems shall be equipped with a separate pit or box for the placement and operation of valves.

(3) A shutoff valve (e.g., gate valve) and a check valve shall be located on the discharge line from each pump. The check valve shall be placed between the pump and the shutoff valve.

(4) A three-sixteenths (3/16) inch anti-siphon hole(s) shall be placed between the pump(s) and the check valve(s) when the discharge elevation of the distribution system is below the inlet to the pump tank.

(5) In cases where the force main must be installed over undulating terrain, automatic air relief valves shall be placed at high points in the line to prevent air locking.

(6) Exposed force mains crossing ditches and bodies of water (e.g., creeks and wetlands) and force mains under driveways and parking areas must be protected by encasing them within a larger diameter pipe that can withstand potential damage (e.g., galvanized pipe, steel pipe, ductile iron). Force mains under driveways and parking areas may also be protected by encasing them within a larger diameter schedule 80 PVC pipe. The protective piping should extend beyond the area of needed protection for at least ten (10) linear feet.

~~(6)~~ (7) The force main effluent shall discharge into a separate discharge box or distribution manifold before entering either a septic tank or a soil wastewater infiltration trench. The flow shall be directed to the bottom of the box ~~thru~~ through a PVC elbow, or into a distribution manifold at an angle of ninety (90) degrees to the septic tank or first wastewater infiltration trench.

#### ~~600.5~~ 502.5 Pumps, Control Devices and Electrical Connections

(1) Pumps shall be listed by Underwriter's Laboratory or an equivalent ~~third-party~~ third-party testing and listing agency, and shall be specifically manufactured for use with domestic wastewater.

(2) Sealed mercury control floats or similar devices designed for detecting liquid levels in septic tank effluent shall be provided to control pump cycles. A separate level sensing device shall be provided to activate an audible and visible high water alarm. Pump-off levels shall be set to keep the pump submerged at all times.

(3) Pump and control circuits shall be provided with manual circuit disconnects within a watertight, corrosion resistant, outside enclosure (NEMA 4X or equivalent) adjacent to the pump tank, securely mounted at least twelve (12) ~~in.~~ inches above finished grade, unless installed within a weather-tight building. Alarm circuits shall be supplied ahead of any pump overload or short circuit protective devices. The pump(s) shall be manually operable without requiring special tools or entrance into the tank for testing purposes. Conductors shall be conveyed to the disconnect enclosure through water proof, gas proof, and corrosion resistant conduit(s), with no splices or junction boxes provided inside the tank. Wire grips, duct seal, or other suitable material shall be used to seal around wire and wire conduit openings inside the pump tank and disconnect enclosure.

(4) For systems requiring duplex pumps, each pump shall operate in a lead-lag sequence and be on an alternating cycle. A control panel shall be provided which shall include short circuit protection for each pump and for the control system, independent disconnects, automatic pump sequencer, hands-off-automatic (H-O-A) switches, run lights, and elapsed time counters for each pump.

#### ~~600.6 FINAL INSPECTION AND APPROVAL~~ 502.6 Final Inspection and Approval

(1) Before or during final inspection, the property owner or agent shall provide literature, including a pump curve, describing the specific pump installed. The inspector shall evaluate the system in accordance with this Standard, and shall confirm that all items, including the minimum pump capacity specified on SCDHEC Form 1739, have been satisfied.

(2) Prior to final approval, the installer or electrician shall provide the Department with written documentation verifying that pump system electrical connections were made in accordance with all applicable codes. The Department may require testing of the pump system, demonstration of watertight integrity, or any other procedure deemed necessary to confirm the acceptability of the installation.

#### ~~600.7~~ 502.7 Raw Sewage Pump Stations

(1) In those cases where it is necessary to pump raw sewage from a residence or facility to an onsite wastewater system, the pump station shall meet all applicable portions of this Standard and ~~R. 61-67~~ R.61-67, Standards for Wastewater Facility Construction.

(2) Adherence to the pump manufacturer's recommendations shall also be a major consideration with such systems.

### ~~700 APPENDIX T MINIMUM DESIGN STANDARDS FOR TANK CONSTRUCTION~~ **503** **Minimum Design Standards for Tank Construction**

#### ~~700.1 INTRODUCTION~~ 503.1 Introduction

The following standards describing tank designs intended to be utilized for septic tanks, grease traps, or pump chambers for onsite wastewater disposal systems have been adopted in an effort to assure a quality product of sufficient strength and resistance, capable of fulfilling its intended purpose.

~~700.2 DESIGN APPROVAL~~ 503.2 Design Approval

(1) No person shall manufacture tanks intended to be utilized for septic tanks, grease traps, or pump chambers for onsite wastewater disposal systems without receiving approval from the Department. All manufactured tanks must receive approval of design and reinforcement methods prior to manufacturing.

(2) Any person desiring to manufacture tanks shall ~~make~~ submit a written application on forms provided by the Department. Such application shall include the name and address, the location of the facility, tank capacity, and design information.

(3) Prior to approval, the Department shall review the tank design, reinforcement, and manufacturing methods to determine compliance.

(4) The Department shall approve plans for manufactured tanks to insure compliance with the South Carolina Minimum Design Standards for Tank Construction.

(5) The Department shall approve plans for fabricated tanks, other than those for precast reinforced concrete tanks, on an individual basis. Fabricated tanks shall meet the requirements of precast reinforced concrete tanks to provide equivalent effectiveness.

(6) The Department shall issue an approval to the tank manufacturer if the tank design, reinforcement and manufacturing method complies with the South Carolina Minimum Design Standards for Tank Construction. Tank manufacturing approvals are not transferable. When a change of ownership occurs, the new owner shall ~~make~~ submit a written application on forms provided by the Department.

(7) The Department shall revoke approval to manufacture tanks for onsite wastewater disposal systems if the tank manufacturer fails to comply with the South Carolina Minimum Design Standards for Tank Construction.

~~700.3 GENERAL~~ 503.3 General

(1) Septic tanks and grease traps shall be manufactured as single compartment or partitioned tanks.

(2) If septic tanks and grease traps are manufactured with a partition so that the tank contains two (2) compartments, the inlet compartment of the tank shall contain two-thirds (2/3) of the overall capacity, and the outlet compartment shall contain one-third (1/3) of the overall capacity. The top of the partition shall terminate two inches below the bottom side of the tank top in order to leave space for air or gas passage between compartments. The top and bottom halves of the partition shall be constructed in such manner as to leave a four (4) inch water passage at the vertical ~~mid-point~~ mid-point of the partition wall for the full width of the tank.

(3) The minimum liquid capacity requirements shall be met by the use of a single septic tank or two or more tanks installed in series. Septic tanks joined in series shall be interconnected by an upper effluent pipe(s) with a minimum diameter of four (4) inches and a lower sludge pipe(s) with a minimum diameter of twelve (12) inches. The upper connection(s) shall be installed level from tank to tank, and the lower sludge pipe connection(s) shall be installed level and shall be placed twelve (12) inches above the bottoms of the tanks. The lower sludge pipe connection(s) can be eliminated if the first tank in series contains at

least two-thirds of the total required liquid capacity. There shall be no more than two (2) inches of fall from the inlet invert of the first tank to the outlet invert of the last tank in series.

(4) It is required that all pump chambers function as a single compartment tank. If a two (2) compartment tank is used, at least two (2) six (6) inch diameter holes or equivalent, must be provided in the partition wall six (6) inches from the tank bottom.

(5) The septic tank and grease trap tank length shall be at least two (2) but not more than three (3) times the width.

(6) The liquid depth shall not be less than four (4) feet.

(7) A minimum of nine (9) inches of freeboard shall be provided in all tanks, unless otherwise approved by the Department.

(8) Useable liquid capacity for septic tanks or grease traps shall not be less than one thousand (1000) gallons.

(9) The pump tank shall have sufficient capacity to accommodate all level control and alarm switches; to keep the pump(s) totally submersed in liquid at all times; and to provide the required dosing volume and minimum pump run time. It is strongly recommended that pump tank capacities be as large as possible in order to provide emergency storage in the event of pump or power failure.

(10) There shall be a minimum of two (2) openings in the tank wall, located at the inlet and outlet ends of the tank. The knockouts for the inlet and outlet openings of pre-cast tanks shall have a concrete thickness of not less than one (1) inch in the tank wall. The openings shall allow for a minimum of four (4) inch pipe or a maximum of six (6) inch pipe. No openings shall be permitted below the tank liquid level.

(11) The inlet and outlet for septic tanks and grease traps shall be a cast-in-place concrete tee, a polyvinyl chloride (PVC) tee, or a polyethylene (PE) tee, made of not less than Schedule 40 pipe or equivalent fittings and material. The cast-in-place concrete tees shall have a minimum thickness of not less than two (2) inches. The invert of the outlet shall be at least two (2) inches lower in elevation than the invert of the inlet. The inlet and outlet tees shall extend above liquid depth to approximately one (1) inch from the top of the tank to allow venting between tank compartments and multiple tank configurations.

(12) The inlet tee for septic tanks and grease traps shall extend sixteen (16) inches below the liquid level.

(13) The outlet tee for a septic tank shall extend eighteen (18) inches below the liquid level and the outlet tee for a grease trap shall extend between six (6) and twelve (12) inches above the tank bottom.

(14) The inlet, outlet, and wiring conduit openings of all tanks must utilize a resilient, watertight, non-corrosive connective sleeve. The use of grout is prohibited.

(15) Access to each tank or compartment shall be provided by an opening located above the inlet and outlet with an inside dimension of at least eighteen (18) inches square (18 x 18) or in diameter, with removable tank access lids.

(16) Concrete tank access lids shall be equipped with steel lift rings at least three-eighths (3/8) inch diameter, or by an alternative method approved by the Department.

(17) Should risers or manholes be utilized to allow access into septic tanks, grease traps, or pump chambers, the risers/~~manholes~~ or manhole covers, as applicable, shall be constructed to prevent the release of odors, entry of vectors, and water. Grade level riser/manhole covers shall be secured by bolts or locking mechanisms, or have sufficient weight to prevent unauthorized access. The ground shall slope away from any access extended to grade level.

(18) Risers/manholes shall be sealed to the tank by using bituminous mastic, butyl rubber, or other pliable sealant that is waterproof, corrosion-resistant, and approved for use in tank construction. The sealant shall have a minimum size of one (1) inch diameter or equivalent. The joint shall be smooth, intact, and free of all deleterious substances before sealing.

(19) After curing, all multi-piece tanks shall be joined and sealed at the joints by using a bituminous mastic, butyl rubber, or other pliable sealant that is waterproof, corrosion-resistant, and approved for use in tank construction. The sealant shall have a minimum size of one (1) inch diameter or equivalent. The joint shall be smooth, intact, and free of all deleterious substances before sealing. The use of grout is prohibited.

(20) All tanks must pass the ASTM C-1227 Standard for watertight testing. The Department will choose tanks at random for testing. Tanks will be approved for use in South Carolina after the Department ascertains that the standard is met. After joining, tanks manufactured in multiple sections shall be plastered along the section joints with hydraulic cement or other waterproofing sealant. Other methods of waterproofing tanks may be used as specifically approved in the plans and specifications for the tank. Prior to backfilling, the ~~local health department~~ Department shall make a finding that multiple section tanks are watertight if a soil wetness condition is present within five feet of the elevation of the top of the tank. Any tank found to be improperly sealed, having cracks or holes, which will allow for water infiltration or discharge of sewage from the tank bottom, walls, or top, will not be approved for use.

(21) Tank manufacturers must have equipment and capabilities for portion control to maintain constant mixture formulation ratios and provide for systematic inspection of finished products to insure compliance with the minimum tank construction and design standards.

(22) The concrete mix used for concrete tank components must be formulated to yield a minimum twenty-eight (28) day compressive strength of four thousand (4,000) pounds per square inch (psi).

(23) The aggregate size utilized in the concrete mix shall not exceed one-third (1/3) of the wall thickness. Suitable aggregates include sand particle sizes from a fine to one-fourth (1/4) inch gravel or crushed stone. Granite dust or fine screenings from a crusher operation may be used in lieu of sand.

(24) An identifying seal must be cast or permanently affixed by an approved method from the Department on the outlet tank wall within six (6) inches of the top. The identifying seal shall identify the manufacturer and the liquid capacity of the tank. The tank's cast date shall be located on the identifying seal or imprinted on the top of the tank within six (6) inches from outlet tank wall near the identifying seal. The lettering on the identifying seal or date imprinted on the top of the tank shall be no more than six (6) inches in height.

(25) The tank manufacturer shall guarantee all tanks in writing for two (2) years against failure due to poor workmanship and materials.

(26) Changes in approved tank design, construction, and alternative reinforcing methods will not be allowed without prior approval from the Department.

~~700.4 PRE-CAST CONCRETE NON-FIBER REINFORCED SEPTIC TANKS AND GREASE TRAPS~~  
503.4 Pre-Cast Concrete Non-Fiber Reinforced Septic Tanks and Grease Traps

(1) The tank walls and bottom shall be reinforced with six inch by six inch (6 x 6) ten (10) gauge wire mesh.

(2) Tank tops shall be reinforced with six by six inch (6 x 6) ten (10) gauge wire mesh, a minimum of five (5) sections of three-eighths (3/8) inch diameter steel reinforcing bars oriented perpendicular to the tank sidewalls beginning at the center spaced twelve (12) inches apart, and four (4) sections of three-eighths (3/8) inch diameter steel reinforcing bars placed diagonally from the corners to the center of the tank. The length of the perpendicular reinforcing bars shall be of sufficient length to extend two (2) inches into the sidewall. The length of the four (4) diagonal steel reinforcing bars shall be of sufficient length to extend two (2) inches into the sidewall and six (6) inches beyond the closest perpendicular steel reinforcing bar.

(3) If a septic tank or grease trap is manufactured with a partition, the tank partition (both halves) shall be reinforced with six by six inch (6 x 6) ten (10) gauge wire mesh. The reinforcing wire shall be bent to form an angle of ninety (90) degrees on the ends in order to form a leg not less than four (4) inches long. When the wire is placed in the mold, the four-inch legs shall lay parallel with the sidewall wire and adjacent to it.

(4) The tank walls and bottom thickness shall be at least two and one-half (2½) inches, and top thickness shall be at least three (3) inches.

(5) All reinforcing wire and rods must be covered by at least one-half (1/2) inch of concrete.

(6) An acceptable vibration method shall be employed in the construction of the tank to prevent voids in the tank walls, bottom and top.

~~700.5 PRE-CAST CONCRETE FIBER REINFORCED SEPTIC TANKS AND GREASE TRAPS 503.5~~  
Pre-Cast Concrete Fiber Reinforced Septic Tanks and Grease Traps

(1) Tank tops shall be reinforced with a minimum of five (5) sections of three-eighths (3/8) inch diameter steel reinforcing bars oriented perpendicular to the tank sidewalls beginning at the center spaced twelve (12) inches apart, and four (4) sections of three-eighths (3/8) inch diameter steel reinforcing bars placed diagonally from the corners to the center of the tank. The length of the perpendicular reinforcing bars shall be of sufficient length to extend two (2) inches into the sidewall. The length of the four (4) diagonal steel reinforcing bars shall be of sufficient length to extend two (2) inches into the sidewall and six (6) inches beyond the closest perpendicular steel reinforcing bar.

(2) Tank bottoms shall be reinforced with a minimum of seven (7) sections of three-eighths (3/8) inch diameter steel reinforcing bars oriented perpendicular to the tank sidewalls beginning at the center spaced twelve (12) inches apart. The length of the perpendicular reinforcing bars shall be of sufficient length to extend two (2) inches into the sidewall.

(3) If a septic tank or grease trap is manufactured with a partition, the tank partition (both halves) shall be reinforced with six by six inch (6 x 6) ten (10) gauge wire mesh. The reinforcing wire shall be bent to form an angle of ninety (90) degrees on the ends in order to form a leg not less than four (4) inches long. When the wire is placed in the mold, the four-inch legs shall lay parallel with the sidewall wire and adjacent to it.

(4) The tank perimeter walls shall be reinforced with three-eighths (3/8) inch diameter steel reinforcing bars located one (1) inch from the tank's top and bottom section seams.

(5) The tank walls and bottom thickness shall be at least two and one-half (2½) inches, and top thickness shall be at least three (3) inches.

(6) All reinforcing wire and rods must be covered by at least one-half (1/2) inch of concrete.

(7) Fiber products used with this reinforcement design must be added during the mixing process in order to achieve even distribution throughout the concrete mixture.

(8) Fiber length must range from at least one (1) to no more than two (2) inches.

(9) The fiber must be specifically manufactured for use as a concrete secondary reinforcement and be a polypropylene fibrillated (two-dimensional fiber mesh network) material.

(10) An acceptable vibration method shall be employed in the construction of the tank to prevent voids in the tank walls, bottom and top.

~~700.6 CONCRETE BLOCK SEPTIC TANKS AND GREASE TRAPS~~ 503.6 Concrete Block Septic Tanks and Grease Traps

(1) The tank walls and partition thickness shall be at least eight (8) inches and the top cover slabs thickness shall be at least four (4) inches.

(2) The tank bottom shall be a single pour concrete slab to a depth of at least four (4) inches within the first block course.

(3) If a septic tank or grease trap is manufactured with a partition, the tank walls and partition shall be constructed of solid sixteen inch by eight inch by eight inch (16 x 8 x 8) concrete blocks. The use of hollow blocks is prohibited.

(4) All joints between concrete blocks shall be mortared using masonry cement mortar or equivalent. The joints shall have a nominal thickness of three-eighths (3/8) inch.

(5) The upper partition wall may be supported by the use of two inch by four inch by eight (2 x 4 x 8) inch bricks (or equivalent support material) standing on edge located at the block seams of the upper partition wall.

(6) The top cover slabs shall be constructed such that the individual slabs will not exceed two (2) feet in width and the length will be sufficient to extend to the outside tank width with a minimum slab thickness of four (4) inches.

(7) The individual top cover slabs shall be reinforced with a minimum of two (2) sections of three-eighths (3/8) inch diameter steel reinforcing bars oriented perpendicular to the tank sidewalls spaced twelve (12) inches apart from the center. The length of the perpendicular reinforcing bars shall be of sufficient length to extend the full length of the slab.

(8) The end cover slabs shall be constructed such that the individual slabs will not exceed three (3) feet in width and the length will be sufficient to extend to the outside tank width with a minimum slab thickness of four (4) inches.

(9) The end cover slabs shall be cast to allow access to each tank or compartment by providing an opening located above the inlet and outlet tee with an inside dimension of eighteen (18) inches square (18 x 18) or in diameter with removable tank access lids.

(10) The individual end cover slabs shall be reinforced with two (2) sections of three-eighths (3/8) inch diameter steel reinforcing bars oriented perpendicular to the tank sidewalls spaced twelve (12) inches apart from the center and two (2) sections of three-eighths (3/8) inch diameter steel reinforcing bars oriented perpendicular to the tank sidewalls spaced sixteen (16) inches apart from the center. The length of the perpendicular reinforcing bars shall be of sufficient length to extend the full length of the slab.

(11) The top and end cover slab seams shall be sealed to the tank walls and at all joints by using a bituminous mastic, butyl rubber, or other pliable sealant that is waterproof, corrosion-resistant, and approved for use in septic tanks. The sealant shall have a minimum size of one (1) inch diameter or equivalent. The use of grout is prohibited.

(12) The tank top and end cover slabs shall be equipped with steel lift handles at least one half (1/2) inch diameter, or by an alternative method approved by the Department.

(13) All reinforcing rods must be covered by at least one-half (1/2) inch of concrete.

(14) The interior of the tank (walls and bottom) shall be plastered with a waterproofing cement compound.

(15) An acceptable vibration method shall be employed in the construction of the tank to prevent voids in the tank access lids, tank bottom, and top and end slabs.

~~700.7 PRE-CAST CONCRETE NON-FIBER REINFORCED PUMP CHAMBERS 503.7~~ Pre-Cast Concrete Non-Fiber Reinforced Pump Chambers

(1) The tank walls and bottom shall be reinforced with six inch by six inch (6 x 6) ten (10) gauge wire mesh.

(2) Tank tops shall be reinforced with six by six inch (6 x 6) ten (10) gauge wire mesh, a minimum of five (5) sections of three-eighths (3/8) inch diameter steel reinforcing bars oriented perpendicular to the tank sidewalls beginning at the center spaced twelve (12) inches apart, and four (4) sections of three-eighths (3/8) inch diameter steel reinforcing bars placed diagonally from the corners to the center of the tank. The length of the perpendicular reinforcing bars shall be of sufficient length to extend two (2) inches into the sidewall. The length of the four (4) diagonal steel reinforcing bars shall be of sufficient length to extend two (2) inches into the sidewall and six (6) inches beyond the closest perpendicular steel reinforcing bar.

(3) The tank walls and bottom thickness shall be at least two and one-half (2½) inches, and top thickness shall be at least three (3) inches.

(4) All reinforcing wire and rods must be covered by at least one-half (1/2) inch of concrete.

(5) An acceptable vibration method shall be employed in the construction of the tank to prevent voids in the tank walls, bottom, and top.

~~700.8 PRE-CAST CONCRETE FIBER REINFORCED PUMP CHAMBERS 503.8~~ Pre-Cast Concrete Fiber Reinforced Pump Chambers



(1) Tank tops shall be reinforced with a minimum of five (5) sections of three-eighths (3/8) inch diameter steel reinforcing bars oriented perpendicular to the tank sidewalls beginning at the center spaced twelve (12) inches apart, and four (4) sections of three-eighths (3/8) inch diameter steel reinforcing bars placed diagonally from the corners to the center of the tank. The length of the perpendicular reinforcing bars shall be of sufficient length to extend two (2) inches into the sidewall. The length of the four (4) diagonal steel reinforcing bars shall be of sufficient length to extend two (2) inches into the sidewall and six (6) inches beyond the closest perpendicular steel reinforcing bar.

(2) Tank bottoms shall be reinforced with a minimum of seven (7) sections of three-eighths (3/8) inch diameter steel reinforcing bars oriented perpendicular to the tank sidewalls beginning at the center spaced twelve (12) inches apart. The length of the perpendicular reinforcing bars shall be of sufficient length to extend two (2) inches into the sidewall.

(3) The tank perimeter walls shall be reinforced with three-eighths (3/8) inch diameter steel reinforcing bars located one (1) inch from the tank's top and bottom section seams.

(4) The tank walls and bottom thickness shall be at least two and one-half (2½) inches, and top thickness shall be at least three (3) inches.

(5) All reinforcing wire and rods must be covered by at least one-half (1/2) inch of concrete.

(6) Fiber products used with this reinforcement design must be added during the mixing process in order to achieve even distribution throughout the concrete mixture.

(7) Fiber length must range from at least one (1) to no more than two (2) inches.

(8) The fiber must be specifically manufactured for use as a concrete secondary reinforcement and be a polypropylene fibrillated (*two-dimensional fiber mesh network*).

(9) An acceptable vibration method shall be employed in the construction of the tank to prevent voids in the tank walls, bottom, and top.

## ~~800 APPENDIX U fiberglass reinforced plastic tanks STANDARD~~ **504 Fiberglass Reinforced Plastic Tanks Standard**

Standards describing fiberglass reinforced plastic septic tanks have been adopted ~~to insure assure~~ a quality product of sufficient strength and resistance, capable of fulfilling its intended purpose. Many of these standards were derived from NBS Voluntary Product Standard PS 15-69, which covers custom contact-molded reinforced polyester chemical resistant process equipment.

### ~~800.1 GENERAL REQUIREMENTS~~ **504.1 General Requirements**

The following general requirements are applicable to fiberglass reinforced plastic septic tanks as defined ~~herein~~ within this regulation, and approved design standards and structural properties of the same shall be not less than those stated ~~herein~~.

#### (1) Material

Resins and sealants used in the tank manufacturing process shall be capable of effectively resisting corrosive influences of liquid components of sewage, gases generated by the digestion of sewage, and soil burial. Materials used shall be formulated to withstand vibration, shock, normal household chemicals,

earth, and hydrostatic pressure both when full and empty. Not less than thirty (30) percent of the total weight of the tank shall be fiberglass reinforcement. For tanks not exceeding a fifteen hundred (1500) ~~gallons~~ gallon liquid capacity, the minimum wall thickness shall be three-sixteenths (3/16) inch, provided, however, that isolated small spots may be as thin as eighty (80) percent of the minimum.

(2) Inner Coating

Internal surfaces shall be coated with an appropriate gel coating to provide a smooth, pore-free, watertight surface for fiberglass reinforced plastic parts.

(3) Physical Properties

Tanks shall be so constructed that all parts of the tank shall meet the following requirements:

(a) Ultimate Tensile Strength (Minimum) – Nine thousand (9,000) pounds per square inch (psi) when tested in accordance with ASTM D 638-71a, Standard Method of Test for Tensile Properties of Plastics.

(b) Flexural Strength (Minimum) – Sixteen thousand (16,000) psi when tested in accordance with ASTM D 790-71, Standard Method of Test for Flexural Properties of Plastics.

(c) Flexural Modulus of Elasticity Tangent (Minimum) - Seven hundred thousand (700,000) psi when tested in accordance with ASTM D 790-71, Standard Method of Test for Flexural Properties of Plastics.

(4) Watertight Integrity

Tanks shall be so constructed as to be watertight for the designed life of the tank. Lids or covers shall be sufficiently tight when installed to preclude the entrance of surface or ground water into the tank.

(5) Longevity

Proof from an independent testing laboratory shall be submitted substantiating a minimum life expectancy of twenty years service for the intended use of the tank and appurtenant components such as necessary sealants, connective fastenings, resins, etc.;

(6) Safety

As a safety measure, provisions shall be made in the construction of septic tank lids or covers to preclude unauthorized entry or removal when the use of the tank necessitates positioning of access openings at or above ground level.

(7) Workmanship

Tanks shall be of uniform thickness and free from defects that may affect their serviceability or durability. Completed tanks are to ~~present~~ have a smooth inside finish free of spills, pits, and honeycombs. Plant quality control shall be sufficient to maintain a high degree of uniformity in tank quality.

~~800.2 SPECIFIC REQUIREMENTS~~ 504.2 Specific Requirements

Specific requirements for design and construction shall be not less than those specified herein, and shall be in conformity with recognized National Standards for design and construction and in accordance with this regulation.

~~800.3 CAPACITY AND DESIGN LIMITS~~ 504.3 Capacity and Design Limits

(1) Dimensions

(a) The inside length of a horizontal cylindrical tank shall be at least two (2) but not more than three (3) times the width.

(b) The uniform liquid depth shall not be less than four (4) feet.

(c) At least fifteen (15) percent of the total volume of the tank shall be above the liquid level.

(d) If tanks of other shapes are proposed, specifications must be submitted to the ~~Division of Onsite Wastewater Management~~ Department for approval.

(2) Inlet

(a) Provisions shall be made for the building sewer to enter the center of one end of the septic tank two (2) inches above the normal liquid level of the tank.

(b) A tee shall be constructed as an integral part of the tank to receive the building sewer, or as an alternative, an integrally constructed baffle may be used.

(c) If baffles are used, suitable integrally fitted sleeves or collars shall be provided in the inlet openings of the tank to provide surface areas sufficient to insure capability of watertight bonding between the tank and the inlet sewer.

(d) If the tee or baffle is constructed of plastic material, it shall meet NSF Standard #14 for drain, waste, and vent system application.

(e) If fiberglass reinforced plastic is used, it shall be of the same constituency as material of which the tank is constructed.

(f) The inlet tee of the baffle shall extend sixteen (16) inches below the designed liquid level and be placed and secured in a vertical position so as to be watertight and preclude dislodgement during installation, operation, or maintenance activities.

(3) Outlet

(a) Provisions shall be made for the outlet sewer to receive the discharge from the tank by providing an opening in the center of the end of the tank opposite the inlet, the invert elevation of which shall be at the liquid level of the tank.

(b) A tee shall be constructed as an integral part of the tank to connect to the outlet sewer, ~~or,~~ as an alternative, an integrally constructed baffle may be used.

(c) If baffles are used, suitable integrally fitted sleeves or collars shall be provided in the outlet opening of the tank to provide surface areas sufficient to insure capability of water tight bonding between the tank and the outlet sewer.

(d) If the tee or baffle is constructed of plastic material, it shall meet NSF Standard #14 for drain, waste, and vent system application.

(e) If fiberglass reinforced plastic is used, it shall be of the same constituency as material of which the tank is constructed.

(f) The outlet tee or baffle shall extend eighteen inches below the design liquid level and be placed and secured in a vertical position so as to be watertight and preclude dislodgement during installation, operation, or maintenance activities.

(g) A one (1) inch opening between the top of the inlet tee and top of the tank shall be provided to permit free passage of gas back to the house vent.

#### (4) Access Openings

Openings in the top of the septic tank shall be provided over the inlet and outlet tees or baffles with sufficient area to enable maintenance service to such tees or baffles.

#### (5) Identifying Markings

Fiberglass septic tanks shall be provided with a suitable legend, cast or stamped into the wall at the outlet end, and within six inches of the top of the tank, identifying the manufacturer, and indicating the liquid capacity of the tank in gallons.

### ~~900 APPENDIX V THERMOPLASTIC TANKS STANDARD~~ **505 Thermoplastic Tanks Standard**

(1) The Department shall approve plans for thermoplastic tanks on an individual basis.

(a) Thermoplastic tanks shall be certified by an accredited third-party to comply with the most recent edition of IAPMO/ANSI Z1000 or CSA B66.

(b) The uniform liquid depth shall be at least three (3) feet.

(c) The inside length of the tank shall be at least two (2) times the inside width of the tank.

(2) If thermoplastic tanks having other dimensional characteristics are proposed, specifications must be submitted to the ~~Division of Onsite Wastewater Management~~ Department for approval, and the proposed design must be demonstrated to provide equivalent effectiveness for storage and distribution to that of concrete or thermoplastic tanks described in this regulation.

(3) Thermoplastic tank manufacturers must renew their product approvals by submitting new applications and plans every five (5) years and before changing any previously approved plans.

### **600 License to Clean Onsite Wastewater Systems, Self-Contained Toilets, and Other Systems (i.e., Pumper/Hauler)**

600.1 No person may engage in the business of and be responsible for the cleaning of onsite wastewater systems, self-contained toilets, and other sewage holding systems in South Carolina without first applying

for, receiving, and subsequently maintaining a valid license to conduct such activities as herein required by the Department. This includes, but is not limited to, nonwater-carried sewage treatment devices.

#### 600.2 Licenses, Applications, and Fees

(1) License applications, on forms approved by the Department, shall be submitted to the Department in the county where the applicant's primary place of business is located; provided, persons residing out of state must submit their applications to the Department in the South Carolina county where it is reasonably anticipated the bulk of the activities sought to be licensed would occur.

(2) The following shall apply to applications submitted by persons engaged in the business of cleaning onsite wastewater systems, self-contained toilets, and other sewage holding systems:

(a) The applicant shall list on the application form each approved septage and sewage disposal facility they intend to use. Written verification of permission to use each disposal facility shall accompany the application.

(b) For each annual renewal of an existing license, the person seeking renewal shall submit changes to the Department through an updated application.

(c) Upon request by the Department, each person seeking a new license or renewal of an existing license shall make available for inspection all vehicles and equipment used in the pumping and transporting of septage and sewage.

(d) Additional inspections of vehicles and equipment may be conducted by the Department to ensure compliance with this regulation.

(e) If a licensee replaces, deletes, or adds to their inventory of vehicles used in pumping and transporting septage or sewage, the licensee shall immediately notify the Department for the purpose of updating their application. A vehicle may not be placed into use without prior inspection and approval from the Department. A license holder is required to report to the Department all locations where pumping and transporting vehicles are parked/stored when not in use.

(3) Prior to receipt of a license authorizing a person to engage in the business of and be responsible for the cleaning of onsite wastewater systems, self-contained toilets, and other sewage holding systems, applicants shall be required to complete an examination demonstrating their knowledge and comprehension of R. 61-56, Onsite Wastewater Systems. A non-refundable processing fee of fifty dollars (\$50.00) is required each time the examination is taken prior to taking the examination. Any applicant failing to satisfactorily complete the licensing examination may be eligible to retake the examination after thirty (30) days. Applicants who fail to satisfactorily complete their second examination may then be allowed to retake subsequent examinations after a sixty (60)-day waiting period.

(4) A fee shall be assessed for a new license and for the annual renewal of a license.

(a) No person who seeks to engage in the business of cleaning of onsite wastewater systems, self-contained toilets, and other sewage holding systems shall be issued a new license pursuant to this regulation until a fee of two hundred dollars (\$200.00) has been paid to the Department. The license fee includes the initial inspection of one (1) pumping and transporting vehicle. Additional pumping and transporting vehicles shall be assessed initial inspections fees of twenty-five dollars (\$25.00) per vehicle.

(b) Every license issued by the Department under this regulation shall be valid for a period of one (1) year, unless otherwise suspended or revoked.

(c) Each licensee must pay an annual renewal fee of two hundred dollars (\$200.00). The new license or annual renewal fee includes the annual inspection of one (1) pumping or transporting vehicle. Additional vehicles shall be assessed an annual inspection fee of twenty-five dollars (\$25.00) per pumping and transporting vehicle.

(d) Annual renewal fees shall be due on a date not less than thirty (30) days from the billing date. A penalty charge of fifty dollars (\$50.00) shall be assessed for license fees that are past due. A second penalty of one hundred dollars (\$100.00) shall be assessed for license fees sixty (60) days past due.

(e) Expiration of a license shall occur when the license fee is ninety (90) days past due. No person with an expired license may be engaged in the business of cleaning onsite wastewater systems, self-contained toilets, and other sewage holding systems.

(f) An expired license shall not be renewed. Any person with an expired license may apply for a new license and must meet all applicable requirements for a new license.

(5) Licenses issued in accordance with this regulation shall not be transferable.

#### 600.3 Further Governmental Restriction Not Prohibited

Nothing within this regulation shall be construed to limit the power of any municipal, county, or governmental entity to enforce other license requirements or additional measures for the restrictions of persons cleaning onsite wastewater systems, self-contained toilets, and other sewage holding systems.

#### 600.4 License Not Required

Public or private sewer providers using pumping and transporting vehicles for the sole purpose of maintaining their sewer systems shall be exempt from the licensing requirements of Section 600 of this regulation. This exemption does not apply to public or private sewer providers using pumping and transporting vehicles to provide cleaning services to the public.

### **601 Vehicles, Equipment, and Practices**

601.1 All vehicles and equipment used to remove and transport septage and sewage shall be maintained in a manner that will prevent the occurrence of leaks, spills, and other nuisance conditions which are a hazard to the public health and the environment. All vehicles shall be properly identified.

(1) Hoses, valves, tanks, and other equipment must be maintained in good repair and working order.

(2) All vehicles used to transport septage and sewage must bear the company name and license number in a prominent place on the sides and rear of each vehicle, using letters and numbers that are at least four (4) inches in height.

601.2 The cleaning of septic tanks and similar units and the pumping and transporting of septage and sewage shall be done in a manner that is safe and does not create a hazard to the public health and the environment. The proper cleaning of any septic tank or similar unit shall include the substantial removal of its contents (solids, semi-solids, and liquids).

601.3 Disposal of septage and sewage shall be allowed only at facilities approved by the Department. A licensee may dispose of septage and sewage only at those approved facilities designated by the licensee's application and any renewals or updates of the application.

(1) Discharge of septage and sewage shall be allowed only at those specific locations designated by the owners/operators of approved disposal facilities.

(2) Discharge of septage and sewage into a public sewage collection system, without the consent and permission of the owner/operator of such system, is prohibited.

601.4 A licensee shall adequately supervise employees to ensure that onsite wastewater systems, self-contained toilets, and other sewage holding systems are cleaned in accordance with this regulation and other applicable regulations, permits, and standards issued by the Department.

## **602 Records of Operation**

602.1 Each person licensed to clean onsite wastewater systems, self-contained toilets, and other sewage holding systems is required to maintain accurate records of cleaning and transporting activities.

(1) Records shall be kept current and shall include at least the following information for each cleaning/transporting activity:

(a) Date and time of septage and sewage removal.

(b) Name and address of residence or facility where septage and sewage was removed. Where one or more self-contained toilets are cleaned at one location (e.g., construction site, special event, etc.), one recorded entry per location will be acceptable.

(c) Quantity and type of septage and sewage removed (e.g., grease trap, septic tank, self-contained toilet, etc.). Where one or more self-contained toilets are cleaned at one location, quantity may be expressed by the total number of units cleaned at that location.

(d) Date, time, and location of septage and sewage disposal.

602.2 Records shall be made available for inspection by the Department upon request. All licensees must retain their records for a minimum of two (2) years.

## **700 Licensing of Installers**

### **700.1 License Requirements and Fees**

(1) No person may engage in the business of and be responsible for the construction or repair of onsite wastewater systems in South Carolina without first applying for, receiving, and subsequently maintaining a valid license to conduct such activities as herein required by the Department; provided, that a person may construct or repair an onsite wastewater system for personal use at the person's residence without obtaining a license.

(2) Licenses, Applications, and Fees

(a) License applications, on forms approved by the Department, shall be submitted to the Department.

(b) Prior to receipt of a license authorizing a person to engage in the business of and be responsible for the construction or repair of an onsite wastewater system, the applicant shall complete an examination demonstrating the applicant's knowledge and comprehension of the onsite wastewater regulation (R.61-56). A non-refundable processing fee of fifty dollars (\$50.00) is required each time the examination is taken prior to taking the examination. Any applicant failing to satisfactorily complete the licensing examination may be eligible to retake the examination after thirty (30) days. Applicants who fail to satisfactorily complete their second examination may then be allowed to retake subsequent examinations after a sixty (60)-day waiting period.

(c) Each license requires fees for the initial license issuance and renewal every two (2) years. The required fees vary depending on the tier of licensure sought. The required initial license and renewal fees for each tier are as follows

(i) Tier 1 – Four hundred dollar (\$400.00) fee

(ii) Tier 2 – Five hundred dollar (\$500.00) fee

(iii) Tier 3 – Seven hundred dollar (\$700.00) fee

(d) Every license issued by the Department under this regulation shall be valid for a period of two (2) years, unless otherwise suspended or revoked.

(e) Renewal fees shall be due on a date not less than thirty (30) days from the billing date. A penalty charge of fifty dollars (\$50.00) shall be assessed for license fees that are past due. A second penalty of one hundred dollars (\$100.00) shall be assessed for license fees sixty (60) days past due.

(f) Expiration of a license shall occur when the license fee is ninety (90) days past due. No person with an expired license may be engaged in the business of constructing and repairing onsite wastewater systems, sewage holding systems, or self-contained toilets.

(g) An expired license shall not be renewed. Any person with an expired license may apply for a new license and must meet all applicable requirements for a new license.

(h) Licenses issued in accordance with this regulation shall not be transferable.

### (3) Further Governmental Restriction Not Prohibited

Nothing within this regulation shall be construed to limit the power of any municipal, county, or governmental entity to enforce other license requirements or additional measures for the restrictions of persons constructing or repairing onsite wastewater systems.

### (4) Eligibility

Only a person who meets the following criteria is eligible to be licensed as an onsite wastewater systems installer:

(a) Applicants to be a Tier 1 or Tier 2 Installer must:

(i) Pass an examination administered by the Department with a minimum score of eighty (80) percent ; and,



(ii) Submit a properly completed application with supporting documents including proof of continuing education units (CEUs) for any renewal; and,

(iii) Pay applicable fees.

(b) Applicants to be a Tier 3 Installer must:

(i) Qualify as either:

(A) A licensed onsite wastewater system installer who has been actively installing for three (3) years immediately preceding the date of application with no disciplinary or enforcement action pending involving onsite wastewater system contracting; or,

(B) An onsite wastewater system installer licensee from another state with affidavits from the regulatory authority demonstrating five (5) years of experience with no pending disciplinary or enforcement action involving onsite wastewater system contracting; and,

(ii) Pass an examination administered by the Department with a minimum score of eighty (80) percent; and,

(iii) Submit a properly completed application with supporting documents (if required); and,

(iv) Submit proof of continuing education units (CEUs) for any renewal; and

(v) Submit proof of required bond and insurance coverage; and,

(vi) Pay applicable fees.

## **701 Continuing Education and Training**

701.1 All installers are required to complete the necessary number of continuing education units (CEUs) every two (2) years from the date of licensing to renew the installer license. CEUs must be obtained from the Department approved list of courses and providers.

701.2 The Department will not renew a license for any installer who has failed to meet the training and education requirements for the previous licensing period.

701.4 If any installer completes more than the required hours in a licensing period, as many as three (3) hours can be rolled over and credited to the requirement for the next licensing period.

701.5 The required CEUs for each Tier for every two-year licensing period are as follows:

(1) Tier 1: Eight (8) hours

(2) Tier 2: Twelve (12) hours

(3) Tier 3: Eighteen (18) hours

701.6 Implementation of CEU Requirement

The requirement for CEUs will enter into effect for any initial or renewal licensing period beginning on or after the date three (3) years following the effective date of this regulation.

## **702 Practice, Procedure, and Quality Control**

### 702.1 Practices: All Installers

(1) Onsite wastewater systems must be installed pursuant to and in compliance with construction and operation permits issued by the Department.

(2) An installer does not have the authority to make any changes to a construction or repair project that deviate from an issued permit without first obtaining Department approval.

(3) Installers do not have the authority to subcontract unlicensed installers to conduct work under their licenses.

(4) The specific scope of activities authorized under each tier of licensure is set forth in this regulation's definition of "licensed onsite wastewater system installer." A licensed installer is prohibited from performing any construction or repair that is inconsistent with the scope of activities authorized under the licensee's applicable tier.

### 702.2 Practices and Procedure: Tier 3 Installers

(1) Tier 3 installers authorized under this regulation may install and inspect any systems they install except those systems designed by a Licensed Professional Engineer.

(2) The Tier 3 installer shall give the Department the opportunity to do a final inspection and arrange a time for the final inspection of an onsite wastewater system that is being installed. If, after thirty (30) minutes of that arranged time, the Department representative has not arrived for the inspection, the Tier 3 installer shall:

(a) Inspect the system;

(b) Record the findings on a form approved by the Department;

(c) Cover the system; and,

(d) Place the system into operation.

(3) The installer shall not place into operation any onsite wastewater system that, upon inspection, is determined not to be in compliance with the permit to construct.

(4) The certified as-built plans or Department designated final installation documentation containing the required measurements along with the Tier 3 installer's signature and license number, and other documentation shall be submitted to the Department within two (2) business days of completing the system installation. A copy of this document(s) must also be furnished to the property owner for whom the system was installed.

### 702.3 Quality Control: Tier 3 Installers

The Department will conduct random final inspections on no less than three (3) percent annually of the total number of systems installed during the preceding fiscal year. The Department will also conduct field reviews of the Department designated final installation and inspection documentation submitted by the Tier 3 installer and compare them to the actual installations those documents represent.

### **703 Bonding and Insurance Requirements: Tier 3 Installers**

703.1 Proof of both insurance and bond coverage shall be furnished to the Department prior to licensure as a Tier 3 installer and upon license renewal.

703.2 An onsite wastewater system Tier 3 installer shall be responsible for obtaining and maintaining both insurance and bond coverage for as long as the installer is licensed as a Tier 3 installer.

703.3 Failure to maintain both insurance and bond coverage shall result in the suspension or revocation of the Tier 3 installer license.

### **704 Enforcement**

704.1 Violations of this regulation shall be punishable in accordance with Sections 44-1-150, 48-1-320, and 48-1-330 of the 1976 Code of Laws of South Carolina, as amended. The Department may seek enforcement, suspend and revoke permits and licenses, issue civil penalties, and order corrective action in accordance with law. The Department shall have the authority to suspend civil penalties if the violations of this regulation are corrected in a period of time established by the Department.

704.2 Deviation from the installation design and conditions in onsite wastewater permits to construct and approvals to operate may be considered a violation of this regulation.

704.3 Suspension and Revocation of Permits to Install and Approvals to Operate an Onsite Wastewater System, Nonwater-Carried Sewage Treatment System, or Wastewater Combustion System

(1) The Department may temporarily suspend a permit to construct or approval to operate for a violation of this regulation.

(2) The Department may revoke a permit to construct or approval to operate for a violation of this regulation. The Department will revoke a permit or approval when:

(a) The onsite wastewater system, nonwater-carried sewage treatment system, or wastewater combustion system is malfunctioning and sewage is discharging to the ground or the groundwater, the holder of the permit has received notice that the system is malfunctioning, the Department has given notice that repairs must be made within a reasonable period of time, the holder of the permit has not made the repairs, and the system continues to discharge sewage to the ground or the groundwater; or

(b) The onsite wastewater system, nonwater-carried sewage treatment system, or wastewater combustion system is malfunctioning and sewage is discharging to the ground or the groundwater, the holder of the permit has received notice that the system is malfunctioning, the Department has given notice that a wastewater treatment facility is accessible for connection.

704.4 Suspension and Revocation of Licenses to Construct, Clean, and/or Repair Onsite Wastewater Systems

(1) A licensee shall be subject to suspension, revocation, and penalties as provided in Sections 704.1 and 704.4(2) for the construction, cleaning, or repair of onsite wastewater systems, self-contained toilets, and other sewage holding systems for which the licensee is responsible for violation of state laws, regulations, and standards.

In determining whether a license should be suspended or revoked, the Department may consider such factors as the seriousness of a violation and whether a violation is a repeat of previous violations, among any other relevant factors. The interference by a licensee or their employees with a representative of the Department in performing their duties with respect to this regulation shall constitute grounds for revocation of license.

(2) Violation of an onsite wastewater system installation permit or any provisions of this regulation by a licensed onsite wastewater system installer or person licensed to clean onsite wastewater systems must be enforced as follows:

(a) First offense violations may be enforced under S.C. Code Section 44-1-150 or by suspension of the license for a period not to exceed one (1) year.

(b) Second offense violations shall be enforced under S.C. Code Section 44-1-150 or by suspension of the license for a period not to exceed three (3) years.

(c) Third offense violations shall be enforced under S.C. Code Section 44-1-150 or by permanent revocation of the license.

704.5 Prior to suspending or revoking a permit to construct, approval to operate, or license, the Department shall provide written notification to the person stating the basis for suspension or revocation. A permit to construct, approval to operate, or license may be summarily suspended by the Department without prior warning if the Department determines there is an immediate threat to public health.

## **705 Severability Clause**

Should any section, paragraph, sentence, clause, or phrase of this regulation be declared unconstitutional or invalid for any reason, the remainder of this regulation shall not be affected thereby.

~~61-56.1 License to Construct or Clean Onsite Sewage Treatment and Disposal Systems and Self-Contained Toilets.~~

### ~~SECTION I. PURPOSE~~

~~To regulate persons engaged in the business of constructing, repairing, or cleaning onsite sewage treatment and disposal systems and cleaning self-contained toilets, to protect public health and the environment.~~

### ~~SECTION II. DEFINITIONS~~

~~—A. Cleaning—the removal and transportation of septage from an onsite sewage treatment and disposal system or self-contained toilet to an approved disposal location.~~

~~—B. Construct—the installation or repair of an onsite sewage treatment and disposal system.~~

~~—C. Department—the South Carolina Department of Health and Environmental Control and its authorized representatives.~~

~~— D. License — the official document issued by the Department authorizing a person to be engaged in the business of construction, repair, or cleaning of onsite sewage treatment and disposal systems or the cleaning of self-contained toilets.~~

~~— E. Onsite Sewage Treatment and Disposal System — a system, or any part of a system, designed to treat and dispose of, or store sewage. Examples include septic tank systems, sewage holding systems, and similar devices.~~

~~— F. Person — any individual, firm, company, corporation, or association.~~

~~— G. Revocation — the permanent withdrawal of rights and privileges granted by a license.~~

~~— H. Self-Contained Toilet — a single or multiple unit toilet and holding tank combination.~~

~~— I. Septage — the mixture of solids and liquids removed during cleaning of a septic tank, grease trap, or any other part of an onsite sewage treatment and disposal system, holding system, or self-contained toilet which receives domestic sewage; includes the liquid, solid and semi-solid materials which settle to the bottom of transport containers.~~

~~— J. Sewage — any liquid waste containing animal, vegetable, or chemical matter in suspension or solution from water closets, urinals, lavatories, bathtubs, laundry tubs or devices, floor drains, drinking fountains or other water-using fixtures.~~

~~— K. Suspension — the temporary or indefinite withdrawal or cessation of rights and privileges granted by a license.~~

### ~~SECTION III. — LICENSE REQUIRED~~

~~— A. No person may engage in the business of and be responsible for the construction, repair, or cleaning of onsite sewage treatment and disposal systems or the cleaning of self-contained toilets in South Carolina without first applying for, receiving, and subsequently maintaining a valid license to conduct such activities, as herein required by the Department; provided, that a person may construct or repair an onsite sewage treatment and disposal system for personal use at his residence without obtaining a license.~~

~~— B. Licenses, Applications, and Fees:~~

~~— 1. License applications, on forms approved by the Department, shall be submitted to the Department in the county where the applicant's primary place of business is located; provided, persons residing out of state must submit their applications to the Department in the South Carolina county where it is reasonably anticipated the bulk of the activities sought to be licensed would occur.~~

~~— 2. The following shall apply to applications submitted by persons engaged in the business of cleaning onsite sewage treatment and disposal systems or self-contained toilets:~~

~~— a. The applicant shall list on the application form each approved septage disposal facility they intend to use. Written verification of permission to use each disposal facility shall accompany the application.~~

~~— b. For each renewal of an existing license, the person seeking renewal shall submit to the Department an updated application.~~

~~\_\_\_\_\_ c. Upon request by the Department, each person seeking a new license or renewal of an existing license shall make available for inspection all vehicles and equipment used in the pumping and transporting of septage.~~

~~\_\_\_\_\_ d. Additional inspections of vehicles and equipment may be conducted by the Department to ensure compliance with this regulation.~~

~~\_\_\_\_\_ e. If a licensee replaces, deletes, or adds to his inventory of vehicles used in pumping and transporting septage, the licensee shall immediately notify the Department for the purpose of updating his application.~~

~~\_\_\_\_\_ 3. Prior to receipt of a license authorizing a person to engage in the business of and be responsible for the construction or repair of an onsite sewage disposal system, the applicant shall complete an examination, demonstrating his knowledge and comprehension of the onsite sewage treatment and disposal regulation (Regulation 61-56, 1976 Code of Laws of South Carolina, as amended). Any applicant failing to satisfactorily complete the licensing examination may be eligible to retake the examination after 30 days. If the applicant fails to satisfactorily complete his second examination, he may then be allowed to retake subsequent examinations after a 60-day waiting period.~~

~~\_\_\_\_\_ 4. Persons engaged only in the business of cleaning onsite sewage treatment and disposal systems, holding systems, or self-contained toilets, shall be exempt from the aforementioned examination, and shall be issued a license upon satisfactory compliance with this regulation.~~

~~\_\_\_\_\_ 5. A fee shall be assessed for a new license and for the annual renewal of license.~~

~~\_\_\_\_\_ a. No person engaged in the business of either constructing and repairing or the cleaning of onsite sewage treatment and disposal systems shall be issued a new license pursuant to this regulation until a fee of one hundred (\$100) dollars has been paid to the Department; provided, persons engaged in the dual business of constructing/repairing and cleaning systems shall pay a fee of one hundred fifty (\$150) dollars. Every license issued by the Department under this regulation shall be valid for a period of one year, unless otherwise suspended or revoked.~~

~~\_\_\_\_\_ b. Each licensee must pay an annual renewal fee of one hundred (\$100) dollars, or, for a dual license, one hundred fifty (\$150) dollars, to the Department.~~

~~\_\_\_\_\_ c. Annual renewal fees shall be due on a date not less than thirty (30) days from the billing date. A penalty charge of \$30.00 shall be assessed for license fees that are past due. A second penalty of \$30.00 shall be assessed for license fees sixty (60) days past due.~~

~~\_\_\_\_\_ d. Expiration of a license shall occur when the license fee is ninety (90) days past due. No person with an expired license may be engaged in the business of either constructing and repairing or cleaning onsite sewage treatment and disposal systems, sewage holding systems, or self-contained toilets.~~

~~\_\_\_\_\_ e. an expired license shall not be renewed. Any person with an expired license may apply for a new license and must meet all applicable requirements for a new license.~~

~~\_\_\_\_\_ 6. Licenses issued in accordance with this regulation shall not be transferable.~~

~~\_\_\_\_\_ C. Further Governmental Restrictions Not Prohibited.~~

~~Nothing within this regulation shall be construed to limit the power of any municipal, county, or governmental entity to enforce other license requirements or additional measures for the restrictions of persons constructing, repairing, or cleaning onsite sewage treatment and disposal systems or cleaning self-contained toilets.~~

#### ~~SECTION IV. VEHICLES, EQUIPMENT, AND PRACTICES~~

~~— A. All vehicles and equipment used to remove and transport septage shall be maintained in a manner that will prevent the occurrence of leaks, spills, and other nuisance conditions. All vehicles shall be properly identified.~~

~~— 1. Hoses, valves, tanks, and other equipment must be maintained in good repair and working order.~~

~~— 2. All vehicles used to transport septage must bear the company name and license number in a prominent place on the sides and rear of each vehicle, using letters and numbers that are at least four (4) inches in height.~~

~~— B. The cleaning of septic tanks and similar units, and the pumping and transporting of septage shall be done in a manner that is safe and does not create a nuisance or health hazard. The proper cleaning of any septic tank or similar unit shall include the substantial removal of its contents.~~

~~— C. Disposal of septage shall be allowed only at facilities approved by the Department. A licensee may dispose of septage only at those approved facilities designated by his application and any renewals or updates of his application.~~

~~— 1. Discharge of septage shall be allowed only at those specific locations designated by the owners/operators of approved disposal facilities.~~

~~— 2. Discharge of septage into a public sewage collection system, without the consent and permission of the owner/operator of such system, is prohibited.~~

~~— D. A licensee shall adequately supervise employees and ensure that all systems for which the licensee is responsible shall be constructed, repaired, and cleaned in accordance with Regulation 61-56 and other applicable regulations, permits, and standards issued by the Department.~~

#### ~~SECTION V. RECORDS OF OPERATION~~

~~— A. Each person licensed to clean onsite sewage treatment and disposal systems and self-contained toilets is required to maintain accurate, written records of cleaning and transporting activities.~~

~~— 1. Records shall be kept current and shall include at least the following information for each cleaning/transporting activity:~~

~~— a. Date and time of septage removal.~~

~~— b. Name and address of residence or facility where septage was removed. Where one or more self-contained toilets are cleaned at one location (construction site, special event, etc.), one recorded entry per location will be acceptable.~~

~~— c. Quantity and type of septage removed (i.e., grease trap, septic tank, self-contained toilet). Where one or more self-contained toilets are cleaned at one location, quantity may be expressed by the total number of units cleaned at that location.~~

~~\_\_\_\_\_d. Date, time, and location of septage disposal.~~

~~\_\_\_\_\_B. Records shall be made available for inspection by the Department upon request. Records must be retained for a minimum of two (2) years.~~

#### ~~SECTION VI. — SUSPENSION/REVOCATION OF LICENSE~~

~~\_\_\_\_\_A. A licensee shall be subject to suspension and revocation of license and to penalties, as provided in Section VIII for the construction, repair, or cleaning of onsite sewage treatment and disposal systems, or cleaning of self-contained toilets for which he is responsible in violation of State Laws, Regulations, and Standards.~~

~~In determining whether a license should be suspended or revoked, the Department may consider such factors as the seriousness of a violation and whether a violation is a repeat of previous violations, among any other relevant factors. The interference by a licensee or his employees with a representative of the Department in performing his duties with respect to this regulation shall constitute grounds for revocation of license. Only the person responsible for supervision and enforcement of this regulation in each county or health district is authorized to initiate action to revoke the license on the grounds of interference.~~

~~\_\_\_\_\_B. Any person whose license is revoked shall not be eligible to apply for relicensing within one year from the date of revocation. Any person whose license has previously been revoked and who obtains a subsequent license and violates the provisions of this regulation, which results in the revocation of his license for the second time, shall not be granted another license.~~

~~\_\_\_\_\_C. Prior to such action, the Department shall provide written notification to the licensee, stating the basis for suspension or revocation, and advise the licensee that the license shall be suspended or revoked on the fifteenth (15th) day following receipt of the written notification, unless a Petition for Administrative Review, complying with the requirements of Regulation 61-72, is filed with the Department, within fifteen (15) days of receipt. All hearings shall be conducted in accordance with the Administrative Procedures Act and Regulation 61-72.~~

~~\_\_\_\_\_D. A license may be summarily suspended by the Department pending a hearing, as herein provided, if the licensee acts in such a manner as to pose an immediate threat to public health. In the case of a summary suspension, the licensee shall be given a hearing as soon as possible after the Department receives a written request for a hearing.~~

#### ~~SECTION VII. — EXPIRATION OF LICENSE~~

~~The expiration of a license due to failure to pay the required annual renewal fee, plus applicable late charges, shall not constitute a contested case and shall not create a right to a hearing pursuant to the South Carolina Administrative Procedures Act.~~

#### ~~SECTION VIII. — PENALTIES~~

~~Violations of this regulation shall be punishable in accordance with Sections 44-1-150, 48-1-320, and 48-1-330, of the 1976 Code of Laws of South Carolina, as amended.~~

#### ~~SECTION IX. — SEVERABILITY CLAUSE~~



~~Should any section, paragraph, sentence, clause or phrase of this regulation be declared unconstitutional or invalid for any reason, the remainder of said regulation shall not be affected thereby. [Repealed].~~

~~61-56.2. Licensing Of Onsite Wastewater System Master Contractors.~~

## ~~CONTENTS~~

~~100. PURPOSE~~

~~200. DEFINITIONS~~

~~300. ELIGIBILITY~~

~~400. CONTINUING EDUCATION AND TRAINING~~

~~500. PRACTICE, PROCEDURE AND QUALITY CONTROL~~

~~600. BONDING AND INSURANCE REQUIREMENTS~~

~~700. APPLICATION AND LICENSE FEES~~

~~800. ENFORCEMENT~~

~~900. SEVERABILITY CLAUSE~~

~~100. PURPOSE~~

~~The purpose of this regulation is to protect public health and the environment by ensuring the competence of onsite wastewater system master contractors. Proper construction, installation and approval practices for onsite wastewater systems are essential for the safe treatment and disposal of domestic wastewater.~~

~~200. DEFINITIONS~~

~~ALTERNATIVE SYSTEM—A system incorporating design modifications of the proposed subsurface wastewater infiltration area (drainfield) or absorption trench geometry for the purpose of achieving compliance with required setbacks and offset to the zone of saturation and/or restrictive horizons. No such system shall be utilized unless the Department has established a specific standard.~~

~~ALTERNATIVE TILEFIELD PRODUCTS—Products specifically designed to replace or eliminate the aggregate typically utilized in soil absorption trenches. Such products must be approved for use by the Department and must adhere to required equivalency values established herein.~~

~~APPLICANT—A property owner, general contractor or agent representing the property owner, or a developer who seeks a permit to construct and operate an onsite wastewater system.~~

~~BOND—A sum of money set aside (Surety Bond) to insure completion of work under a contract.~~

~~CONVENTIONAL SYSTEM—An onsite wastewater system that utilizes a network of conventional absorption trenches installed in the naturally occurring soil for the treatment and disposal of domestic wastewater.~~

~~CONSTRUCT—The installation or repair of an onsite sewage treatment and disposal system.~~

~~DEPARTMENT—The South Carolina Department of Health and Environmental Control (DHEC).~~

~~DOMESTIC WASTEWATER—The untreated liquid and solid human body waste and the liquids generated by water using fixtures and appliances, including those associated with food service operations. For the purposes of this regulation, domestic wastewater shall not include industrial process wastewater.~~

~~EFFLUENT—The liquid discharged from a septic tank, effluent pump station, or other sewage treatment device.~~

~~EXISTING SYSTEM—An onsite wastewater system, which has received final construction approval or has been serving a legally occupied residence or structure.~~

~~FAILING ONSITE WASTEWATER SYSTEM—An onsite wastewater system that is discharging effluent in an improper manner or has ceased to function properly.~~

~~LICENSE—The official document issued by the Department authorizing a person to provide services for installation, repair, modification or final inspection and approval of onsite wastewater systems that they install.~~

~~LICENSED SEPTIC TANK CONTRACTOR—A person authorized under Regulation 61-56.1, License to Construct or Clean Onsite Sewage Treatment and Disposal Systems and Self-Contained Toilets, to construct, repair or clean onsite sewage disposal systems or self-contained toilets.~~

~~ONSITE WASTEWATER SYSTEM—A system, generally consisting of a collection sewer, septic tank(s), and soil absorption trenches (subsurface wastewater infiltration area), designed to treat and dispose of domestic wastewater through a combination of natural processes that ultimately result in effluent being transmitted through the soil, renovated, and ultimately discharged to groundwater.~~

~~ONSITE WASTEWATER SYSTEM MASTER CONTRACTOR—A person authorized under this regulation to construct, repair, modify, inspect and issue final construction approval for onsite wastewater systems that they install.~~

~~PERMIT—A written document issued by the Department authorizing the construction and operation of an onsite wastewater system under Regulation 61-56. The construction and operation permit survives the life of the onsite wastewater system that it authorizes.~~

~~REPAIR—Any work performed on an existing onsite wastewater system for the purposes of correcting a surface failure or other unauthorized discharge, enhancing system performance, or relocating the entire system or system components, provided there are no changes in use that would impact the existing system.~~

~~REVOCAION—The permanent withdrawal of rights and privileges granted by a license.~~

~~SEPTIC TANK—A watertight, covered receptacle designed and constructed to receive the discharge of domestic wastewater from a building sewer, separate solids from the liquid, digest organic matter, store digested solids through a period of detention and biological conditioning of liquid waste, and allow the effluent to discharge for final treatment and disposal.~~

~~SOIL ABSORPTION TRENCH—A trench installed in the naturally occurring soil that is utilized for the treatment and disposal of domestic wastewater. A conventional trench is characterized by the following: (a) at least twenty-three (23) inches in depth; (b) thirty-six (36) inches in width; (c) filled with aggregate so that at least six (6) inches is beneath the distribution pipe, with at least five (5) inches on both sides of the pipe, and at least three (3) inches covering the pipe; and (d) at least nine (9) inches of backfill. Other trench configurations are specified in Regulation 61-56 Appendices of Standards for Onsite Wastewater Systems.~~

~~STANDARD—A group of requirements developed by the Department that specifies the minimum site conditions and design criteria necessary for the approval of a specific type of onsite wastewater system (i.e., alternative system) that differs from a conventional system. A standard may also address minimum design~~

~~criteria for certain components of onsite wastewater systems as well as methodologies for determining system sizing.~~

~~SUBSURFACE WASTEWATER INFILTRATION AREA (DRAINFIELD) — A specific area where a network of soil absorption trenches or other devices of sewage application are installed to provide the final treatment and disposal of effluent.~~

~~SURETY AGREEMENT — Through this agreement, the surety agrees to uphold for the benefit of the obligee the contractual promises (obligations) made by the principal if the principal fails to uphold its promises to the obligee.~~

~~SUSPENSION — The temporary or indefinite withdrawal of rights and privileges granted by a license.~~

### ~~300. ELIGIBILITY~~

~~An onsite wastewater systems contractor currently licensed under R. 61.56.1, who meets the following criteria, is eligible to be licensed as an onsite wastewater systems master contractor:~~

- ~~— (1) a licensed onsite wastewater systems contractor who has been actively installing for three (3) years immediately preceding the date of application with no disciplinary action pending involving septic tank contracting; or~~
- ~~— (2) an onsite wastewater systems contractor licensee from another state with affidavits from the regulatory authority supporting five (5) years of experience with no pending disciplinary action involving septic tank contracting; and~~
- ~~— (3) the ability to pass an examination administered by the Department with a minimum score of eighty percent (80 %); and~~
- ~~— (4) a properly completed application with supporting documents (if required); and~~
- ~~— (5) proof of required bond and insurance coverage; and~~
- ~~— (6) payment of applicable fees.~~

### ~~400. CONTINUING EDUCATION AND TRAINING~~

~~400.1. The master contractor will be required to complete six (6) contact hours of training and continuing education every year from the date of licensing to renew the master contractor license. The Department will provide a listing of approved training providers and courses to meet this requirement.~~

~~400.2. The master contractor who fails to meet the training and continuing education requirements will lose the rights and privileges granted under that license until such time as these requirements have been met.~~

~~400.3. If the master contractor fails to meet the training and education requirement within the next licensing period, the license will be considered void.~~

~~400.4. If a master contractor completes more than the required six (6) hours in a licensing period, as many as three (3) hours can be rolled over into the requirement for the next licensing period.~~

## ~~500. PRACTICE, PROCEDURE AND QUALITY CONTROL~~

### ~~500.1. Practice~~

- ~~—(1) Onsite wastewater systems installed and approved by master contractors must be installed pursuant to, and in compliance with, construction and operation permits issued by the Department.~~
- ~~—(2) The master contractor does not have the authority to change an issued permit without first obtaining Department approval.~~
- ~~—(3) A master contractor authorized under this regulation will be able to install, inspect and approve any system permitted by the Department under Regulation 61-56 that the master contractor installs himself— except those systems designed by a Licensed Professional Engineer.~~
- ~~—(4) The master contractor, after giving the Department the opportunity to do a final inspection of the installed system, may record and document the necessary measurements on a form approved by the Department, issue final approval, and cover the installation.~~
- ~~—(5) The as built drawings, along with the master contractor's signature and license number, must be submitted to the Department, with a copy being provided to the property owner for whom the system was installed.~~

### ~~500.2. Procedure~~

- ~~—(1) The master contractor shall arrange a time, for the final inspection of an onsite wastewater system that is being installed, with a representative of the Department. If, after thirty (30) minutes of that arranged time, the Department representative has not arrived for the inspection, the master contractor may:
  - ~~—(a) inspect the system;~~
  - ~~—(b) record the findings on a form approved by the Department;~~
  - ~~—(c) grant final construction approval to the installation; and~~
  - ~~—(d) cover the system.~~~~
- ~~—(2) The as built drawings containing the required measurements and other documentation shall be submitted to the Department no later than the close of business on the next business day. A copy of this document(s) must also be furnished to the property owner for whom the system was installed.~~

### ~~500.3. Quality Control~~

~~The Department is required to conduct random final inspections on no less than three percent (3%) annually of the total number of systems installed during the preceding fiscal year. The Department will also conduct field reviews of the as built drawings submitted by the master contractor compared with the actual installations those drawings represent.~~

## ~~600. BONDING AND INSURANCE REQUIREMENTS~~

~~600.1. Proof of both insurance and bond coverage shall be furnished to the Department prior to licensure as a master contractor and upon annual license renewal.~~

~~600.2. The onsite wastewater system master contractor shall be responsible for obtaining and maintaining both insurance and bond coverage for as long as the contractor is operating as a master contractor.~~

~~600.3. Failure to maintain both insurance and bond coverage shall result in the suspension or revocation of the master contractor license.~~

#### ~~700. APPLICATION AND LICENSE FEES~~

~~700.1. The application fee for an onsite wastewater systems master contractor license shall be seventy five dollars (\$75.00); this fee must be submitted with the completed application. The application fee is non-refundable.~~

~~700.2. Upon successful completion of the application and examination requirements, each licensee shall pay a licensing fee of two hundred dollars (\$200.00).~~

~~700.3. The annual renewal fee for each license shall be two hundred dollars (\$200.00).~~

~~700.4. Failure to pay the annual renewal fee shall result in the suspension or revocation of the master contractor license.~~

~~700.5. Licenses issued in accordance with this regulation shall not be transferable.~~

#### ~~800. ENFORCEMENT~~

~~800.1. Deviation from the installation design and conditions in onsite wastewater permits may be considered a violation of this regulation.~~

~~800.2. Violation of an onsite wastewater system installation permit, or any provisions of this regulation, by a master contractor, must be enforced in accordance as follows:~~

~~— (1) First offense violations may be enforced under S.C. Code Section 44-1-150 or by suspension of the installer's license for a period not to exceed one (1) year.~~

~~— (2) Second offense violations may be enforced under S.C. Code Section 44-1-150 or by suspension of the installer's license for a period not to exceed three (3) years.~~

~~— (3) Third offense violations may be enforced under S.C. Code Section 44-1-150 or by permanent revocation of the installer's license.~~

~~800.3. A Department decision involving the issuance, denial, renewal, modification, suspension, or revocation of a permit or license may be appealed by an affected person with standing pursuant to applicable law, including S.C. Code Title 44, Chapter 1 and Title 1, Chapter 23.~~

#### ~~900. SEVERABILITY CLAUSE~~

~~This regulation is issued under the authority of Sections 44-1-140(11), 44-1-150, 44-55-827, and 48-110 et seq. of the 1976 Code of Laws, as amended. It shall be enforced in accordance with interpretations and public health reasons approved by the Department. Should any section, paragraph, sentence, clause or phrase of this regulation be declared unconstitutional or invalid for any reason, the remainder of this regulation shall not be affected thereby. [Repealed].~~

## **ATTACHMENT B**

### **DEPARTMENT OF HEALTH AND ENVIRONMENTAL CONTROL**

#### **CHAPTER 61**

**Statutory Authority: 1976 Code Sections 44-1-140(11), 44-1-150, 44-55-827, and 48-**

#### **Notice of Drafting:**

The South Carolina Department of Health and Environmental Control (“Department”) proposes amending Regulation 61-56, Onsite Wastewater Systems. The Department further proposes amending requirements of Regulation 61-55, Septic Tank Site Evaluation Fees, and merging R.61-55 into R.61-56. This will entail repealing R.61-55 and adding its provisions, as amended, to R.61-56. The Department also proposes amending requirements of Regulation 61-56.1, License to Construct or Clean Onsite Sewage Treatment and Disposal Systems and Self-Contained Toilets, and Regulation 61-56.2, Licensing of Onsite Wastewater Master Contractors, and merging R.61-56.1 and R.61-56.2 into R.61-56. This will entail repealing R.61-56.1 and R.61-56.2 and adding their provisions, as amended, to R.61-56.

Interested persons are invited to submit written comments to David Vaughan, Division Director, Division of Onsite Wastewater Management, Rabies Prevention, and Enforcement, S.C. Department of Health and Environmental Control, 2600 Bull Street, Columbia, S.C. 29201 or via email at [vaughadr@dhec.sc.gov](mailto:vaughadr@dhec.sc.gov). To be considered, comments must be received no later than 5:00 p.m. on May 28, 2018, the close of the drafting comment period.

#### **Synopsis:**

The Department proposes amending Regulation 61-56, Onsite Wastewater Systems, to add new system standards, clarify and amend definitions, and clarify and update selected sections. The amendments will clarify and modernize the regulation to address needed updates in administering the Onsite Wastewater program.

The Department further proposes amending the fee schedule currently appearing in R.61-55 and, in the interest of efficiency, moving the amended fee scale to R.61-56. This will entail repealing R.61-55 and simultaneously adding its provisions, as amended, to R.61-56. The proposed amendments will include amended definitions, increase in fees, a new, expedited permitting process with associated fees, and assignment of application fees to specific performed services. These amendments would update fees to an appropriate level for implementing site evaluations for proposed individual sewage treatment and disposal systems.

The Department also proposes amending provisions of R.61-56.1 and R.61-56.2 and merging R.61-56.1 and R.61-56.2 into R.61-56 to improve efficiency and clarity for Department staff, regulated entities, and the public. This will entail repealing R.61-56.1 and R.61-56.2 and simultaneously adding their provisions, as amended, to R.61-56. The proposed amendments will include changes to licensing and fee requirements for pumpers and haulers currently under R.61-56.1. The proposed amendments also will revise provisions currently contained in R.61-56.2 to implement a tiered licensing program to establish improved competency of onsite wastewater system contractors/installers. This approach includes new requirements for examination, continuing education, and an associated licensure fee.

The Department may also include stylistic changes for internal consistency, such as corrections for clarity in wording, references, grammar, outlining and codification, and such other changes as necessary to improve the overall quality of the regulation. Legislative review is required.



Mark Elam, Chairman  
David W. Gillespie, MD, Vice-Chairman  
Charles M. Joye II, P.E., Secretary

**Board:**  
Richard (Rick) Toomey, DHA, FACHE  
Seema Shrivastava-Patel  
Jim Creel, Jr.

## Meeting Dates for 2019\*

Thursday, January 3 (1<sup>st</sup> Thursday)  
Thursday, February 7 (1<sup>st</sup> Thursday)  
Thursday, March 7 (1<sup>st</sup> Thursday)  
Thursday, April 11  
Thursday, May 9  
Thursday, June 13  
Thursday, July 11  
Thursday, August 8  
Thursday, September 12  
Thursday, October 10  
Thursday, November 7 (1<sup>st</sup> Thursday)  
Thursday, December 12

\*Meetings are scheduled for 10:00 am in the Board Room of the S.C. Department of Health and Environmental Control. Dates, times or locations may change if necessary. Public notice will be given of any change in date, time or location. Meetings may be cancelled

Approved this 11<sup>th</sup> day of October 2018.

---

Mark Elam, Chairman  
S.C. Board of Health and Environmental Control