

FIGURE 2
 DOMINION ENERGY
 SOUTH CAROLINA, INC.

SITE RESTORATION PLAN

CONGAREE RIVER MRA
 COLUMBIA, SOUTH CAROLINA

DATE: 9/8/20 FILE NAME: CONG585

APEX COMPANIES, LLC

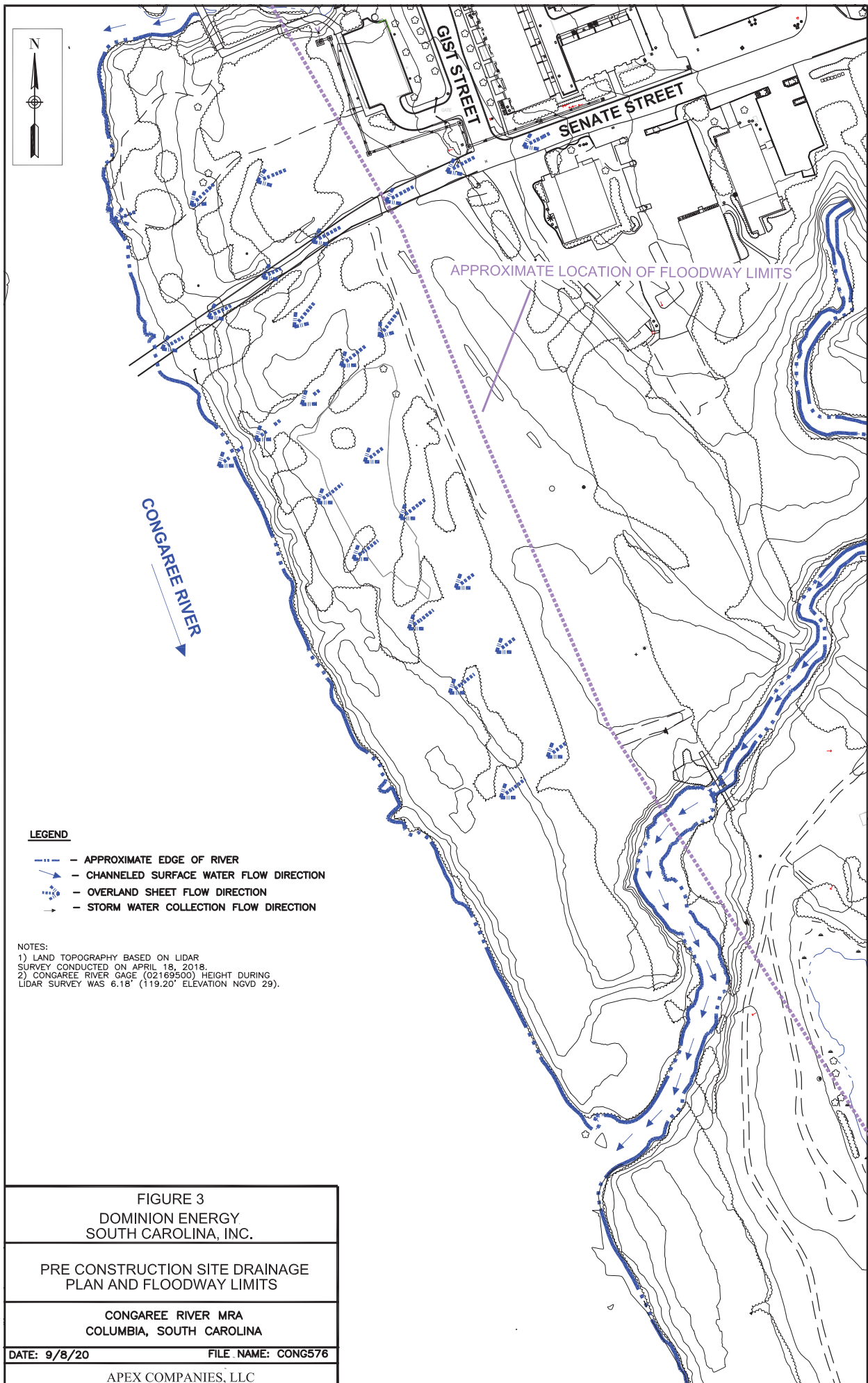

FIGURE 3
DOMINION ENERGY
SOUTH CAROLINA, INC.

PRE CONSTRUCTION SITE DRAINAGE
PLAN AND FLOODWAY LIMITS

CONGAREE RIVER MRA
COLUMBIA, SOUTH CAROLINA

DATE: 9/8/20

FILE NAME: CONG576

APEX COMPANIES, LLC

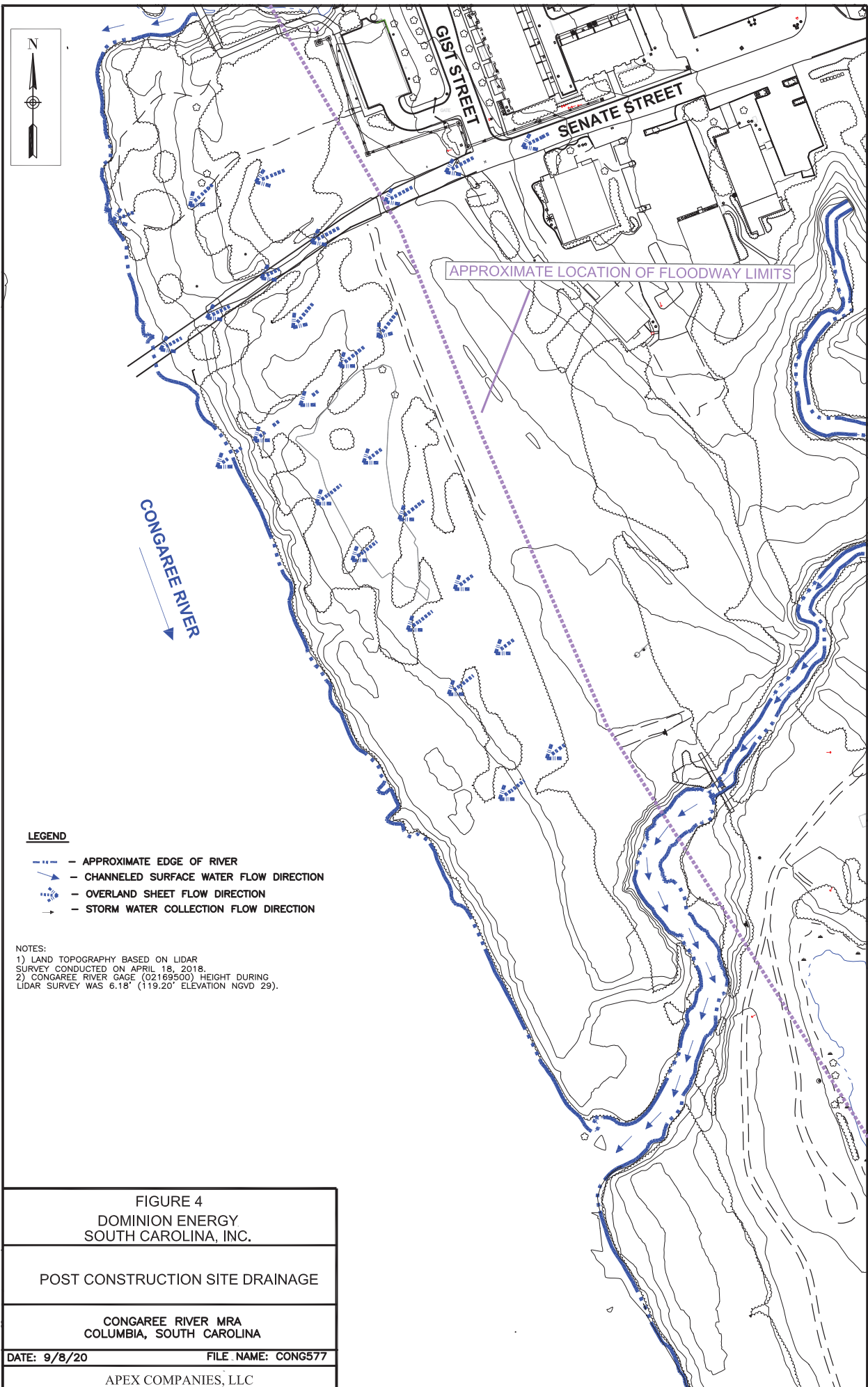

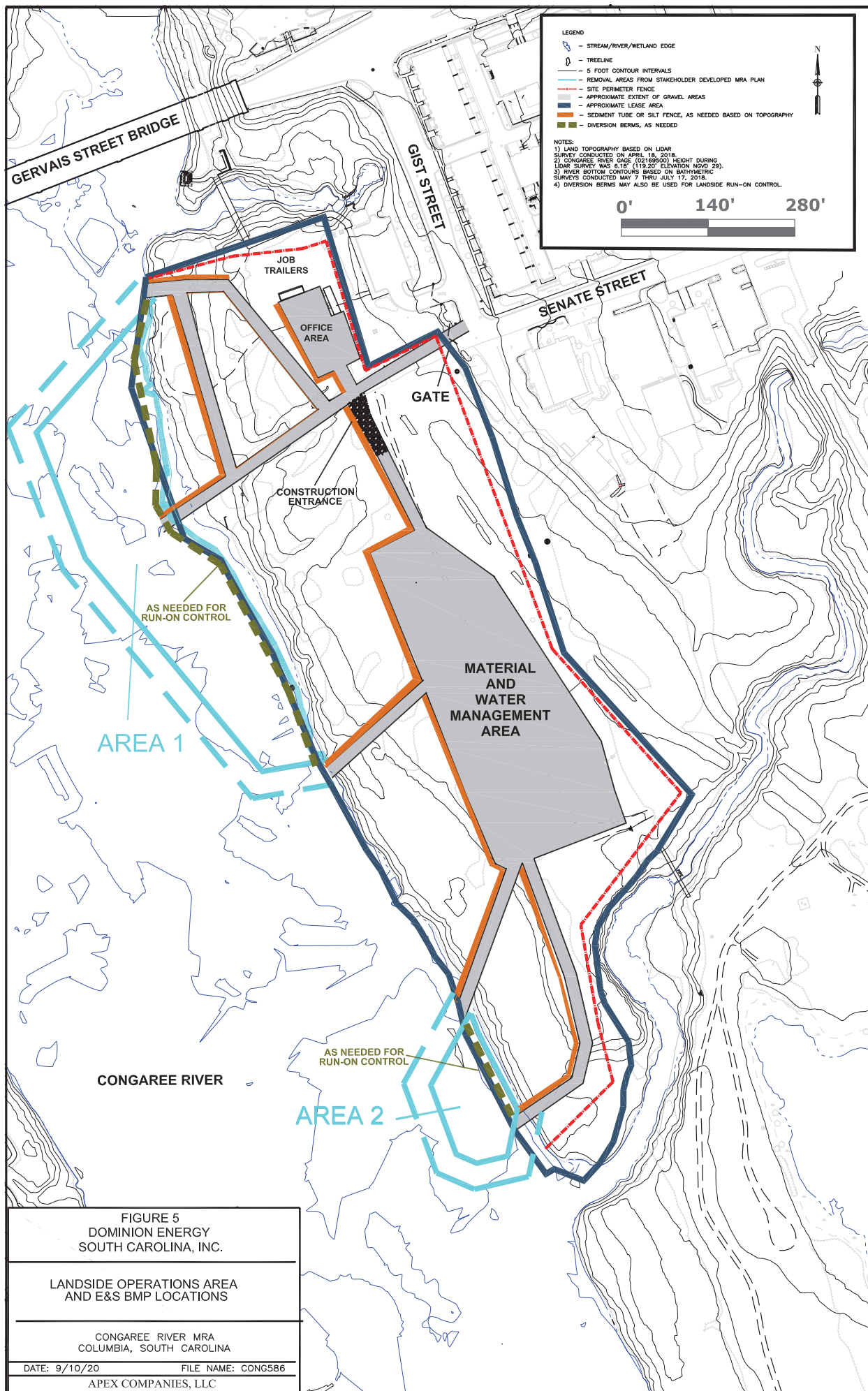

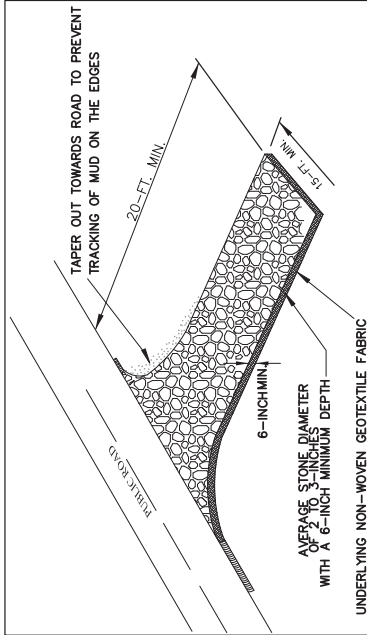

INSTALL A CULVERT PIPE ACROSS THE ENTRANCE WHEN NEEDED TO PROVIDE POSITIVE DRAINAGE.

DIVERT ALL SURFACE RUNOFF AND DRAINAGE FROM THE STONE PAD TO A SEDIMENT TRAP OR BASIN OR OTHER SEDIMENT TRAPPING STRUCTURE.

SPECIFICATION	SIZE
ROCK PAD THICKNESS	6 INCHES
ROCK PAD WIDTH	15 FEET
ROCK PAD LENGTH	20 FEET
ROCK PAD STONE SIZE	D50 = 2-3 INCHES

STABILIZED CONSTRUCTION ENTRANCE

STABILIZED CONSTRUCTION ENTRANCE
When and Where to Use It
 Stabilized construction entrances should be used at all points where traffic will be leaving a construction site and moving directly onto a public road.

Inspection and Maintenance
 If washing is used, provisions must be made to intercept the wash water and trap the sediment before it is discharged onto the public road. The drainage area must be established with crushed gravel and drain into a sediment trap or sediment basin. Construction entrances should be used in conjunction with the stabilization of construction roads to reduce the amount of mud picked up by vehicles.

Installation
 Remove all vegetation and any objectionable material from the foundation area.
 Divert all surface runoff and drainage from stones to a sediment trap or basin.
 Install a non-woven geotextile fabric prior to placing any stone.

Install a culvert pipe across the entrance when needed to provide positive drainage.
 The entrance shall consist of 2-inch to 3-inch D50 stone placed at a minimum depth of 6-inches. Minimum dimensions of the entrance shall be 15-feet wide by 20-feet long, and may be modified as necessary to accommodate site constraints.
 The edges of the entrance shall be tapered out towards the road to prevent tracking of mud at the edge of the entrance.

Inspection and Maintenance
 Inspect construction entrances every seven (7) calendar days and within 24-hours after each rainfall event that produces 1/2-inch or more of precipitation, or after heavy use. Check for mud and sediment buildup and pad integrity. Make daily inspections during periods of wet weather. Maintenance is required more frequently in wet weather conditions. Reshape the stone pad as needed for drainage and runoff control. Wash or replace stones as needed and as directed by the inspector. The stone in the entrance should be washed or replaced whenever the entrance fails to reduce mud being carried off-site by vehicles. Frequent washing will extend the useful life of stone.
 Immediately remove mud and sediment tracked or washed onto public roads by brushing or sweeping. Flushing should only be used when the water can be discharged to a sediment trap or basin.
 Repair any broken pavement immediately.

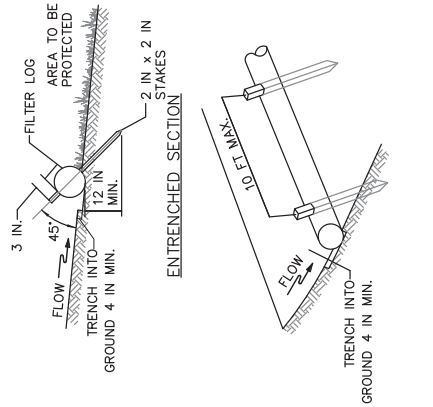
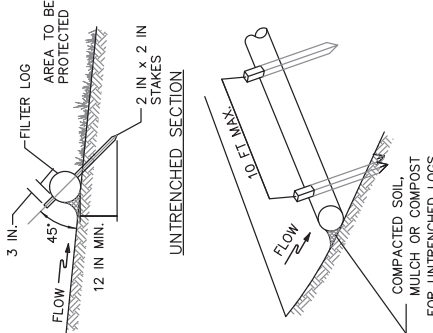
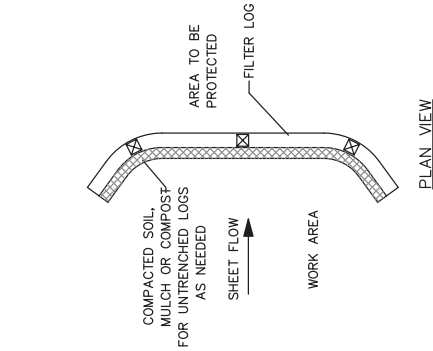

OR

ENTRENCHED INSTALLATION*

*THIS APPLICATION MAY NOT BE USED WITH LOGS SMALLER THAN 12 IN.

SEDIMENT TUBE / FILTER LOG INSTALLATION

CONSTRUCTION SPECIFICATIONS

- PRIOR TO INSTALLATION, CLEAR ALL OBSTRUCTIONS INCLUDING ROCKS, CLOGS, AND DEBRIS GREATER THAN ONE INCH THAT MAY INTERFERE WITH PROPER FUNCTION OF FILTER LOG.
- FILL LOG NETTING UNIFORMLY WITH COMPOST OR OTHER APPROVED BIODEGRADABLE MATERIAL TO DESIRED LENGTH SUCH THAT LOGS DO NOT DEFORM.
- INSTALL FILTER LOGS PERPENDICULAR TO THE FLOW DIRECTION AND PARALLEL TO THE SLOPE WITH THE BEGINNING AND END OF THE INSTALLATION POINTING SLIGHTLY UP THE SLOPE CREATING A "J" SHAPE AT EACH END TO PREVENT BYPASS.
- FOR UNTRENCHED INSTALLATION, BLOW OR HAND PLACE MATERIAL ON UPHILL SIDE OF THE SLOPE ALONG LOG AS NEEDED TO PREVENT UNDERCUTTING, AND STAKE EVERY 10 FEET OR CLOSER.
- FOR ENTRENCHED INSTALLATION, TRENCH LOG INTO GROUND A MINIMUM OF 4 INCHES AND STAKE LOG EVERY 10 FEET OR CLOSER.
- USE STAKES WITH A MINIMUM NOMINAL CROSS SECTION OF 2X2 INCH AND OF SUFFICIENT LENGTH TO ATTAIN A MINIMUM OF 12 INCHES INTO THE GROUND AND 3 INCHES PROTRUDING ABOVE LOG.
- WHEN MORE THAN ONE LOG IS NEEDED, OVERLAP ENDS 12 INCHES MINIMUM AND STAKE.
- REMOVE SEDIMENT WHEN IT HAS ACCUMULATED TO A DEPTH OF 1/2 THE EXPOSED HEIGHT OF LOG AND REPLACE MULCH. REPLACE FILTER LOG IF TORN. REINSTALL FILTER LOG IF UNDERMINING OR DISLOCATING OCCURS. REPLACE CLOGGED FILTER LOGS.

ACCESS GRAVEL ROAD DETAIL

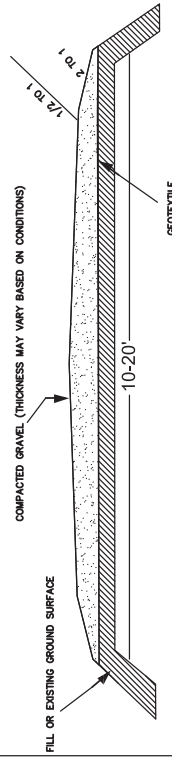

FIGURE 6A
 DOMINION ENERGY SOUTH CAROLINA, INC.

E&S CONTROL DETAILS

CONGAREE RIVER MRA
 COLUMBIA, SOUTH CAROLINA

DATE: 9/10/20

FILE NAME: CONGS66

APEX COMPANIES, LLC

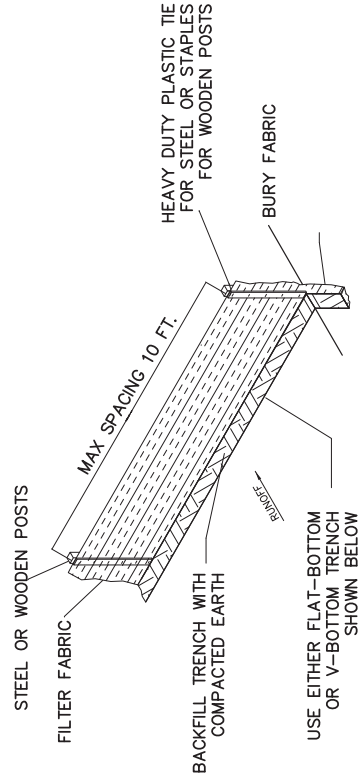

SILT FENCE INSTALLATION

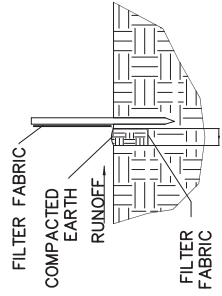

FLAT-BOTTOM TRENCH DETAIL

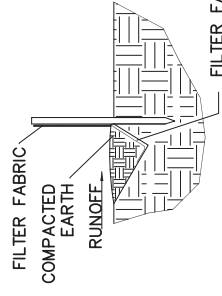

V-SHAPED TRENCH DETAIL

SILT FENCE DETAIL

When and Where to Use It
 Silt fence is applicable in areas:
 Where the maximum sheet or overland flow path length to the fence is 100-feet.
 Where the maximum slope steepness (normal [perpendicular] to fence line) is 2H:1V.
 That do not receive concentrated flows greater than 0.5 cfs.
 Do not place silt fence across channels or use it as a velocity control BMP.

Materials
 Geotextile Filter Fabric
 Filter fabric is:
 Composed of fibers consisting of long chain synthetic polymers composed of at least 85% by weight of polyolefins, polyesters, or polyamides.
 Formed into a network such that the filaments or yarns retain dimensional stability relative to each other.
 Free of any treatment or coating which might adversely affect its physical properties after installation. Free of defects or flaws that significantly affect its physical and/or filtering properties.
 Use only fabric appearing on SCOOT Approval Sheet #24 meeting the requirements of the most current edition of the SCOOT Standard Specifications for Highway Construction.
 Posts
 Posts used for installation of the filter fabric shall be of wood or steel composition and meet industry standards.

SILT FENCE DETAIL (CONTINUED)

Installation (Typical)
 Excavate a trench approximately 6-inches wide and 6-inches deep when placing fabric by hand. Place 12-inches of geotextile fabric into the 6-inch deep trench, extending the remaining 6-inches toward the upslope side of the trench. Backfill the trench with soil or gravel and compact.
 Bury 12-inches of fabric into the ground when pneumatically installing silt fence with a slicing method.
 Purchase fabric in continuous rolls and cut to the length of the barrier to avoid joints. When joints are necessary, wrapped the fabric together at a support post with both ends fastened to the post, with a 6-inch minimum overlap.
 Install posts to a minimum depth of 24-inches. Install posts a minimum of 1- to 2-inches above the fabric, with no more than 3-feet of the post above the ground. Space posts to maximum 10-foot centers.
 Attach fabric to wood posts using staples inside of heavy-duty wire at least 1 1/2-inch long, spaced a maximum of 6-inches apart. Staple a 2-inch wide lath over the filter fabric to securely fasten it to the upslope side of the fabric. In call cases, ties should be affixed in no less than 4 places.
 Install the fabric the minimum specified distance above the ground. When necessary, the height of the fence above ground may be greater than the minimum. In tidal areas, extra silt fence height may be required. Locate silt fence checks every 100 feet maximum and at low points. Install the fence perpendicular to the direction of flow and place the fence the proper distance from the toe of steep slopes to provide sediment storage and access for maintenance and cleanout.
Inspection and Maintenance
 Inspect every seven calendar days and within 24-hours after each rainfall event that produces 1/2-inches or more of precipitation. Check for sediment buildup and fence integrity. Check where runoff has eroded a channel beneath the fence, or where the fence has sagged or collapsed by fence overlapping. If the fence fabric tears, begins to decompose, or in any way becomes ineffective, replace the section of fence immediately.
 Remove trapped sediment from the site or stabilize it on site.
 Remove silt fence within 30 days after final stabilization is achieved or after temporary best management practices (BMPs) are no longer needed. Permanently stabilize disturbed areas resulting from fence removal.

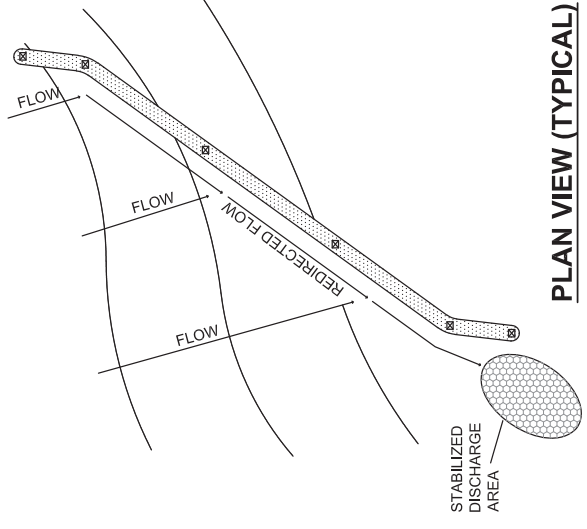

PLAN VIEW (TYPICAL)

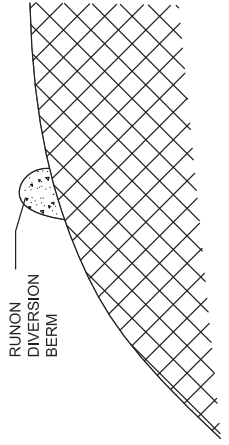

SECTION VIEW (TYPICAL)

RUNON DIVERSION BERM

- NOTES.**
1. Diversion berms shall be placed, maintained and adjusted as needed to control excess run-on from stormwater drainage.
 2. Berms shall be composed of compost filter socks designed for runoff diversion (e.g., FILTREXX SILTSOXX), compacted soil, sandbags, plastic piping or other suitable material.
 3. Runoff shall be directed to suitably stabilized areas or conveyance systems to prevent erosion.

FIGURE 6B

DOMINION ENERGY SOUTH CAROLINA, INC.	
E&S CONTROL DETAILS	
CONGAREE RIVER MRA COLUMBIA, SOUTH CAROLINA	
DATE: 9/10/20	FILE NAME: CONGS57
APEX COMPANIES, LLC	

TYPICAL CLEAN MATERIAL TEMPORARY STOCKPILE AREA

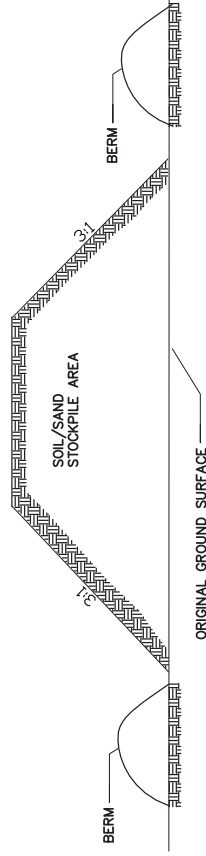

NOTES:

1. BERM TO EXTEND AROUND ENTIRE PERIMETER OF STOCKPILE, OR IF STOCKPILE AREA IS LOCATED ON/NEAR A SLOPE THE BERM IS TO EXTEND ALONG CONTOURS OF THE DOWN-GRADE AREA.
2. BERMS MAY BE CONSTRUCTED USING UNIMPACTED MATERIAL (NATIVE OR IMPORTED), PLASTIC PIPES, LUMBER, SAND BAGS OR OTHER SUITABLE MATERIAL, DEPENDING ON THE SIZE OF THE STAGING AREA.
3. BERM SHALL BE MAINTAINED UNTIL STOCKPILE AREA HAS EITHER BEEN REMOVED OR PERMANENTLY STABILIZED.
4. THE KEY TO FUNCTIONAL TEMPORARY STOCKPILE AREAS IS WEEKLY INSPECTIONS, ROUTINE MAINTENANCE, AND REGULAR SEDIMENT REMOVAL.

TYPICAL IMPACTED MATERIAL TEMPORARY STOCKPILE AREA

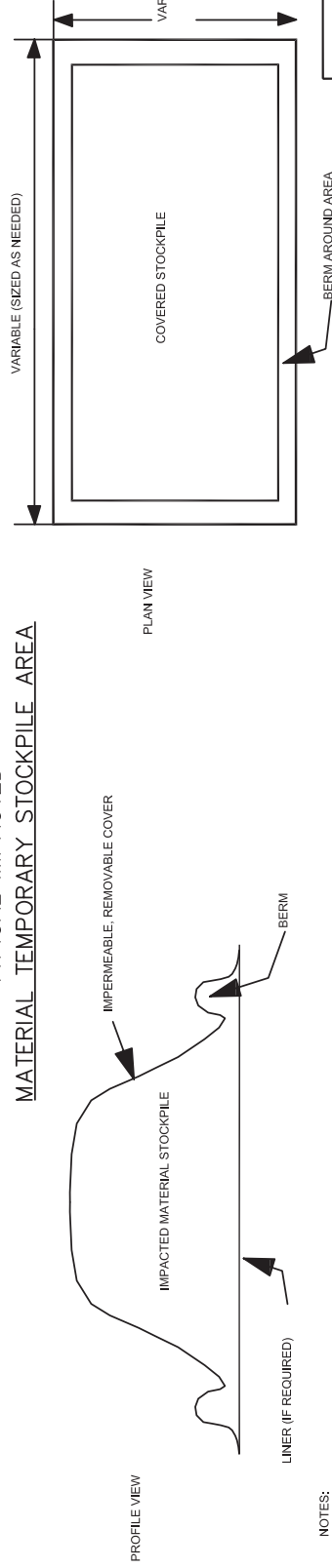

NOTES:

1. TO THE EXTENT POSSIBLE, USE OF TEMPORARY STOCKPILES ON UNDISTURBED AREAS FOR IMPACTED MATERIAL SHOULD BE AVOIDED.
2. TEMPORARY STOCKPILES ON EXISTING GRADE MUST INCLUDE A BERM AND COVER TO CONTROL POTENTIAL MIGRATION OF IMPACTED MATERIAL.
3. STOCKPILES PLACED ON UNIMPACTED SURFACES THAT WILL NOT BE SUBSEQUENTLY EXCAVATED MUST INCLUDE A LINER (E.G., PLASTIC SHEETING) WITH PROPER GRADING OF THE SURFACE TO PROTECT THE LINER INTEGRITY.
4. COVERS MUST BE USED AT THE END OF EACH WORKDAY OR AS WEATHER CONDITIONS WARRANT TO PREVENT PRECIPITATION RUNOFF FROM THE IMPACTED MATERIAL. COVERS MUST BE SECURED AS NECESSARY, AND CONSIST OF A REMOVABLE, IMPERMEABLE MATERIAL (E.G., PLASTIC SHEETING).
5. BERMS MAY BE CONSTRUCTED USING UNIMPACTED MATERIAL (NATIVE OR IMPORTED), PLASTIC PIPES, LUMBER, SAND BAGS OR OTHER SUITABLE MATERIAL DEPENDING ON THE SIZE OF THE STAGING AREA.
6. INSPECTION AND MAINTENANCE OF TEMPORARY IMPACTED MATERIAL STOCKPILES IS REQUIRED THROUGHOUT THE PROJECT.

FIGURE 6C

DOMINION ENERGY SOUTH CAROLINA, INC.

E&S CONTROL DETAILS

CONGAREE RIVER MRA
COLUMBIA, SOUTH CAROLINA

DATE: 8/18/20

FILE NAME: CONG568

APEX COMPANIES, LLC

SEEDING SCHEDULE

1. All excavated areas will be seeded using a perennial and nurse crop mix within 14 days of construction activities ceasing.
2. Establishing a stand of perennial grasses is critical to controlling runoff and erosion of areas disturbed by construction and maintenance activities. Once the permanent grasses begin to establish underneath the nurse crop, a mowing may be required to prevent shading and to release them.
3. Seeding application rates and time frames are listed below.
4. If construction activities must temporarily cease for 14 days or more, then seeding must be initiated. If temporary seeding is required, apply only the nurse crops listed below at double the below listed application rates.

SEEDING PROCEDURES

1. Sub-soil/chisel plow/disk disturbed areas, as necessary
2. Apply lime, as necessary (based on soil sample) (2,000 lb./acre if soil sample not taken)
3. Disk in lime to incorporate into the soil
4. Apply seed based on application rates below (permanent grass and nurse crop mix)
5. Acquire a firm seed bed by rolling with cultipacker or equivalent
6. Apply hay straw at approximately 2,000 lb./acre and crimp into soil or hydramulch at approximately 1,200 lbs/acre
7. Once seed germinates, apply fertilizer as necessary (based on soil sample)

(Hydroseeding with the appropriate rates of lime, mulch, fertilizer, and seed may be applied if a well established seed bed is present (i.e. uncompacted and loosely disked soils)

Permanent Seeding Application Rates

Common Name of Seed / Planting Rate (pounds per acre) / Planting Dates

- Warm Season (Spring and Summer)
 - Hulled Common Bermuda / 25 / March – August
 - Browntop Millet (nurse crop) / 20 / Mid March – September
- Cool Season (Fall and Winter)
 - Unhulled Common Bermuda/ 30 / September – February
 - Annual Rye or Rye Grain (no rye grass) (nurse crop)/ 25 / October – Mid March

NOTE:

For significant slopes greater than 5 feet in height, add 10 lb./acre of Weeping Lovegrass and 50 lb./acre of sericea lespedeza to above rates.

For applications in the upper state (northwest of I-20 and US 1 (I-20 and US 1 meet in Columbia)) of SC, add 50 lb./acre of Kentucky 31 Fescue to above rates.

For wetland areas, only apply a light amount of nurse crop seed and no Bermuda or Kentucky 31 Fescue seed. Do not apply lime or fertilizer to wetland areas. These areas will rapidly revegetate in native wetland vegetation without seeding.

(deviations from these seed mixes allowed with prior approval)

TEMPORARY MULCHING DETAILS

1. Temporary mulching or seeding will be conducted in areas where construction activities may cease for 14 days or more.
2. See seeding schedule for temporary and permanent seeding details.
3. Mulch materials can include clean, weed free hay or straw, wood chips or wood fibers.
4. Hay/straw application rates are approximately 2,000 lb./acre. There must be adequate mulch coverage to prevent erosion, washout and poor plant establishment.
5. Grading is not necessary before mulching but may be required if vegetation is expected to grow.
6. Straw or hay must be anchored on the surface via application of a tackifier, stapling netting over top, or crimping with a mulch crimping tool. Materials heavy enough to stay in place in low slope areas, such as bark and wood fibers, do not need anchoring.
7. Mechanical crimping is preferred for slopes less than 3:1. For slopes greater than 3:1 erosion control mats, blankets or nets are recommended. If netting and matting material is used, firm continuous contact between the materials and the soil is required to prevent erosion.
8. Rock can also be used as mulch. An aggregate base course can be spread on disturbed areas for temporary or permanent stabilization. The rock mulch layer should be thick enough to provide full coverage of exposed soil on the area it is applied.
9. Mulched areas will be regularly inspected as part of the E&S inspection routine (minimum every 7 calendar days and after rainfall event that produces 1/2-inch or more of precipitation).
10. Damaged areas will be repaired or replaced as soon as practicable.

FIGURE 6D
DOMINION ENERGY
SOUTH CAROLINA, INC.

E&S CONTROL DETAILS

CONGAREE RIVER MRA
COLUMBIA, SOUTH CAROLINA

DATE: 9/10/20 FILE NAME: CONGS60

APEX COMPANIES, LLC

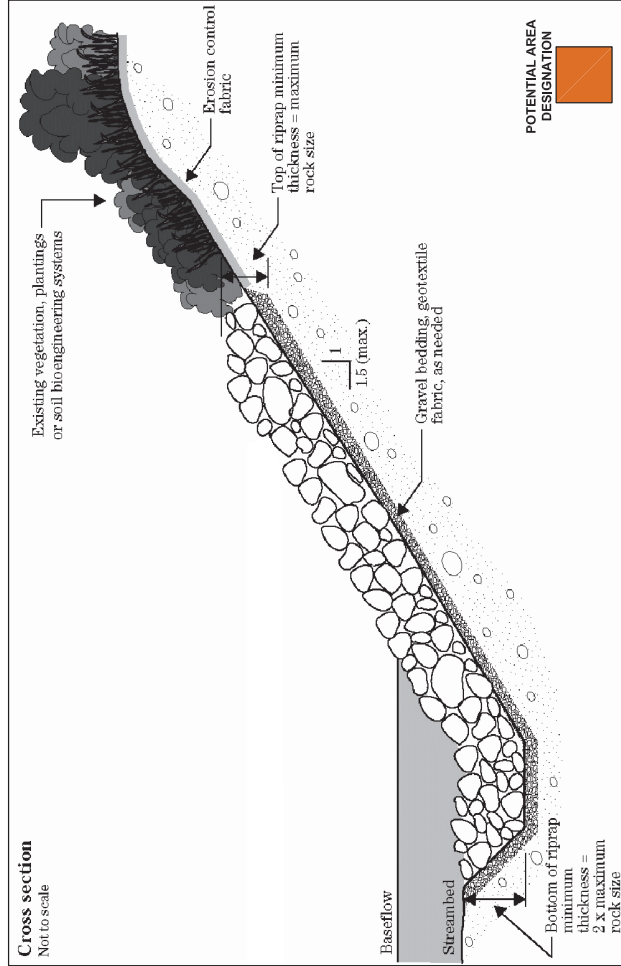

7A-1 TYPICAL RIPRAP RIVER BANK STABILIZATION
(OR OTHER HARDSCAPE MATERIAL)

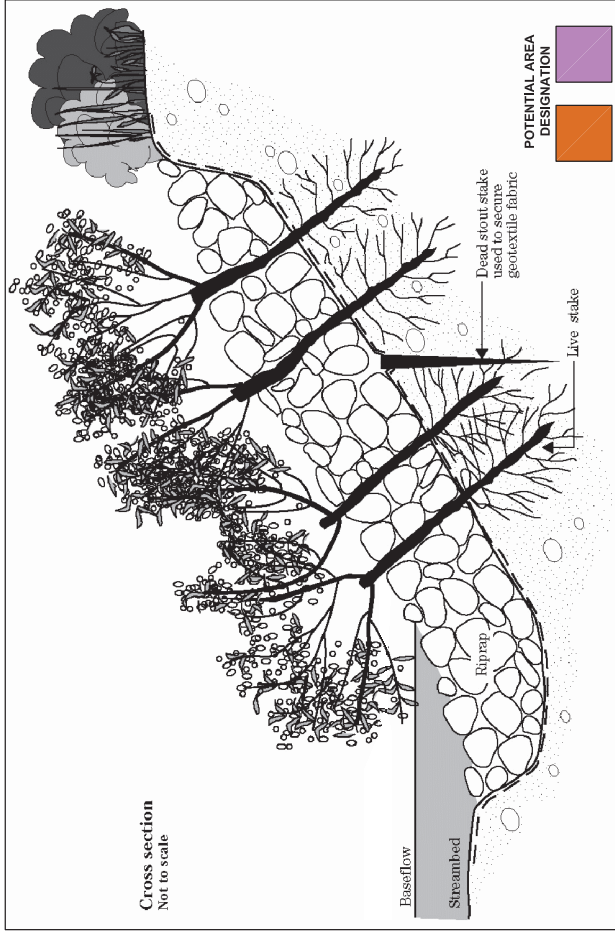

7A-2 TYPICAL RIPRAP RIVER BANK STABILIZATION WITH JOINT PLANTING
(OR OTHER HARDSCAPE MATERIAL)

NOTES:

1. RIPRAP BANK STABILIZATION WILL BE UTILIZED IN AREAS WITH HIGH VELOCITY AND OR TURBULENT RIVER FLOWS TO GUARD AGAINST FUTURE RIVERBANK EROSION.
2. JOINT PLANTING (DETAIL 7A-2) WILL BE CONDUCTED, IF FEASIBLE, TO PROVIDE VEGETATIVE COVER IN RIPRAP AREAS AND TO PROVIDE A TRANSITION TO OTHER BIOENGINEERED AREAS.
3. DETAILS OBTAINED FROM UNITED STATES DEPARTMENT OF AGRICULTURE NATURAL RESOURCES CONSERVATION SERVICE ENGINEERING FIELD HANDBOOK (ISSUED 1996) - PART 650 - CHAPTER 16 STREAMBANK AND SHORELINE PROTECTION.
4. INSTALLATION OF SHORELINE RESTORATION COMPONENTS WILL BE CONDUCTED IN ACCORDANCE WITH ESTABLISHED STANDARDS AS OUTLINE IN THE ABOVE REFERENCE ENGINEERING FIELD HANDBOOK.
5. TABLES 1, 2 AND 3 ON FIGURE 7D PROVIDE PLANT SPECIFICATIONS.

FIGURE 7A

DOMINION ENERGY
SOUTH CAROLINA, INC.

RIVERBANK STABILIZATION
DETAILS

CONGAREE RIVER MRA
COLUMBIA, SOUTH CAROLINA

DATE: 9/10/20 FILE NAME: CONG581

APEX COMPANIES, LLC

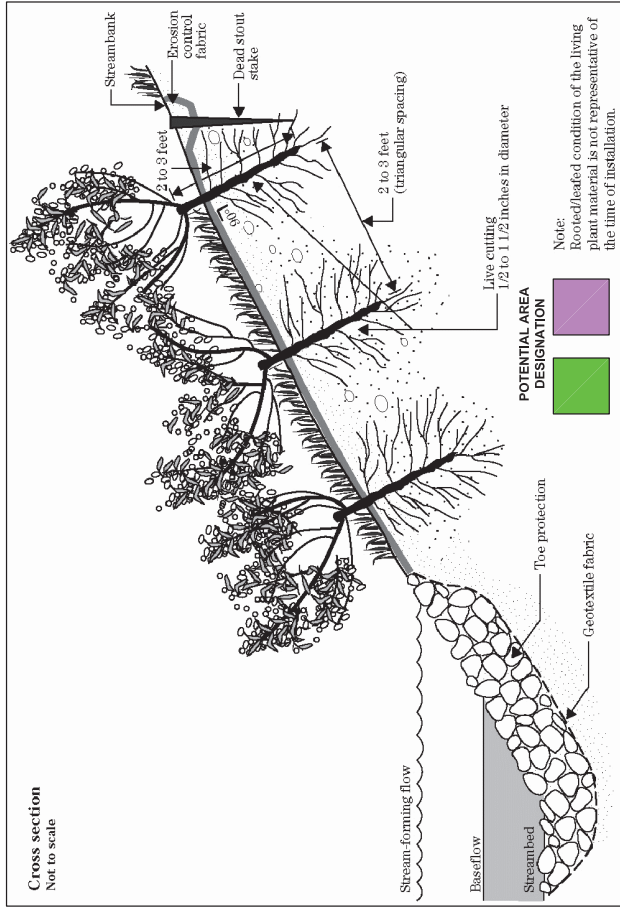
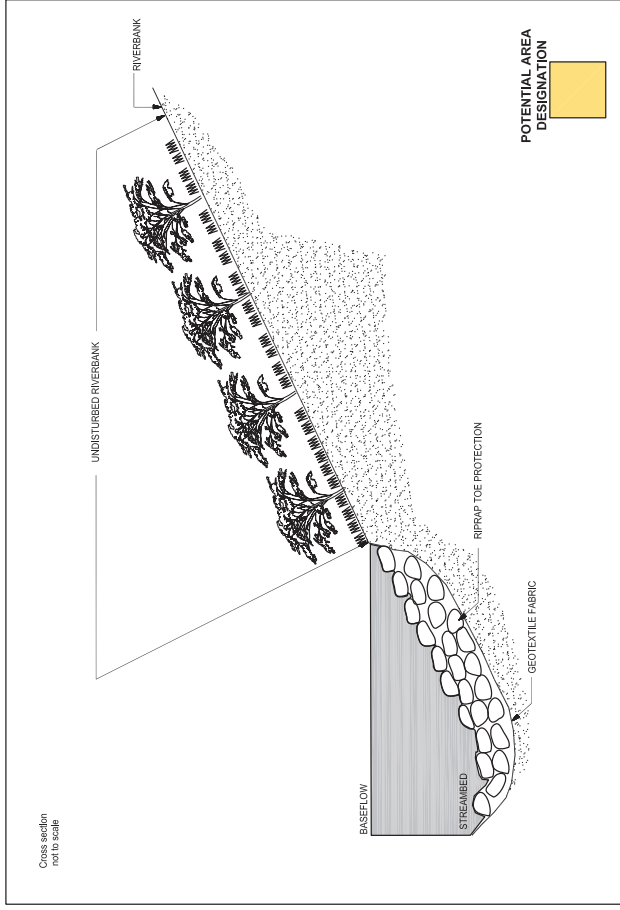

7B-1 UNDISTURBED RIVER BANK TOE STABILIZATION

7B-2 JOINT PLANTING BIOENGINEERED BANK STABILIZATION OPTION DETAIL

- NOTES:
1. GEOTEXTILE AND RIPRAP (DETAIL 7B-1) WILL BE UTILIZED TO STABILIZE EXCAVATED AREAS AT THE TOE OF RIVERBANK SLOPES TO PREVENT SLOUGHING OR COLLAPSING. RIPRAP PLACEMENT WILL TERMINATE AT OR BELOW THE APPROXIMATE NORMAL WATERLINE.
 2. LIVE STAKES (DETAIL 7B-2) WILL POTENTIALLY BE UTILIZED IN CONJUNCTION WITH OTHER BIOENGINEERED SOLUTIONS, AS NEEDED, IN AREAS WHERE RIVERBANK DISTURBANCE EXTENDS SIGNIFICANTLY ABOVE THE NORMAL WATERLINE AND RIVER FLOW VELOCITY AND TURBULENCE CONDITIONS DO NOT REQUIRE ADDITIONAL STABILIZATION MEASURES.
 3. DETAILS OBTAINED FROM UNITED STATES DEPARTMENT OF AGRICULTURE NATURAL RESOURCES CONSERVATION SERVICE ENGINEERING FIELD HANDBOOK (ISSUED 1996) - PART 650 - CHAPTER 16 STREAMBANK AND SHORELINE PROTECTION.
 4. INSTALLATION OF SHORELINE RESTORATION COMPONENTS WILL BE CONDUCTED IN ACCORDANCE WITH ESTABLISHED STANDARDS AS OUTLINE IN THE ABOVE REFERENCE ENGINEERING FIELD HANDBOOK.
 5. TABLES 1, 2 AND 3 ON FIGURE 7D PROVIDE PLANT SPECIFICATIONS.

FIGURE 7B DOMINION ENERGY SOUTH CAROLINA, INC.
RIVERBANK TOE STABILIZATION AND BIOENGINEERING OPTION DETAILS
CONGAREE RIVER MPA COLUMBIA, SOUTH CAROLINA
DATE: 9/10/20 FILE NAME: CONGS582 APEX COMPANIES, LLC

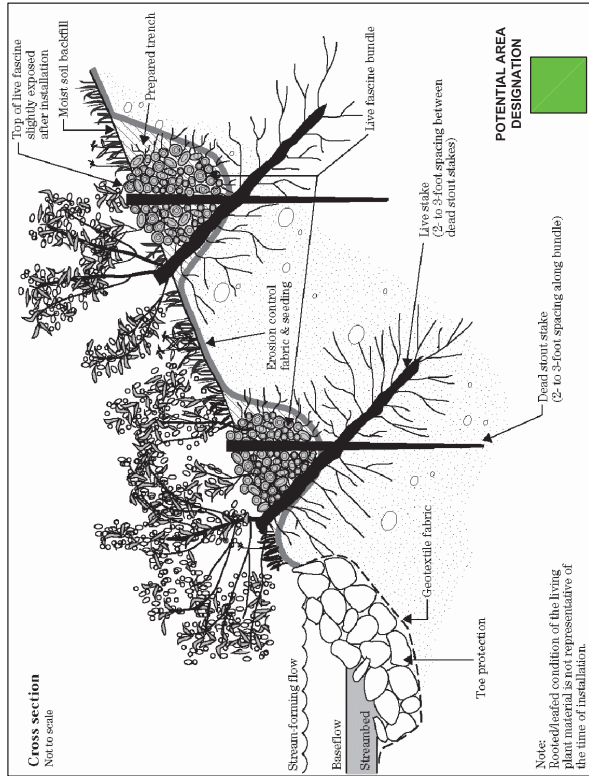

7C-1 LIVE FASCINE STABILIZATION OPTION

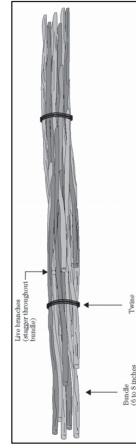

7C-2 LIVE FASCINE DETAIL

- NOTES:
1. LIVE FASCINES (DETAIL 7C-1) ARE AN OPTION FOR FLATTER SLOPE (3:1 OR FLATTER) STABILIZATION IN AREAS WHERE RIVER VELOCITY AND TURBULENCE CONDITIONS DO NOT REQUIRE ADDITIONAL STABILIZATION MEASURES.
 2. LIVE FASCINES (DETAIL 7C-2) ARE LONG BUNDLES OF BRANCH CUTTINGS THAT CONTAIN SOME LIVE BRANCHES.
 3. BRUSHMATTRESS (DETAIL 7C-3) PROVIDE A COMBINATION OF LIVE STAKES, LIVE FASCINES AND BRANCH CUTTINGS AND PROVIDE MORE PROTECTION FROM EROSION OF STEEPER SLOPES OR AREAS OF HIGHER VELOCITY RIVER FLOW.
 4. DETAILS OBTAINED FROM UNITED STATES DEPARTMENT OF AGRICULTURE NATURAL RESOURCES CONSERVATION SERVICE ENGINEERING FIELD HANDBOOK (ISSUED 1996) - PART 650 - CHAPTER 16 STREAMBANK AND SHORELINE PROTECTION.
 5. INSTALLATION OF SHORELINE RESTORATION COMPONENTS WILL BE CONDUCTED IN ACCORDANCE WITH ESTABLISHED STANDARDS AS OUTLINE IN THE ABOVE REFERENCE ENGINEERING FIELD HANDBOOK.
 6. TABLES 1, 2 AND 3 ON FIGURE 7D PROVIDE PLANT SPECIFICATIONS.

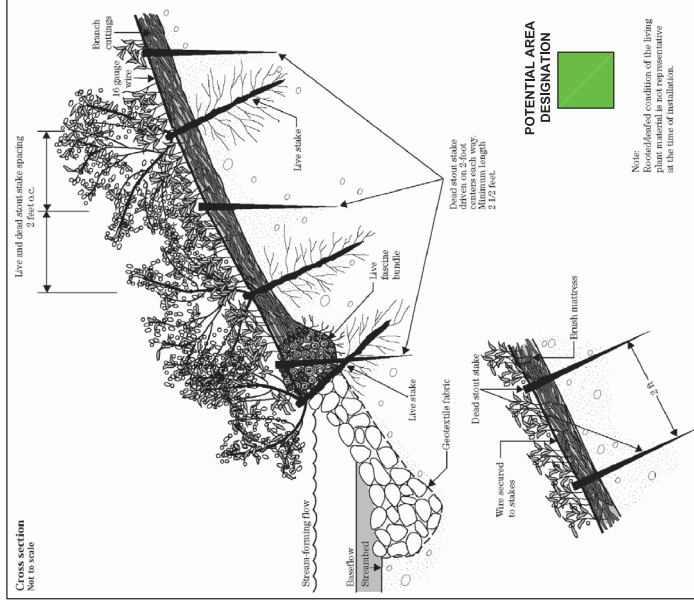

7C-3 BRUSHMATTRESS BANK STABILIZATION OPTION DETAIL

FIGURE 7C DOMINION ENERGY SOUTH CAROLINA, INC.
BIOENGINEERED STABILIZATION OPTION DETAILS
CONGAREE RIVER MRA COLUMBIA, SOUTH CAROLINA
DATE: 9/8/20 FILE NAME: CONG563 APEX COMPANIES, LLC

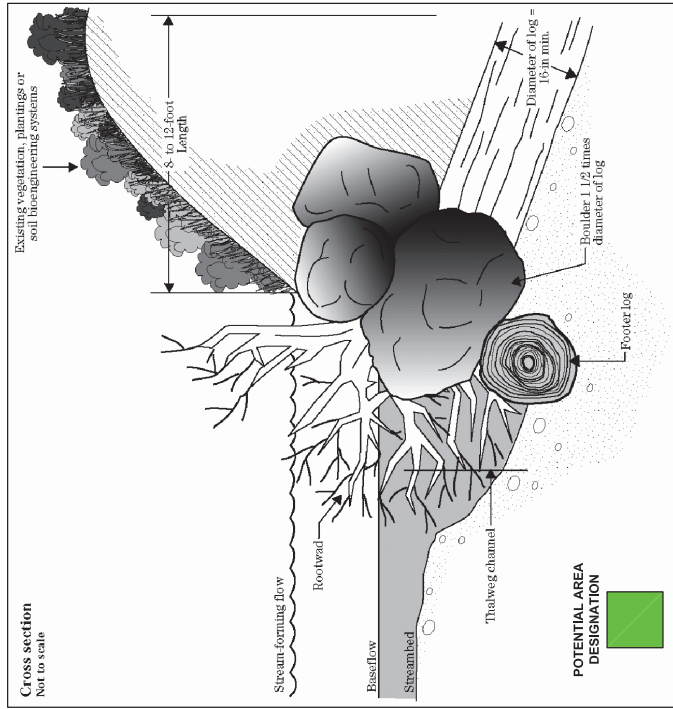

7D-1 LOG, ROOTWAD AND BOULDER REVETMENT STABILIZATION OPTION DETAIL

NOTES:

- LOG, ROOTWAD AND BOULDER REVETMENTS MAY BE UTILIZED SPORADICALLY TO PROVIDE OVERHEAD COVER AND HABITAT IMPROVEMENT ALONG THE DISTURBED SHORELINE.
- DETAILS OBTAINED FROM UNITED STATES DEPARTMENT OF AGRICULTURE NATURAL RESOURCES CONSERVATION SERVICE ENGINEERING FIELD HANDBOOK (ISSUED 1996) - PART 650 - CHAPTER 16 STREAMBANK AND SHORELINE PROTECTION.
- INSTALLATION OF SHORELINE RESTORATION COMPONENTS WILL BE CONDUCTED IN ACCORDANCE WITH ESTABLISHED STANDARDS AS OUTLINE IN THE ABOVE REFERENCE ENGINEERING FIELD HANDBOOK.
- PLANTING OPTIONS OBTAINED FROM THE "STREAMBANK AND SHORELINE STABILIZATION TECHNIQUES TO CONTROL EROSION AND PROTECT PROPERTY" - GEORGIA DEPARTMENT OF NATURAL RESOURCES.

TABLE 1
GRASSES AND FORBS

Scientific Name	Common Name	Soil Preference	Drought Tolerance	Shade Tolerance	Flood Tolerance
<i>Amorpha biqualis</i>	American beschnigrass	sands	fair	poor	poor
<i>Andropogon gerardi</i>	Big bluestem	loams	good	poor	fair
<i>Arnica montana</i>	Giant reed	sandy	poor	poor	poor
<i>Horafolia alissima</i>	Limpograss	sandy	poor	poor	poor
<i>Panicum amarulum</i>	Coastal panicgrass	sands to loams	good	poor	good
<i>Panicum virgatum</i>	Switchgrass	sands to loams	good	poor	good
<i>Paspalum vaginatum</i>	Shastore paspalum	sandy	poor	poor	poor
<i>Styrax mectra</i>	Prarie cordgrass	sands to loams	good	poor	poor
<i>Syntherisma mactra</i>	Giant cutgrass	loam	poor	poor	poor
<i>Zizaniopsis miliacea</i>					

TABLE 2
PLANTS SUITABLE FOR ROOTING

Scientific Name	Common Name	Plant Type	Rooting Ability (from cutting)
<i>Acer nigrande</i>	Boxelder	small tree	poor to fair
<i>Asimina triloba</i>	Pawpaw	medium shrub	good
<i>Baccharis balmifolia</i>	Groundsel bush	large shrub	fair to good
<i>Cephalanthus occidentalis</i>	Butterbush	small shrub	fair
<i>Comus amomum</i>	Silky dogwood	medium tree	poor to fair
<i>Comus sericea</i>	Red osier dogwood	tail tree	very good
<i>Gleditsia triacanthos</i>	Honeylocust	large shrub	very good
<i>Populus deltoides</i>	Eastern cottonwood	medium tree	good to excel
<i>Robinia sp.</i>	Black locust	small to large tree	good to excel
<i>Salix nigra</i>	Pussy willow	medium tree	excel
<i>Salix discolor</i>	Black willow	medium tree	good
<i>Salix purpurea</i>	Purpleosier willow	medium tree	good
<i>Sambucus canadensis</i>	American elder	medium to tall shrub	good
<i>Viburnum dentatum</i>	Aronwood	large shrub	fair to good
<i>Viburnum lentago</i>	Nannyberry	large shrub	fair to good

TABLE 3
WOODY PLANTS

Scientific Name	Common Name	Plant Type	Establishment Speed
<i>Acer nigrande</i>	Boxelder	small to medium tree	fast
<i>Acer rubrum</i>	Red maple	medium tree	fast
<i>Acer spicatum</i>	Spotted maple	large shrub	medium
<i>Alnus incana</i>	White alder	medium tree	fast
<i>Artemisia tridentata</i>	Red Chokeberry	shrub	fast
<i>Asimina triloba</i>	Pawpaw	small tree	fast
<i>Betula nigra</i>	River birch	medium to large tree	fast
<i>Caryna caroliniana</i>	American hornbeam	small tree	slow
<i>Carya cordiformis</i>	Ellernut Hickory	tree	slow
<i>Castalia bignonioides</i>	Southern catalpa	tree	fair
<i>Celastrus scandens</i>	Waxhaw	medium tree	slow
<i>Cornus amomum</i>	Silky dogwood	medium tree	slow
<i>Cornus sericea</i>	Red osier dogwood	medium tree	slow
<i>Coulatanthus occidentalis</i>	Butterbush	large shrub	medium
<i>Chionanthus virginicus</i>	Fringe tree	small tree	medium
<i>Clethra alnifolia</i>	Sweet Pepperbush	shrub	medium
<i>Comus amomum</i>	Silky dogwood	small shrub	medium
<i>Comus florida</i>	Flowering dogwood	medium tree	fair
<i>Diospyros virginiana</i>	Persimmon	medium tree	fair
<i>Elaeagnus argentea</i>	Silver cholla	medium tree	fast
<i>Gleditsia triacanthos</i>	Honeylocust	medium tree	fast
<i>Ilex decidua</i>	Possomhaw	large shrub to small tree	fast
<i>Ilex opaca</i>	American holly	small tree	medium
<i>Ilex verticillata</i>	Winterberry	small to large shrub	medium
<i>Juglans nigra</i>	Baldc walnut	medium tree	fair
<i>Juglans nigra</i>	Eastern catcider	large tree	medium
<i>Liquidambar styraciflua</i>	Sweetgum	large tree	fast
<i>Liriodendron tulipifera</i>	Tulip poplar	medium tree	fast
<i>Marshallia virginiana</i>	Sweetbay	small tree	fast
<i>Nyssa sylvatica</i>	Blackgum	tail tree	slow
<i>Ostrya virginiana</i>	Hophornbeam	small tree	slow
<i>Platanus occidentalis</i>	Sycamore	large tree	fast
<i>Populus deltoides</i>	Eastern cottonwood	tail tree	fast
<i>Quercus alba</i>	White oak	large tree	fast
<i>Quercus prinus</i>	Scarlet oak	medium tree	slow
<i>Quercus rubra</i>	Waller oak	medium tree	slow
<i>Quercus nigra</i>	Willow oak	medium tree	slow
<i>Quercus phellos</i>	Willow oak	medium to large tree	medium
<i>Quercus shumardii</i>	Shumard oak	large tree	slow
<i>Rhododendron alternifolium</i>	Coast azalea	small shrub	slow
<i>Rhododendron viscosum</i>	Swamp azalea	shrub	fast
<i>Salix nigra</i>	Black willow	small to large tree	fast
<i>Viburnum nudum</i>	Swamp haw	large shrub	fast

FIGURE 7D
DOMINION ENERGY
SOUTH CAROLINA, INC.
BIOENGINEERED STABILIZATION
OPTION DETAILS

CONGAREE RIVER MRA
COLUMBIA, SOUTH CAROLINA

DATE: 9/8/20 FILE NAME: CONG584
APEX COMPANIES, LLC

CONSTRUCTION SEQUENCE

1. Receive approval from City of Columbia for NPDES coverage under SCDHEC General Permit.
2. Hold a pre-construction meeting on-site with DESC, contractor, engineer and City of Columbia Stormwater Management Staff.
3. Notify City of Columbia Utilities and Engineering Staff 48 hours prior to beginning land disturbing activities.
4. Mobilize office trailers to the site and place them in the same locations as utilized for previous site activities and reconnect utilities. Utility connections are already present for the trailers and should require minimal to no additional land disturbance to reestablish the connections.
5. Identify historical areas, plant species of concern areas, and other areas of the site that will be safeguarded from being disturbed by construction activities and demarcate them with high visibility fencing or equivalent visual barrier.
6. Install temporary perimeter fencing and access gate for site security.
7. Install initial perimeter control and other sediment and erosion control BMPs associated with the laydown area improvements, including the stabilized construction entrance.
8. Conduct clearing and grading activities in order to construct the material and water management area, laydown area(s) and access road(s). Stabilize disturbed areas through the addition of geotextile overlain by gravel (crusher run or similar material).
9. Grade and reseed with approved seed mixture any disturbed areas not stabilized via geotextile and gravel.
10. Identify additional access points to the river that will be required, if any, for the Area 1 removal area. Install sediment and erosion control BMPs in these areas to permit construction of the additional access road(s). The final road locations will be chosen in the field during implementation and will be based on field conditions, project requirements and the intent to minimize land disturbance and tree removal activities as much as practicable.
11. Demarcate the portions of the riverbank that are intended to be left undisturbed to limit the potential for disturbance during construction and sediment removal activities.
12. Mobilize cofferdam construction personnel and equipment and begin Area 1 cofferdam construction activities. Total Suspended Solids monitoring will be conducted in the river during active river construction operations.
13. Complete landside support zone construction including erecting temporary structure(s) and installing the water management system components.
14. Install run-on diversion controls, as necessary, to control run-on of stormwater from landside support zone into the Area 1 removal area.

15. After cofferdam is in place, dewater planned removal area and begin sediment removal operations. Utilize the river-based removal area for initial draining of entrained water within the excavated sediment and the water management system for collection and filtration of impacted water.
16. Move excavated material from river removal area to temporary structure for additional screening, conditioning and offsite transport to disposal location.
17. Complete Area 1 excavation activities and remove Area 1 cofferdam materials from the river.
18. Reconstruct disturbed areas of riverbank and remove the Area 1 access roads (except where left in place at request of landowner). Grade and reseed the areas with an approved seed mixture.
19. Complete items 8 through 19 for the Area 2 removal area.
20. Following reconstruction of the riverbank in Area 2, the landside support zone will be restored to pre-project conditions (except gravel roads left in place at request of landowner) by removing the temporary structures, geotextile and gravel from the access roads and laydown areas, and grading and reseeding the areas with an approved seed mixture.
21. Remove office trailer(s).
22. After stabilization has been achieved, DESC will submit the Notice of Termination (NOT) to City of Columbia.

FIGURE 8

DOMINION ENERGY SOUTH CAROLINA, INC.

CONSTRUCTION SEQUENCE

CONGAREE RIVER, MRA
COLUMBIA, SOUTH CAROLINA

DATE: 9/10/20

FILE NAME: CONGS87

APEX COMPANIES, LLC

STANDARD NOTES

1. If necessary, slopes, which exceed eight (8) vertical feet should be stabilized with synthetic or vegetative mats, in addition to hydroseeding. It may be necessary to install temporary slope drains during construction. Temporary berms may be needed until the slope is brought to grade.
2. Stabilization measures shall be initiated as soon as practicable in portions of the site where construction activities have temporarily or permanently ceased, but in no case more than fourteen (14) days after work has ceased, except as stated below.
 - a. Where stabilization by the 14th day is precluded by snow or frozen ground conditions stabilization measures must be initiated as soon as practicable.
 - b. Where construction activity on a portion of the Site is temporarily ceased, and earth-disturbing activities will be resumed within 14 days, temporary stabilization measures do not have to be initiated on that portion of the Site.
3. All sediment and erosion control devices shall be inspected once every calendar week. If periodic inspections or other information indicated that a BMP has been inappropriately or incorrectly installed, the Permittee must address the necessary replacement or modification required to correct the BMP within 48 hours of identification.
4. Provide silt fence and/or other control devices, as may be required, to control soil erosion during utility construction. All disturbed areas shall be cleaned, graded, and stabilized with grassing immediately after the utility installation. Fill, cover, and temporary seeding at the end of each day are recommended. If water is encountered while trenching, the water should be filtered to remove any sediments before being pumped back into any waters of the State.
5. All erosion control devices shall be properly maintained during all phases of construction until the completion of all construction activities and all disturbed areas have been stabilized. Additional control devices may be required during construction in order to control erosion and/or offsite sedimentation. All temporary control devices shall be removed once construction is complete and the site is stabilized.
6. The contractor must take necessary action to minimize the tracking of mud onto paved roadway(s) from construction areas and the generation of dust. The contractor shall daily remove mud/soil from pavement, as may be required.
7. Temporary diversion berms and/or ditches will be provided as needed during construction to protect work areas from upslope runoff and/or to divert sediment-laden water to appropriate traps or stable outlets.
8. All waters of the State (WoS), including wetlands, are to be flagged or otherwise clearly marked in the field. A double row of silt fence is to be installed in all areas where a 50-foot buffer can't be maintained between the disturbed area and all WoS. A 10-foot buffer should be maintained between the last row of silt fence and all WoS.

9. Litter, construction debris, oils, fuel and building products with significant potential for impact (such as stockpiles of freshly treated lumber) and construction chemicals that could be exposed to storm water must be prevented from becoming a pollutant source in storm water discharges.
10. A copy of the SWPPP, inspection records and rainfall data must be retained at the construction site or nearby location easily accessible during normal business hours, from the date of commencement of construction activities to the date that final stabilization has been reached.
11. Initiate stabilization measures on any exposed steep slope (3H:1V or greater) where land-disturbing activities have permanently or temporarily ceased, and will not resume from a period of 7 calendar days.
12. Minimize soil compaction and, unless infeasible, preserve topsoil.
13. Minimize the discharge of pollutants from equipment and vehicle washing, wheel wash water and other wash waters. Wash waters must be treated in a sediment basin or alternative control that provides equivalent or better treatment prior to discharge.
14. Minimize the discharge of pollutants from dewatering of trenches and excavated areas. These discharges are to be routed through appropriate BMPs (sediment basin, filter bags, etc.).
15. The following discharges from sites are prohibited:
 - a. Wastewater from washout of concrete, unless managed by appropriate control;
 - b. Wastewater from washout and cleanout of stucco, paint, form release oils, curing compounds and other construction materials;
 - c. Fuels, oils or other pollutants used in vehicle and equipment operation and maintenance; and
 - d. Soaps or solvents used in vehicle and equipment washing.
16. After construction activities begin, inspections must be conducted at a minimum of at least once every calendar week and must be conducted until final stabilization is reached on all areas of the construction site.
17. If existing BMPs need to be modified or if additional BMPs are necessary to comply with the requirements of this permit and/or SC's Water Quality Standards, implementation must be completed before the next storm event whenever practicable. If implementation before the next storm event is impracticable, the situation must be documented in the SWPPP and alternative BMPs must be implemented as soon as reasonable possible.
18. A Pre-Construction Conference must be held for each construction site with an approved On-site SWPPP prior to the implementation of construction activities. For non-linear projects that disturb 10 acres or more, this conference must be held on-site unless the Department (State) has approved otherwise.

FIGURE 9

DOMINION ENERGY SOUTH CAROLINA, INC.

STANDARD NOTES

CONGAREE RIVER MRA
COLUMBIA, SOUTH CAROLINA

DATE: 8/9/20

FILE NAME: COMG571

APEX COMPANIES, LLC

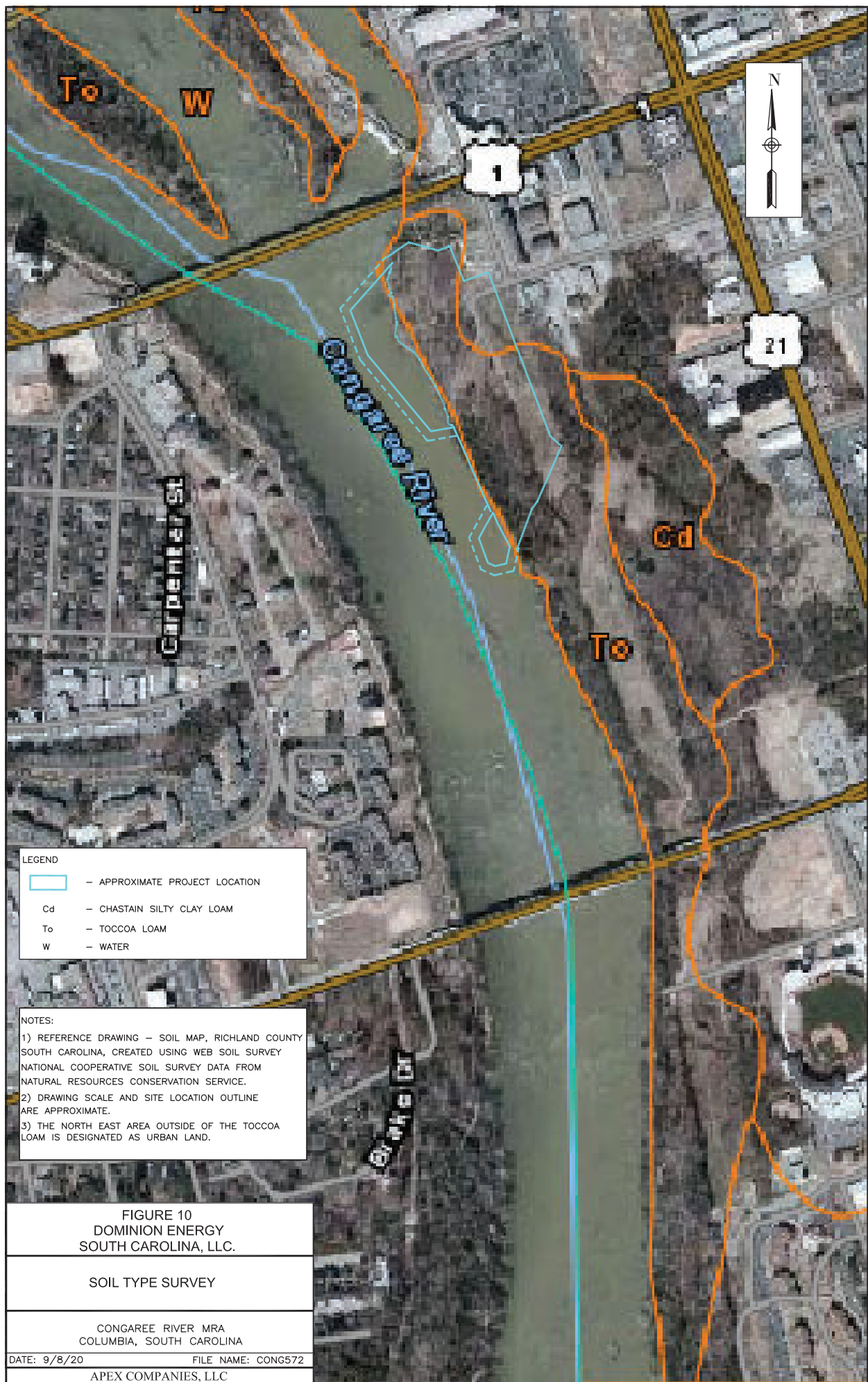

LEGEND

	- APPROXIMATE PROJECT LOCATION
Cd	- CHASTAIN SILTY CLAY LOAM
To	- TOCCOA LOAM
W	- WATER

NOTES:

- 1) REFERENCE DRAWING - SOIL MAP, RICHLAND COUNTY SOUTH CAROLINA, CREATED USING WEB SOIL SURVEY NATIONAL COOPERATIVE SOIL SURVEY DATA FROM NATURAL RESOURCES CONSERVATION SERVICE.
- 2) DRAWING SCALE AND SITE LOCATION OUTLINE ARE APPROXIMATE.
- 3) THE NORTH EAST AREA OUTSIDE OF THE TOCCOA LOAM IS DESIGNATED AS URBAN LAND.

FIGURE 10 DOMINION ENERGY SOUTH CAROLINA, LLC.	
SOIL TYPE SURVEY	
CONGAREE RIVER MRA COLUMBIA, SOUTH CAROLINA	
DATE: 9/8/20	FILE NAME: CONG572
APEX COMPANIES, LLC	

ATTACHMENT L

HISTORICAL AND ARCHAEOLOGICAL PROPERTIES INFORMATION

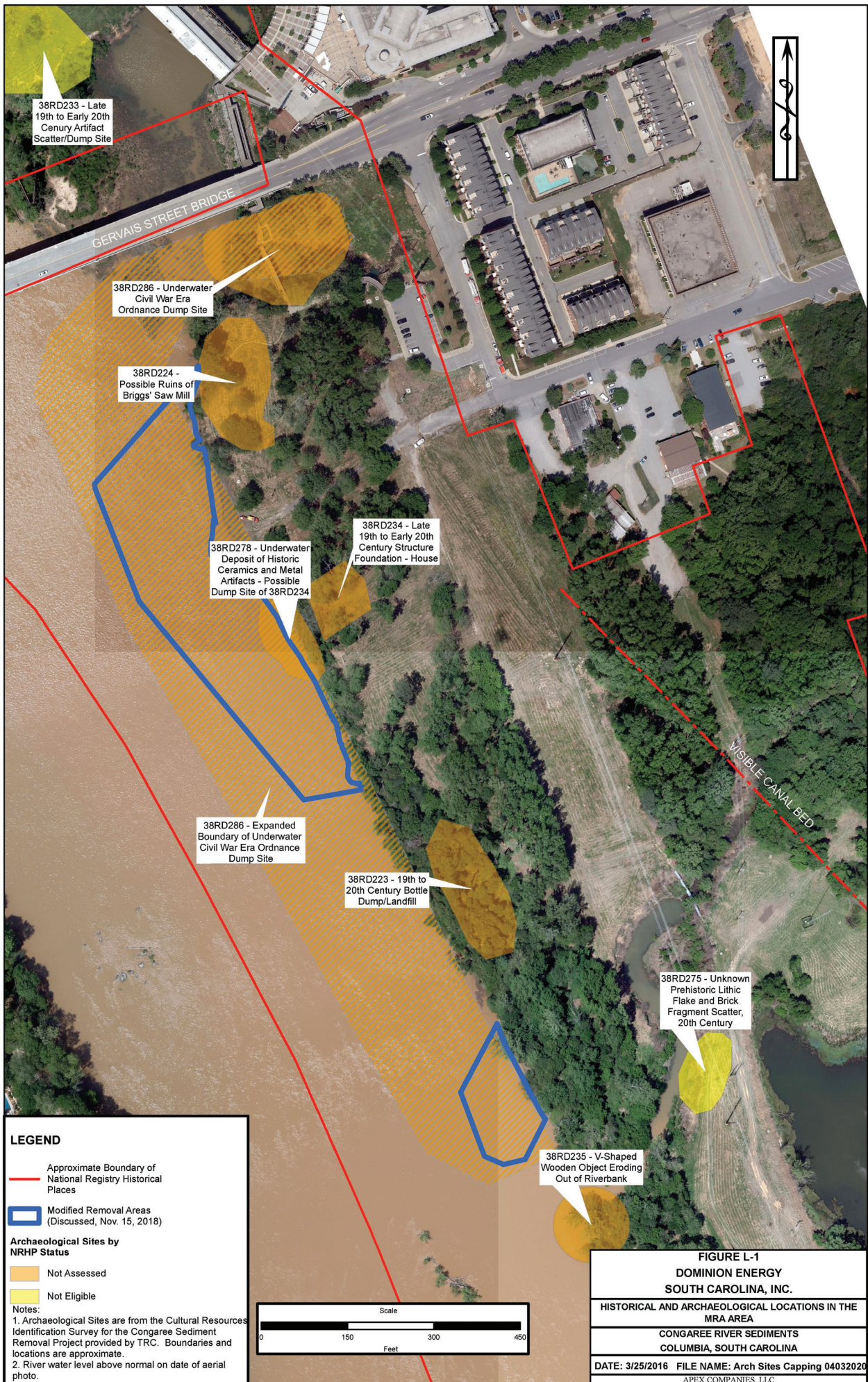

38RD233 - Late 19th to Early 20th Century Artifact Scatter/Dump Site

38RD286 - Underwater Civil War Era Ordnance Dump Site

38RD224 - Possible Ruins of Briggs' Saw Mill

38RD278 - Underwater Deposit of Historic Ceramics and Metal Artifacts - Possible Dump Site of 38RD234

38RD234 - Late 19th to Early 20th Century Structure Foundation - House

38RD286 - Expanded Boundary of Underwater Civil War Era Ordnance Dump Site

38RD223 - 19th to 20th Century Bottle Dump/Landfill

38RD275 - Unknown Prehistoric Lithic Flake and Brick Fragment Scatter, 20th Century

38RD235 - V-Shaped Wooden Object Eroding Out of Riverbank

LEGEND

— Approximate Boundary of National Registry Historical Places

▭ Modified Removal Areas (Discussed, Nov. 15, 2018)

Archaeological Sites by NRHP Status

- ▭ Not Assessed
- ▭ Not Eligible

Notes:

1. Archaeological Sites are from the Cultural Resources Identification Survey for the Congaree Sediment Removal Project provided by TRC. Boundaries and locations are approximate.
 2. River water level above normal on date of aerial photo.



FIGURE L-1
DOMINION ENERGY
SOUTH CAROLINA, INC.
HISTORICAL AND ARCHAEOLOGICAL LOCATIONS IN THE
MRA AREA
CONGAREE RIVER SEDIMENTS
COLUMBIA, SOUTH CAROLINA
DATE: 3/25/2016 FILE NAME: Arch Sites Capping 04032020
APEX COMPANIES, LLC

TABLE L-1

LISTING OF HISTORIC PLACES AND ARCHAEOLOGICAL SITES

DESC Congaree River Site
Columbia, South Carolina

Historic Place ^(1,2)	Location	Level of Significance	Area of Significance
Gervais Street Bridge	Spans Congaree River in West Columbia, SC	State	Architecture
Columbia Canal	East bank of the Broad and Congaree Rivers from the diversion dam to the southern railroad bridge in Columbia, SC	National	Industry

Archaeological Site ⁽³⁾	Location	ID#
Late 19th to Early 20th Century Artifact Scatter/Dump Site	North of the Gervais Street Bridge on the southern tip of the Columbia Canal Dike	38RD233
Underwater Civil War Era Ordnance Dumpsite	East bank of the Congaree River at the outfall of Unnamed Tributary #1 into Congaree River	38RD286
Possible Ruins of Briggs' Saw Mill	East bank of the Congaree River south of the Gervais Street Bridge and Unnamed Tributary #1	38RD224
Late 19th to Early 20th Century Structure Foundation House	East bank of the Congaree River south of the Senate Street Extension boat launch	38RD234
Underwater Deposit of Historic Ceramics and Metal Artifacts	Eastern portion of Congaree River south of the Alluvial Fan	38RD278
19th to 20th Century Bottle Dump/Landfill	Eastern bank of the Congaree River between Area 1 and Area 2	38RD223
Expanded Boundary of Underwater Civil War Era Ordnance Dumpsite	Eastern portion of the Congaree River from the Gervais Street Bridge to Unnamed Tributary #2	38RD286
Unknown Prehistoric Lithic Flake and Brick Fragment Scatter, 20th Century	East bank of the Congaree River to the south of Unnamed Tributary #2	38RD275
V-Shaped Wooden Object Eroding Out of Riverbank	East Bank of Congaree River near mouth of Unnamed Tributary #2	38RD235

Notes:

1. Table includes properties near or coinciding with the Congaree River Stakeholder-Developed Modified Removal Action area included on the National Register of Historic Properties.
2. Historic Place Source: South Carolina Institute of Archeology and Anthropology & South Carolina Department of Archives and History.
3. Archaeological Site Source: Cultural Resources Identification Survey for the Congaree Sediment Removal Project provided by TRC.
4. Figure L-1 provides location of areas listed above.

ATTACHMENT M

**CULTURAL RESOURCE IDENTIFICATION SURVEY,
ARCHAEOLOGICAL DATA RECOVERY PLAN,
DRAFT MEMORANDUM OF AGREEMENT AND CURRENT RECOVERY LICENSE**



CULTURAL RESOURCE IDENTIFICATION SURVEY FOR THE CONGAREE RIVER SEDIMENT REMOVAL PROJECT

RICHLAND COUNTY, SOUTH CAROLINA

Final Report



October 2014



**CULTURAL RESOURCE IDENTIFICATION SURVEY FOR THE
CONGAREE RIVER SEDIMENT REMOVAL PROJECT
RICHLAND COUNTY, SOUTH CAROLINA**

FINAL REPORT

Submitted to:
SCANA
COLUMBIA, SOUTH CAROLINA

Submitted by:
TRC
621 CHATHAM AVENUE
COLUMBIA, SOUTH CAROLINA 29205

A handwritten signature in black ink, appearing to read "Sean Norris". The signature is fluid and cursive, with a long horizontal stroke at the end.

Sean Norris, Principal Investigator, Author

October 2014

TABLE OF CONTENTS

TABLE OF CONTENTS	<i>i</i>
FIGURES.....	<i>ii</i>
TABLES.....	<i>iv</i>
I. INTRODUCTION.....	1
II. ENVIRONMENTAL SETTING	8
Project Setting.....	8
Paleoenvironment.....	8
Historic Environment.....	9
Climate.....	9
Physiography and Hydrology	9
Soils.....	10
III. CULTURAL OVERVIEW	11
PRECONTACT AND CONTACT PERIOD OVERVIEWS	11
Paleoindian Period (ca. 12,500–10,000 B.P.).....	11
Archaic Period (ca. 10,000–3000 B.P.).....	11
Woodland Period (ca. 3000–900 B.P.)	13
Mississippian Period (ca. A.D. 900–1670)	13
HISTORICAL OVERVIEW OF THE PROJECT VICINITY.....	14
Early Settlement in the South Carolina Midlands	14
The American Revolution.....	15
Antebellum Agriculture in the Midlands	16
Civil War.....	18
Postbellum Agricultural Practices	20
Industrialization and Expansion in the Postbellum Era	21
An Agricultural Depression and a National Depression	21
A New Era in a Diversified Economy	22
Previous Investigations in the Project Area.....	22
IV. METHODS AND RESULTS.....	23
Methods	23
Results.....	23
Background and Literature Search.....	23
Field Survey	26
Previously Recorded Resources	26
National Register Listed Resources	37
V. SUMMARY AND RECOMMENDATIONS	44
REFERENCES	45

FIGURES

Figure 1. Project Area and 0.5-mile Search Radius..... 2

Figure 2. Aerial Photograph of the Project Area 4

Figure 3. Conceptual construction plan for proposed access roads and improvements..... 5

Figure 4. Conceptual drawing showing height and style of proposed coffer dam..... 6

Figure 5. Project Area and 0.5-mile Search Radius..... 8

Figure 6. Saxe-Gotha in 1757 (DeBrahms 1757)..... 15

Figure 7. Mills’ 1825 map of the Richland District depicting the approximate location of the project area..... 18

Figure 8. Union Troop locations February 15, 16 and 17, 1865 19

Figure 9. Aerial view of site 38RD223 24

Figure 10. Aerial View of sites 38RD224 and 38RD286..... 27

Figure 11. Conditions at 38RD224. 29

Figure 12. Historic granite blocks used as river walk border. 29

Figure 13. Aerial view of sites 38RD234 and 278 31

Figure 14. Aerial vie of site 38RD286..... 32

Figure 15. Inventory of ordnance captured during the occupation of of Columbia. 34

Figure 16. Locations of potential ordnance base on side magenetic anomolies..... 36

Figure 17. From the project area to the New Brookland Historic District. 37

Figure 18. Previous Gervais Street Bridge circa 1900. 38

Figure 19. From project area to Gervais Street Bridge. Note modern apartment building.... 39

Figure 20. Location of the Canal bed in relation to the project area in 1850..... 40

Figure 21. Location of the canal bed in relation to the project area in 1870..... 41

Figure 22. View from project location to Canal Hydro Plant, facing north. 42

Figure 23. View from Columbia Canal Hydro Plant to project area. Note rip rap..... 43

Figure 24. Example of modern buildings adjacent to the Canal Hydro Plant..... 43

TABLES

Table 1. Archaeological Sites within a 0.5-Mile Radius of the Project Tract. 24

Table 2. National Register Listed Resources within a 0.5-Mile Radius of the Project Tract. .. 25

I. INTRODUCTION

TRC conducted a cultural resource identification survey in anticipation of federal permits required for the Congaree River Remediation Project. The project area is in the City of Columbia within and on the eastern bank of the Congaree River (Figure 1). In June 2010, tarlike material (TLM) was reported near the eastern bank of the Congaree River directly downstream of the Gervais Street Bridge. The South Carolina Department of Health and Environmental Control (SCDHEC) began sampling material from the river and concluded that the source of the TLM was a manufactured gas plant (MGP) that operated on Huger Street in downtown Columbia from 1906 to the mid-1950s. During its period of operation the MGP had allowed coal tar runoff to empty into the Congaree River.

This MGP, after a series of mergers and acquisitions, became one of South Carolina Electric and Gas's (SCE&G) predecessor companies. As a result SCE&G owned the land the former MGP occupied. In 2002 SCE&G had entered into a Voluntary Cleanup Contract with SCDHEC to mitigate the former MGP site. Beginning in 2008 SCE&G removed over 125,000 tons of MGP impacted soil and debris from the Huger Street location. Since the discovery of tar in the river SCE&G has worked with SCDHEC in order to define the extent of the TLM contamination, and has conducted a series of surveys to establish the vertical and horizontal distribution of the TLM. The project area begins directly south of the Gervais Street Bridge and extends downstream for approximately 2,000 feet; it extends approximately 300 feet into the river from the eastern bank (Figure 1).

In 2013 SCDHEC approved the Project Delineation Report and tasked SCE&G to develop an appropriate plan for the removal and mitigation of the contaminated soil. In 2013 a report detailing four "removal action" options was submitted to SCDHEC. The four options were:

1. No Action – Leave the TLM in place.
2. Monitoring and Institutional Controls – Leave the TLM in place; restrict access to the area, and conduct annual monitoring.
3. Sediment Capping and Institutional Controls – Place a physical barrier on top of the contaminated sediment effectively burying the TLM and conduct annual monitoring.
4. Removal – Physically remove the TLM and contaminated sediment.

SCDHEC approved option four as the preferred method of dealing with the TLM. This method was deemed to be the most protective of human health and the environment because it would permanently remove the contaminated sediment. An average of two feet of sediment will need to be removed over the entire project area. This is equal to approximately 40,000 tons of sediment requiring removal and off-site treatment or disposal. The remediation and removal of the TLM and contaminated sediments will involve the following activities:

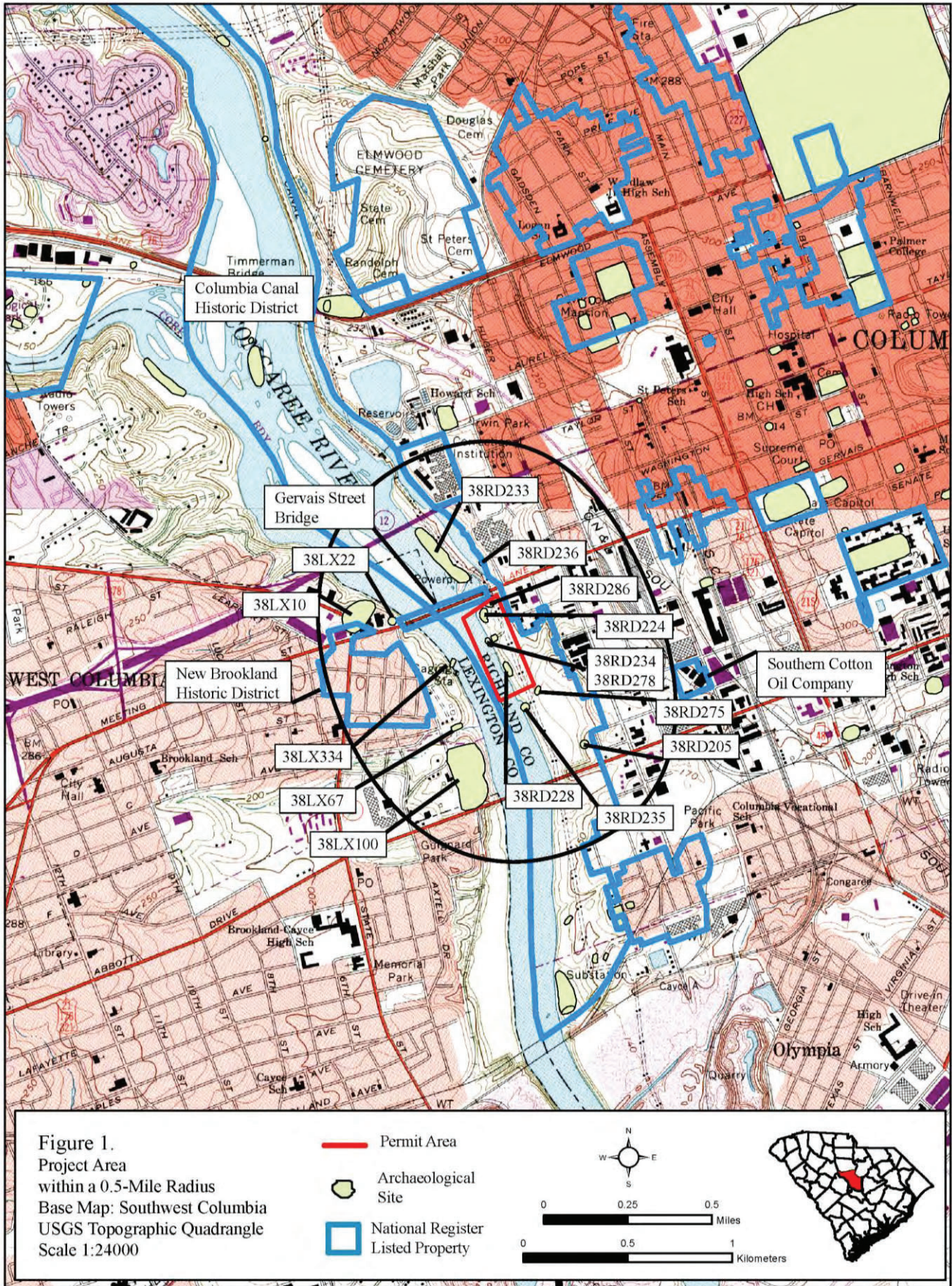

Cultural Resources Identification Survey for the Congaree Sediment Removal Project

- Conducting landside site setup activities;
- Installing a cofferdam of sufficient height to restrict river flow;
- Dewatering of the area to be excavated;
- Physically removing TLM-impacted sediment and debris using conventional equipment;
- Conditioning the sediment material for transportation to the landfill;
- Backfill as necessary; and
- Off-site disposal.

Prior to activities in the river, construction on the eastern shoreline to improve access to the project area for personnel, equipment and material transportation trucks will be conducted. These construction activities would include clearing and grading operations in the area of the Senate Street alluvial fan and along the eastern shoreline as well as improving and/or creating access roads (Figure 2). Access road improvements will raise the existing Senate Street Extension by trucking in a layer of fill from a local quarry and depositing it over the existing ground surface to level and widen the access road. Next a geotextile pad will be placed over the fill. Geotextile is a high tensile strength fabric that stabilizes the ground surface and prevents ruts and the intermixing of gravel with the existing ground surface. Geotextiles are commonly used on construction sites to prevent damage caused by heavy equipment. The fabric used will meet or exceed the South Carolina Department of Transportation's standards for geotextiles. This protective layer will be topped by eight to ten inches of compact gravel effectively raising the existing access road by approximately 12 inches (Figure 3). New access roads will be raised above the current grade using the same procedure. Portions of the riverbank may be excavated in order to create access to the dewatered area.

Site setup activities will also include the construction of a project compound with office trailers, support structures and associated electrical power and utilities. These facilities would be located within the existing utility line corridor. These structures will be temporary. An agreement with the current landowner dictates that no subsurface ground disturbance will be caused by the project compound. Consequently, all temporary structures will be raised above the current grade using layers of fill, geotextile and gravel. Protective fencing would also be installed to restrict access to the work areas by unauthorized personnel.

The first component of the sediment removal will be the construction of a cofferdam around the planned removal areas. The purpose of the coffer dam is to isolate and dewater the areas prior to initiating the removal operations. The coffer dam will be designed to be over-topped during high water events. At average water levels the dam will rise approximately eight feet above the waterline. The temporary dam will be constructed with an impermeable barrier covered by stone or rip rap. Figure 4 is a conceptual rendering showing the approximate height and attributes of the coffer dam.



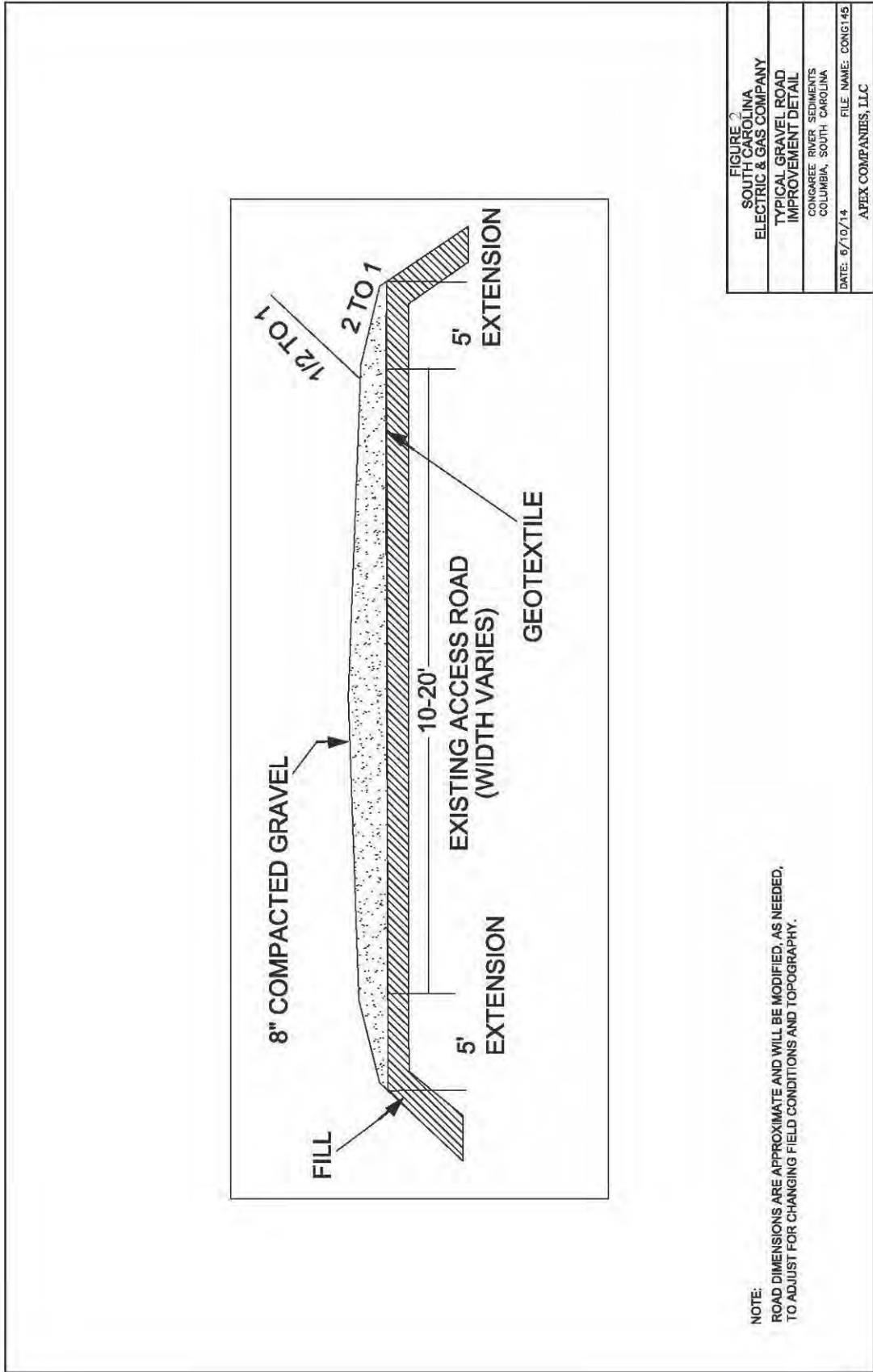

Figure 3. Conceptual construction plan for proposed access roads and improvements.

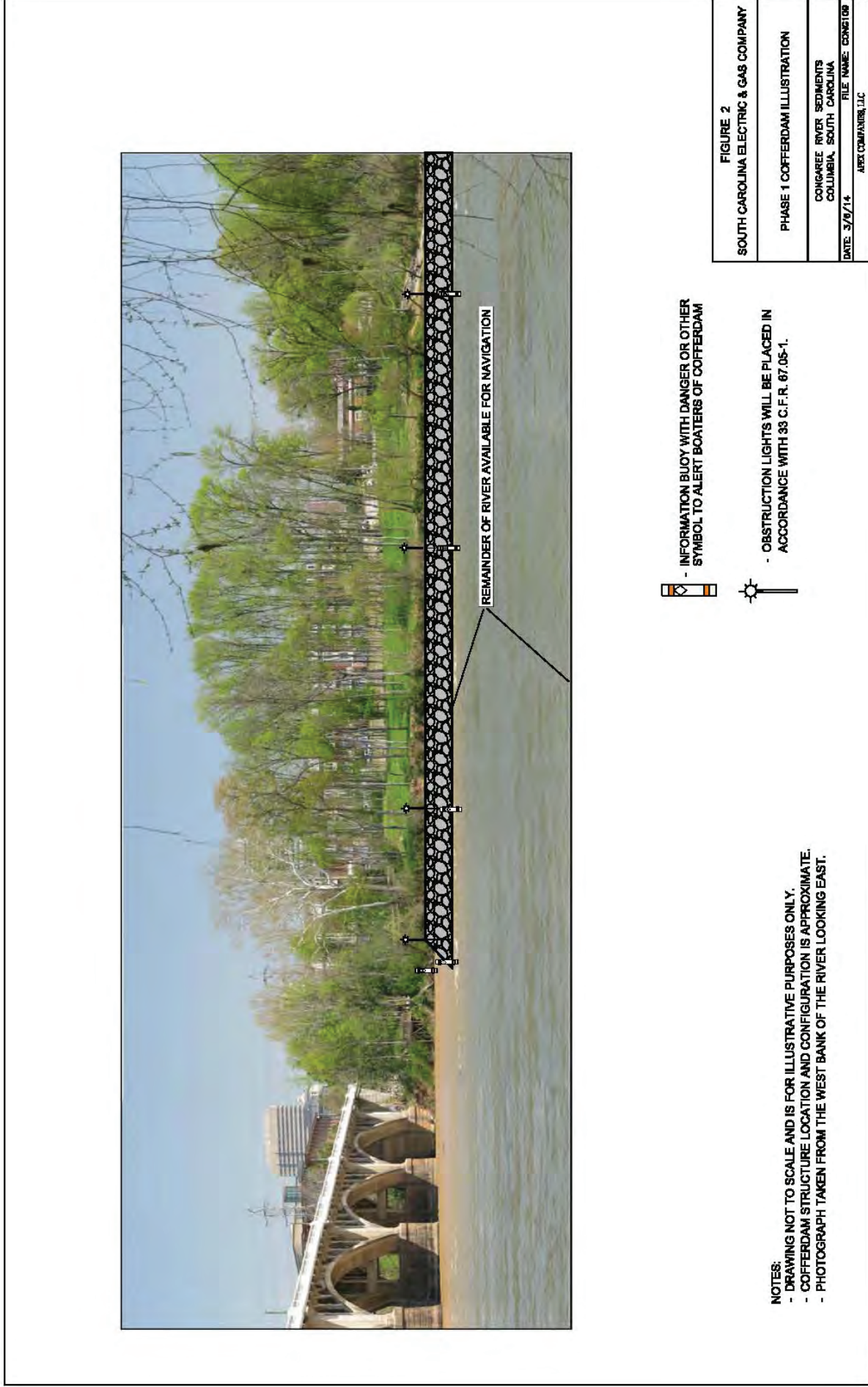

Figure 4. Conceptual drawing showing approximate height and style of proposed coffer dam.

Once the dam is in place there will be a period of dewatering and draining. After the area is dewatered sediment removal will begin. Due to the varying thickness of sediment, the uneven nature of the riverbed and changing conditions within the project area a number of different methodologies and equipment will be employed to complete the project. Generally speaking, heavy equipment/machine excavators coupled with vacuum removal or other techniques will be employed to remove the sediment to bedrock. The sediment will be removed in 50 × 50 foot grid squares.

Once removed, the sediment would likely require drying or solidification prior to transporting. Depending on the amount of TLM in the sediment the material will either be sent to an on-site sorting facility for screening or to an off-site facility for visual examination prior to disposal in a landfill. In order to minimize potential impacts on spawning migrations for threatened and/or endangered species a construction phase (for actual work in the river) would begin no earlier than May and need to end by October of each year. Because of this, and the amount of material to be removed, it is projected that multiple construction seasons or phases will be required. Once each construction phase is completed the river bottom would be restored to its approximate original conditions by the placement of imported fill sand or rock as may be required and the cofferdam would be removed, potentially to be reused as fill or erosion protection.

Due to the limited amount of ground disturbance proposed for this project the Area of Potential Effects (APE) for archaeology is considered to be the portion of the new access roads that will cut into the existing river bank and the dewatered portion of the Congaree River. Due to the low visual profile and temporary nature of the coffer dam a 0.5-mile radius has been used as the APE for above ground resources.

The cultural resource investigations were performed under the direction of TRC Program Manager-Archaeologist Sean Norris, M.A., RPA. Fieldwork was conducted on August 5 and 26, 2014 by Mr. Norris and TRC archaeologist Ramona Grunden.

This report has been prepared in compliance with the National Historic Preservation Act of 1966 (as amended); the Archaeological and Historic Preservation Act of 1979; and procedures for the Protection of Historic Properties (36 CFR Part 800); 36 CFR Parts 60 through 79, as appropriate. Field investigations and the technical report meet or exceed the qualifications specified in the Secretary of the Interior's Standards and Guidelines for Archaeology and Historic Preservation (FR 48:44716–44742) and the *South Carolina Standards and Guidelines for Archaeological Investigations* (SHPO et al. revised 2013). All supervisory personnel meet or exceed the Secretary of the Interior's Professional Qualifications Standards set forth in 36 CFR Part 61.

II. ENVIRONMENTAL SETTING

PROJECT SETTING

The project area is in the Fall Line region of South Carolina. It is characterized by a natural levy overlooking the Congaree River to the west. The project corridor is generally flat and, as stated above, a cleared access, maintenance and utility easement corridor that has been disturbed by underground sewer and gas lines characterizes the project area. It begins at the intersection of Gist and Senate Streets and continues south for approximately 1500 feet. The eastern portion of the project area is in an existing power line and gas line utility easement (Figure 5). The western part of the project area is wooded and undeveloped. Surrounding this is the City of Columbia.

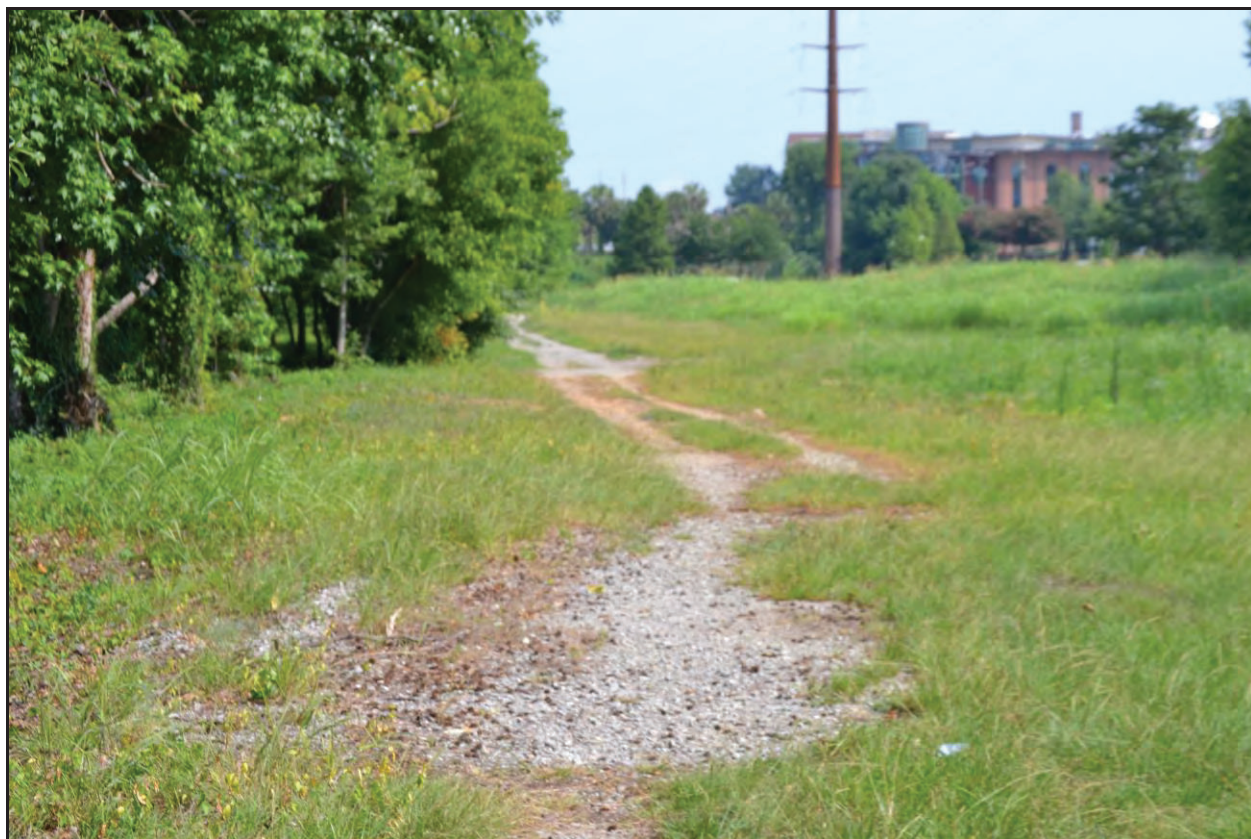

Figure 5. General conditions in the project area.

PALEOENVIRONMENT

The contemporary climate and vegetation of the study area are products of a long and complex process of natural and man-induced change. The average winter temperatures in the study area were obviously considerably colder during the last glacial period, which lasted from ca. 25,000 to 15,000 B.P. At that time, the study area was covered by a boreal forest in which pines and spruce were dominant (Delcourt and Delcourt 1983; Whitehead 1973). The climate warmed and precipitation increased during the Late Glacial Period (ca. 15,000 to 10,000 B.P.), the period during which the first humans arrived in the region. During the late Pleistocene, coniferous

forests were replaced by northern hardwoods as dominant canopy species (Bryson et al. 1970; Watts 1975, 1980; Whitehead 1973). The period ca. 10,000–5000 B.P., referred to as the Altithermal or Hypsithermal, was a period of continued warming but decreased precipitation (Bryson et al. 1970; Watts 1975). The dominant vegetation that survived was the oak-hickory forest (Watts 1975; Whitehead 1973). The climate since ca. 5000 B.P. has cooled slightly, with a possible increase in precipitation. The oak-hickory forests of earlier times decreased in size and became increasingly intermixed with pines (Wharton 1977). Although the earliest settlers reported large stands of yellow pine in the oak-hickory forests of the Piedmont, it is not known whether those stands were products of natural forces or of Native American hunting methods, which used fire to drive and concentrate game.

HISTORIC ENVIRONMENT

The project area is in the Oak-Pine Forest zone characteristic of the Piedmont and Fall Line (Braun 1950). Oaks and hickories are prevalent in this forest, with white oak the predominant species. Pines are also widespread in this zone (Braun 1950). However, the vegetation of the project area has been greatly modified in the past through climatic change, agricultural and silvicultural practices, and development.

Several sources suggest significant changes in the forest composition of the project region during historic times. Lowland vegetation in this area of the state has increased since European settlement. Valley sedimentation led to river and stream aggradation and a general rise of groundwater tables in the valleys. Formerly well-drained valleys with clear streams became swampy, and the streams themselves became muddy and sluggish.

The upland hardwoods probably exhibit the most change since European settlement. These forests, formerly dominant over most of South Carolina, were severely impacted by agricultural clearing in the 1700s and 1800s (Trimble 1974), and again by extensive timbering in the late 1800s and 1900s. In the past, the project area has been subjected to extensive land clearing that has severely altered the natural landscape and environment. Mixed hardwoods, situated along drainages, and loblolly pines mixed with deciduous secondary growth in the uplands, are found in areas that have suffered the least impact from these activities.

CLIMATE

The regional climate is characterized by long, hot, humid summers. The maximum daily temperature is usually near or above 90 degrees Fahrenheit with the minimum in the 65 to 70 degree range. The winter season is short, mild, and relatively dry. The average daily temperatures range from 40 to 45 degrees Fahrenheit. Precipitation is fairly heavy throughout the year and sustained droughts are uncommon. Rainfall is adequate for most crops during the peak-growing season of April–September. Because of the mild winters, precipitation in the form of snowfall is light, averaging about 10–13 inches annually (Kovacik and Winberry 1987).

PHYSIOGRAPHY AND HYDROLOGY

Relief in the project area is generally flat. Immediately west of the corridor the land slopes quickly to the Congaree River. Elevations at the site range from 140 feet Above Mean Sea Level

(AMSL) along the top of the levy to 130 feet AMSL along the tributary bottom and at the jurisdictional wetlands found near the southern terminus of the corridor.

SOILS

The project area contains two soil types:

Chastain Silty Clay Loam is poorly drained and found on floodplain associated with the unnamed tributary that will be spanned and the wetlands near the southern end of the corridor.

Toccoa Loam is found along the natural levy along which the corridor runs. It is deep, moderately well-drained soil found on floodplains and natural levees.

III. CULTURAL OVERVIEW

PRECONTACT AND CONTACT PERIOD OVERVIEWS

Paleoindian Period (ca. 12,500–10,000 B.P.)

The earliest definitive evidence of human occupation in the Southeastern United States has been dated to between 13,500 and 10,000 years before present (B.P.) (Anderson et al. 1996; Goodyear 1999). This time frame, known as the Paleoindian Period, is characterized by a social structure of small, highly mobile groups. Subsistence strategies relied on the hunting of large mammals (e.g., deer, elk, horse, wild pig) combined with the opportunistic hunting of smaller game and the collecting of wild plants and nuts. Megafauna such as mammoth, mastodon, and giant sloth, also would have been obtained, but the extent to which these animals were part of the Paleoindian diet is unknown. The only direct evidence for the exploitation of megafauna in South Carolina is a mammoth rib with cut marks that was found on Edisto Beach near Charleston (Anderson et al. 1992).

The artifacts left by these earliest inhabitants are comprised mostly of diagnostic projectile points, scrapers, graters, denticulates, specialized hafted unifacial knives, large bifacial knives and burins. The most common and widely recognized artifact associated with the Paleoindian period is the fluted point. One of the most recent inventories of Paleoindian artifacts indicated that approximately 350 fluted points have been reported in South Carolina (Anderson et al. 1996). Unfortunately, almost all of these points were recovered by amateur collectors or from surface contexts, making archaeological interpretation difficult. Within the last twenty years only a small amount of Paleoindian material has been recovered from intact contexts in South Carolina and surrounding areas (Anderson and Schuldenrein 1985; Elliott and Doyon 1981; Michie 1996; O'Steen 1994).

Regional variation in projectile point morphology began to emerge in portions of the Southeast by about 11,000 B.P., probably due to restricted movement and the formation of loosely defined social networks and habitual use areas (Anderson 1995). The common point types that have been found throughout South Carolina include Clovis, Cumberland, Suwannee, Quad and Dalton (Anderson et al. 1990; Justice 1987; Milanich and Fairbanks 1980). Some have suggested dividing the Paleoindian into Early, Middle and Late sub-periods based on differences in projectile point morphology (Anderson et al. 1990; O'Steen et al. 1986).

The arrival of new environmental conditions influenced how Paleoindians organized their society. Paleoindians were required to cope with environmental changes and the consequent social pressures that came about during the period of climatic transition associated with the onset of the Archaic Period.

Archaic Period (ca. 10,000–3000 B.P.)

The transition from Paleoindian to Archaic is loosely defined, and in the Southeast the chronological interface ranges from ca. 10,000 to 8500 B.P. In addition to changes in

environmental conditions, changes in technology, settlement patterns, and social organization were developed to cope with this climatic shift. The Archaic period is typically divided into Early, Middle, and Late subperiods based on changes in technology and subsistence through time. It should be emphasized, however, that these subdivisions are artificial constructs and the rate of change across the Southeast varied through time and from place to place.

The Early Archaic (10,000–8000 B.P.) is typically separated from the Paleoindian period by a warming climate and the emergence of seasonal occupation sites. Projectile points are similar to the previous period, but exhibit an increased sophistication through rejuvenation strategies. The typical forms are smaller than those of the Paleoindian period, and include Hardaway, Palmer, and Kirk, Big Sandy, and several bifurcate styles such as MacCorkle, St. Albans, Kanawha, and LeCroy. Wear patterns suggest that these tools were utilized for activities such as killing, butchering, skinning game, and woodworking.

Based on the increased number and size of Early Archaic sites, a population increase appears to have occurred during this period. Consequently, the social landscape became much more complex and settlement models for the Early Archaic period currently are under debate (e.g., Anderson 1992; Daniel 1996, 1998; Ward 1983).

The Middle Archaic (8000–5000 B.P.) marks the introduction of dart points, atlatl weights, and groundstone implements to the lithic tool assemblage. Diagnostic hafted biface types of this period include Stanly, Morrow Mountain, and Guilford points, followed by transitional Middle and Late Archaic Brier Creek and Allendale types. Also included in the Middle Archaic tool kits are groundstone artifacts such as metates and nutting stones, and there is a decrease in the diversity of chipped stone artifacts.

Middle Archaic sites in the Sandhills have been described as small, randomly distributed occupations exhibiting very little intersite technological variability. Local raw materials were used almost exclusively, and the vast majority of tools were technologically expedient (Blanton and Sassaman 1989; Sassaman 1993a).

The Late Archaic (ca. 5000–3000 B.P.) is transitional between the horticultural-based economies of the Woodland period and the previous hunter-gatherer cultures of the Early and Middle Archaic. Population was relatively dense, with large sites documented near major river systems along the fall line and in the Coastal Plain. A variety of imported materials such as copper and steatite, have been recovered from Late Archaic sites. This suggests an increasing complexity in trade relations.

The tool most commonly associated with the Late Archaic period in South Carolina is the Savannah River point. These bifaces, known by various names from Florida all the way into Canada, are often very large (12+ cm in length is not uncommon) and exhibit a straight stem, straight base, and triangular blade. These “points” were likely multifunctional tools used as both spear points and as knives for cutting and skinning.

Other Late Archaic varieties found in the project region include Appalachian Stemmed, small Savannah River Stemmed and Otarre Stemmed, (Sassaman 1985). Like Savannah River hafted bifaces, they are characterized by triangular blades, straight or slightly contracting stems, and

straight bases. The primary difference is size; Savannah River points tend to be longer and wider than the other types. For the most part these type names are more a product of parochial terminology than of actual morphological differences.

Fiber-tempered wares, known as Stallings Island, are found almost entirely along the Savannah River and on the southern South Carolina and northern Georgia coasts during this sub-period (Sassaman 1993b; Stoltman 1974). Inland and along the northern South Carolina coast, a coeval sand-tempered ware known as Thom's Creek is more common. In the Piedmont, pottery is not commonly found on Late Archaic sites, where soapstone vessels were utilized well after they were abandoned on the coast (Sassaman et al. 1990; Sassaman 1993b).

Woodland Period (ca. 3000–900 B.P.)

Whereas the stylistic typologies of projectile points are used to differentiate the Archaic subperiods, changes in ceramic types are used to define the divisions of the Woodland period. The Early Woodland begins at approximately 3000 B.P. with the adoption of pottery across most of the eastern United States. The progression from the Late Archaic to the Early Woodland was gradual, with an increase in the reliance on seeds and planting, and the development of a “big-man” social structure. Reflective of this development in social structure are the use of conical burial mounds and the elaboration of a widespread exchange network that occurs during this period. In the project area, ceramic artifacts dating to this period include the Yadkin and Deptford series (Anderson 1985, Blanton et al. 1986).

Mississippian Period (ca. A.D. 900–1670)

Social, economic, and technological manifestations that are associated with the Mississippian period became established by approximately A.D. 900. Unlike the transitions between the sub-phases of the Woodland period, these changes were dramatic, and some have argued that they occurred when the loosely integrated Late Woodland populations in the region were colonized and acculturated by the chiefdom-level societies that had emerged in the Etowah and Oconee River valleys (Anderson et al. 1996).

This time period represents cultures that were present at the time of initial European contact. The period is marked by a rise of ceremonialism, large public constructions such as pyramidal mounds, and a heavy reliance on the production of domesticated imports such as maize, beans and squash (Smith 1983).

A highly organized village structure developed during this period. Associated with the village lifestyle were rigid social, political and religious systems. Society was stratified and a ruling class exerted ascribed and achieved power over the general population. Central villages were typically located along terraces or levees of major rivers. Smaller villages, hamlets, and isolated family settlements are also characteristic of this period (Ferguson 1971). The increase in population put a strain on the amount of available resources and warfare became endemic. Central towns and villages were fortified with palisades, while small villages and farmsteads were located around the periphery, presumably to facilitate a safe retreat within the palisade in the event of an attack. Smaller villages and farmsteads also would have contributed resources and labor to the main towns.

Ceramic styles have allowed for the differentiation of this period into subdivisions and at least two possible cultural areas. Trinkley (1983) has presented a discussion of the ceramic variability for this period in the South Carolina Coastal Plain and coast, while Anderson and Joseph (1988) have presented one applicable to the South Carolina Piedmont. There is increasing evidence that territorial boundaries between chiefdoms were closely maintained during the Mississippian period.

Evidence of Mississippian chiefdoms has been identified in Georgia, North Carolina, South Carolina, and across much of the southeast. Current research identifies a number of major Mississippian centers along the Fall Line including Hollywood and Lawton near Augusta, Santee Indian Mound on the Santee River, Mulberry and Adamson near Camden, and Town Creek along the Pee Dee River in North Carolina. In addition, one or more small chiefdoms, dating from A.D. 1225–1375, may have been present in the Broad River Valley of the South Carolina Piedmont, not far from the current study area (Green and Bates 2003). In terms of settlement organization, these mound centers formed the center of political power. The ruling elite and a resident population permanently occupied these villages. As political control waxed and waned among elite factions in this politically turbulent era, mound centers were periodically constructed, maintained, and abandoned (Anderson 1990). Many mound centers were abandoned and then reoccupied several times.

HISTORICAL OVERVIEW OF THE PROJECT VICINITY

Early Settlement in the South Carolina Midlands

The South Carolina Midlands, for the purposes of this section, are defined as the City of Columbia and the surrounding counties of Richland, Newberry, Saluda, and Lexington.

In the early eighteenth century, the majority of European settlements remained in the state's Lowcountry. A trading post/fort was erected at "Congaree" in the vicinity of present-day Cayce in the first quarter of the eighteenth century, but there was no large-scale civilian settlement until the 1730s. To protect coastal interests from Spanish and Indian incursion, and to attract European immigrants in the hopes of balancing the ever-growing African slave population, Governor Robert Johnson created 11 townships across the state's northern frontier in the 1730s (Figure 6). The townships were located along rivers in the northern portion of the colony. Saxe-Gotha Township was established on the west side of the Congaree River south of the confluence of the Saluda River. The promise of new land and opportunities brought a large influx of immigrants to South Carolina (Edgar 1998).

The land along the Congaree River became an inviting location for settlement. The area was very appealing to the settlers for the richness of its landscape, which consisted of forests with little undergrowth and large hickory, oak, and pine trees. Most of the new settlers took up farming, along with cattle-grazing, milling, and commercial endeavors including operating ferries and Indian Trade (Salley 1898).

In an effort to attract settlers those arriving in Saxe-Gotha were eligible for a town lot and 50 acres of land per family member (Kovacik and Winberry 1987). Colonists in the Midlands

created settlements that were largely independent of the Lowcountry. Coastal settlements were strongly Anglican, whereas the Midlands people were for the most part dissenters who were often seeking sanctuary to practice their faith unmolested. The coastal citizens were often several generations past the rigors of colonization, unlike the newcomers to the interior. Language, religion, economics, and geography created a barrier of sorts that was not breached until the late eighteenth century and the Revolution.



Figure 6. Saxe-Gotha in 1757 (DeBrahms 1757).

The American Revolution

Poor soils and lack of transportation improvements slowed the growth of the Saxe-Gotha Township until after the Revolutionary War. Prior to the start of the war, the township was virtually abandoned. A small trading center called Granby on the west bank of the Congaree River below the shoals at Columbia was established prior to 1774, and the fort constructed there during the Revolution was active in supplying the military. Located at the head of navigation of the Congaree River, the town became an important shipping point for goods produced on the surrounding agricultural lands, including cotton, indigo, hemp ropes, corn, and beeswax. Likewise, manufactured goods such as fabrics and household wares, and staples such as salt and

coffee were shipped upriver and distributed throughout the Upcountry (Central Midlands Regional Planning Council [CMRPC] 1982).

As the Revolution neared, the dissatisfaction felt by the colonists toward their British leaders was largely concentrated in the coastal areas. Residents of the Midlands and Upcountry became a source of concern for the delegates, however, since they were more disillusioned with the government in Charleston than that of the Royal government. In an attempt to win support from the backcountry settlers, a group of representatives from the Provincial Congress were sent to talk with the area's inhabitants. The first of three meetings took place in the Dutch Fork at McLaurin's Store in present-day Newberry County. William Drayton, leader of the group, later noted in his journal that the meeting went poorly. In the end, the two parties reached an accord; representatives from the South Carolina Midlands and Upcountry regions would sign an agreement stating that they would remain neutral in exchange for the promise that they would no longer be bothered with talk of revolution (Edgar 1998).

At the war's conclusion, South Carolina slowly began the process of reestablishing its government. After the Revolution, Ninety-Six, Orangeburg, Cheraw, and Camden Districts, created in 1769, had become too large to effectively govern. In 1783 the state government decided to divide the existing districts into smaller counties of no more than 40 square miles. Richland County was formed from that part of Camden District located between the Congaree and Wateree rivers. In 1786 vote by the legislature to move the state's capital from Charleston to a new town that would be constructed in a centralized location along the banks of the Congaree River in Richland County. After a great deal of debate, it was decided that the new town would be named Columbia, a name that symbolized the new nation (Edgar 1998).

The site for the capital was chosen because it was centrally located between the upcountry regions and the former capital of Charleston. The location proved to be well situated for the promotion of trade as well. Although it lay beyond the head of navigation by about two miles, the presence of the state and county governments, banks, law offices, and South Carolina College (established in 1801), encouraged growth of the capital. The Columbia Canal, completed in 1824, brought boats into the city, and a series of canals on the Broad, Wateree, and Saluda rivers was constructed to further facilitate trade. For the most part, the use of these canals did not justify the enormous cost to the state for their construction, since they were often inoperable because of a lack of water, damage caused by freshets, or structural and mechanical problems. Nevertheless, they were important in attracting business and industry to the Columbia area. By 1830 the town had a population of 3,310 and could boast of a thriving state college, a State House, town hall and marketplace, numerous churches, a Masonic Hall, two public libraries and a third at the college, a series of bridges spanning its three rivers, and a modest but active spirit of commerce and industry (Moore 1993).

Antebellum Agriculture in the Midlands

The introduction of the cotton gin in the late 1790s transformed the Midlands' economy. Short staple cotton and the cotton gin allowed Midlands farmers access to the wealth and opportunities that had been previously reserved for coastal planters. The possibility of making a large profit from the sale of their cotton crop was a driving reason behind the shift in interest. As a result,

Midlands planters began to invest in infrastructure, educational institutions, and commercial enterprises.

Accompanying the cotton boom during the first portion of the nineteenth century was a statewide effort supporting internal improvements, including new roads and canals to connect the upper and lower parts of the state that had been separated for years both physically and economically. In 1818, the General Assembly established a Board of Internal Improvements to oversee a \$1 million program of roads and canals to improve the state's transportation network (Edgar 1998). Construction started on a system of canals was begun on the Saluda, Broad, Congaree, Catawba, and Wateree rivers.

The state's canal system was largely a disappointment. The plan proposed by the Board of Internal Improvements called for eight canals. Four were to be located on the Catawba and Wateree Rivers above Camden. The Lockwood and Columbia Canals along the Broad River were intended to open up traffic 110 miles north of Columbia, and the Saluda and Dreher Canals along the Saluda River were meant to open up river traffic to Laurens and Abbeville west of Columbia (Edgar 1998). All eight canals were completed and totaled 25 miles of canals and 59 locks that connected every district in the state except Greenville.

The entire canal system was plagued with problems from the outset. Shoddy construction and damage from flooding resulted in the poor operation of the locks. Public disinterest added to operational problems. Lack of use by the public resulted in a failure to generate enough revenue to pay the lock keepers' salaries (Ford 1988). The Saluda River Canals were infrequently used, and their operation was often plagued by either too much or too little water from upstream. No tolls had been collected at the Dreher Canal by 1824, and it was not until 1827 that any evidence has been found of revenues from the canal. Twenty-one boats used the canal that year, carrying 578 bales of cotton. The Columbia Canal can be seen on Mills' 1825 Atlas of Richland District on the east side of the Congaree River (Figure 7).

Despite these setbacks, the area managed to prosper during the first quarter of the nineteenth century, as a result of the cotton boom. Besides the business generated by the state government, Columbia supported a large, but dispersed agricultural community in surrounding Richland and Lexington districts. Merchants, bankers, plantation owners, and real estate speculators capitalized on the flow of goods through Columbia, where cotton from the countryside was loaded onto barges for shipment to Charleston, and manufactured goods from New England and abroad was sold to farmers, peddlers, and storeowners. The new money from the trade encouraged investment, and some of the leading businessmen began to invest in manufacturing enterprises, in hopes of decreasing the state's dependency on imports and improving the return on their money (Lansdell 2003). With a ready supply of cotton available, and a slave labor force to work in the factories, many felt that the South could become the next great textile center.

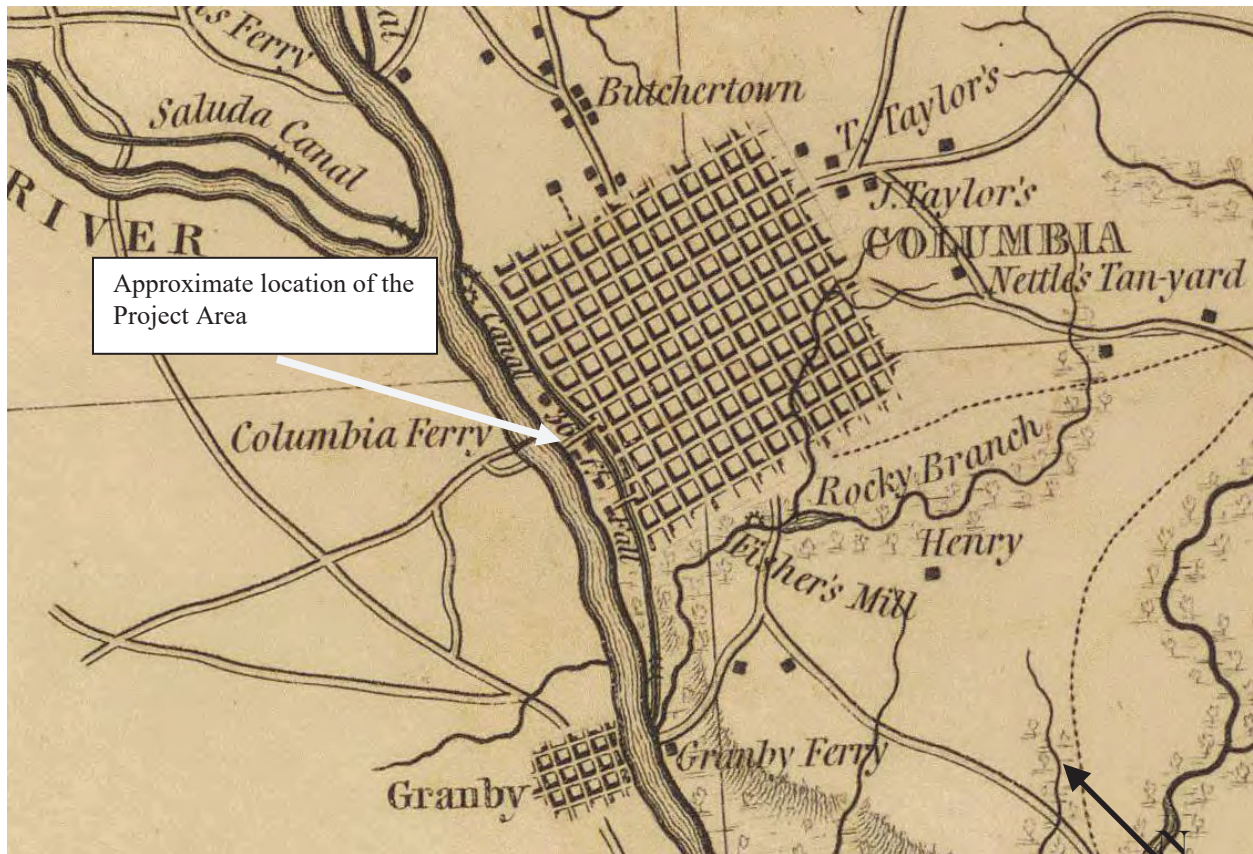

Figure 7. Mills' 1825 map of the Richland District depicting the approximate location of the project area.

Civil War

South Carolinians worried that Abraham Lincoln's victory in the 1860 election would lead to freedom for the black population and the end to wealth that relied heavily on slave labor. Upon hearing of Lincoln's victory, communities across South Carolina convened to discuss what action would be taken in retaliation. On 17 December 1860 delegates from communities across the state unanimously voted to draft an Ordinance of Secession. Following an outbreak of smallpox in Columbia, the convention reconvened in Charleston where the Ordinance was signed on 20 December 1860, and Francis W. Pickens of Edgefield District was elected governor (Pope 1992; Moore 1993).

The Midlands of South Carolina did not witness any military action until the waning months of the war, but the effects of the hostilities were keenly felt. Nearly every man of fighting age was pressed into service, leaving the farms to be run by old men, wives, children, and slaves. Many of the men who served never returned, or were permanently disabled.

Late in 1864, as Union troops moved into Georgia from the north, Confederate authorities began to move prisoners of war from Andersonville and other stockades to what was perceived as more secure territory. The ultimate destinations included Florence, South Carolina for enlisted men and Columbia for officers. It is a sign of the stress war had placed on the Confederate

infrastructure that housing, feeding, and guarding the prisoners was left to the state. In both Florence and Columbia the guards were for the most part too young or too old for active military service. In Columbia the prisoners were first kept at “Camp Sorghum”, so named for the sorghum molasses that made up the bulk of the food supply. Camp Sorghum was located on the west side of the Saluda River in a field near the Saluda Factory. The camp was not fortified and escapes were common, becoming so prevalent that the prisoners were moved in December 1864 to the grounds of the South Carolina Lunatic Asylum.

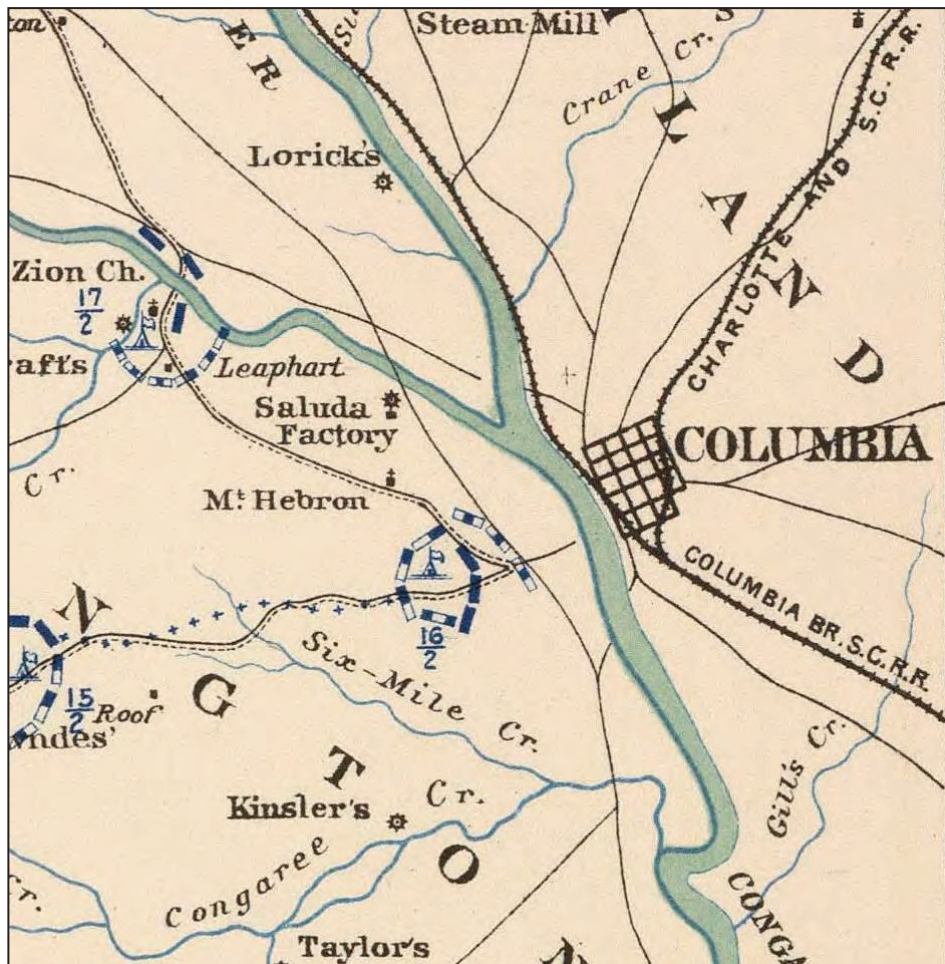

Figure 8. Union Troop locations February 15, 16 and 17, 1865

The infamous “March to the Sea” made by Union troops under the command of General William T. Sherman concluded with the surrender of Savannah in late December, 1864. Some troops remained in coastal Georgia while others were transported to Beaufort and its environs. In mid-January, 1865 the troops were again on the move, this time heading north in what became known as the “Campaign of the Carolinas”. The left wing of Sherman’s army (that is, those furthest west) crossed the

Savannah River at several points, the bulk regrouping at Robertsville (in present day Jasper County) at the end of January, 1865. Heavy rains during the winter caused swollen streams and creeks and often bridges had been burned before the Union forces arrived, slowing the pace of the advance. Nonetheless, the troops averaged approximately 15 miles per day, skirmishing with Confederate troops before them and destroying railroads along the way.

By February 16, 1865 the First, Second and Third Divisions as well as Kirkpatrick’s Cavalry were camped on the west bank of the Congaree River directly across from Columbia (Figure 8). Meanwhile, Columbia’s citizens were trying to evacuate the city, and bales of cotton were dragged into the street to be carried off and burned to keep them from falling into enemy hands.

Wade Hampton, hastily promoted to lieutenant general, was left to defend the city with General Joseph Wheeler's cavalry. Sensing the futility of the defense, Wheeler's men began looting the city, ostensibly to prevent capture by the Union army.

On the night of the 16th, Hampton announced that he planned to evacuate on the following morning, leaving behind the cotton, which he was unable to transport. Sherman's troops began shelling the city, which surrendered the following day. That evening, fueled by spirits dispensed without restriction, Union troops created more mischief through the city. When the cotton in the streets caught fire, they were unable or unwilling to contain the blazes, in some cases probably fanning the flames. The result was the near complete destruction of Columbia (Moore 1993). Having the run of the countryside for several days, Union troops burned many homes and farms in region.

Postbellum Agricultural Practices

Lee's surrender at Appomattox in April 1865 sealed the fate of the Confederacy and launched the South on a difficult course to remodel its social structure around free labor. Soldiers returned home to the Midlands to find desolation. Farmland was barren and plantation houses stood overgrown and decaying. Production and livestock holdings were still below 1860 levels by the time of the 1870 census; widespread corruption in state and local government during Reconstruction further hampered recovery. By 1880, however, cotton production had reached antebellum levels (Kennedy 1990).

The rapid increase in cotton production in the post-war years led to the abandonment of food crops and eventually to a statewide agricultural crisis. Prior to the introduction of cotton, farms had been small and self-sufficient, producing their own food. Eager to make a profit, most farmers reclaimed fields that had previously been reserved for food crops to grow more cotton. When prices began to fall, farmers became desperate to pay off overdue bank loans and in turn over-planted fields, used substandard land for planting, and heavily fertilized their crops in the hopes that increased production would lead to increased profits. In 1860, South Carolina produced 353,412 bales of cotton; by 1890 the figure had reached 747,190 bales. Eventually, the market became flooded with cotton resulting in a drop in the price per pound. Prices fell gradually, but consistently from 1881 through 1886 (Edgar 1998).

African-American farmers faced even greater hurdles in the postbellum period than did their white counterparts. Blocked from owning land by discriminatory banking and real estate practices, blacks generally took up as sharecroppers, sometimes on their old plantations, sometimes in a new location. The sharecropping system proved fundamentally detrimental to both tenants and landlords because of the opportunity for abuse by the landlords in the distribution of the proceeds and the lack of incentives for tenants to make improvements to the land. As lands became exhausted, tenants sought new arrangements, moving from farm to farm, but seeing no improvement in their situation.

A worldwide agricultural depression and the arrival of the boll weevil during the 1920s further eroded the established agricultural regime of the region. By 1930, tenancy levels in South Carolina had begun to stabilize, but the number of farms decreased as tenants left farming for other employment (Edgar 1998).

Although the tenant system led to widespread poverty in the region over the long run, cotton farming and the associated textile industry formed the basis of the region's economy from the end of the Civil War until the beginning of World War II.

Industrialization and Expansion in the Postbellum Era

While agriculture was the mainstay of the Midlands' economy until the mid-twentieth century, the late nineteenth and early twentieth centuries saw rapid changes in transportation and manufacturing. The post-Civil War years saw the continuing development of the state's railway system. By 1880, cities such as Columbia began to once again grow and prosper as the cotton market continued to expand. Many of these towns became major cotton markets as trains running through the area allowed the easy shipment of cotton and other agricultural products.

The opening of the improved Columbia Canal in 1891 resulted in new mills and factories being constructed, and between 1880 and 1900 the population of Columbia doubled to 21,108. The South Carolina textile industry saw a dramatic increase with 61 mills either built or expanded between 1895 and 1907, becoming the largest textile producing state in the South. Columbia Mills, on the east side of the Congaree River at Columbia, became the first mill in the state to operate solely on hydroelectric power generated from the Columbia Canal, and a host of other mills soon followed suit.

An Agricultural Depression and a National Depression

An economic depression hit South Carolina in 1921, almost a decade before it was felt throughout the rest of the country. The collapse of cotton and tobacco prices, overseas competition, and the advance of the boll weevil took a heavy toll on the local economy. The boll weevil arrived in South Carolina in 1917, but it was not until 1922 that short staple cotton crops were affected (Edgar 1998). The price would rebound slightly, but remained low until World War II.

The arrival of the 1930s saw an agricultural system on the brink of collapse. Farmland and associated buildings stood at half of their original value and many farms across the state were mortgaged with owners surviving on borrowed money. Over-planted and over-fertilized land caused major erosion problems (most notably in the upstate) and by 1934, eight million of the state's farming acreage had been declared useless (Edgar 1998). The agricultural crisis of the 1920s and 1930s triggered a mass exodus of residents from the state. Because of the growth of Columbia, Richland County did not see a large decline in population, but residents were moving from the rural areas to the more urbanized areas close to the capital (Moore 1993).

It took some time for the effects of the nationwide Depression that came on the heels of the 1929 Stock Market Crash to be felt in the South Carolina Midlands. The construction of Lake Murray and the active cotton mills kept employment high until the end of 1930. New Deal work programs such as the Civilian Conservation Corps, Works Progress Administration, and Public Works Agency helped bridge the gap until the material and personnel demands of World War II pulled the country out of economic collapse (Moore 1993).

A New Era in a Diversified Economy

World War II finally brought an end to the Depression in the region. The war years saw an increase in agricultural production and manufactured products, as many South Carolina businesses became government contractors. Fort Jackson, established in Richland County during World War I, but virtually abandoned since the end of that war, was revived during World War II for infantry training. In 1940, a site between Six Mile Creek and Congaree Creek in Lexington County was chosen by the U.S. Army for an airfield, which was completed that same year. After World War II, the facility was turned over to the local governments for a regional airport to serve the Columbia area. At the war's close, veterans came home with renewed ambition and many quickly stepped forward as leaders of their communities. Soldiers took advantage of the G.I. Bill, obtaining an education and utilizing their newly developed skills throughout the community. In the years immediately following World War II, veterans opened businesses throughout the area, some of which are still in operation today (Pope 1992; Moore 1993).

Previous Investigations in the Project Area

An examination of materials on file at the SCDAH and SCIAA revealed one project that has a bearing on the current survey. In 1981 the South Carolina Institute of Archaeology and Anthropology (SCIAA) conducted a preliminary archaeological assessment of the Riverfront Park area and adjacent portions of the Historic Columbia Canal (Canouts and Harmon, 1981). The work consisted of a background literature review and a field reconnaissance survey with limited subsurface testing. The goal of the work was to document specifics of the canal and its features that were not well defined in the National Register Nomination Form. Recommendations for further archaeological studies were provided.

The report found that the area south of Gervais Street “has been drastically altered by the construction of a transmission line and other activities” (Canouts and Harmon, 1981). Despite the disturbance a number of archaeological resources were identified. These resources will be discussed in Chapter IV. Interestingly, the report notes that the National Register nomination form for the Columbia Canal Historic District states that portions of the canal are visible from Gervais Street south to Green Street, however they were unable to locate the canal bed itself and state that the canal route disappears in the area of Bicentennial Park. The report recommended further study.

IV. METHODS AND RESULTS

METHODS

The APE for archaeology for this project is considered to be the areas to be impacted by the proposed project. This includes the dewatered portion of the Congaree River and the upland locations of access roads and project compound. Repeated requests to shovel test the APE were denied by the property owner. Consequently no subsurface testing was conducted during the course of the project. A pedestrian survey was carried out along the existing dirt and gravel access road and the wooded area adjacent to the project compound. The entire road was walked on two separate occasions. The road surface was visually inspected for cultural material. Transects spaced approximately 15 meters apart were walked within the wooded portion of the project boundary. Photographs were taken at the locations of previously recorded sites.

RESULTS

Background and Literature Search

Prior to fieldwork, TRC conducted background research at the site files of the South Carolina Office of State Archaeology housed at SCIAA. This research included examination of archaeological sites, structures, and National Register of Historic Places (NRHP) files. The background research gathered information concerning the presence of known archaeological sites, historic structures or cemeteries, or potential sites on or in close proximity to the project area. Previous Recorded Archaeological Sites

Background research established that there are five previously recorded sites within the permit area. Site 38RD223 is a large nineteenth to twentieth century dump/sanitary landfill site located on a bluff overlooking the Congaree River (Canouts and Harmon, 1981). It is noted that the site has been disturbed by pot hunters although portions of it may be in good condition. This site was not assessed as to its National Register eligibility.

Site 38RD224 is interpreted as the possible ruins of Briggs' sawmill. Canouts and Harmon (1981) note a building foundation adjacent to a small tributary of the Congaree River. This site has not been assessed for the National Register.

Site 38RD278 is an underwater discovery of historic ceramics and metal artifacts. It is adjacent to site 38RD234 and may be a dump site from that structure.

38RD286 is Civil War era ordnance dump site. Its boundaries are currently defined as being localized to a small unnamed tributary of the Congaree River just south of the Gervais Street Bridge. Historic documentation indicates that the site extends beyond its currently defined boundaries. Recent side scan sonar magnetometer surveys conducted in advance of the Congaree River Cleanup project support this notion. Currently the site has not been formally investigated by professional archaeologists. The South Carolina State Underwater Archaeologist has issued salvage licenses in the past to recreational divers to conduct recovery work at this site. Log reports associated with these salvages confirm the presence of Civil War ordnance.

Site 38RD234 was recorded as the ruins of a late nineteenth to early twentieth century house with a visible brick porch house footings and a “square brick enclosure that could be a house well” (SCIAA Site Form 1982). No evaluation of this site was made at the time it was recorded.

Table 1. Archaeological Sites within a 0.5-Mile Radius of the Project Tract.

Site No.	Description	NRHP Status
38LX10	Paleoindian through Late Archaic Campsite	Not Assessed
38LX22	Woodland Period Lithic and Ceramic Scatter	Not Assessed
38LX67	Lithic Scatter	Not Eligible
38LX100	Guignard Brick Works	Listed
38LX334	Underwater Shipwreck Site	Not Assessed
38RD205	Middle-Late Archaic Lithic Scatter, destroyed	Not Eligible
38RD223	19 th -20 th Century bottle dump, land fill	Not Assessed
38RD224	Briggs Saw Mill	Not Assessed
38RD233	19 th – 20 th Century Artifact Scatter	Not Eligible
38RD234	Late 19 th Early 20 th Century structure foundation	Not Assessed
38RD235	V-shaped wooden object eroding out of river bank	Not Assessed
38RD236	Historic Period Dugout Canoe in Riverbank	Not Assessed
38RD275	Unknown Prehistoric lithic scatter, 20 th century	Not Eligible
38RD278	Underwater deposit of historic ceramics	Not Assessed
38RD286	Underwater Ordnance Dump Site	Not Assessed

Including the five sites mentioned above there are 15 previously recorded archaeological sites located within a 0.5-mile radius of the project area (Figure 1, Table 1). On the project side of the Congaree River,

Site 38RD205 is just north of Blossom Street in what is currently a parking lot. It was recorded in 1979 as a surface scatter of quartz thinning flakes and two quartz bifaces. The bifaces were dated to the Middle and Late Archaic Period. The South Carolina Site Form indicates that the artifacts were recovered from an active construction site and no further work was recommended for the site.

38RD233 is late nineteenth to early twentieth century dump site on an island across from the Columbia Canal Power House and the Gervais Street Bridge. It is not eligible for the National Register.

Canouts and Harmon (1981) initially identified site 38RD235 as an isolated find, it was later assigned an official site number. It is described as “V-shaped wooden object” measuring approximately 3.5 meters in length and 60 cm in width. They interpret this as being either a fragment from a boat or an industrial trough of some sort that was dumped in the river.

Site 38RD236 is on the same island as 38RD233. It is an historic period dugout canoe that was observed by Canouts and Harmon (1981) eroding out of the canal side of the island.

Site 38RD275 is a small surface scatter consisting of two prehistoric lithic flakes and a scatter of twentieth century brick fragments. It was noted as being disturbed and not recommended for additional work (SCIAA site form 1982).

On the opposite side of the river from the project area site 38LX10 is a large site investigated in the late 1930's by Robert Wauchope (SCIAA site form). It was recorded as containing a Clovis Point and net weights and a pipe carved out of steatite. The exact location of the site is unknown. 38LX22 and 38LX67 are prehistoric artifacts recovered by amateur collectors in the 1970's. They have not been formally assessed and their locations are approximate. 38LX100 is the Guignard Brick Works. This site is on the National Register of Historic Places. It is located on the west side of the Blossom Street Bridge. The brick works were active for the first half of the twentieth century. Structures associated with the brick works including "beehive" or circular kilns, and a one-story, brick office building are still standing. The brick works are approximately 0.28 mile southwest of the project area. A large, modern apartment complex and tall trees lie between this site and the project area. The project will have no effect on this NRHP listed site.

38LX334 is an underwater resources identified by Canouts and Harmon (1981). It is the wreck of the City of Columbia, a steamship that sank in the early twentieth century. This wreck has not been evaluated. Underwater investigation and special conservation methods would be necessary to fully assess this site.

A review of Archsite website (online GIS database of recorded South Carolina cultural resources) indicates that the project area is within the Columbia Canal Historic District. The Columbia Canal Historic District encompasses an approximately 4.1 mile long area along the eastern bank of the Broad and Congaree Rivers. The northern boundary of the district is defined as the dam of the Columbia Reservoir approximately 0.5-mile upstream from the Broad River Road Bridge. The southern boundary is effectively at the railroad trestles and quarry on the south side of Granby Park. The National Register Nomination form defines this area as the "minimum acreage necessary to protect the historic integrity of the canal". The Nomination form indicates that the nominated area of the canal follows the area outlined in the *Columbia Canal Study* (Wilbur Smith and Associates 1979). The western boundary line of the district was delineated as the western bank of the Broad River until it meets the Saluda River and becomes the Congaree. From there south, the western boundary is defined as the Richland/Lexington County Line. The eastern boundary of the district was determined by using the property lines as they existed in 1979. Property lines were used to define the district since a complete appraisal of the area by archaeologists and a surveyor was not feasible. In the project area the district boundary follows the property lines of land belonging to Guignard Estates.

There are four other National Register listed districts or structures, including the previously mentioned Guignard Brick Works (38LX100), within a 0.5-mile radius of the project area.

Table 2. National Register Listed Resources within a 0.5-Mile Radius of the Project Tract.

Resource	Description	NRHP Status
Columbia Canal	1824 and 1891 Canal and Associated Recouces	Listed
Gervais Street Bridge	Circa 1928 Bridge	Listed
Guignard Brick Works	20 th Century Brick Kilns and facility	Listed
New Brookland Historic District	Early 20 th Century Mill Village	Listed
Southern Cotton Oil Company	Early 20 th Century Cotton Oil Mill	Listed

The Gervais Street Bridge overlooks the project area from the north. This is an open spandrel arch bridge constructed between 1926 and 1928. Ferry crossings and bridges have historically been present in this approximate location since the 1790's. During the Union invasion of Columbia in 1865 the wooden bridge that was at this location was burned in an attempt to slow Sherman's troop advancement into the city.

The New Brookland Historic District is approximately 0.2 miles west of the project area. This is a mill village constructed for the employees of the Columbia Duck Mill, the mill that was hydroelectrically powered by the Columbia Canal. A large number of commercial buildings and residences associated with the various growth phases of the mill are still present and in good condition.

The Southern Cotton Oil Company is approximately 0.50 miles east of the project corridor. This was one of the first and one of the largest cottonseed and cotton oil mills in the country. Similar to olive oil, cottonseed oil saw a boom period in the early 1900's thanks to aggressive promoters of the cotton oil industry. In 1994 there were seven extant structures associated with the Southern Cotton Oil Company. Subsequent to its listing on the National Register all seven buildings were demolished and removed.

Field Survey

Previously Recorded Resources

38RD223 – According to Canouts and Harmon (1981) this is a relatively large site measuring approximately 3000 square meters. This late nineteenth to early twentieth century bottle dump was located in a stand of hardwoods and dense undergrowth (Figure 9). They note that approximately 25% of the site was disturbed by pot hunters. A visit to the site identified an area relatively clear of undergrowth. The site has continued to be a dumping ground for the past 30 years. Plastic glass and metal containers, articles of clothing and modern refuse has been spread over and mixed with the bottle dump. It appears that the vegetation in the area is regularly mowed to minimize the undergrowth. It is unknown how much this grounds keeping has disturbed the site. No shovel tests were excavated at the site. It is believed that historic bottles may still be present. The plans for the Congaree River Sediment Removal Project call for the avoidance of this site. As seen in Figure 2 access roads are proposed to the north and south of this site. Monitoring during construction of the access roads is recommended to ensure that no significant artifact deposits are disturbed during the undertaking. The site remains unevaluated for the National Register. Further work in the form of subsurface shovel testing and artifact identification is necessary to determine the NRHP eligibility of this site.

38RD224 – In 1981 Canouts and Harmon located a building foundation approximately 60 meters downstream of a small unnamed tributary of the Congaree River (Figure 10). The ruins were noted as being in good condition and were assumed to be the remains of Briggs sawmill, a mill utilized by the Confederate government and burned by Union Troops in 1865. The site was considered significant and recommended for additional work.

This site was visited and an attempt to locate the foundation and any historic artifacts visible on the ground surface. A picture of the foundation shows stacked, large granite blocks. Transects

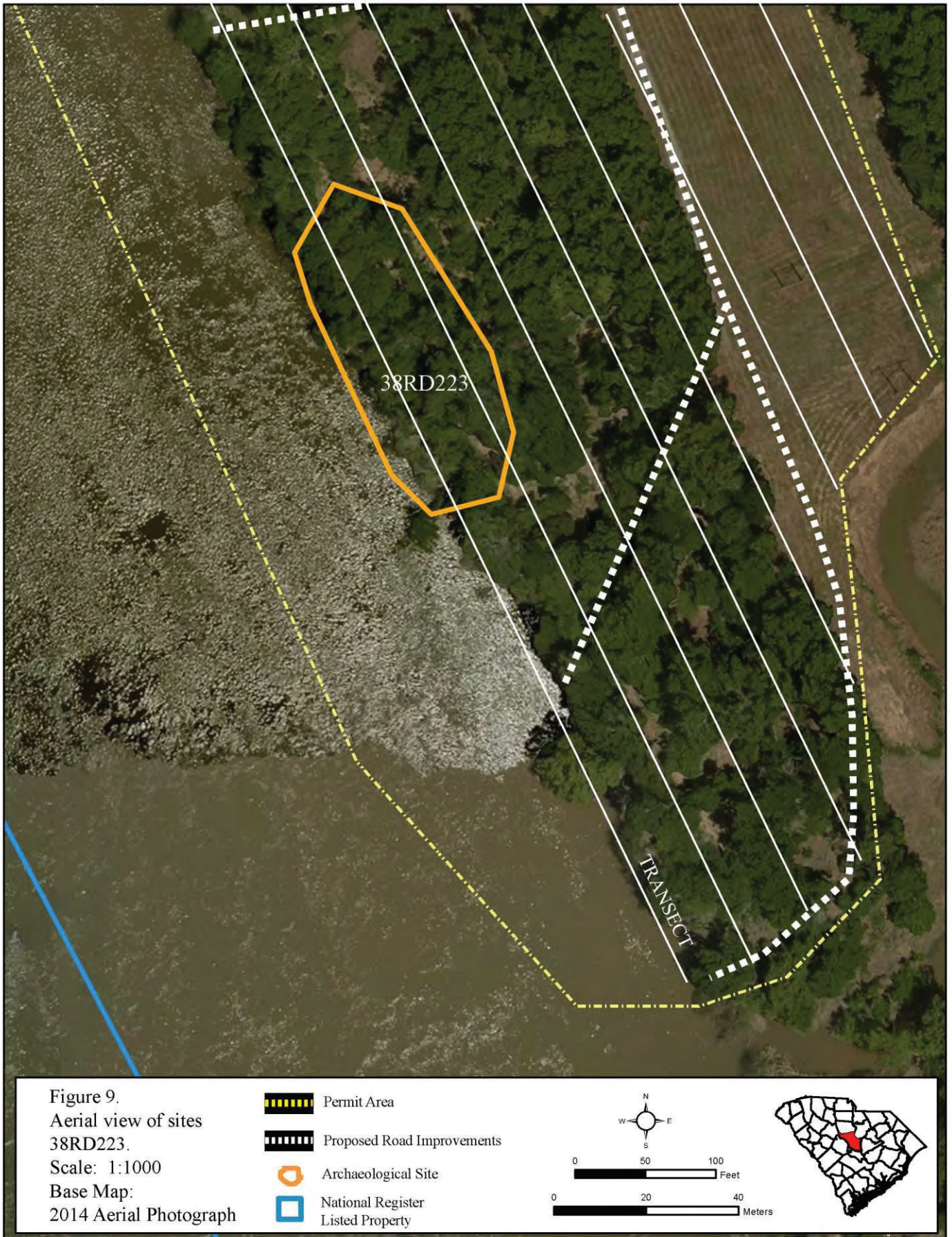

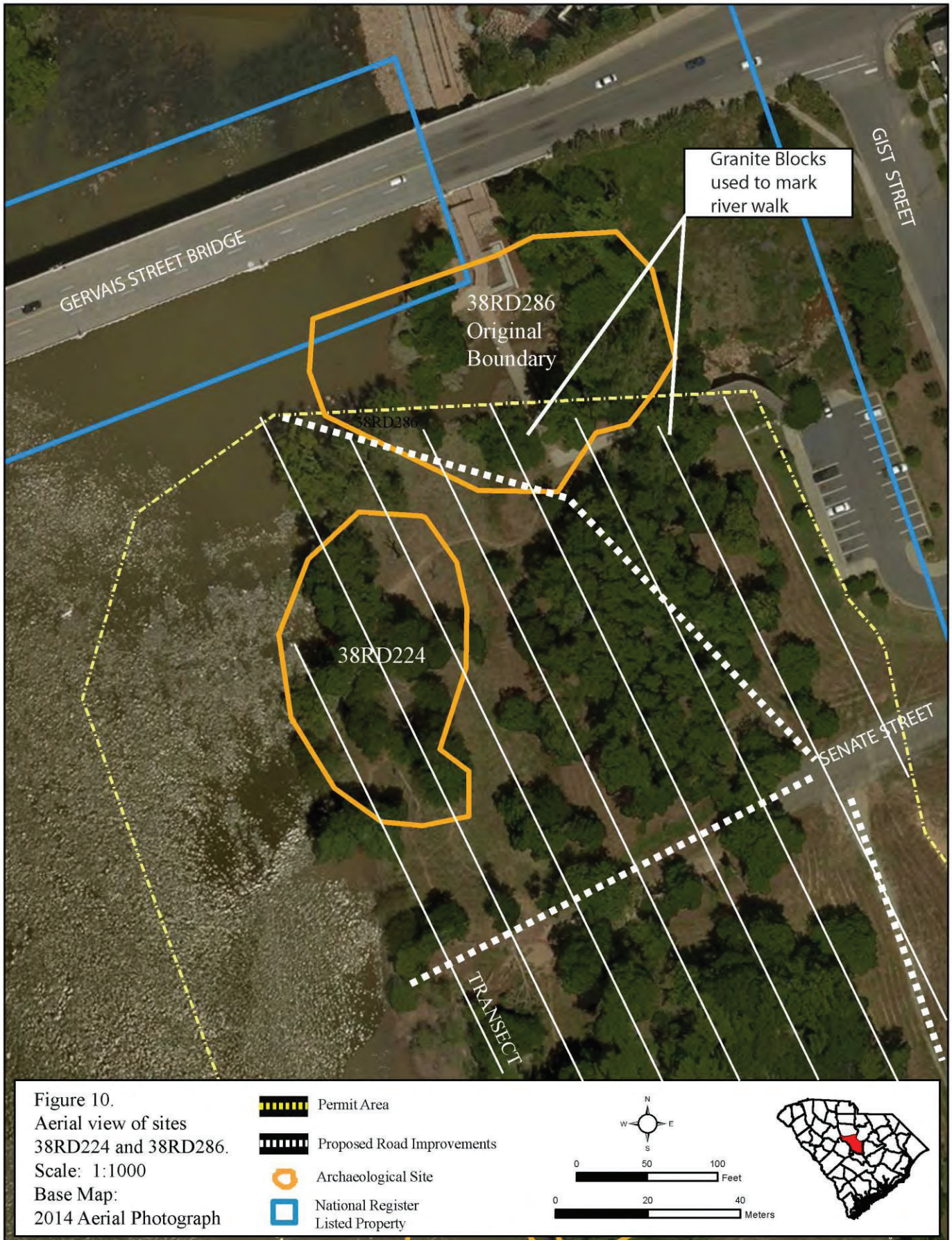



Figure 11. Conditions at 38RD224.



Figure 12. Historic granite blocks used as river walk border.

separated by a 15 meter interval were walked in the mapped location of the site. Vegetation consisted of manicured grass in the upland portion of the site and shin high grasses and undergrowth closer to the river's edge (Figure 11). No trace of an intact granite foundation was found. While accessing the site via the City of Columbia River Walk large granite blocks were noted lining the pathway and marking drainage areas (Figure 12). These blocks are presumed to be the foundation stones identified in 1981 now repurposed as decorative elements to the river walk.

The foundation of the possible sawmill has been disturbed. However, it is possible that intact, subsurface features related to the mill are present. Currently the Congaree River Sediment Removal Project plans to avoid this area. An access road to facilitate dam construction is proposed just north of this site (see Figure 10). It is recommended that monitoring during construction of this road take place to ensure that no significant resources be impacted. Orange construction fencing may be needed to ensure that no activities take place within the boundaries of this site.

38RD234 – Was identified during a reconnaissance survey of the proposed Bicentennial Park. There is no official report of this survey however the SCIAA site form indicates that the site was recorded by SCIAA/Harmon in 1981. The site is recorded as nineteenth century architectural remains that include house footings, a partially intact brick porch and a square brick enclosure which was interpreted as a well house. Woodland Period pottery was also recovered. The site is located approximately 100 feet south of the Senate Street Landing (Figure 13). Similar to Site 38RD224 the area around this site has been periodically cleared over the last 30 years. Pedestrian transects within the boundaries of the site were unable to relocate the well house, brick porch or house footings. The site remains unassessed as to its National Register eligibility. Plans call for the avoidance of this site during the proposed undertaking. It is recommended that monitoring occur during any road construction in the vicinity of this site.

38RD278 -- This site is an underwater resource located immediately west of 38RD234 (see Figure 13). The site was examined in the early 1980s by Cleveland Huey under South Carolina Underwater Salvage License 26. Historic ceramics, a pewter spoon and prehistoric ceramics were reportedly recovered. It is likely that this site represents a dumping area for the structure associated with 38RD334. This site has not been evaluated for the National Register and due to it being underwater was not revisited. The site is in the permit area and will be impacted by the Congaree River Sediment Removal Project. The boundaries of this site will be encompassed within the newly expanded boundary of site 38RD286 (see below). Recovery and evaluation of artifacts associated with this site should occur concurrently with the mitigation of 38RD286.

38RD286 The Ordnance Dump Site – This site was originally recorded as being within an unnamed tributary of the Congaree River, immediately south of the Gervais Street Bridge (Figure 14). It is the recorded location of where munitions captured by the Union during the invasion of Columbia were dumped.

On February 17, 1865 General Sherman's troops captured Columbia. During the two day occupation, live munitions and other weapons of war housed at the Palmetto Armory were



Figure 13.
 Aerial view of sites
 38RD234 and 38RD278.
 Scale: 1:1000
 Base Map:
 2014 Aerial Photograph

-  Permit Area
-  Proposed Road Improvements
-  Archaeological Site
-  National Register Listed Property

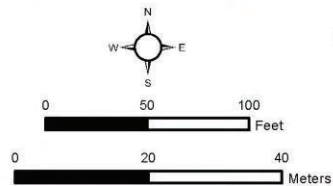

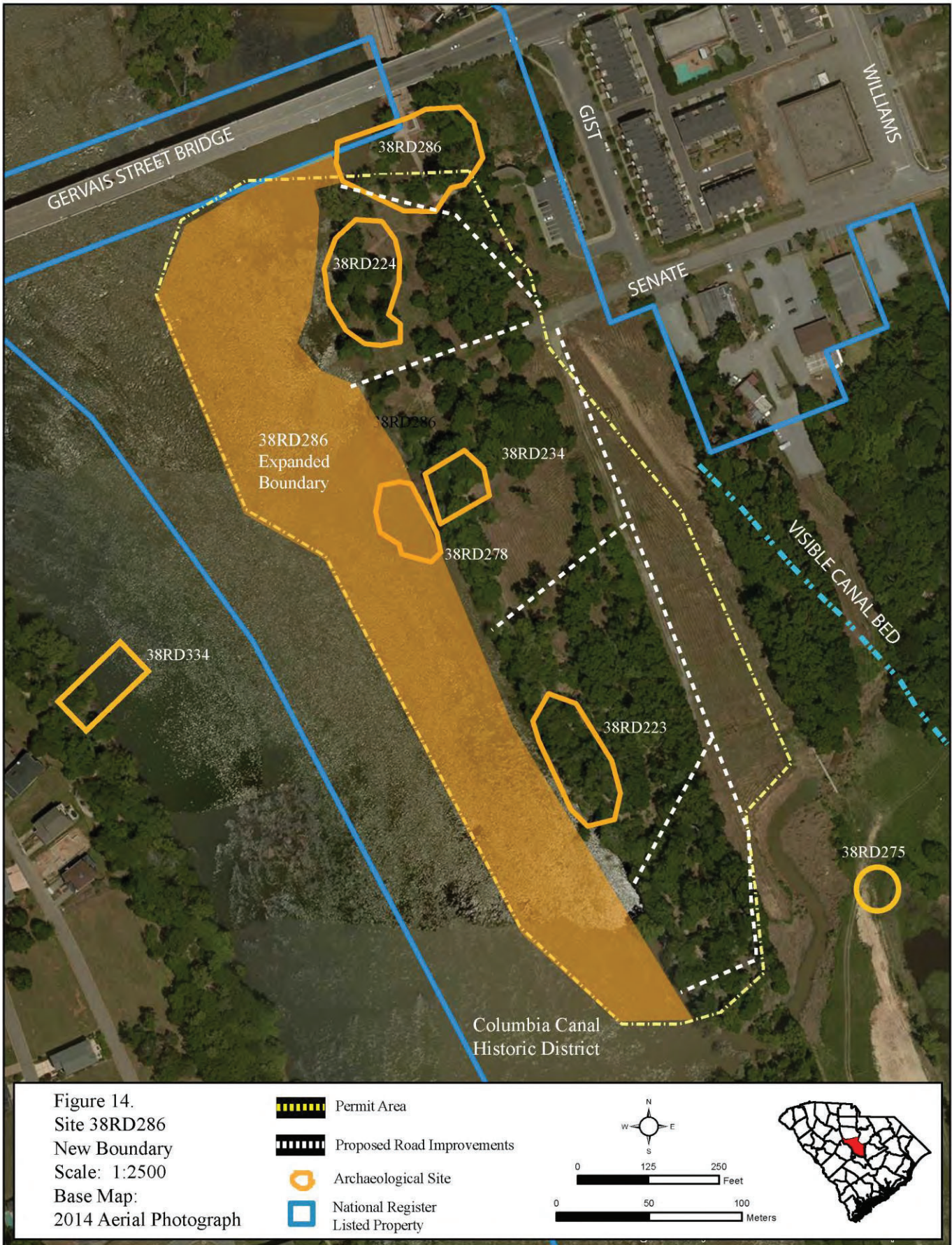

dumped into the Congaree River near the Gervais Street Bridge. According to Civil War Records:

A detail of 500 men each from the First and Second Brigades, properly officered for fatigue duty, together with the pioneer corps and fifty wagons, reported to Captain Buel, chief ordnance officer, to destroy public works, machinery, ordnance, ordnance stores, and ammunition, of which there were large quantities.

General John. E. Smith

According to General Smith it took 1200 men and 50 wagons from 1 P.M. February 18 to 6 P.M. February 19 to destroy the machinery, ordnance, ordnance stores and ammunition. Figure 15 provides a list of the ordnance captured.

Soon after Union troops departed Columbia ordnance recovery began. The accounts of J. F. Williams indicated that industrious citizens of Columbia were quick to salvage powder from the boxes of paper cartridges that had been left on the bank and for years after the war people would dive into the river and recover cannon balls and shells (Williams 1929).

Newspaper articles dating to the 1930s and more formal recovery attempts conducted in the 1970s and 1980s provide supporting evidence that Civil War ordnance is still present in the river. In June 1930, *The State* reported that two fishermen recovered ammunition from the area of a small tributary near the base of the Gervais Street Bridge. The discovery motivated New Brookland Mayor L. Hall and Councilman D. A. Spigner to organize a project to recover the artifacts. Their recovery was extensive and labor intensive. A coffer dam was erected approximately where Senate Street terminates at the river. After digging through the mud and silt the project collected six 10-inch cannonballs, 1,010 round rifle balls, 767 pointed rifle balls, a number of cast-iron copper fused explosive cannon shells; and cast iron lead butt explosive shells; three cast-iron cannon balls; one brass cap explosive, 11 3½-inch round cannon balls, 51 2-inch cannon balls; 2 6-inch cannon balls; 3 3½-inch time fuse explosive bombs; and an artillery axe (*The State* 1930). According to the article Hall and Spigner believed they had recovered practically all the ammunition that was deposited in the river. Based on the inventory presented in Figure 3, however, the 1930s recovery accounts for only a fraction of what may be present.

Eight years after the Hall and Spigner conducted their recovery, the *Spartanburg Herald* reported that two New Brookland high school boys found an artillery projectile in the Congaree River. The boys, Luther J. Morris and Knowiton Jeffcoat, apparently attempted to melt lead out of the round causing a minor explosion that brought the find to the attention of New Brookland authorities (*The Spartanburg Herald* 1938).

Beginning in the 1970s a number of formal recovery and salvage projects have been conducted at the sites. A majority of these projects have been conducted with licenses provided by the South Carolina Institute of Archaeology and Anthropology (SCIAA) under the Underwater Antiquities Act, providing a precedent for conducting the currently proposed project under a similar Salvage License. In the winter of 1976 an acoustic survey in the Congaree River below the Gervais Street Bridge was conducted to identify concentrations of ordnance and artifacts. Although conditions were not ideally suited for an acoustic survey the project identified a concentration of ferrous material below the Gervais Street Bridge (Finkelstein 1976).

Inventory of ordnance and ordnance stores captured in Columbia, S. C., February 17, 1865.

Ball cartridges (no caps).....	1, 200, 000
Percussion caps.....	100, 000
Powder..... pounds..	26, 150
12-pounder gun ammunition, fixed..... rounds..	1, 007
6-pounder gun ammunition, fixed..... do.....	3, 852
24-pounder gun ammunition, fixed..... do.....	546
8-inch shot and shell..... do.....	2, 364
10-inch shot and shell..... do.....	1, 320
Stands of arms.....	10, 410
Unfinished arms.....	6, 000
6-pounder guns.....	14
James guns.....	2
12-pounder mountain howitzers.....	5
Blakely guns.....	4
18-pounder rifled guns.....	3
Wiard gun.....	1
3-inch rifle.....	1
10-pounder guns.....	2
4-inch gun.....	1
4-inch mortars.....	2
6-inch Coehorn.....	1
Bronze guns, caliber 1½ and 2 inches.....	4
4-inch gun, smooth-bore.....	1
10-pounder Parrotts.....	2
Repeating battery.....	1
Gun carriages.....	9
Gun caissons.....	14
Gun (mountain howitzer) caissons.....	3
Forges.....	2
Anvils.....	4
Blacksmiths' vises.....	20
Sponges and rammers.....	1, 125
Sabers, cavalry, artillery, and naval.....	3, 100
Saber knots.....	700
Pairs cavalry pistol holsters.....	300
Saber belts.....	800
Bayonet scabbards.....	4, 000
Cartridge-boxes (infantry).....	5, 150
Cartridge-box plates.....	3, 500
Cartridge-box belts and plates.....	2, 500
Waist-belts.....	2, 900
Waist-belt plates.....	3, 600
Ball screws.....	2, 000
Pistol cartridge-boxes.....	550
Gunners' shot-pouches.....	600
Knapsacks.....	1, 100
Haversacks.....	900
Slow match..... yards..	500
10-inch fuses.....	900
Tents.....	58

PHILIP MacCAHILL,

Lieut. and Actg. Ordnance Officer, First Div., Fifteenth Army Corps.

Figure 15. Inventory of ordnance captured during the occupation of Columbia.

Under a salvage license issued in 1980, diver Gerald Mahle discovered a cache of 10-inch cannon balls at the site. Mahle and his team estimated that 50 to 100 additional shot lay in the river. However, by the time they were able to return to the river divers associated with the Savannah River Dive Club in Hampton, South Carolina had removed the ordnance (Salvage License No. 26 file SCIAA).

Mahle continued work under the SCIAA permit from February through September 1981. Using a dragline, a backhoe and a gold dredge, Mahle and his team removed and screened sediment from

the river bed and apparently the alluvial fan near the foot of Senate Street. Fieldwork resumed in August 1981 using the backhoe for excavation. The project recovered numerous Civil War artifacts including a 3.5-inch shell, a 24-pound cannonball, two 10-inch shells and a post-Civil War projectile. Apparently the work did not produce sufficient material to justify continuation of the project (Salvage License No. 27 file SCIAA).

In 1983 a SCIAA Salvage License was issued for a metal detecting survey in the Congaree immediately south of the Gervais Street Bridge. Recovered artifacts associated with the Armory consist of 12 explosive shot for a 6-pounder cannon and one explosive shot for a 4-pounder (Salvage License No. 30 file SCIAA). Since the 1980s there are anecdotal reports of Civil War related artifacts being discovered in the river and on the alluvial fan at the terminus of Senate Street but there have been no additional formal recoveries.

Based on this information, there is sufficient documentary and formal survey evidence to establish the continuing presence of ordnance in this section of the river. With this in mind a series of magnetometer and side scan sonar surveys were conducted in advance of the Congaree River Sediment Clean-up project to determine the possible extent of ordnance within the contaminated area.

Over a period of 18 months, from 2010 to 2012, Tidewater Atlantic Research, Inc. conducted remote sensing surveys within the course of the river and on the eastern bank (Tidewater Atlantic Research 2010, 2011a, 2011b, 2012). The first phase of this work focused on the area from the Gervais Street to approximately 1500 feet downstream. The magnetometer survey identified 218 anomalies that were consistent with unexploded ordnance (UXO). Phase II of the survey began where Phase I ended and extended another 400 feet downstream. Ten anomalies that could be could represent UXO were identified in this phase. Phase III of the survey focused on the area from Unnamed Tributary 2 to just south of the Blossom Street Bridge. One hundred and twenty-two hits consistent with potential ordnance were recorded in this phase. Phase IV was the continuation of a terrestrial metal detector survey along the river bank and alluvial fan at the end of Senate Street. An additional 67 potential instances of UXO were recorded along the shoreline. Figure 16 is a map of the location of the magnetic anomalies. Attachment A provides a summary of magnetic anomaly survey along with a map detailing the precise locations of the possible UXO.

Based on the underwater survey work the boundaries of Site 38RD286 have expanded. The site now measures 90 meters east to west by 500 meters north to south. Historic documentation clearly indicates that disposal of the ordnance was a significant event associated with the capture and burning of Columbia. Historic accounts are clear and consistent as to the location of this site. Previous underwater salvage operations have confirmed the presence of Civil War ordnance and the underwater survey has confirmed the likelihood of additional artifacts. This site is recommended Eligible for the National Register of Historic Places under Criterion A based on its association with significant events related to the Civil War and Criterion D based on its potential to yield information important to history. This site will be adversely affected by the proposed undertaking. Mitigation will be required.

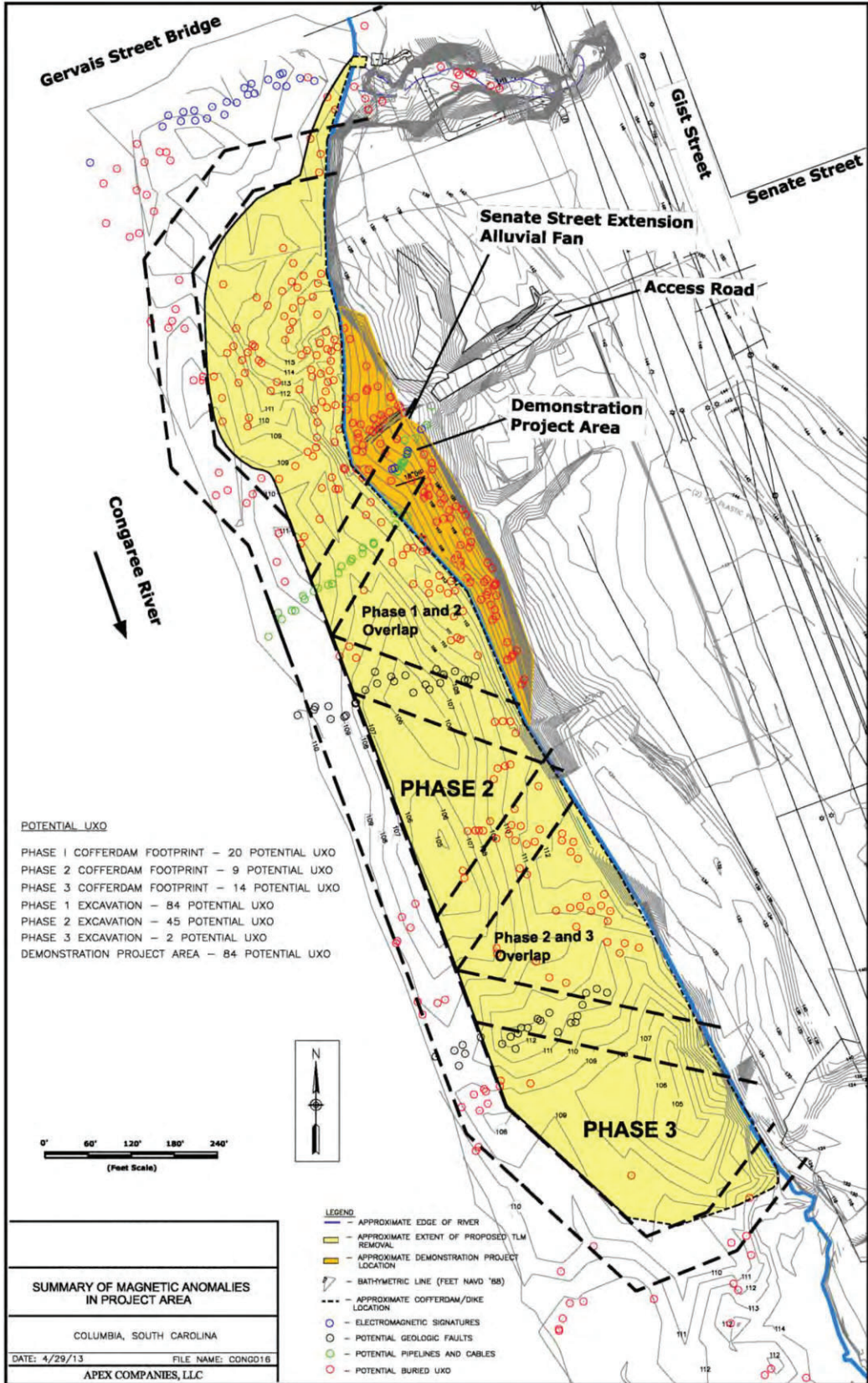

Figure 16. Locations of potential ordnance base on side magnetic anomalies.

National Register Listed Resources

New Brookland Historic District – The New Brookland District is approximately 0.25 miles west of the project area. This is a mill village constructed for the employees of the Columbia Duck Mill, the mill that was hydroelectrically powered by the Columbia Canal. A large number of commercial buildings and residences associated with the various growth phases of the mill are still present and in good condition. The mill district is screened by large trees that line the western bank of the Congaree River. The district cannot be seen from the project area (Figure 17) and will not be affected by the proposed undertaking.

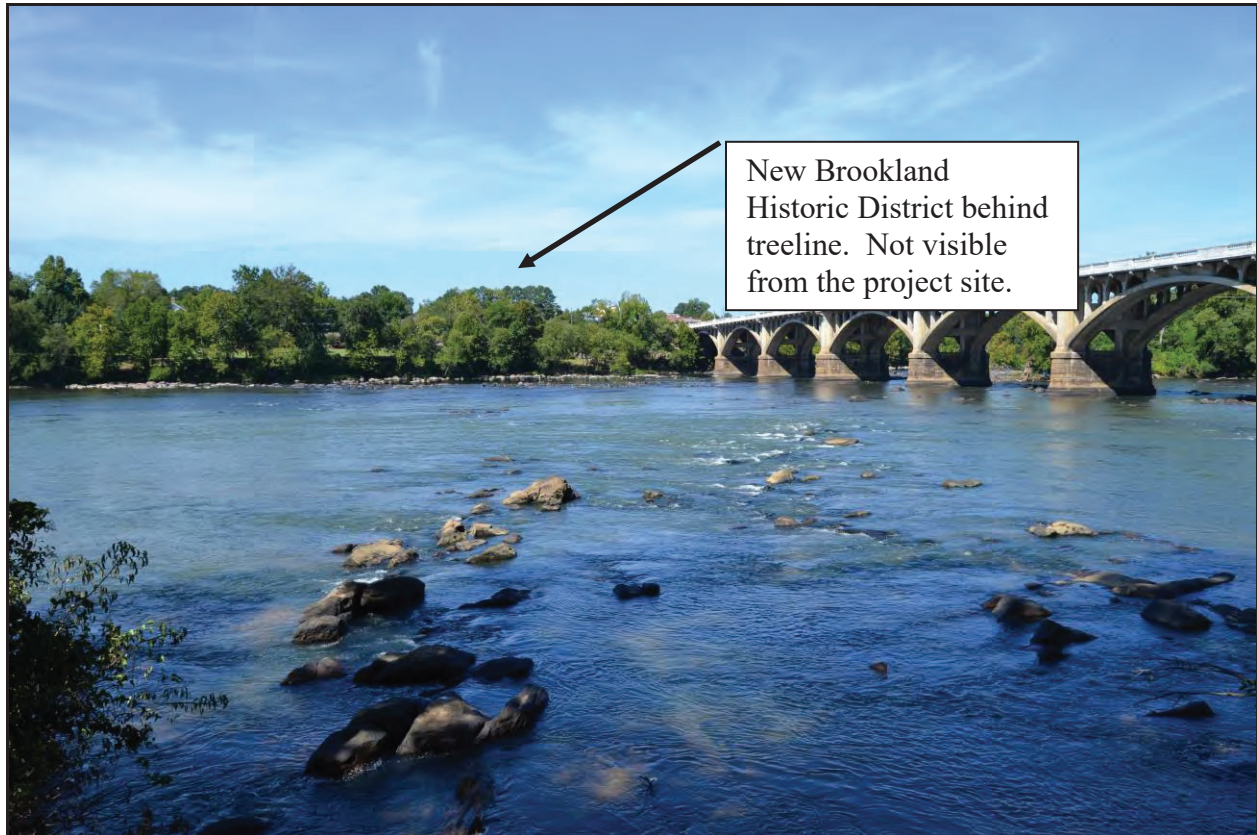

Figure 17. From the project area to the New Brookland Historic District.

Gervais Street Bridge – The Gervais Street Bridge is adjacent to the north side of the project area. Ferry crossings and bridges have historically been present in this approximate location since the 1790's. During the Union invasion of Columbia in 1865 the wooden bridge that was at this location was burned in an attempt to slow Sherman's troop advancement into the city. Another bridge was built at the same location and was owned privately until 1912 when it was purchased by Richland County (Figure 18). This bridge was demolished with completion of the current Gervais Street Bridge. Construction began on the current bridge 1926 and was completed in 1928. The 1415 foot bridge has nine open spandrel arch segments with closed arch spandrels at each end. Other than removal and repaving activities there have been no alterations to the bridge.

The bridge is one of four open spandrel arch bridges in South Carolina. It is significant for its design and its association with transportation and the growth of Columbia. It was listed on the National Register in 1978 as part of the Columbia Multiple Resource Area (National Register of Historic Places Nomination Form 1978).



Figure 18. Previous Gervais Street Bridge circa 1900 (photo courtesy of the Carolina Library).

The Congaree River Sediment Removal project proposes a temporary coffer dam immediately downstream of the the bridge. As stated previously the coffer dam will be constructed of rock/rip rap and will stand between 0 and 10 feet above the water line depending on river fluctuations. The coffer dam and the remediation project will have no effect on the design of the bridge nor will affect the bridge’s significant role in transportation. There is little remaining of any historic viewshed that may have been associated with the bridge. Billboards are present at both ends of the bridge and a large modern apartment building is located on its western side (Figure 19). Development and the skyline of downtown Columbia are also clearly visible from the bridge. The coffer dam will be a temporary construction and will provide no significant visual impact to an already compromised historic viewshed.

Columbia Canal – The Columbia Canal Historic District was listed on the National Register in 1979 under a number of areas of significance. It is considered archaeologically/historically significant based on the likelihood that excavation around intact portions of the canal could obtain detailed information on the construction of the canal bed and associated features. This information could, in turn, be compared to work done on other canals of the period. Excavation of the canal beds could also recover artifacts that would help interpret how the canal was utilized when it was active. The engineering techniques utilized in the construction of both the original 1824 canal and 1891 improvement are considered significant.

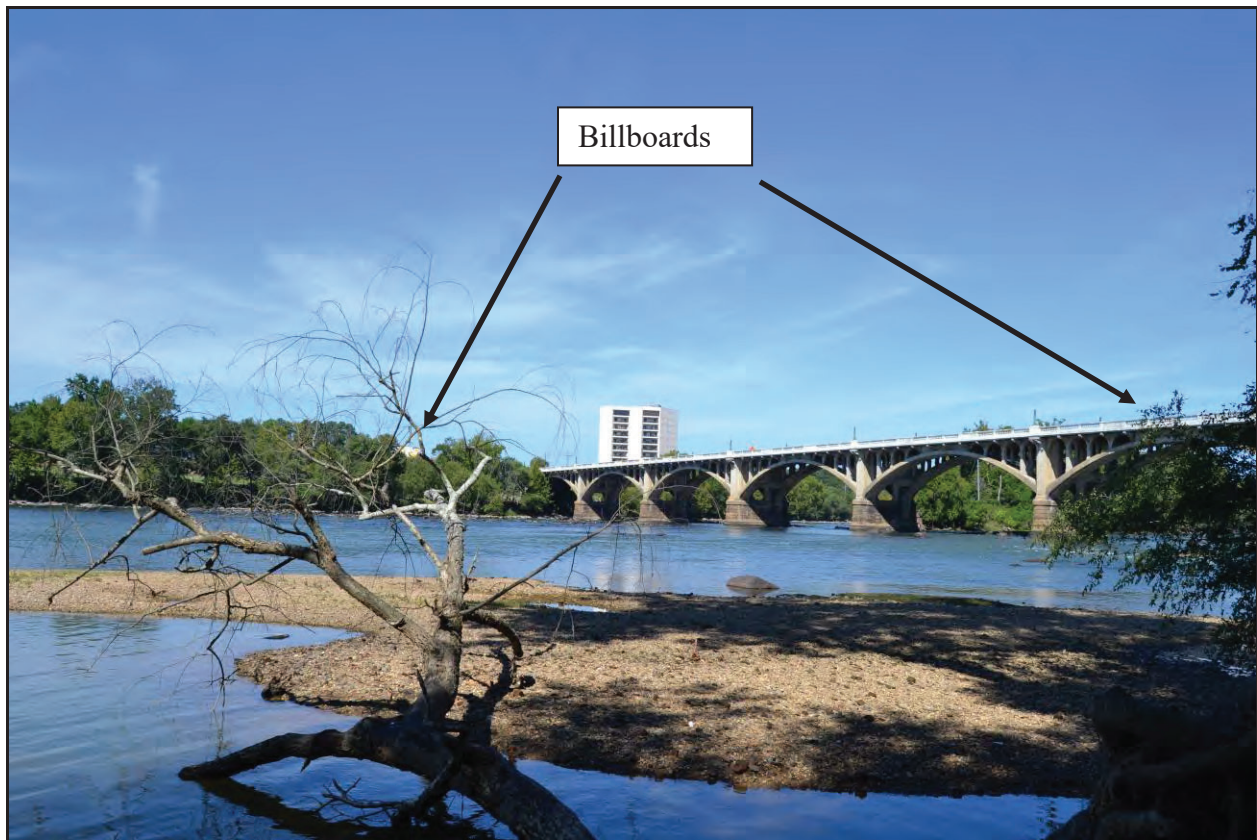

Figure 19. From project area to Gervais Street Bridge. Note modern apartment building.

The canal is also considered significant for the role it played in transportation and commerce. Because it was integral to the largest cotton shipping center in the state, the canal played a crucial role in the development of South Carolina's railroad system and the growth of Columbia. Expanding on the canal's role in commerce it was significant for its role in advancing industry in the state. From supporting ancillary small industries such as saw and grist mills to eventually becoming a valuable power source to larger mills the canal supported industry in Columbia. Finally the canal is considered significant under the category of "invention". In 1894 a large textile mill became the first in the country to use electrically generated power directly from a canal over a distance rather than an on-site power system like a waterwheel.

The original canal was constructed between 1820 and 1824. It was initially intended as a means of circumventing the unnavigable confluence of the Broad and Saluda rivers. This canal was over three miles long. It began above Richland Street on the Broad River and ended at Granby Ferry south of the project area. It had five turning basins with the largest being at the south end of Senate Street just north of the project tract. North of the Senate Street Turning Basin the canal was 12 feet wide and contained two and half feet of water. South of Senate Street, in the vicinity of the project area, the canal was 18 feet, contained four feet of water and was flanked by eight foot wide tow paths (Nomination Form 1978). With the increasing reliance on the railroad for shipping the 1824 canal was gradually allowed to deteriorate and by 1842 was used primarily to power waterwheels for mill sites rather than transport goods. Its route is visible on Russell's 1850 map of Columbia (Figure 20) and the 1870 Tingle map of the Columbia Canal (Figure 21).

In 1888 the Board of Trustees for the Columbia Canal approved a plan to develop the portion of the canal north of Gervais Street into a new power source for the city. This project involved widening the canal to 150 feet across and dredging it to a depth of 10 feet (Wilbur Smith and Associates 1979). The expanded canal was completed on November 21, 1891. Power houses and the associated Hydro Plant used for generating electricity for the Duck Mill opened up north of Gervais Street. South of Gervais the canal was abandoned.



Figure 20. Location of the Canal bed in relation to the project area in 1850.

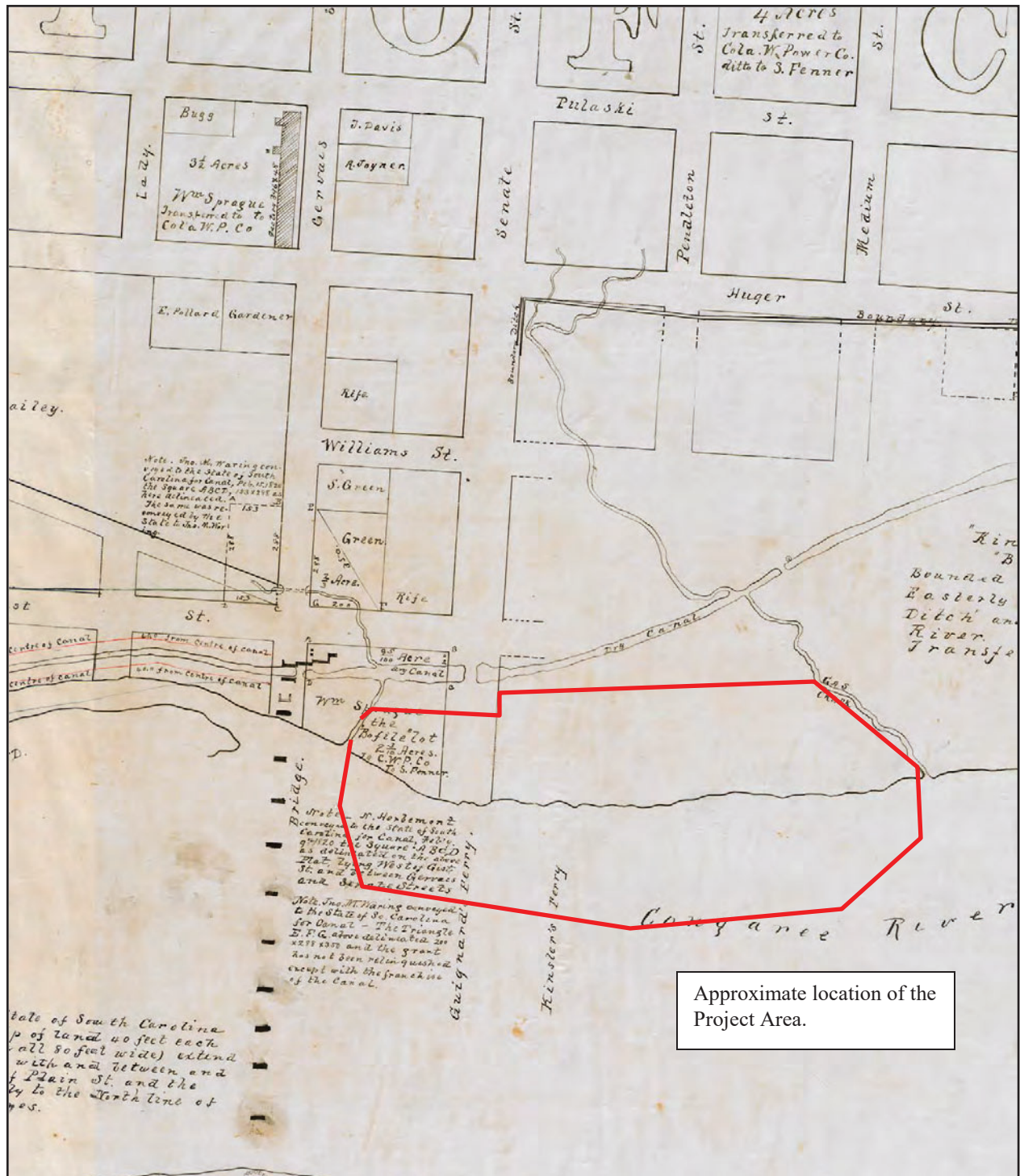

Figure 21. Location of the canal bed in relation to the project area in 1870.

The Hydro Plant was built in 1896. It furnished electricity for lights in the city of Columbia, as well as supplied current for public and private manufacturing and the Street Railway System. The plant is still operational and provides a large portion of power for the city. While the internal workings of the Hydro Plant have been updated and modified to meet today's demand for electricity the building itself remains much as it was when it was first built. It is a brick

structure with symmetrical arches that allow the canal to flow back into the river. The plant can be seen from the northern edge of the project area (Figure 22).



Figure 22. View from project location to Canal Hydro Plant, facing north.

The plant is part of the Columbia Canal Historic District and adds to the district's significant contribution to Industry and Invention. The proposed coffer dam will not affect those areas of significance. The historic viewshed of the Hydro Plant will also not be affected by the proposed undertaking.

The temporary coffer dam will be similar in appearance to the existing rip rap and stone embankment that currently abuts the Hydro Plant (Figure 23). The coffer dam will in fact be similar in construction to the canal itself. Canouts and Harmon (1981) note that an 1867 profile drawing shows the canal banks as rip rap along the river's edge. They also indicate that the 1891 canal had rip rap placed along erosional areas. Additionally there are numerous modern intrusions to the Hydro Plant's viewshed. The Edventure Children's Museum with its modern three story glass façade is adjacent to the plant compromising the historic integrity of Canal District (Figure 24). The proposed project will have no impact on the visual landscape of the Columbia Canal Historic District.



Figure 23. View from Columbia Canal Hydro Plant to project area. Note rip rap.



Figure 24. Example of modern buildings adjacent to the Canal Hydro Plant.

V. SUMMARY AND RECOMMENDATIONS

Five archaeological sites and three National Register Listed properties/districts were identified within or adjacent to the permit area. A background study and pedestrian survey were employed to determine if the proposed project would have any effect on significant cultural resources.

Project plans have been designed to avoid impacts to archaeological sites 38RD223, 38RD224 and 38RD234. These are upland, terrestrial sites that fall within the permit area. These sites were identified 33 years ago during a reconnaissance survey. At the time they were recorded all three sites had clearly visible, above ground components. In the intervening years periodic land clearing and maintenance appear to have displaced and removed the structural ruins associated with 38RD224 and 38RD234. Modern dumping has obscured the historic nature of the late nineteenth to early twentieth century bottle dump at 38RD223. These three sites potentially have intact subsurface deposits. Avoidance of these sites is recommended as they have not been evaluated for the NRHP. Monitoring is recommended during construction activities in the vicinity of these sites to ensure that no significant cultural deposits be impacted.

There are two underwater archaeological sites that were previously recorded in the project area. 38RD278 is a small scatter of historic and prehistoric artifacts. The historic artifacts may be associated with the historic structure recorded as site 38RD234. This site was not evaluated for the NRHP. It will be adversely impacted by the proposed undertaking. Site 38RD286 is the location where Union troops dumped ordnance from the Palmetto Armory during the capture and burning of Columbia. Recent magnetometer and side-scan SONAR surveys have led to an expansion of the boundary of this site. The site now measures 90 by 500 meters and encompasses site 38RD278. 38RD278 is effectively a component of the ordnance dump site. Historic accounts, past salvage operations and recent underwater survey work have led to the recommendation that this site is eligible for the NRHP. If this site cannot be avoided additional archaeological work will be required to mitigate the adverse effects of the Congaree Sediment Removal Project.

The project area is within the Columbia Canal Historic District. The project will not affect the integrity or National Register significance of the district nor will affect any individual components of the district such as the extant canal bed and the Columbia Canal Hydro Plant.

The Gervais Street Bridge is adjacent to the project area. The bridge is significant for its contribution to transportation and for its design. The project will cause no alteration to the bridge's design nor affect its role in transportation. The bridge is flanked by the City of Columbia to the east and Cayce to the west. The modern skyline associated with this metropolitan area is clearly visible from the bridge. The proposed project will have no effect on the viewshed of the bridge.

The New Brookland Historic District is across the river from the project area. This is a mill village for its intact architectural elements and its association with the Columbia Duck Mill, the mill that was hydroelectrically powered by the Columbia Canal. The project will be screened by large trees along the river banks and will have no effect on the significant elements of this district.

REFERENCES

- Anderson, David G.
1985 Middle Woodland Societies in the Lower South Atlantic Slope: A View from Georgia and South Carolina. *Early Georgia* 13(1-2):29–66.
- 1995 Paleoindian Interaction Networks in the Eastern Woodlands. *Native American Interactions: Multiscalar Analyses and Interpretations in the Eastern Woodlands*, edited by Michael S. Nassaney and Kenneth E. Sassaman, in press. University of Tennessee Press, Knoxville.
- Anderson, David G., and J. Joseph
1988 *Richard B. Russell Reservoir Technical Synthesis of Cultural Resource Investigations*. Russell Papers. TRC Garrow Associates, Inc., and Interagency Archaeological Services, National Park Service, Atlanta.
- Anderson, David G., R. Jerald Ledbetter, and Lisa D. O’Steen
1990 *Paleoindian Period Archaeology of Georgia*. Georgia Archaeological Research Design Paper No. 6. University of Georgia, Athens.
- Anderson, David G., Lisa D. O’Steen, and Kenneth E. Sassaman
1996 Environmental and Chronological Considerations. In *The Paleoindian and Early Archaic Southeast*, edited by David G. Anderson and Kenneth E. Sassaman, pp. 3-15. The University of Alabama Press, Tuscaloosa.
- Anderson, David G., Kenneth E. Sassaman, Christopher Judge (editors)
1992 *Paleoindian and Early Archaic Period Research in the Lower Southeast: A South Carolina Perspective*. Council of South Carolina Professional Archaeologists in conjunction with Savannah River Archaeological Research Program, South Carolina Institute of Archaeology and Anthropology, University of South Carolina, Columbia.
- Anderson, David G., and Joseph Schuldenrein (assemblers)
1985 *Prehistoric Human Ecology Along the Upper Savannah River: Excavations at the Rucker's Bottom, Abbeville and Bullard Site Groups*. 2 vols. Gilbert/Commonwealth Associates, Inc., Jackson, Michigan. Submitted to National Park Service, Archeological Services Branch, Atlanta.
- Blanton, Dennis B., and Kenneth E. Sassaman
1989 Pattern and Process in the Middle Archaic Period in South Carolina. In *Studies of South Carolina Archaeology*, edited by Albert C. Goodyear III and Glen T. Hanson, pp. 53–72. University of South Carolina Institute of Archaeology and Anthropology, Anthropological Studies No. 9. Columbia.
- Braun, E.L.
1950 *The Deciduous Forests of Eastern North America*. Philadelphia, Blakiston.

- Bryson, Reid A., David A. Baerreis, and W. M. Wendland
 1970 The Character of the Late Glacial and Post Glacial Climatic Changes. In *Pleistocene and Recent Environments of the Central Great Plains*, edited by W. Dort, Jr., and J. K. Jones, Jr., pp. 53–74. University of Kansas Special Publications 3.
- Bullen, Ripley P., and H. B. Greene
 1970 Stratigraphic Tests at Stallings Island, Georgia. *Florida Anthropologist* 23:8–28.
- Canouts, Veletta and Michael Harmon
 1981 *Where the Waters Meet: An Archaeological Study of the Columbia Canal Historic District*. Institute of Archaeology and Anthropology, University of South Carolina, Columbia.
- Central Midlands Regional Planning Council (CMRPC)
 1982 Town of Lexington and Unincorporated Lexington County, S.C. Historic Resources (Multiple Resource National Register Nomination). On file, South Carolina Department of Archives and History, Columbia.
- Daniel, I. Randolph, Jr.
 1996 *Hardaway Revisited: Early Archaic Settlement in the Southeast*. University of Alabama Press, Tuscaloosa.
 1998 Stone Raw Material Availability and Early Archaic Settlements in the Southeastern United States. *American Antiquity* 66(2):237–265.
- Delcourt, P. A., and H. A. Delcourt
 1983 Late Quaternary Vegetational Dynamics and Community Stability Reconsidered. *Quaternary Research* 19:265–271.
- Edgar, Walter
 1998 *South Carolina: A History*. University of South Carolina Press, Columbia.
- Elliott, Daniel T., and Roy Doyon
 1981 *Archaeology and Historical Geography of the Savannah River Floodplain Near Augusta, Georgia*. Series Report No. 22. Laboratory of Archaeology, University of Georgia, Athens.
- Ferguson, Leland G.
 1971 *South Appalachian Mississippian*. Ph.D. dissertation, Department of Anthropology, University of North Carolina, Chapel Hill.
- Ford, Lacy K Jr.
 1988 *Origins of Southern Radicalism: The South Carolina Upcountry, 1800–1860*. Oxford University Press, New York.
- Goodyear, Albert C.
 1999 *A Hypothesis for the Use of Cryptocrystalline Raw Materials Among Paleo-Indian Groups of North America*. The University of South Carolina Institute of Archaeology and Anthropology Research Manuscript Series 156. Columbia.
- Green, William, and James Bates
 2003 The Broad River Chiefdom: A Possible Unrecognized Chiefdom in the Central South Carolina Piedmont. Paper presented at the Southeastern Archaeological Conference, Charlotte.

- Justice, Noel D.
1987 Stone Age Spear and Arrow Points of the Midcontinental and Eastern United States. Indiana University Press, Bloomington.
- Kennedy, Joseph C. G. (compiler)
1990 *Population of the United States in 1860; Compiled from the Original Returns of the Eighth Census under the Direction of the Secretary of the Interior*. Reprinted. Norman Publishing, Inc., New York. Originally published in 1865, Government Printing Office, Washington, D.C.
- Kovacik, Charles F., and John J. Winberry
1987 *South Carolina: The Making of a Landscape*. University of South Carolina Press, Columbia.
- Lansdell, Brent
2003 *Assessment of Known and Potential Archaeological Sites in the Saluda Dam Remediation Project at Lake Murray, Lexington, Newberry, Richland and Saluda Counties, South Carolina*. Brockington and Associates, Inc., Atlanta and Columbia. Submitted to South Carolina Electric and Gas, Columbia, South Carolina.
- Michie, James L.
1996 The Taylor Site: An Early Occupation in Central South Carolina. In *The Paleoindian and Early Archaic Southeast*, edited by David G. Anderson and Kenneth E. Sassaman, pp. 238-269. The University of Alabama Press, Tuscaloosa.
- Milanich, Jerald T. and Charles H. Fairbanks
1980 *Florida Archaeology*. Academic Press, New York.
- Mills, Robert
1980 *Atlas of the State of South Carolina*. Baltimore: F. Lucas, Jr., 1825. Reprint. Southern Historical Press, Inc., Greenville, South Carolina.
- Moore, John Hammond
1993 *Columbia & Richland County: A South Carolina Community, 1740–1990*. University of South Carolina Press, Columbia.
- National Register of Historic Places Nomination Form
1978 The Columbia Canal. Prepared by Charles E. Lee, South Carolina State Historic Preservation Officer.
1978 Columbia Multiple Resource Area. Prepared by Charles E. Lee, South Carolina State Historic Preservation Officer.
- O’Steen, Lisa D.
1993 *Early Archaic Settlement Patterns in the Wallace Reservoir: An Inner Piedmont Perspective*. Unpublished Master’s thesis, Department of Anthropology, University of Georgia, Athens.
- O’Steen, Lisa D., R. Jerald Ledbetter, Daniel T. Elliott, and William W. Barker
1986 Paleo-Indian Sites of the Inner Piedmont of Georgia: Observations of Settlement in the Oconee Watershed. *Early Georgia* 14(1, 2):1–63.

Pope, Thomas H

1973 *The History of Newberry County, Vols. I and 2*. Columbia: University of South Carolina Press.

Salley, A.S.

1892 *The History of Orangeburg County South Carolina From its First Settlement to the Close of the Revolutionary War*. Regional Publishing Company, Baltimore.

Sassaman, Kenneth E.

1985 A Preliminary Typological Assessment of MALA Hafted Bifaces from the Pen Point Site, Barnwell County, South Carolina. *South Carolina Antiquities* 17:1–17.

1993a Mims Point 1992: Archaeological Investigations at a Prehistoric Habitation Site in the Sumter National Forest, South Carolina. *Savannah River Archaeological Research Papers* 4. Occasional Papers of the Savannah River Archaeological Research Program, South Carolina Institute of Archaeology and Anthropology, University of South Carolina, Columbia.

1993b *Early Pottery in the Southeast*. University of Alabama Press, Tuscaloosa.

1996 Technological Innovations in Economic and Social Contexts. In *Archaeology of the Mid-*

Smith, Marvin T.

1983 *Depopulation and Culture Change in the Early Historic Period Interior Southeast*. Ph.D. dissertation, Department of Anthropology, University of Florida, Gainesville.

Tidewater Atlantic Research, Inc

2010 *A Remote-Sensing Survey of the Congaree River Below the Gervais Street Bridge*. Submitted to Management and Technical Resources, Inc. Tidewater Atlantic Research. Wilmington, NC.

2011a *A Remote-Sensing Survey of the Congaree River Below the Gervais Street Bridge, Phase II Addition*. Submitted to Management and Technical Resources, Inc. Tidewater Atlantic Research. Wilmington, NC.

2011b *A Remote-Sensing Survey of the Congaree River Below the Gervais Street Bridge, Phase III Report*. Submitted to Management and Technical Resources, Inc. Tidewater Atlantic Research. Wilmington, NC.

2012 *A Terrestrial Remote-Sensing Survey of the Congaree River Below the Gervais Street Bridge*. Submitted to Management and Technical Resources, Inc. Tidewater Atlantic Research. Wilmington, NC.

Trimble, Stanley W.

1974 *Man-Induced Soil Erosion on the Southern Piedmont, 1700–1970*. Soil Conservation Society of America, Ankeny, Iowa.

Trinkley, Michael

1985 Ceramics of the Central South Carolina Coast. *South Carolina Antiquities* 12:1–35.

Ward, H. Trawick

- 1983 A Review of Archaeology in the North Carolina Piedmont: A Study of Change. In *Prehistory of North Carolina: An Archaeological Symposium*, edited by Mark Mathis and Jeffery Crow, pp. 53-81. Raleigh: Department of Cultural Resources, North Carolina Division of Archives and History.

Watts, W. A.

- 1975 *Vegetation Record for the Past 20,000 Years from a Small Marsh on Lookout Mountain, Northwestern Georgia*. Geologic Society of America Bulletin 86.

Wharton, Charles H.

- 1977 *The Natural Environments of Georgia*. Georgia Department of Natural Resources, Atlanta.

Whatley, John, Jr.

- 1985 The Possible Extension of the Paris Island Stemmed Point to the Georgia Coastal Plain. *The Profile* 47:11-13.

Whitehead, Donald R.

- 1973 Late-Wisconsin Vegetational Changes in Unglaciaded Eastern North America. *Quaternary Research* 3:621-631.

Wilbur Smith and Associates

- 1979 *The Columbia Canal Study*. Wilbur Smith and Associates, Columbia.

ATTACHEMENT 1 – ANOMALY SUMMARY

DRAFT

Congaree River Anomaly Summary Congaree River Project Columbia, SC

Site Location

The report summarizes the results of the magnetometer surveying activities conducted in support of the South Carolina Electric and Gas (SCE&G) Company Congaree River Project located in Columbia, SC. The Congaree River begins at the confluence of the Saluda River and the Broad River in Columbia, SC. The portion of the Congaree relevant to this project is the approximate eastern third of the river beginning directly south of the Gervais Street Bridge and extending for approximately 3,700 feet downstream to approximately 500 feet below the Blossom Street Bridge. Figure 1 provides the location of the area in question.

Background Information

In June 2010, the South Carolina Department of Health and Environmental Control (SCDHEC) noted tar-like material (TLM) near the eastern shoreline of the Congaree River directly downstream of the Gervais Street Bridge. SCDHEC collected samples of this material and the analytical results indicated that the source of the TLM might be attributable to the former manufactured gas plants (MGP) that operated in Columbia starting in the mid-1800s and ending in the late 1940's to early 1950's. Predecessor companies of SCE&G operated the Huger Street manufactured gas plant (Huger Street MGP). Its location is provided on Figure 1. SCE&G has recently completed a removal action at the Huger Street site where over 125,000 tons of MGP impacted soil and debris was excavated and removed with oversight provided by SCDHEC.

SCE&G submitted a Project Delineation Report (PDR) [MTR, March 2012] to SCDHEC on March 23, 2012. SCDHEC approved the PDR on April 23, 2012. The PDR presented the results of delineation activities completed to determine the extent of the TLM within the river. The delineation work was completed in five separate phases over approximately 18 months. The magnetometer surveying operations described in this summary report were a component of the investigative activities and were necessary due to the potential presence of Civil War era explosive ordnance within the project area. Details pertaining to the ordnance are provided below.

Potential Presence of Historical Items and Unexploded Ordnance (UXO)

It has been confirmed that in 1865, during the Civil War, live munitions and other articles of war produced by the Confederacy were dumped into the Congaree River near the Gervais Street Bridge by Union forces under the direction of General Sherman. This activity took place during Sherman's occupation and subsequent destruction of Columbia. A list of munitions and other Confederate items captured by the Union forces is provided in Attachment A. The Union Army kept some of these items for its own use and the remainder was destroyed. One of the methods for destruction was dumping the items into the river.

Archeological investigations, conducted as late as 1980, recovered some live and unstable munitions or unexploded ordnance (UXO) from the area as well as some other potentially historically significant artifacts. Specifically this work was focused in and adjacent to the unnamed tributary that enters the river just south of the Gervais Street Bridge. Figure 2 shows this location and a daily activity log documenting some of the archeological work is provided in the initial Tidewater Atlantic Research Inc. report (Attachment B). Several live cannonballs were identified during this operation and properly disposed of by trained explosive ordnance disposal (EOD) personnel located at nearby Fort Jackson.

Due to the potential presence of live munitions within the project area, an additional reconnaissance and screening of the area in question was conducted as part of the investigative activities. Acoustic (side scan sonar) and magnetic (magnetometer) remote sensing surveying activities were completed in order to determine if potential munitions were present prior to conducting the sediment sampling activities. A description of these activities and their subsequent results are provided below.

Surveying Activities

Magnetometer surveying of the project area was conducted over four separate phases. The first phase was focused on the area directly downstream of the Gervais Street Bridge (grid lines 1 through 16 on Figure 2) and included some limited shoreline surveying near the Senate Street Extension Alluvial Fan (Figure 2). A sidescan sonar survey was also performed during Phase I. The purpose of the side scan sonar was to complement the magnetometer survey by potentially visually identifying objects (e.g., ordnance) that may be lying on the Congaree River bottom. The sidescan sonar survey results were inconclusive and it was not utilized in the subsequent phases.

Magnetometer surveying progressed downstream in conjunction with the continuing investigation activities with Phase II extending the survey area from grid line 16 to grid line 20. Survey of the unnamed tributary that is located south of the Gervais Street Bridge was also conducted during Phase II. Phase III encompassed the portions of the project area between grid lines 20 and 37 and Phase IV completed the shoreline surveying in the vicinity of the Senate Street Extension Alluvial Fan that was not conducted during the other phases due to access constraints.

The specific details pertaining to the surveying equipment and methodology are provided in the phase specific reports produced by Tidewater Atlantic Research Inc. provided in Attachment B. In general, depending on the area to be surveyed and the presence of rock outcrops and water level conditions, either a small boat with an outboard motor or an inflatable boat was utilized to carry the surveying equipment. The inflatable boat was pushed through areas where water levels and the presence of rocks precluded the use of the motorboat. Terrestrial surveying was done on foot with handheld and backpack mounted equipment.

The magnetometer surveys were generally run on north-south trending lines and were controlled via a differential global positioning system (DGPS) using a Trimble AgCPS 132 navigation system. HYPACK navigation software was used to translate the DGPS data into real-time data that was used to direct the survey along a predetermined grid or transects. In general, the magnetometer transects lines were located approximately 20 feet apart. In some areas of the river where obstructions were encountered and navigation had to be altered, the distance between the transect lines varied and could be decreased to less than 10 feet.

The magnetometer survey was performed with an EG&G Geometrics G-858 cesium magnetometer that is capable of +/- 0.001 gamma resolution. The magnetic data was collected at a frequency of six samples per second. The locations of the magnetic readings were determined from the DGPS.

The side scan sonar survey was performed from approximately the 4 to 16 Lines and boulders and shallow water prevented performing the survey above the 4 Line. A 445/900 kHz Klein System 3900 digital side scan sonar was employed. The side scan sonar data was horizontally tied to the DGPS and reconciled with the HYPACK survey software. Where navigation was possible, a total of five side scan sonar survey passes were made on a 50-foot transect spacing.

The magnetometer detects changes in earth's magnetic field that may be attributed to buried anthropogenic influences (e.g., UXOs, electrical cables, etc.) or naturally occurring geologic features (e.g., remnant thermal magnetism, ore bodies, etc.). Once the magnetometer data was collected it was systematically analyzed to identify potential targets. A variety of characteristics of the targets including configuration, areal extent, intensity and contrast with background were analyzed and compared to signature characteristics previously found to be reliable indicators of historic ordnance. The results are discussed below.

Results

Following each phase of fieldwork the accumulated data was analyzed and the potential UXO locations were identified. Table 1 provides the results of the magnetometer surveying activities by investigation phase and Figure 3 provides the anomaly locations for the project area. Each phase is also described in more detail in the phase specific reports provided in Attachment B. Table 2 provides a summary of the anomaly locations and interpretation and Table 3 provides a summary of the anomalies located within the planned project area and located in the planned cofferdam footprint.

As the historical and anecdotal evidence suggested, the majority of anomalies were located in the Phase I survey area nearest the Gervais Street Bridge and the boat apron. A total of 323 anomalies were detected in the Phase I area with 218 of those locations exhibiting signature characteristics that could be associated with ordnance. Some of the non-ordnance anomalies included discarded debris and appliances, an electrical cable crossing and a geologic feature.

Phase II produced 10 potential UXOs in grid lines 16 through 20 and an additional 8 in the unnamed tributary. For Phase III the number of anomalies continued to be relatively low from grid line 20 to 31 but increased directly downstream of the Blossom Street Bridge. This increase can be potentially attributable to more recent objects being thrown from the bridge and not necessarily historical UXO. The total number of targets for Phase III was 145 with 121 exhibiting signature characteristics that could be associated with ordnance.

Finally, Phase IV was conducted to obtain information in the area directly downstream of the boat apron, which was not completed during Phase I due to access constraints. A total of 84 anomalies were detected with 67 exhibiting signature characteristics that could be associated with ordnance. The total for all four phases of magnetometer surveying is 570 anomalies located within the investigated area with 425 or 75 percent of those potentially being ordnance.

Due to the nature of the potential historical objects and UXO deposited within the study area and their real or perceived value and/or potential hazard to public safety, the information contained in this summary report must remain confidential. This information was compiled by SCANA for use during completion of the investigative and subsequent remedial activities associated with the Congaree River Project. Any use or dissemination of the information for other purposes is not permitted and may be subject to legal action.

TABLE 1

MAGNETOMETER STUDY RESULTS SUMMARY

Congaree River Sediments
Columbia, South Carolina

Study	Dates	Study Area	Total Magnetic Anomalies	Potential Ordnance (UXO)	Other Anomalies
Phase I	Aug. 25-26, 2010	Congaree River - Grid Lines: 1 thru 16	323	218	105
Phase II	Jan. 4-5, 2011	Congaree River - Grid Lines: 16 thru 20 Unnamed Tributary #1 - Outfall to River	10 8	10 8	0 0
Phase III	June 30, 2011	Congaree River - Grid Lines: 20 thru 37	145	122	23
Phase IV	January 31 - February 2, 2012	Senate Street Extension / Alluvial Fan Area	84	67	17
			Total Anomalies	425	145
			Percentage with UXO Potential	75%	

Notes:

1. All magnetometer work was completed by Tidewater Atlantic Research, Inc of Washington, North Carolina.
2. Magnetic Anomalies - As determined by Tidewater by the magnetic, remote-sensing survey.
3. UXO - Unexploded Ordnance
4. UXO Potential - Referring to Magnetic Anomalies that "have signature characteristics that could be associated with ordnance" and "those anomalies should be considered potentially hazardous until material generating the signatures can be identified".
5. Other - Other magnetic anomalies include pipelines, geologic features, modern debris etc.

TABLE 2

MAGNETIC ANOMALY LOCATION AND INTERPRETATION

Congaree River Sediments
Columbia, South Carolina

Designation	Characteristics	Potential Interpretation
1	078-1-nm262g175f	Geological Feature
2	078-2-dp280g49f	Pipeline
3	078-3-mc48g59f	Possible Ordnance
4	078-5-mc1854g71f	Possible Ordnance
5	077-1-nm758g34f	Possible Ordnance
6	077-2-mc40g45f	Possible Ordnance
7	077-3-mc52g76f	Possible Ordnance
8	077-4-pm203g68f	Pipeline
9	077-5-pm320g176f	Geological Feature
10	077-6-30g18f	Possible Ordnance
11	077-7-dp57g58f	Possible Ordnance
12	077-8-dp63g83f	Geological Feature
13	077-9-mc149g71f	Possible Ordnance
14	076-1-pm130g44f	Possible Ordnance
15	076-2-pm137g288f	Possible Ordnance
16	076-3-nm31g37f	Possible Ordnance
17	076-4-nm34g49f	Possible Ordnance
18	076-5-pm307g190f	Geological Feature
19	076-6-pm510g66f	Pipeline
20	076-7-mc76g69f	Possible Ordnance
21	076-8-mc627g66f	Possible Ordnance
22	075-1-dp116g50f	Possible Ordnance
23	075-2nm18g40f	Possible Ordnance
24	075-3-dp52g65f	Possible Ordnance
25	075-4-dp70g65f	Possible Ordnance
26	075-5-pm301g60f	Pipeline
27	075-5-pm289g178f	Geological Feature
28	075-7-dp36g30f	Possible Ordnance
29	075-8-nm59g80f	Possible Ordnance
30	075-9-pm48g35f	Geological Feature
31	075-10-pm125g70f	Possible Ordnance
32	074-1-dp207g40f	Possible Ordnance
33	074-2-dp121g40f	Geological Feature
34	074-3-pm32g20f	Possible Ordnance
35	074-4-pm288g215f	Geological Feature
36	074-5-nm861g50f	Pipeline
37	074-6-pm27g20f	Possible Ordnance
38	074-7-dp42g40f	Possible Ordnance
39	074-8-dp71g65f	Possible Ordnance
40	074-9-nm58g90f	Possible Ordnance
41	073-1-nm36g22f	Possible Ordnance
42	073-2-nm21g30f	Possible Ordnance
43	073-3-dp21g40f	Possible Ordnance
44	073-4-dp149g65f	Possible Ordnance
45	073-5-dp527g60f	Pipeline
46	073-6-pm302g199f	Geological Feature
47	073-7-pm41g18f	Possible Ordnance
48	073-8-nm60g70f	Possible Ordnance
49	073-9-dp64g31f	Geological Feature
50	073-10-dp42g17f	Possible Ordnance
51	072-1-pm46g11f	Possible Ordnance
52	072-2-pm88g23f	Geological Feature
53	072-3-pm310g167f	Geological Feature
54	072-4-pm2310g36f	Pipeline

TABLE 2

MAGNETIC ANOMALY LOCATION AND INTERPRETATION

**Congaree River Sediments
Columbia, South Carolina**

Designation	Characteristics	Potential Interpretation
55	072-5-dp62g49'	Possible Ordnance
56	071-1-nm28g10f	Possible Ordnance
57	071-2-pm46g62f	Possible Ordnance
58	071-3-pm170g55f	Possible Ordnance
59	071-4-dp494g96f	Pipeline
60	071-5-pm324g202f	Geological Feature
61	071-6-pm117g97f	Geological Feature
62	071-7-pm70g33f	Possible Ordnance
63	070-1-pm66g25f	Possible Ordnance
64	070-2-pm251g132f	Geological Feature
65	070-3-dp235g21f	Possible Ordnance
66	070-4-nm549g33f	Pipeline
67	070-5-pm159g46f	Possible Ordnance
68	070-6-nm36g18f	Possible Ordnance
69	070-7-dp48g55f	Possible Ordnance
70	070-8-nm44g15f	Possible Ordnance
71	069-1-dp23g10f	Possible Ordnance
72	069-2-dp78g44f	Possible Ordnance
73	069-3-nm1841g50f	Pipeline
74	069-4-dp252g53f	Possible Ordnance
75	069-5-pm214g155f	Geological Feature
76	069-6-pm63g17f	Geological Feature
77	068-1-pm72g94f	Geological Feature
78	068-2-dp238g167f	Possible Ordnance
79	068-3-nm402g55f	Pipeline
80	068-4-dp38g40f	Possible Ordnance
81	067-1-dp32g38f	Possible Ordnance
82	067-2-mc181g93f	Pipeline
83	067-3-pm221g300f	Geological Feature
84	067-5-mc68g90f	Geological Feature
85	067-6-dp22g30f	Possible Ordnance
86	066-1-dp61g40f	Geological Feature
87	066-2-pm182g193f	Geological Feature
88	066-3-nm190g95f	Pipeline
89	066-4-dp127g77f	Possible Ordnance
90	066-5-dp48g18f	Possible Ordnance
91	066-6-nm43g42f	Possible Ordnance
92	066-7-pm27g10f	Possible Ordnance
93	066-8-dp9g10f	Possible Ordnance
94	065-1-dp143g31f	Possible Ordnance
95	065-2-nm19g10f	Possible Ordnance
96	065-3-pm11g7f	Possible Ordnance
97	065-4-dp32g60f	Possible Ordnance
98	065-5-dp127g20f	Possible Ordnance
99	065-6-nm363g52f	Pipeline
100	065-7-pm176g186f	Geological Feature
101	065-8-pm24g38f	Possible Ordnance
102	065-9-pm44g37f	Possible Ordnance
103	065-10-mc69g110f	Geological Feature
104	064-1-pm108g121f	Geological Feature
105	064-2-mc67g61f	Possible Ordnance
106	064-3-pm27g21f	Possible Ordnance
107	064-4-pm193g210f	Geological Feature
108	064-5-nm363g63f	Pipeline

TABLE 2

MAGNETIC ANOMALY LOCATION AND INTERPRETATION

**Congaree River Sediments
Columbia, South Carolina**

Designation	Characteristics	Potential Interpretation
109	064-6-pm63g16f	Possible Ordnance
110	064-7-dp415g60f	Possible Ordnance
111	063-1-dp395g68f	Possible Ordnance
112	063-2-pm67g14f	Possible Ordnance
113	063-3-nm188g73f	Possible Ordnance
114	063-4-nm334g26f	Pipeline
115	063-5-pm224g187f	Geological Feature
116	063-6-pm111g143f	Geological Feature
117	062-1-pm99g136f	Geological Feature
118	062-2-pm203g163f	Geological Feature
119	062-3-nm257g48f	Pipeline
120	062-4-dp373g110f	Possible Ordnance
121	062-5-mc68g107f	Possible Ordnance
122	062-6-pm59g55f	Possible Ordnance
123	061-1-pm127g57f	Possible Ordnance
124	061-2-pm182g43f	Possible Ordnance
125	061-3-pm113g52f	Possible Ordnance
126	061-4-nm198g67f	Pipeline
127	061-5-pm225g210f	Geological Feature
128	061-6-pm112g147f	Geological Feature
129	060-1-pm109g18f	Geological Feature
130	060-2-pm66g46f	Possible Ordnance
131	060-3-pm246g205f	Geological Feature
132	060-4-nm107g38f	Pipeline
133	060-5-dp288g93f	Possible Ordnance
134	059-1-nm124g99f	Possible Ordnance
135	059-2-dp73g64f	Possible Ordnance
136	059-3-pm240g200f	Geological Feature
137	059-4-dp76g55f	Possible Ordnance
138	059-5-dp140g102f	Possible Ordnance
139	059-6-dp241g37f	Geological Feature
140	058-1-dp114g101f	Geological Feature
141	058-2-nm65g51f	Possible Ordnance
142	058-3-pm87g33f	Possible Ordnance
143	058-4-mc248g200f	Geological Feature
144	058-5-nm44g15f	Possible Ordnance
145	058-6-dp137g91f	Possible Ordnance
146	057-1-pm144g94f	Pipeline
147	057-2-pm67g62f	Possible Ordnance
148	057-3-dp54g14f	Possible Ordnance
149	057-4-mc231g180f	Geological Feature
150	057-5-pm55g57f	Possible Ordnance
151	057-6-nm30g36f	Possible Ordnance
152	057-7-dp138g78f	Possible Ordnance
153	057-8-dp135g41f	Geological Feature
154	056-1-pm144g157f	Geological Feature
155	056-2-nm36g22f	Possible Ordnance
156	056-3-pm129g33f	Possible Ordnance
157	056-4-dp34g15f	Possible Ordnance
158	056-5-dp83g70f	Possible Ordnance
159	056-6-mc210g153f	Geological Feature
160	056-7-dp53g21f	Possible Ordnance
161	056-8-dp103g46f	Possible Ordnance
162	056-9-mc178g110f	Pipeline

TABLE 2

MAGNETIC ANOMALY LOCATION AND INTERPRETATION

**Congaree River Sediments
Columbia, South Carolina**

Designation	Characteristics	Potential Interpretation
163	055-1-pm277g110f	Pipeline
164	055-2-nm75g32f	Possible Ordnance
165	055-3-dp54g15f	Possible Ordnance
166	055-4-pm127g62f	Possible Ordnance
167	055-5-pm195g58f	Geological Feature
168	055-6-dp221g64f	Possible Ordnance
169	055-7-dp28g10f	Possible Ordnance
170	055-8-pm146g36f	Possible Ordnance
171	055-9-dp18g20f	Possible Ordnance
172	055-10-pm138g123f	Geological Feature
173	054-1-dp65g44f	Possible Ordnance
174	054-2-dp66g30f	Possible Ordnance
175	054-3-dp62g38f	Possible Ordnance
176	054-4-pm196g90f	Geological Feature
177	054-5-dp100g48f	Possible Ordnance
178	054-6-dp106g20f	Possible Ordnance
179	054-7-dp47g15f	Possible Ordnance
180	054-8-pm479g50f	Pipeline
181	053-1-nm71g18f	Possible Ordnance
182	053-2-nm21g26f	Possible Ordnance
183	053-3-mn90g46f	Possible Ordnance
184	053-4-dp26g17f	Possible Ordnance
185	053-5-nm32g15f	Possible Ordnance
186	053-6-pm71g56f	Possible Ordnance
187	053-7-pm199g57f	Geological Feature
188	053-8-nm111g38f	Iron Pipe
189	053-9-nm51g20f	Possible Ordnance
190	0543-10-dp43g40f	Possible Ordnance
191	053-11-nm70g66f	Possible Ordnance
192	053-12-pm115g105f	Geological Feature
193	052-1-pm129g142f	Geological Feature
194	052-2-dp99g63f	Possible Ordnance
195	052-3-mc292g160f	Iron Pipe
196	052-4-dp60g42f	Possible Ordnance
197	052-5-pm63g30f	Possible Ordnance
198	052-6-dp47g12f	Possible Ordnance
199	052-7-dp251g53f	Possible Ordnance
200	051-1-mc601g117f	Iron Pipe
201	051-2-nm97g26f	Possible Ordnance
202	050-1-nm94g33f	Possible Ordnance
203	050-2-dp102g45f	Possible Ordnance
204	050-3-pm50g17f	Possible Ordnance
205	050-4-pm818g20fEOL	Possible Ordnance
206	049-1-pm112g64f	Possible Ordnance
207	049-2-pm111g78f	Possible Ordnance
208	049-3-dp74g66f	Possible Ordnance
209	049-4-dp75g70f	Possible Ordnance
210	048-1-nm74g38f	Possible Ordnance
211	048-2-dp13g14f	Possible Ordnance
212	049-3-nm104g28f	Possible Ordnance
213	048-4-pm127g53f	Possible Ordnance
214	048-5-pm22g28f	Possible Ordnance
215	047-1-nm119g46fEOL	Possible Ordnance
216	047-2-dp13g15f	Possible Ordnance

TABLE 2

MAGNETIC ANOMALY LOCATION AND INTERPRETATION

Congaree River Sediments
Columbia, South Carolina

Designation	Characteristics	Potential Interpretation
217	047-3-nm89g33f	Possible Ordnance
218	046-1-nm223g37f	Possible Ordnance
219	078-1-pm1949g7f	Possible Ordnance
220	068-1-dp311g7f	Possible Ordnance
221	045-1-mc6548g8f	Electromagnetic Anomaly
222	062L-1-pm150g5f	Possible Ordnance
223	062L-2-nm109g11f	Possible Ordnance
224	061L-1-nm135g4f	Possible Ordnance
225	061L-2-pm95g6f	Possible Ordnance
226	061L-3-dp105g20f	Possible Ordnance
227	060L-1-pm113g3f	Possible Ordnance
228	060L-2dp93g27f	Possible Ordnance
229	059L-1-nm150g25f	Possible Ordnance
230	058L-1-pm302g11f	Possible Ordnance
231	058L-2-pm79g16f	Possible Ordnance
232	057L-1-dp257g7f	Possible Ordnance
233	056L-dp150g11f	Possible Ordnance
234	056L-2-pm43g10f	Possible Ordnance
235	055L-1-dp201g11f	Possible Ordnance
236	054L-1-nm166g9f	Possible Ordnance
237	001SL-1-pm4902g20	Boiler
238	001SL-2-pm4554g4f	Possible Ordnance
239	001SL-3-mc8907g11f	Electromagnetic Anomaly
240	002SL-1-dp8978g9f	Possible Ordnance
241	002SL-2-dp3987g7f	Possible Ordnance
242	002SL-3-mc7345g7f	Possible Ordnance
243	003SL-1-pm269g10f	Possible Ordnance
244	003SL-2-pm515g7f	Possible Ordnance
245	003SL-3-nm80g5f	Possible Ordnance
246	003SL-4-dp168g19f	Boiler
247	003SL-5-pm129g6f	Washing Machine
248	060L-1-nm105g20f	Possible Ordnance
249	059L-1-nm279g5f	Possible Ordnance
250	059L-2-pm423g34f	Possible Ordnance
251	058L-1-dp209g6f	Possible Ordnance
252	058L-2-pm35g11f	Possible Ordnance
253	057L-1-nm17g11f	Possible Ordnance
254	057L-2-pm98g8f	Possible Ordnance
255	057L-3-pm37g9f	Possible Ordnance
256	057L-4-pm38g11f	Possible Ordnance
257	057L-5-dp75g10f	Sign
258	056L-1-mc8186g11f	Possible Ordnance
259	055L-1-mc5360g20f	Possible Ordnance
260	055L-2-nm357g19f	Possible Ordnance
261	054L-1-261g11f	Possible Ordnance
262	054L-2-pm312g8f	Possible Ordnance
263	053L-1-nm110g9f	Possible Ordnance
264	053L2-dp109g16f	Possible Ordnance
265	052L-1-dp286g3f	Manhole
266	052L-2-pm327g9f	Possible Ordnance
267	052L-3-nm248g21f	Possible Ordnance
268	052L-4-dp259g26f	Possible Ordnance
269	051L-1-nm109g13f	Possible Ordnance
270	067-1-dp48g33f	Possible Ordnance

TABLE 2

MAGNETIC ANOMALY LOCATION AND INTERPRETATION

**Congaree River Sediments
Columbia, South Carolina**

Designation	Characteristics	Potential Interpretation
271	067-2-dp142g44f	Possible Ordnance
272	0701-dp480g13f	Possible Ordnance
273	070-2-pm49g11f	Possible Ordnance
274	072-1-pm89g13f	Possible Ordnance
275	073-1-nm80g5f	Possible Ordnance
276	073-2-nm356g23f	Possible Ordnance
277	075-1-nm364g11f	Possible Ordnance
278	075-2-dp1039g39f	Possible Ordnance
279	077-1-dp123g14f	Possible Ordnance
280	077-2-dp776g30f	Possible Ordnance
281	078R-3mc8302g20f	Electromagnetic Anomaly
282	068-1-dp320g7f	Possible Ordnance
283	068R-2-mc9213g15f	Electromagnetic Anomaly
284	066R-1-mc8334g15f	Electromagnetic Anomaly
285	065R-1-mc8486g18f	Electromagnetic Anomaly
286	064R-1-mc9633g18f	Electromagnetic Anomaly
287	063R-1-mc9404g19f	Electromagnetic Anomaly
288	062R-2-mc9746g18f	Electromagnetic Anomaly
289	061R-1-mc7773g16f	Electromagnetic Anomaly
290	060R-1-mc8127g8f	Electromagnetic Anomaly
291	059R-1-mc5961g11f	Electromagnetic Anomaly
292	058R-1-mc6758g17f	Electromagnetic Anomaly
293	057R-1-mc7119g24f	Electromagnetic Anomaly
294	056R-1-mc7891g16f	Electromagnetic Anomaly
295	055R-1-mc6461g17f	Electromagnetic Anomaly
296	054R-1-mc9645g16f	Electromagnetic Anomaly
297	053R-1-mc6680g13f	Electromagnetic Anomaly
298	052R-1-mc9795g10f	Electromagnetic Anomaly
299	051R-1-mc6531g15f	Electromagnetic Anomaly
300	050R-1-mc6531g14f	Electromagnetic Anomaly
301	049R-1-mc9574g7f	Electromagnetic Anomaly
302	048R-1-mc6550g12f	Electromagnetic Anomaly
303	047BR-1-mc6477g7f	Electromagnetic Anomaly
304	045R-1-mc6548g8f	Electromagnetic Anomaly
305	003-4-dp103g12f	Possible Ordnance
306	004-1-pm93g10f	Possible Ordnance
307	003-3-pm58g16f	Possible Ordnance
308	002-1-dp38g9f	Possible Ordnance
309	003-2-pm96g11f	Possible Ordnance
310	004-3-pm95g12f	Possible Ordnance
311	001-1-pm54g6f	Possible Ordnance
312	006-2-nm207g12f	Possible Ordnance
313	004-2-pm81g9f	Possible Ordnance
314	003-1-pm19g4f	Possible Ordnance
315	004-4-pm78g8f	Possible Ordnance
316	006-1-dp191g16f	Possible Ordnance
317	002-2-dp53g11f	Possible Ordnance
318	004-5-pm85g11f	Possible Ordnance
319	004-6-pm71g10f	Possible Ordnance
320	004-7-pm82g12f	Possible Ordnance
321	004-8-dp156g19f	Possible Ordnance
322	002-3-nm32g8f	Possible Ordnance
323	053L-4-dp437g70f	Iron Pipe
324	022-1-pm100g25f	Possible Ordnance

TABLE 2

MAGNETIC ANOMALY LOCATION AND INTERPRETATION

Congaree River Sediments
Columbia, South Carolina

Designation	Characteristics	Potential Interpretation
325	021-2-nm400g25f	Possible Ordnance
326	021-2-pm70g20f	Possible Ordnance
327	012-1-pm270g23f	Possible Ordnance
328	011-1-dp225g75f	Possible Ordnance
329	010-1-nm50g15f	Possible Ordnance
330	020-1-dp22g15f	Possible Ordnance
331	016-1-pm38g37f	Possible Ordnance
332	020-2-dp23g13f	Possible Ordnance
333	020-3-dp18g16f	Possible Ordnance
334	A	Possible Ordnance
335	B	Possible Ordnance
336	C	Possible Ordnance
337	D	Possible Ordnance
338	E	Possible Ordnance
339	F	Possible Ordnance
340	G	Possible Ordnance
341	H	Possible Ordnance
342	1-1-mc806g44f	Possible Ordnance
343	1-2-pm100g9f	Possible Ordnance
344	1-3-dp533g47f	Possible Ordnance
345	1-4-dp233g24f	Possible Ordnance
346	1-5-pm73g13f	Possible Ordnance
347	1-6-dp210g33f	Possible Ordnance
348	22-1-dp544g65f	Pipeline
349	21-1-pm323g42f	Possible Ordnance
350	21-2-dp1330g64f	Pipeline
351	20-1-dp94g25f	Possible Ordnance
352	20-2-dp2601g102f	Pipeline
353	19-1-pm79g8f	Possible Ordnance
354	19-2-pm113g18f	Possible Ordnance
355	19-3-dp154g31f	Possible Ordnance
356	19-3-dp1419g86f	Pipeline
357	18-1-dp333g16f	Possible Ordnance
358	18-2-dp40g17f	Possible Ordnance
359	18-3-dp105g24f	Possible Ordnance
360	18-4-dp196g34f	Possible Ordnance
361	18-5-pm13g8f	Possible Ordnance
362	18-6-dp2092g60f	Pipeline
363	18-6-dp83g22f	Possible Ordnance
364	18-7-dp?1687+g18+f	Pipeline
365	17-1-dp1497g47f	Pipeline
366	17-2-dp47g44f	Possible Ordnance
367	17-3-pm29g16f	Possible Ordnance
368	17-4-mc53g35f	Possible Ordnance
369	16-1-nm61g10f	Possible Ordnance
370	16-2-dp136g17f	Possible Ordnance
371	16-3-pm50g27f	Possible Ordnance
372	16-5-dp10g6f	Possible Ordnance
373	16-6-pm47g26f	Possible Ordnance
374	15-1-dp59g30f	Possible Ordnance
375	15-2-pm43g16f	Possible Ordnance
376	15-3-dp304g29f	Possible Ordnance
377	14-1-dp136g21f	Possible Ordnance
378	14-2-dp185g32f	Possible Ordnance

TABLE 2

MAGNETIC ANOMALY LOCATION AND INTERPRETATION

Congaree River Sediments
Columbia, South Carolina

Designation	Characteristics	Potential Interpretation
379	14-4-pm95g31f	Possible Ordnance
380	10-1-nm29g25f	Possible Ordnance
381	10-2-dp31g260f	Possible Ordnance
382	10-2-nm57g13f	Possible Ordnance
383	13-1-dp66g23f	Possible Ordnance
384	13-2-pm40g21f	Possible Ordnance
385	13-3-pm27g17f	Possible Ordnance
386	13-4-dp46g10f	Possible Ordnance
387	12-1-dp40g30f	Possible Ordnance
388	12-2-pm46g33f	Possible Ordnance
389	11-1-pm22g39f	Possible Ordnance
390	11-2-pm39g31f	Possible Ordnance
391	10-1-dp95g21f	Possible Ordnance
392	9-1-dp78g23f	Possible Ordnance
393	8-1-dp247g13f	Possible Ordnance
394	7-1-dp180g23f	Possible Ordnance
395	7-2-dp145g20f	Possible Ordnance
396	6-1-dp138g15f	Possible Ordnance
397	6-2-dp235g26f	Possible Ordnance
398	5-1-pm103g31f	Possible Ordnance
399	5-2-dp53g57f	Possible Ordnance
400	4-1-pm103g15f	Possible Ordnance
401	4-2-dp49g12f	Possible Ordnance
402	2-1-pm110g13f	Possible Ordnance
403	15-1-mc16g4f	Possible Ordnance
404	14-1-dp68g16f	Possible Ordnance
405	13-1-dp53g7f	Possible Ordnance
406	13-2-dp188g28f	Possible Ordnance
407	12-1-pm11g29f	Possible Ordnance
408	11-1-dp528g20f	Possible Ordnance
409	9-1-dp342g22f	Possible Ordnance
410	8-1-dp135g24f	Possible Ordnance
411	8-2-dp72g23f	Possible Ordnance
412	8-1-dp34g16f	Possible Ordnance
413	6-1-pm32g5f	Possible Ordnance
414	5-1-dp47g21f	Possible Ordnance
415	4-1-dp218g25f	Possible Ordnance
416	4-2-dp80g21f	Possible Ordnance
417	3-1-dp146g27f	Possible Ordnance
418	3-2-pm123g17f	Possible Ordnance
419	3-3-dp85g22f	Possible Ordnance
420	1-1-dp112g18f	Possible Ordnance
421	22-1-dp122g37f	Possible Ordnance
422	22-3-nm28g10f	Possible Ordnance
423	22-2-pm17g10f	Possible Ordnance
424	1-1-pm73g12f	Possible Ordnance
425	1-2-pm215g23f	Possible Ordnance
426	2-1-dp185g16f	Possible Ordnance
427	2-2-mc287g46f	Possible Ordnance
428	2-3-dp107g24f	Possible Ordnance
429	1-1-dp55g16f	Possible Ordnance
430	1-2-dp223g45f	Possible Ordnance
431	1-3-dp700g35f	Possible Ordnance
432	1-4-dp97g25f	Possible Ordnance

TABLE 2

MAGNETIC ANOMALY LOCATION AND INTERPRETATION

Congaree River Sediments
Columbia, South Carolina

Designation	Characteristics	Potential Interpretation
433	5-1-dp89g22f	Possible Ordnance
434	13-1-dp44g15f	Possible Ordnance
435	13-2-dp37g24f	Possible Ordnance
436	14-1-dp28g14f	Possible Ordnance
437	11-1-dp52g44f	Possible Ordnance
438	11-2-dp72g43f	Possible Ordnance
439	10-1-pm41g18f	Possible Ordnance
440	10-2-pm20g11f	Possible Ordnance
441	10-3-dp72g35f	Possible Ordnance
442	10-4-pm74g23f	Possible Ordnance
443	9-1-dp281g31f	Possible Ordnance
444	7-1-dp208g20f	Possible Ordnance
445	7-2-dp125g23f	Possible Ordnance
446	7-3-pm115g10f	Possible Ordnance
447	6-1-dp152g34f	Possible Ordnance
448	6-2-mc175g49f	Possible Ordnance
449	5-1-pm60g11f	Possible Ordnance
450	5-2-pm32g6f	Possible Ordnance
451	5-3-pm63g12f	Possible Ordnance
452	5-4-pm50g7f	Possible Ordnance
453	5-5-dp65g4f	Possible Ordnance
454	5-6-mc6558g70f	Possible Ordnance
455	4-1-dp164g41f	Possible Ordnance
456	4-2-pm177g20f	Possible Ordnance
457	4-3-nm220g17f	Possible Ordnance
458	11-1-dp208g48f	Possible Ordnance
459	11-2-dp28g17f	Possible Ordnance
460	14-1-pm293g50f	Possible Ordnance
461	14-1-pm153g18f	Possible Ordnance
462	15-1-pm136g14f	Possible Ordnance
463	001-1-mc30093g25f	Possible Ordnance
464	022-1-mc31539g13f	Possible Ordnance
465	021-1-mc28767g12f	Possible Ordnance
466	020-1-mc31683g35f	Possible Ordnance
467	018-1-mc31942g23f	Possible Ordnance
468	018-1-mc31657g24f	Possible Ordnance
469	017-1-mc26003g23f	Possible Ordnance
470	017-1-dp67g14f	Possible Ordnance
471	014-1-mc26324g17f	Electromagnetic Anomaly
472	013-1-mc31252g8f	Electromagnetic Anomaly
473	013-2-mc16747g7f	Electromagnetic Anomaly
474	012-1-mc27653g21f	Electromagnetic Anomaly
475	011-1-mc34257g22f	Electromagnetic Anomaly
476	010-1-mc26761g24f	Electromagnetic Anomaly
477	009-1-mc29279g28f	Electromagnetic Anomaly
478	008-1-mc30182g22f	Electromagnetic Anomaly
479	07-1-mc21762g7f	Electromagnetic Anomaly
480	006-1-mc27687g21f	Electromagnetic Anomaly
481	005-1-mc30284g22f	Electromagnetic Anomaly
482	004-1-mc26874g21f	Electromagnetic Anomaly
483	003-1-mc28428g18f	Electromagnetic Anomaly
484	002-1-mc30321g12f	Electromagnetic Anomaly
485	007-1-pm6g10f	Tire
486	010-1-pm38g15f	Lamp

TABLE 2

MAGNETIC ANOMALY LOCATION AND INTERPRETATION

**Congaree River Sediments
Columbia, South Carolina**

Designation	Characteristics	Potential Interpretation
487	01-1-nm77g7f	Possible Ordnance
488	01-2-mc187g13f	Pipeline Associated
489	02-1-dp662gEOL	Pipeline Associated
490	03-1-mc795g52f	Pipeline Associated
491	03-2-nm47g6f	Pipeline Associated
492	03-3-nm321g45f	Possible Ordnance
493	03-4-pm190g2f	Possible Ordnance
494	03-5-dp2178gEOL	Possible Ordnance
495	03-6-dp156g18f	Possible Ordnance
496	04-1-dp2770g35f	Pipeline Associated
497	04-2-dp44891g35f	Electromagnetic Anomaly
498	04-3-mc44891g7f	Electromagnetic Anomaly
499	05-1-pm2582g30f	Possible Ordnance
500	05-2-pm705g21f	Pipeline Associated
501	05-3-pm139g13f	Possible Ordnance
502	05-4-nm169g17f	Possible Ordnance
503	06-1-pm1537g21f	Possible Ordnance
504	06-2-dp216g15f	Possible Ordnance
505	06-3-dp2658g33f	Pipeline Associated
506	06-4-pm96g13f	Possible Ordnance
507	06-5-pm90g10f	Possible Ordnance
508	06-6-dp109g12f	Possible Ordnance
509	06-7-pm36g4f	Possible Ordnance
510	07-1-dp1681g38f	Possible Ordnance
511	07-2-pm70g6f	Possible Ordnance
512	07-3-mc3436g43f	Pipeline Associated
513	07-4-dp608g39f	Possible Ordnance
514	08-1-nm61g14f	Possible Ordnance
515	08-2-mc138g24f	Possible Ordnance
516	08-3-dp2380g51f	Pipeline Associated
517	08-4-pm1479g40f	Possible Ordnance
518	08-5-nm20g2f	Possible Ordnance
519	08-6-mc244gEOL	Possible Ordnance
520	09-1-nm157g9f	Possible Ordnance
521	09-2-pm2592g48f	Possible Ordnance
522	09-3-dp129g6f	Possible Ordnance
523	09-4-dp4790g50f	Pipeline Associated
524	09-5-pm23864g4f	Electromagnetic Anomaly
525	09-6-pm34g13f	Possible Ordnance
526	10-1-pm37g24f	Possible Ordnance
527	10-2-dp6063g73f	Pipeline Associated
528	10-3-mc34109g1f	Electromagnetic Anomaly
529	10-4-pm2385g43f	Possible Ordnance
530	10-5-mc92g2f	Possible Ordnance
531	11-1-pm1474g41f	Possible Ordnance
532	11-2-dp2385g29f	Pipeline Associated
533	11-3-mc207g22f	Possible Ordnance
534	11-4-dp52g19f	Possible Ordnance
535	12-1-pm52g7f	Possible Ordnance
536	12-2-nm398g18f	Possible Ordnance
537	12-3-pm75g7f	Possible Ordnance
538	12-4-nm29g4f	Possible Ordnance
539	12-5-nm24g3f	Possible Ordnance
540	12-6-nm115g3f	Possible Ordnance

TABLE 2

MAGNETIC ANOMALY LOCATION AND INTERPRETATION

**Congaree River Sediments
Columbia, South Carolina**

Designation	Characteristics	Potential Interpretation
541	12-7-nm23g8f	Possible Ordnance
542	12-8-mc457g25f	Possible Ordnance
543	12-9-mc613g30f	Possible Ordnance
544	12-10-nm642g43f	Possible Ordnance
545	13-1-dp244g28f	Possible Ordnance
546	13-2-nm213g24f	Possible Ordnance
547	13-3-nm224g18f	Possible Ordnance
548	13-4-nm156g14f	Possible Ordnance
549	13-5-dp25g9f	Possible Ordnance
550	14-1-nm61g15f	Possible Ordnance
551	14-2-nm234g18f	Possible Ordnance
552	14-3-dp193g23f	Possible Ordnance
553	14-4-dp462g36f	Possible Ordnance
554	14-5-nm19g6f	Possible Ordnance
555	14-6-dp646g26f	Possible Ordnance
556	14-7-dp1357g24f	Possible Ordnance
557	16-1-dp400g18f	Possible Ordnance
558	16-2-pm160g17f	Possible Ordnance
559	16-3-dp368g20f	Possible Ordnance
560	16-4-mc403g30f	Possible Ordnance
561	16-5-pm36g11f	Possible Ordnance
562	16-6-pm12g4f	Possible Ordnance
563	16-7-pm35g13f	Possible Ordnance
564	17-1-dp273g42f	Possible Ordnance
565	18-1-dp527g12f	Possible Ordnance
566	18-2-pm91g8f	Possible Ordnance
567	19-1-dp528g38f	Possible Ordnance
568	19-2-pm166g7f	Possible Ordnance
569	19-3-dp1000g33f	Possible Ordnance
570	20-1-mc48849g8f	Electromagnetic Anomaly

TABLE 3

ANOMALIES BY PLANNED PROJECT AREA

Congaree River Sediments
Columbia, South Carolina

Construction Phase	Potential Ordnance (UXO)	Potential UXO Under the Footprint of the Cofferdam	Other Anomalies	Total Magnetic Anomalies
Field Demonstration Project Area	84	0	17	101
Phase I	84	20	14	118
Phase II	45	9	16	70
Phase III	2	14	17	33
Outside of Project Area	210	0	38	248
Total Anomalies	425	43	102	570

Notes:

Please refer to Figures 2 and 3.

1. All magnetometer work was completed by Tidewater Atlantic Research, Inc of Washington, North Carolina.
2. Magnetic Anomalies - As determined by Tidewater by the magnetic, remote-sensing survey.
3. UXO - Unexploded Ordnance
4. UXO Potential - Referring to Magnetic Anomalies that "have signature characteristics that could be associated with ordnance" and "those anomalies should be considered potentially hazardous until material generating the signatures can be identified".
5. Other - Other magnetic anomalies include pipelines, geologic features, modern debris etc.

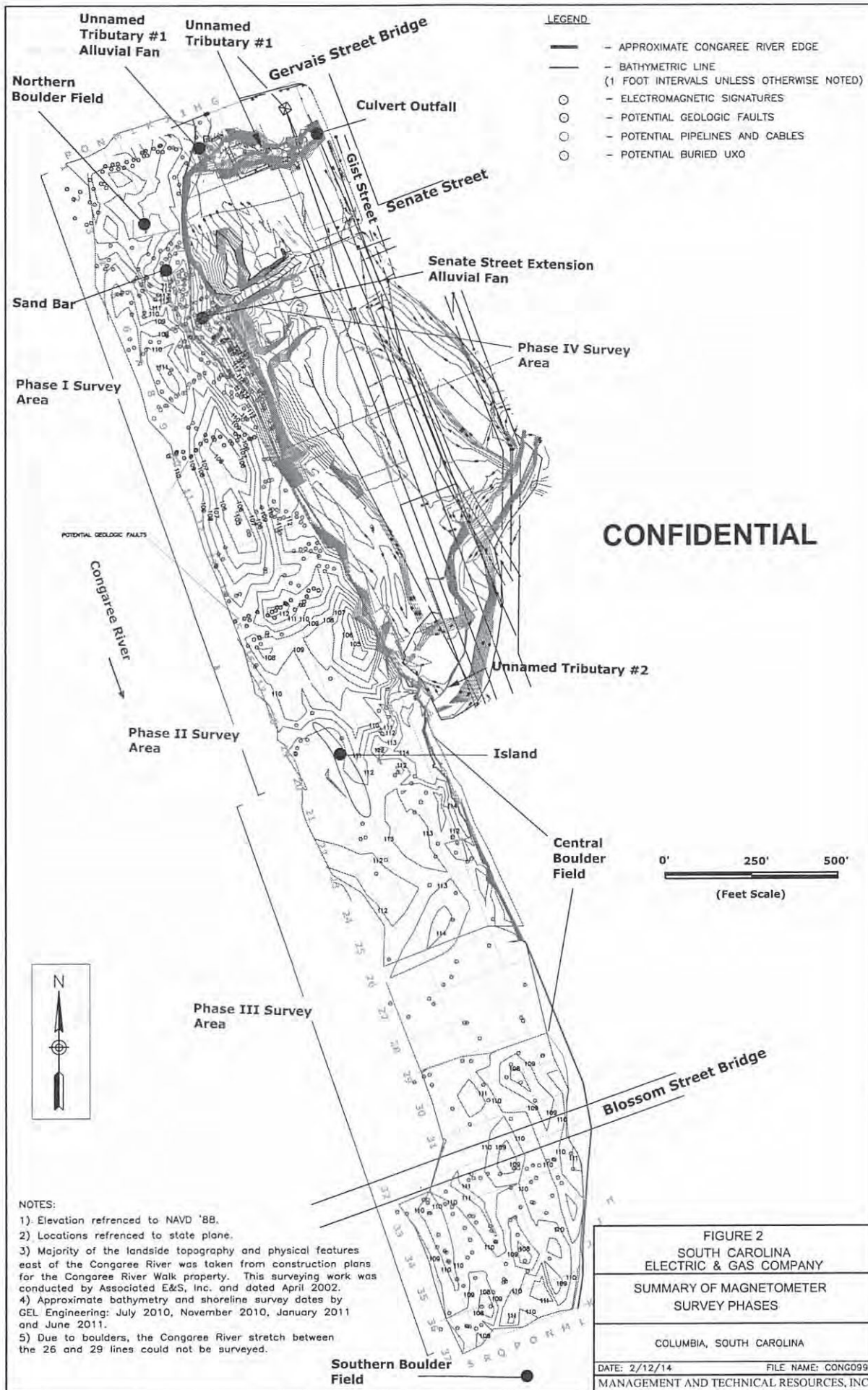

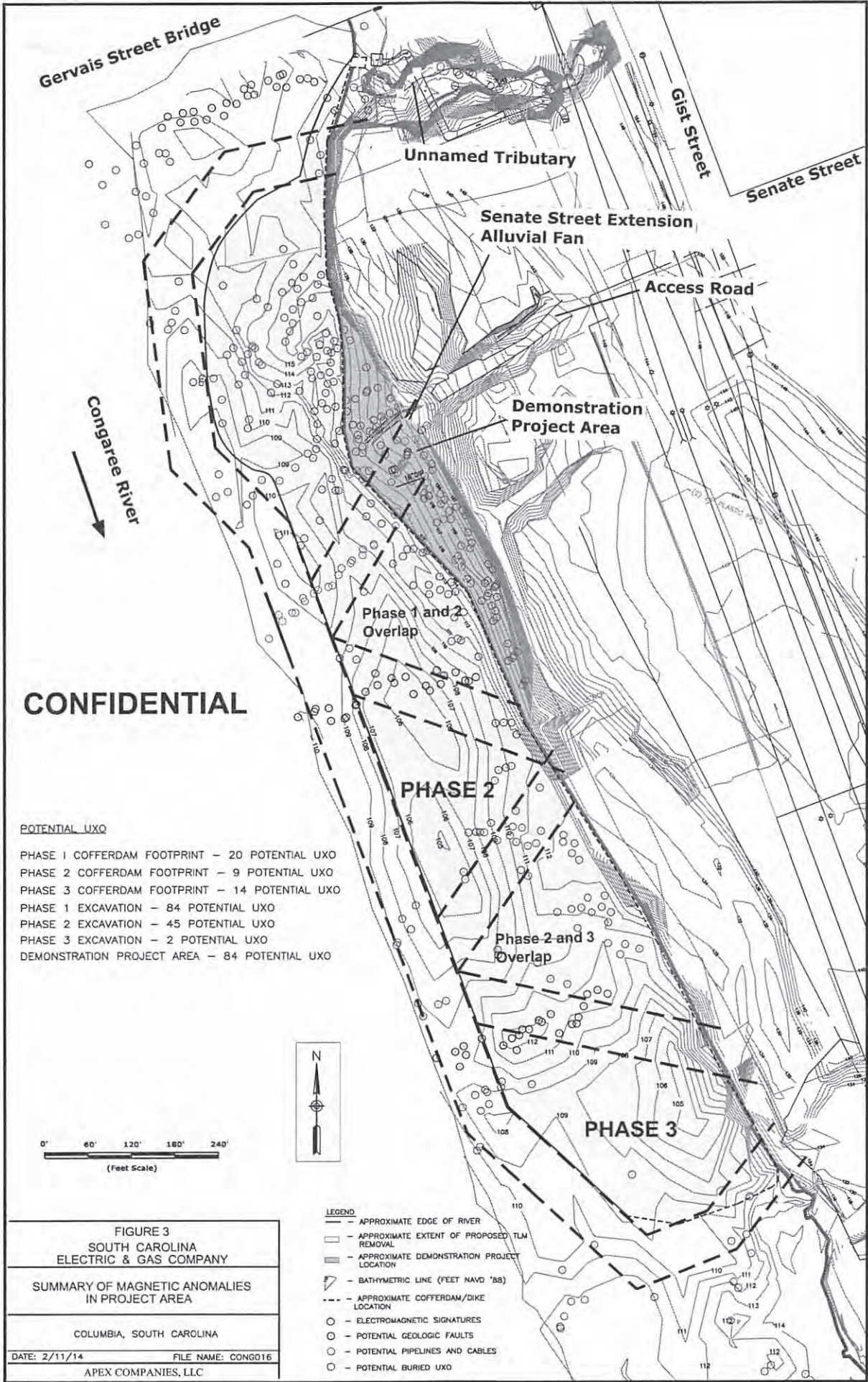

CONFIDENTIAL

POTENTIAL UXO

PHASE 1 COFFERDAM FOOTPRINT - 20 POTENTIAL UXO
 PHASE 2 COFFERDAM FOOTPRINT - 9 POTENTIAL UXO
 PHASE 3 COFFERDAM FOOTPRINT - 14 POTENTIAL UXO
 PHASE 1 EXCAVATION - 84 POTENTIAL UXO
 PHASE 2 EXCAVATION - 45 POTENTIAL UXO
 PHASE 3 EXCAVATION - 2 POTENTIAL UXO
 DEMONSTRATION PROJECT AREA - 84 POTENTIAL UXO

FIGURE 3
 SOUTH CAROLINA
 ELECTRIC & GAS COMPANY

SUMMARY OF MAGNETIC ANOMALIES
 IN PROJECT AREA

COLUMBIA, SOUTH CAROLINA

DATE: 2/11/14 FILE NAME: CONG016

APEX COMPANIES, LLC

- LEGEND**
- - - APPROXIMATE EDGE OF RIVER
 - APPROXIMATE EXTENT OF PROPOSED TLM REMOVAL
 - APPROXIMATE DEMONSTRATION PROJECT LOCATION
 - - - BATHYMETRIC LINE (FEET NAVD '88)
 - - - APPROXIMATE COFFERDAM/DIKE LOCATION
 - ELECTROMAGNETIC SIGNATURES
 - POTENTIAL GEOLOGIC FAULTS
 - POTENTIAL PIPELINES AND CABLES
 - POTENTIAL BURIED UXO



**ARCHAEOLOGICAL DATA RECOVERY PLAN FOR THE
MITIGATION OF SITE 38RD286/38RD278, THE ORDNANCE
DUMP SITE, FOR THE CONGAREE RIVER SEDIMENT
REMOVAL PROJECT, COLUMBIA, SOUTH CAROLINA**

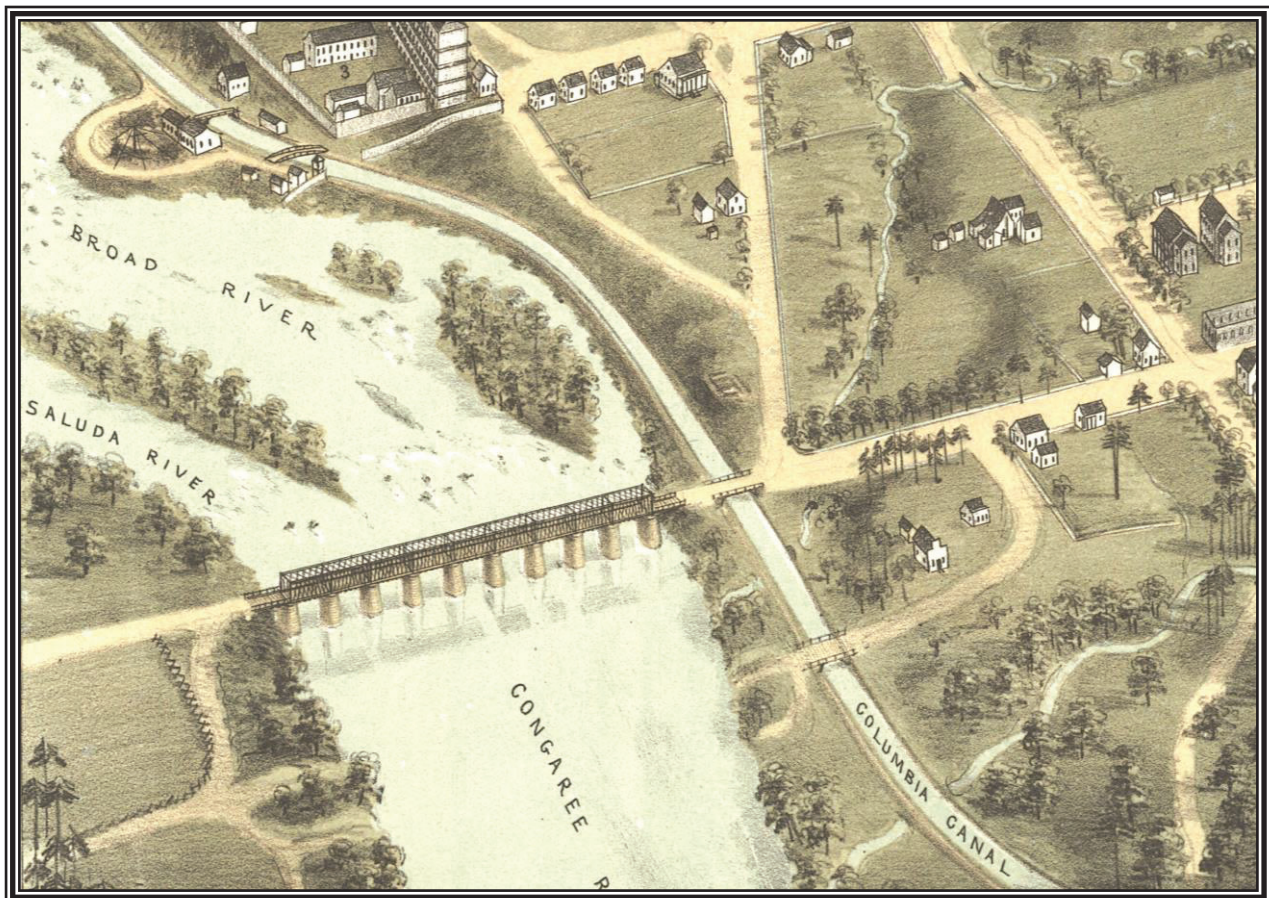

Birdseye View of the city of Columbia showing the Gervais Street Bridge (C. Drie, 1872).

September 2020

**ARCHAEOLOGICAL DATA RECOVERY PLAN FOR THE
MITIGATION OF SITE 38RD286/38RD278, THE ORDNANCE
DUMP SITE, FOR THE CONGAREE RIVER SEDIMENT
REMOVAL PROJECT, COLUMBIA, SOUTH CAROLINA**

Submitted to:

DOMINION ENERGY SOUTH CAROLINA, INC.
200 Operation Way
Cayce, South Carolina 29033

By:

TRC ENVIRONMENTAL CORPORATION
621 Chatham Avenue
Columbia, South Carolina 29205



Sean Norris, Program Manager Archaeology

September 2020

INTRODUCTION

TRC Environmental Corporation (TRC) is pleased to provide the following information for Artifact Recovery and Artifact Conservation for Site 38RD286/38RD278 as related to the Congaree River Sediment Removal Project. This plan is being submitted as one the stipulations agreed upon in a Memorandum of Agreement between the U.S. Army Corps of Engineers, the State Historic Preservation Officer (SHPO) and Dominion Energy South Carolina, Inc. (Dominion). It also serves as the application for an Exclusive Commercial Data Recovery Salvage License as pursuant to the Underwater Antiquities Act of 1991 (Article 5, Chapter 7, Title 54, Code of Laws of South Carolina, 1976). Due to the extensive nature of the undertaking a one-year license is being requested with the expectation that up to three additional year-long extensions will be requested.

The excavation and recovery of submerged artifacts will be conducted in support of and concurrently with a large-scale environmental remediation project. The project involves the remediation of contaminated sediments in the Congaree River. In June 2010, tarlike material (TLM) was reported near the eastern shoreline of the Congaree River directly downstream of the Gervais Street Bridge. The South Carolina Department of Health and Environmental Control (SCDHEC) began sampling material from the river and concluded that the source of the TLM was a manufactured gas plant (MGP) that operated on Huger Street in downtown Columbia from 1906 to the mid-1950s. During its period of operation, the MGP had allowed coal tar runoff to empty into the Congaree River.

This MGP, after a series of mergers and acquisitions, became one of South Carolina Electric and Gas's (SCE&G now Dominion) predecessor companies. As a result, SCE&G/Dominion owned the land the former MGP occupied. In 2002 SCE&G/Dominion had entered into a Voluntary Cleanup Contract with SCDHEC to mitigate the former MGP site. Beginning in 2008 SCE&G/Dominion removed over 125,000 tons of MGP impacted soil and debris from the Huger Street location. Since the discovery of tar in the river SCE&G/Dominion has worked with SCDHEC in order to define the extent of the TLM contamination and has conducted a series of surveys to establish the vertical and horizontal distribution of the TLM. The project area begins directly south of the Gervais Street Bridge and extends downstream for approximately 2,000 feet; it extends approximately 300 feet into the river from the eastern bank (Figure 1).

In 2013 SCDHEC approved the Project Delineation Report and tasked SCE&G/Dominion to develop an appropriate plan for the removal and mitigation of the contaminated soil. In 2013 a report detailing four "removal action" options was submitted to SCDHEC. The four options were:

1. No Action – Leave the TLM in place.
2. Monitoring and Institutional Controls – Leave the TLM in place, restrict access to the area, and conduct annual monitoring.
3. Sediment Capping and Institutional Controls – Place a physical barrier on top of the contaminated sediment effectively burying the TLM and conduct annual monitoring.
4. Removal – Physically remove the TLM and contaminated sediment.

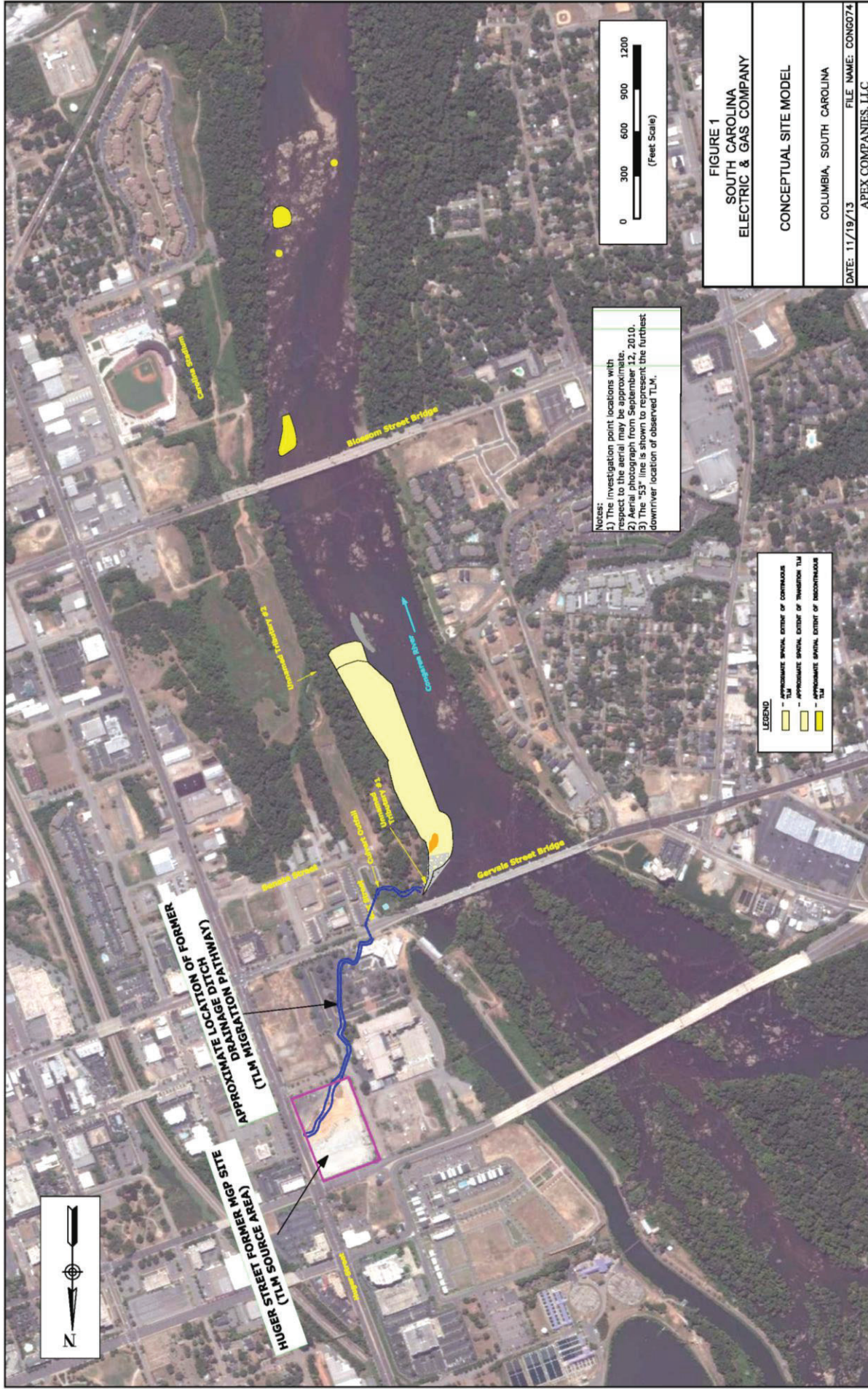

Figure 1. Project location map.

SCDHEC approved option four as the preferred method of dealing with the TLM. This method was deemed to be the most protective of human health and the environment because it would permanently remove the contaminated sediment.

PROJECT DESCRIPTION

The project will mitigate adverse effects to the portions of Site 38RD286/38RD278 affected by the undertaking through a combination of preservation in place and data recovery (Figure 2). The portions of the site outside the impact area will be left in place and naturally protected by the river and sediment.

The sediment that is removed will be subject to data recovery. The recovery of archaeologically significant artifacts will take place concurrently with the proposed environmental remediation project. The remediation of the TLM and contaminated sediments will involve the following activities:

- Conducting landside clearing, grading and site setup activities;
- Physically removing sediment and debris using conventional equipment;
- Conditioning the removed sediment material, as needed, for transportation to the landfill; and
- Off-site disposal.

Prior to activities in the river, construction on the eastern shoreline to improve access to the project area for personnel, equipment and material transportation trucks will be conducted. These construction activities would include improving and/or creating access roads by using fill, gravel and geotextile over the existing landscape. A project compound with office trailers, support structures and associated electrical power and utilities would be required. Protective fencing would also be installed to restrict access to the work areas by unauthorized personnel. In accordance with the Memorandum of Agreement between Dominion, SHPO and the USACE these activities will not affect known cultural resources. Layers of geotextile, gravel and fill will be placed above the existing ground surface to level areas as need. An archaeological monitor will be present during site preparation to ensure that no significant cultural resources are impacted by construction.

Due to the varying thickness of sediment, the uneven nature of the riverbed and changing conditions within the project area a number of different methodologies and equipment may be employed to complete the project. Generally speaking, heavy equipment/machine excavators coupled with vacuum removal or other techniques will be employed to remove the sediment to as necessary. The removed sediment will be stored on-site for screening, visual examination and artifact recovery. In order to minimize potential impacts on spawning migrations for threatened and/or endangered species a construction phase (for actual work in the river) would begin no earlier than May and need to end by October. Because the removal areas will be isolated from the river through the installation of cofferdams, work within the cofferdams after installation may extend beyond this timeframe although the potential for overtopping events increases.

ARCHAEOLOGICAL SIGNIFICANCE

On February 17, 1865 General Sherman's troops captured Columbia. During the two day occupation, live munitions and other weapons of war housed at the Palmetto Armory were dumped into the Congaree River near the Gervais Street Bridge. According to Civil War Records:

A detail of 500 men each from the First and Second Brigades, properly officered for fatigue duty, together with the pioneer corps and fifty wagons, reported to Captain Buel, chief ordnance officer, to destroy public works, machinery, ordnance, ordnance stores, and ammunition, of which there were large quantities.

General John. E. Smith

According to General Smith it took 1200 men and 50 wagons from 1 P.M. February 18 to 6 P.M. February 19 to destroy the machinery, ordnance, ordnance stores and ammunition. Figure 3 provides a list of the ordnance captured.

Soon after Union troops departed Columbia ordnance recovery began. The accounts of J. F. Williams indicated that industrious citizens of Columbia were quick to salvage powder from the boxes of paper cartridges that had been left on the bank and for years after the war people would dive into the river and recover cannon balls and shells (Williams 1929).

Newspaper articles dating to the 1930s and more formal recovery attempts conducted in the 1970s and 1980s provide supporting evidence that Civil War ordnance is still present in the river. In June 1930, *The State* reported that two fishermen recovered ammunition from the area of a small tributary near the base of the Gervais Street Bridge. The discovery motivated New Brookland Mayor L. Hall and Councilman D. A. Spigner to organize a project to recover the artifacts. Their recovery was extensive and labor intensive. A coffer dam was erected approximately where Senate Street terminates at the river. After digging through the mud and silt the project collected six 10-inch cannonballs, 1,010 round rifle balls, 767 pointed rifle balls, a number of cast-iron copper fused explosive cannon shells; and cast iron lead butt explosive shells; three cast-iron cannon balls; one brass cap explosive, 11 3½-inch round cannon balls, 51 2-inch cannon balls; 2 6-inch cannon balls; 3 3½-inch time fuse explosive bombs; and an artillery axe (*The State* 1930). According to the article Hall and Spigner believed they had recovered practically all the ammunition that was deposited in the river. Based on the inventory presented in Figure 3, however, the 1930s recovery accounts for only a fraction of what may be present.

Eight years after the Hall and Spigner conducted their recovery, the *Spartanburg Herald* reported that two New Brookland high school boys found an artillery projectile in the Congaree River. The boys, Luther J. Morris and Knowiton Jeffcoat, apparently attempted to melt lead out of the round causing a minor explosion that brought the find to the attention of New Brookland authorities (*The Spartanburg Herald* 1938).

Beginning in the 1970s a number of formal recovery and salvage projects have been conducted at the sites. A majority of these projects have been conducted with licenses provided by the South Carolina Institute of Archaeology and Anthropology (SCIAA) under the Underwater Antiquities Act, providing a precedent for conducting the currently proposed project under a similar Salvage License. In the winter of 1976 an acoustic survey in the Congaree River below

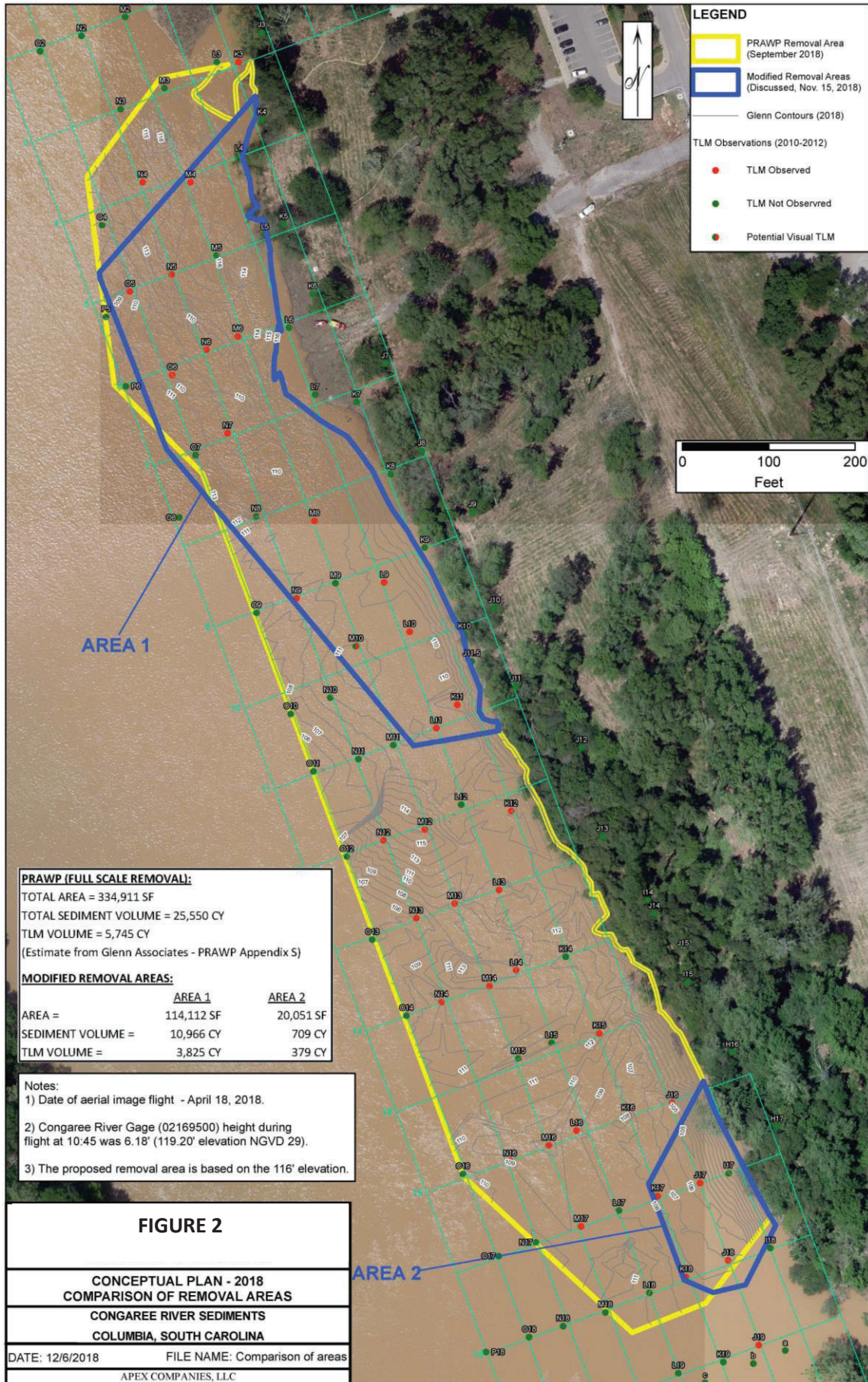

Figure 2. Extent of the proposed capping project.

the Gervais Street Bridge was conducted to identify concentrations of ordnance and artifacts. Although conditions were not ideally suited for an acoustic survey the project identified a concentration of ferrous material below the Gervais Street Bridge (Finkelstein 1976).

<i>Inventory of ordnance and ordnance stores captured in Columbia, S. C., February 17, 1865.</i>	
Ball cartridges (no caps).....	1,200,000
Percussion caps.....	100,000
Powder..... pounds.....	26,150
12-pounder gun ammunition, fixed..... rounds.....	1,007
6-pounder gun ammunition, fixed..... do.....	3,852
24-pounder gun ammunition, fixed..... do.....	546
8-inch shot and shell..... do.....	2,364
10-inch shot and shell..... do.....	1,320
Stands of arms.....	10,410
Unfinished arms.....	6,000
6-pounder guns.....	14
James guns.....	2
12-pounder mountain howitzers.....	5
Blakely guns.....	4
18-pounder rifled guns.....	3
Wiard gun.....	1
3-inch rifle.....	1
10-pounder guns.....	2
4-inch gun.....	1
4-inch mortars.....	2
6-inch Coehorn.....	1
Bronze guns, caliber 1½ and 2 inches.....	4
4-inch gun, smooth-bore.....	1
10-pounder Parrotts.....	2
Repeating battery.....	1
Gun carriages.....	9
Gun caissons.....	14
Gun (mountain howitzer) caissons.....	3
Forges.....	2
Anvils.....	4
Blacksmiths' vises.....	20
Sponges and rammers.....	1,125
Sabers, cavalry, artillery, and naval.....	3,100
Saber knots.....	700
Pairs cavalry pistol holsters.....	300
Saber belts.....	800
Bayonet scabbards.....	4,000
Cartridge-boxes (infantry).....	5,150
Cartridge-box plates.....	3,500
Cartridge-box belts and plates.....	2,500
Waist-belts.....	2,900
Waist-belt plates.....	3,000
Ball screws.....	2,000
Pistol cartridge-boxes.....	550
Gunners' shot-pouches.....	600
Knapsacks.....	1,100
Haversacks.....	900
Slow match..... yards.....	500
10-inch fuses.....	900
Tents.....	58

PHILIP MacCAHILL,
Lieut. and Actg. Ordnance Officer, First Div., Fifteenth Army Corps.

Figure 3. Inventory of ordnance captured during the occupation of of Columbia.

Under a salvage license issued in 1980, diver Gerald Mahle discovered a cache of 10-inch cannon balls at the site. Mahle and his team estimated that 50 to 100 additional shot lay in the river. However, by the time they were able to return to the river divers associated with the Savannah River Dive Club in Hampton, South Carolina had removed the ordnance (Salvage License No. 26 file SCIAA).

Mahle continued work under the SCIAA permit from February through September 1981. Using a dragline, a backhoe and a gold dredge, Mahle and his team removed and screened sediment from the river bed and apparently the alluvial fan near the foot of Senate Street. Fieldwork resumed in August 1981 using the backhoe for excavation. The project recovered numerous Civil War

artifacts including a 3.5-inch shell, a 24-pound cannonball, two 10-inch shells and a post-Civil War projectile. Apparently, the work did not produce sufficient material to justify continuation of the project (Salvage License No. 26 file SCIAA).

In 1983 a SCIAA Salvage License was issued for a metal detecting survey in the Congaree immediately south of the Gervais Street Bridge. Recovered artifacts associated with the Armory consist of 12 explosive shot for a 6-pounder cannon and one explosive shot for a 4-pounder (Salvage License No. 30 file SCIAA). Since the 1980s there are anecdotal reports of Civil War related artifacts being discovered in the river and on the alluvial fan at the terminus of Senate Street but there have been no additional formal recoveries. The site was designated 38RD286.

Based on this information, there is sufficient documentary and formal survey evidence to establish the continuing presence of ordnance in this section of the river. With this in mind a series of magnetometer and side scan sonar surveys were conducted in advance of the Congaree River Sediment Clean-up project to determine the possible extent of ordnance within the contaminated area.

Over a period of 18 months, from 2010 to 2012, Tidewater Atlantic Research, Inc. conducted remote sensing surveys within the course of the river and on the eastern bank (Tidewater Atlantic Research 2010, 2011a, 2011b, 2012). The first phase of this work focused on the area from the Gervais Street to approximately 1500 feet downstream. The magnetometer survey identified 218 anomalies that were consistent with unexploded ordnance (UXO). Phase II of the survey began where Phase I ended and extended another 400 feet downstream. Ten anomalies that could be could represent UXO were identified in this phase. Phase III of the survey focused on the area from Unnamed Tributary 2 (as seen in figure 1) to just south of the Blossom Street Bridge. One hundred and twenty-two hits consistent with potential ordnance were recorded in this phase. Phase IV was the continuation of a terrestrial metal detector survey along the river bank and alluvial fan at the end of Senate Street. An additional 67 potential instances of UXO were recorded along the shoreline. Attachment A provides a summary of magnetic anomaly survey along with a map detailing the precise locations of the possible UXO.

The Historic Columbia Canal was breached during the October 2015 flood event. This breach deposited a significant amount of sediment on site 38RD286 that potentially contains artifacts related to the construction of the canal. A portion of this newly deposited material will be removed during the project. This sediment will be screened and examined for artifacts. If artifacts are recovered an attempt will be made to determine whether they are related to the canal or to site 38RD278, an underwater resource that may be related to a possible mill site.

SCOPE OF WORK

The following Scope of Work outlines our approach to artifact recovery and conservation at the Congaree River Project. The design will outline the goals of the salvage project followed by a detailed methodology for the proposed stages of artifact recovery. Laboratory and artifact conservation methods will be outlined and initial plans for project deliverables, public outreach and the final disposition of the artifacts will be discussed.

PROJECT GOALS

Historic documents, previous salvage projects and intensive remote sensing surveys have confirmed the presence of artifacts related to the burning of Columbia and destruction of the stores at the State Armory in 1865. This previous work has also established that ordnance in the river may not possess locational or depositional integrity. In other words, the location of the artifacts may not be able to provide any pertinent or useful information as allowing interpretation of intra and inter-site feature patterns or depositional positioning however, grid recovery and unexploded ordnance recovery will provide information on depositional positioning. The main goal and value of this project is the recovery of the artifacts and their final inventory and analysis. Secondary goals of the project will be to document the TLM as a man-made artifact and address the events that led to its deposition in the river, determine if there are artifacts related to the Columbia Canal and make a formal evaluation of Site 38RD278, an underwater resource that is also within the project boundaries. The Project is designed in such a way that the removal of sediment that may contain significant artifacts will be necessary. Recognizing the presence of artifacts invaluable to the history of South Carolina and the nation, recovering them has become a priority to Dominion. Because of the lack of depositional integrity and the nature of the remediation project, the recovery of artifacts will focus on salvage and collection of as many artifacts as possible rather than the collection of traditional archaeological data.

In addition to satisfying salvage objectives and essential rescue of artifacts that would otherwise be confined to a landfill, it is expected that the cataloging of the ordnance will provide substantive contributions to the archaeology of the Civil War. Archaeological inquiry applied to this collection will not only corroborate or refute the historical record but ideally also provide what Smith (1994) describes as the relevant facts upon which to build the discipline of Civil War archaeology. This is vital in defining history because historical records are often confusing, disorganized, contradictory, incomplete, and biased (Smith 1994). For example in Sherman's memoirs he mentions that the ordnance from the Columbia Armory:

...were hauled in wagons to the Saluda River, under the supervision of Colonel Baylor, chief of ordnance, and emptied into deep water, causing a very serious accident by the bursting of a percussion-shell, as it struck another on the margin of the water. The flame followed back a train of powder which had sifted out, reached the wagons, still partially loaded, and exploded them, killing sixteen men and destroying several wagons and teams of mules. (Sherman 2006: 443)

We know from other historic documents that it was the Congaree River and that one commissioned officer (Captain William Davis, whose tombstone stands in Florence National Cemetery, Florence, SC) and three enlisted men (Jesse Johnson, James Kilpatrick and Coleman Wright) were killed by the explosion. By drawing on both the historical record and archaeological evidence a more informed account of the past will be established. Consequently, the data gathered during each phase of this project will be used as far as possible to address research questions specific to this site as well as pertinent to Civil War archaeology in general. These include the following topics:

- A comparison of the reported inventories and the collected material;
 - The 1930 salvage inventory lists an “artillery axe”, which is presumably a pickaxe or axe carried by a caisson. No axes are listed in the official Civil

War inventories. Are there items in the river that were not identified in the historic inventories?

- Identification of different styles and types of ordnance and ammunition;
 - During the Civil War more varieties of artillery were used than in another conflict in history. Can it be determined if the ammunition present was created at the Columbia Armory?
 - Are there shells and munitions present that were shipped to Columbia during this latter stage of the war from other armories?
 - Can an evolution or timeline of ordnance types be identified?
 - Are there shells from the beginning of the war as well as well as more technologically advanced material from later in the war?
- Identification of military rank or distinction between the quality of side arms, personal weaponry and miscellaneous items that may be deposited in the river;
 - At the start of the war high quality French and British arms and armaments were purchased and utilized by officers. Are examples of these weapons present?
 - Were higher quality items appropriated and distributed to Union troops during the initial destruction of the State Armory or were all items deposited in the river?
 - Reports indicate that muskets and sabers were destroyed at the site of the Armory itself. Might any of these destroyed weapons have made it to the wagons that were depositing material in the river?
 - A number of side arms and weapons were present at the Citadel Arsenal Academy and listed on some inventories of the captured and destroyed items from Columbia. Did any of these items make it into the river and can it be determined if they were cadet issued items?

FIELD METHODS

Based on previous archaeological work conducted at manufactured gas plants (e.g., Cherau and Bannister 2006; Stratton et al. 2004; Warren et al. 2002) and consultation with Dominion on the nature of the project the following recovery plan for this unique project is proposed. Artifact recovery will take place in two different locations (see Figure 2) pending the disposition of the material: *in situ*, an on-site processing station, and if necessary, an off-site location. The flow chart presented in Figure 4 provides a guide to how artifacts will be identified and recovered at various locations during the course of the project. All sediment removed from the project area will be evaluated as to its level of TLM contamination. Sediment determined to be lightly impacted or “clean” will be sent to the on-site screening facility for sorting and artifact recovery. Sediment determined to be too viscous to effectively screen will be sent to an off-site location where it will be spread out in thin layers and subject to visual inspection and/or metal detecting to facilitate artifact recovery. It is expected that reviewers and monitors from SCIAA and SHPO will periodically visit the recovery operations and provide feedback on the recovery methods.

Removal of the sediment will be conducted in controlled sequences, within a limited area per sequence. Each area will be marked and numbered on an overall project map. Sediment from each open area will be removed by backhoe or other equipment, as needed, and temporarily staged prior to loading or placed directly into a truck for transport. The truck will transport the

sediment to the on-site sorting area where it will be deposited. The piles will be marked as to their recovery location and a visual boundary will be utilized to the extent practical to segregate material from differing locations. Each pile will be examined for artifacts. Removing the soil in this way accomplishes two goals. It provides an organized system that expedites the removal of contaminated soil. It also provides additional provenience for use in assessing the distribution of the artifacts.

The overarching goal of the project is the timely removal of the contaminated soil rather than the recovery of the artifacts themselves. As stated earlier the material in the river possesses no depositional context. Locational information for the artifacts will not result in the identification of any patterns or organizational system that can be applied to any other Civil War site or archaeological context. Given these facts, sediment removal in controlled sequences within limited areas constitutes a practical method that will facilitate recovery and processing of the materials and artifacts.

In Situ Recovery/Ordnance Removal Demonstration

In October 2015, an *in situ* recovery of artifacts present on the alluvial fan found at the terminus of State Street (see Figure 2) was conducted. The recovery was a demonstration phase that tested project methods for ordnance and artifact removal and provided preliminary information on the type and quantity of artifacts that were submerged in the river. The demonstration/testing phase was primarily conducted by the UXO contractor and supported by archaeologists. This recovery was terminated early due to historic flooding that resulted in a breach of the Columbia Canal, immediately upstream from the site. No Civil War related materials were recovered during the limited recovery project.

On-Site Recovery

Heavy equipment will be utilized to remove the sediment. If saturated the soil will be either be placed in roll off containers or in discrete piles. It will then be allowed to dry (or processed with a drying agent such as cement dust) in preparation for transport. At the time of the removal a project manager familiar with the excavation and characteristics of TLM will assess the soil and make a determination whether the soil is too contaminated to pass through a screen. If the soil is “clean” it will be transported to the on-site artifact processing area (Figure 4) and screened for artifacts. Once in the processing area soil will be stored in discrete piles based on grid square. The soil from each grid square will then undergo the screening process. The screening process may be conducted through various methods dependent on the type of soil and artifacts present. The first possible method will be to sort the material with Bobcat outfitted with a skid steer rock bucket attachment that has finger tines spaced 4 inches apart (Figure 5). The rock bucket will be used to remove items, including modern debris (tires, bottles, etc.), over four inches in diameter. It is assumed that any potential ordnance over four inches will be recovered with this method. All material that does not fall through the tines will be visually inspected before being loaded

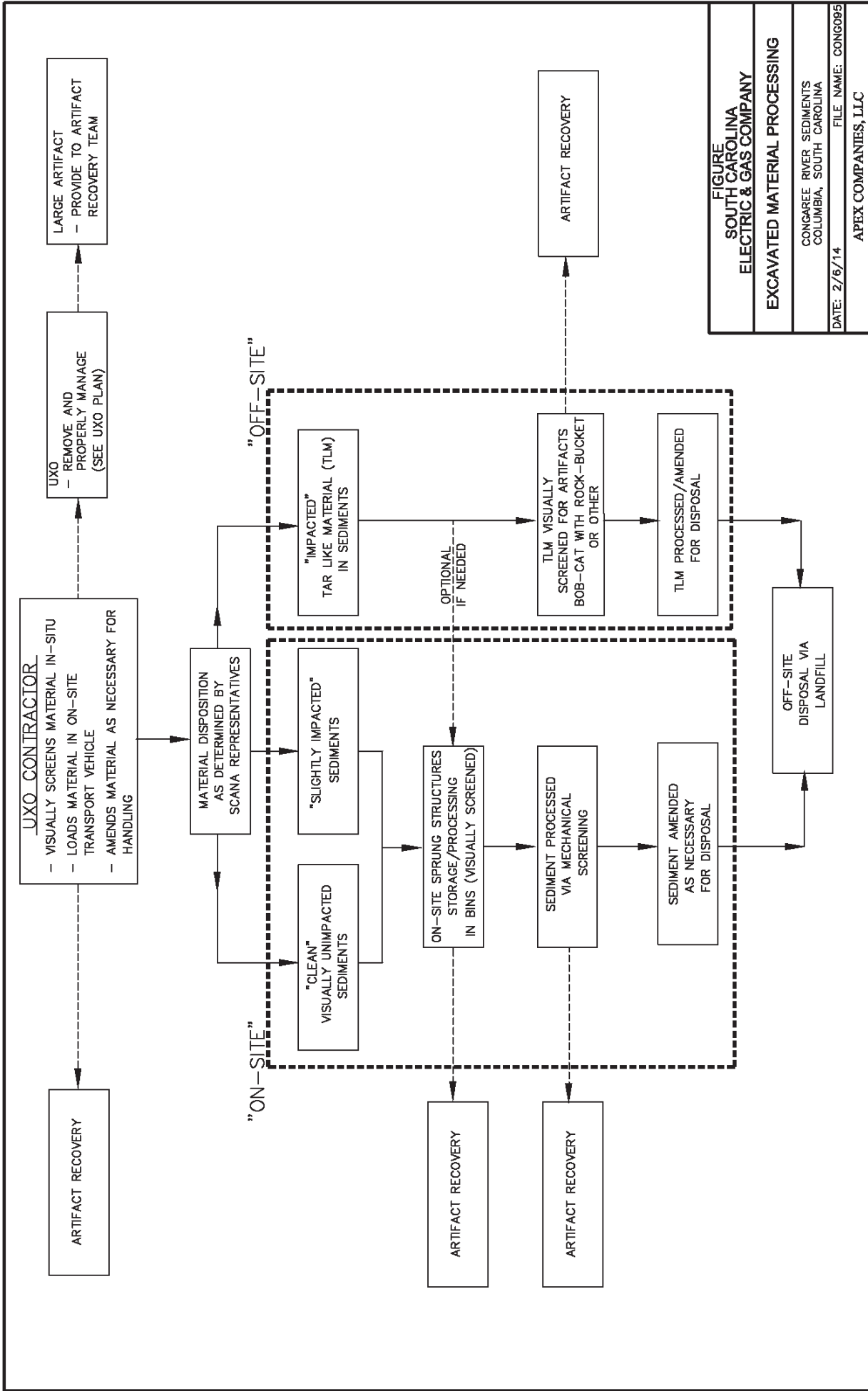

Figure 4. Process for recovering artifacts during sediment removal.



Figure 5. Example of a rock bucket to sort larger artifacts and sort rocks and debris.

into a roll off container for removal to the landfill. Any larger artifacts identified during this phase will be set aside for processing. If an artillery shell or potential UXO is identified safety protocols will be implemented and the UXO contractor and SCIAA will be immediately notified. Material that falls through the tines of the rock bucket may be subject to a second sort through a narrower gauge 2-inch bar sorter (Figure 6) similar to those used to sort rock and gravel. Material that does not fall through the bars will be visually examined. This sort is designed to recover items smaller ordnance and items or fragments of items that may have been broken up prior to disposal in the river (sabers, rifles, side arms, tools, buckles). The castoff material will be place in roll-off containers for disposal.

The remaining material will be taken to a screening and sorting station. This final stage of on-site recovery will be designed to recover the smaller artifacts. The soil will be sifted through various methods depending on the nature of the material and amount of time available for recovery. Options include ½-inch or ¼-inch mesh screens set up on sawhorses where the sediment can be manually screened. Water screening stations, metal detecting and standard archaeological shaker screens are also options. Artifacts recovered on-site will be bagged and labeled according to grid square and any other pertinent provenience.

Off-Site Recovery

The viscous nature of the TLM in the river requires a creative solution to artifact recovery. Above a certain threshold of TLM in the sediment screening will result in clogged mesh, soil consolidating into large tar balls and ineffectual artifact recovery. The amount of contaminated soil removed from the site is expected to be minimal. If possible the contaminated sediment will be processed on site. If the quantity of contaminate soil is greater than expected the odor it

produces may necessitate the need for an off-site processing location. The Columbia landfill has tentatively been identified as the off-site recovery location. The examination of contaminated soil will take place visually and through geophysical methods.



Figure 6. Example of a bar sorter

When it arrives at the off-site facility the soil will once again be stored according to grid location. An area measuring up to 50 feet by 50 feet (final dimensions will depend on the amount of open land available) will be covered with heavy, industrial plastic sheeting. A backhoe will be used to spread the sediment from a selected grid square in a thin layer, up to 2 inches thick, on the sheeting. Five-foot-wide lanes will be established across the examination area. A crew of archaeological field technicians will then walk the lanes and make a visual survey of the sediment collecting artifacts as they are encountered.

In the early stages of the recovery process a metal detector will be employed on every other lane. A comparison will be made of the amount and type of artifacts recovered from the metal detected lanes and the visually inspected lanes. If there is a large discrepancy the method found to recover the most artifacts will be employed throughout the remainder of the project. If there is no discernable difference the method found to be the most effective use of time and personnel will be the procedure of choice for the project.

Artifacts recovered from this facility will be more contaminated. They will be safely bagged, labeled and stored until they can be effectively cleaned and conserved.

Recovery Conclusions

If reported inventories are correct nearly 1.5 million items were potentially discarded into the river over a two-day period. Official recovery projects account for around 2000 of those artifacts. Unofficial recoveries dating back to the Civil War have likely accounted for thousands if not tens of thousands more. That only accounts for a fraction of the potential material that may be present. Since only a small portion of the site will be subject to recovery the proposed plan is focused on recovering as many artifacts as possible. Visual examination and bar screening are expected to identify larger artifacts. Smaller items like Minié balls, round shot and percussion caps will be collected through standard archaeological screening. Artifacts not related to the Civil War and of a smaller size, including prehistoric tools and projectiles, prehistoric ceramics, and historic artifacts dating from the populating of Columbia to the early twentieth century, will be collected with the proposed strategy. While these artifacts are not the primary focus of the salvage every effort will be made to recover significant diagnostic material.

ARTIFACT ANALYSIS AND CONSERVATION

Civil War documents indicate that artifacts recovered during this project may include lead ammunition, rifle barrels and wood stocks, percussion caps, sabers and cutlasses, artillery shells, cannons, scabbards, and munitions containers. Other artifacts may be present in addition to the military artifacts. There are a number of sites adjacent to the project area, including a 19th century sawmill and a possible ferry crossing (Figure 8). Likewise, prehistoric Native American artifacts have been recorded as being present on the shoreline adjacent to the project area. Artifacts from these sites may have eroded or been deposited into the river and may be present in the project area as well; the condition of potential artifacts from these sites is unknown.

The Artifact Analysis and Conservation Plan has been designed to accommodate this broad range of materials. The laboratory operations from the time a specimen is delivered to its ultimate place of storage or exhibition can be separated into five basic stages:

1. Initial documentation.
2. Storage prior to conservation process.
3. Encrustation removal.
4. Analysis.
5. Curation.

Initial Documentation

As an artifact is recovered, it will be bagged, labeled and recorded on the site log sheet documenting its associated unique provenience number (grid square). In this manner the recovered material can be roughly tracked and artifact density information by proveniences can be monitored. Inert and defused materials recovered during the in situ/ordnance removal phase will be similarly bagged and labeled according to grid square.

At this stage artifacts may be lightly washed or dry brushed to remove excess sediment and TLM. Based on information provided by Dominion, some artifacts may be entirely encased in TLM. The time and effort needed to clean and conserve these artifacts may be cost prohibitive. Depending on the information collected as the project goes on, it may be appropriate to propose sorting criteria based on the amount of tar affecting an artifact and the type of artifact as part of the conservation plan. For example if thousands of rounds of ammunition are recovered and found to be entirely encased in TLM an initial cleaning might remove as much material as possible, the lab crew would add the artifact type, quantities, and description to the field excavation forms and the items (or a percentage of the items) would be discarded. The details of a triage procedure such as this will be determined through consultation with Dominion and SCIAA personnel.

Storage Prior to Treatment

Removal of TLM will take place at this stage. In order to remove potentially hazardous contaminants artifacts will be lightly brushed and bathed in a solution of BioSolve. This is a water-based, biodegradable formulation of surfactants and performance additives. It is used in soil remediation projects and been found to be effective in cleaning oily residue and TLM from heavy equipment used in MGP remediation projects. This process will likely take place in TRC's Treatability Lab in Greenville, SC or in a designated area at the on-site processing facility where contaminants can be disposed of with the overburden.

Once the TLM has been removed the artifacts will be stored and conserved according to methods outlined in *Methods of Conserving Archaeological Material from Underwater Sites* (Hamilton 1999). Due to the potential volume of artifacts it is anticipated that some materials may need to be stored for a time before they can be properly cleaned and conserved. As part of this storage stage any adhering encrustation or corrosion layers will largely be left intact until the objects are treated, since they form a protective coating which retards further corrosion. Therefore all metal objects determined to be suitable for analysis will initially be kept in tap water with an inhibitor added to prevent further corrosion. For long-term storage, an oxidizing solution of potassium dichromate and sodium hydroxide or an alkaline inhibitive solution may be used (Hamilton 1999).

Encrustation Removal/Conservation

For most metal items, this will consist of thorough reduction in electrolysis, alternating with manual cleaning. After the rust has been removed, the artifact will be boiled in distilled water to remove salts, and then dried. The artifacts will finally be sealed with microcrystalline wax. Non-ferrous or fragile items may be treated by boiling in distilled water, drying, and sealing. Below are more details of possible cleaning and conservation methods based on expected material types.

IRON/FERROUS OBJECTS

Iron artifacts will be stored in an aqueous solution until they are subject to electrolysis. Electrolysis will take place in tanks specially equipped with a battery charger and a copper pipe; alligator clips are used to suspend the artifacts in a solution of tap water and sodium bicarbonate. A low voltage electric current is passed through the tank, removing the rust from the artifacts.

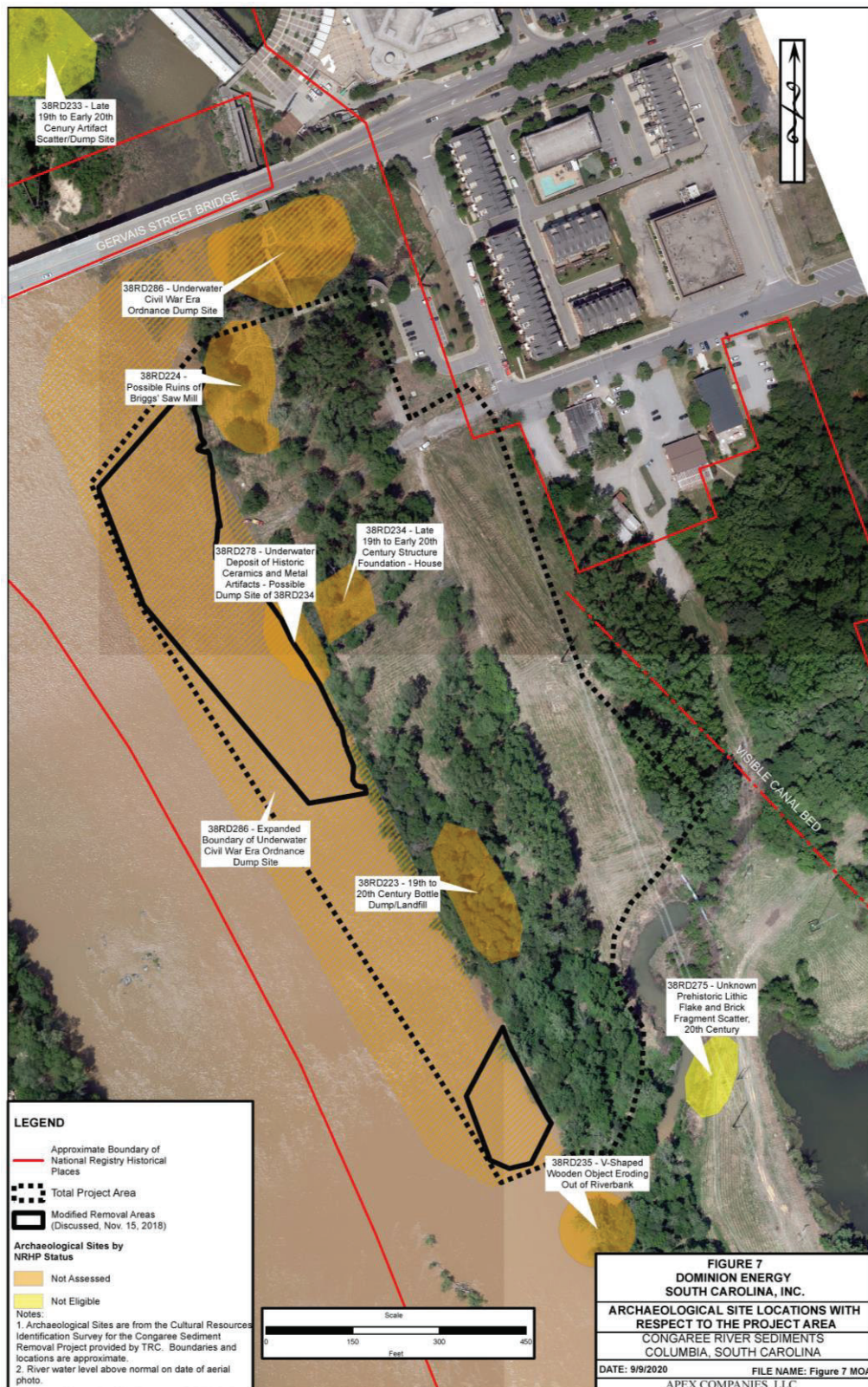

Figure 7. Previously recorded archaeological sites in the vicinity of the project area.

Electrolysis is continued in the tap water electrolyte until the chloride level of the electrolyte approximates the level found in the tap water. The artifacts will remain in the tanks for as long as it takes to remove all rust.

The artifact is then rinsed thoroughly in several changes of alternate boiling and cold de-ionized water to remove any residuum. The artifact will be submerged in the last vat of rinse water for a minimum of 24 hours. After rinsing, the moisture absorbed by the artifact must be removed before any sealant is applied. The artifact may be baked or if exposure to air is found to cause too much oxidation the object may be submerged in water-free isopropanol to dehydrate for a minimum of 24 hours. It may also be expedient to eliminate the drying process altogether and simply towel off the artifacts before dipping them in microcrystalline wax (Hamilton 1999). If larger object such as cannons are recovered a wax sealant may not be feasible. In such a case coats of polyurethane or Rustoleum may be appropriate.

LEAD

A majority of the artifacts recovered will presumably be made of lead. Lead will initially be stored in a tap water and sodium sesquicarbonate solution. In the case of lead artifacts, use of electrolysis is minimal. The lead will be immersed in 10 percent hydrochloric acid, which will remove any adhering marine encrustation, along with lead carbonates, lead monoxide, lead sulfide, calcium carbonate, and ferric oxide. This will be followed by a rinsing and gentle removal of adhering materials. Lead objects will be allowed to dry and finally sealed with microcrystalline wax.

COPPER, BRONZE AND BRASS

Artifacts made of copper and its alloys will be subject to the same electrolysis procedures as described for iron. The main variations in treatment involve the fact that the duration of electrolysis for cupreous objects is significantly shorter than that for comparable iron objects. Small cupreous artifacts, such as coins, require only a couple of hours in electrolysis (Hamilton 1999). Following electrolytic cleaning, the artifacts will be put through a series of hot rinses in de-ionized water until the pH of the last rinse bath is neutral. Because copper tarnishes in water, a wet paste of sodium bicarbonate may be used as polish. After polishing, a coat of benzotriazole (BTA), commercially known as KrylonClear Acrylic Spray will be applied.

WOOD

Waterlogged wood artifacts in the form of gun stocks, pistol butts or wagon/caisson wheels or parts may be recovered. Wood artifacts will be assessed as to their preservation potential and either discarded after being documented or submerged to await conservation. If wood is to be conserved it will be done with the Polyethylene glycol (PEG) method. This process simultaneously removes water from the object while also strengthening and consolidating the wood. The procedure is simple but time consuming. The wood artifact is placed in a solution of PEG and water or alcohol where it is allowed to sit. Over a period of months or years (depending on the size of the artifact) the PEG level is gradually raised until the solution consists of at least 70% PEG. At this level wood will remain stable and no further treatment of the wood should be necessary.

CERAMICS, STONE AND GLASS

Ceramic artifacts, stone tools or projectiles and glass objects that have been submerged in water do not typically require special treatment. Glazed and hard fired historic ceramics such as

stoneware and porcelain are impervious to water. Low fired earthenware and prehistoric ceramics may encounter some erosion but will remain structurally solid. Glass and lithic material may become discolored but will largely remain unaffected. Rinsing with tap water and light brushing to remove excess sediment is typically all that will be required. A mild detergent may be used in an attempt to remove deep stains. Care will be taken not to remove paint or surface treatments. The artifacts will then be allowed to air dry on rack. Reconstruction or re-fitting of vessel or container fragments may be attempted using proper fixatives. No sealant is required.

LEATHER

Leather conservation will follow the same procedures as detailed for ceramic items. Rinsing with tap water and light brushing to remove ingrained soil is typically all that will be required. If leather is waterlogged it can be subject to the same PEG treatment as wood. Treating leather with PEG will generally take less time than wood.

Analysis

Artifacts will be separated into functional groups that are then subdivided by use category and object type. The artifact pattern model, as devised by South (1977) and revised by Garrow (1982) is the basic formatting procedure for all artifacts. This model offers a rational approach for the organization of artifacts on a provenience to provenience level, or all the way up to total site contents. This system also allows for analytical modifications when collections of a specialized nature are recovered and was used to generate the functional categories outlined above for the Civil War artifacts.

This system will consolidate large quantities of like artifacts under descriptive headings and facilitate interpretation. A final and compelling reason to use the artifact pattern model is that it provides a good format within which to present the contents of the site, and can lead to cross-comparisons with other sites formatted in that manner. Functional groups, categories and sub-categories will consist of:

- Arms
 - Artillery
 - Cannons
 - Howitzer/Mortar
 - Ordnance - Fixed
 - Shot (24-pounder, 12-pounder, 6-pounder)
 - Case (24-pounder, 12-pounder, 6-pounder)
 - Fuse (24-pounder, 12-pounder, 6-pounder)
 - Grape (24-pounder, 12-pounder, 6-pounder)
 - Canister (24-pounder, 12-pounder, 6-pounder)
 - Ordnance – Not Fixed
 - Shot (10 inch, 8 inch)
 - Shell (10 inch, 8 inch)
 - Artillery Accoutrements
 - Carriages and parts
 - Caissons and parts
 - Tools
 - Fuses

- Firearms
 - Small Arms (pistols, pistol parts)
 - Small Arms Ammunition (shot)
 - Small Arms Accoutrements (holsters, belts, cartridge boxes, tools)
 - Long Arms (muskets, rifles, parts)
 - Long Arms Ammunition (shot, Minié balls)
 - Long Arms Accoutrements
- Edged Weapons
 - Sabers
 - Cavalry
 - Artillery
 - Naval
 - Bayonets
 - Cavalry
 - Edged Weapon Accoutrements
 - Saber knots
 - Saber scabbards
 - Bayonet scabbards
- Clothing
 - Button
 - Buckles
 - Insignias/Pins
 - Knapsacks
 - Haversacks
 - Other
- Tools
 - Anvil
 - Forge
 - Vise
 - Other
- Personal – Civil War
 - Jewelry
 - Writing
 - Food storage, preparation and consumption
 - Indulgence (alcohol and tobacco related items)
 - Medicine

Information recorded during the analysis of the Civil War related artifacts will vary depending on what objects are recovered. It is anticipated that a majority of artifacts recovered will be lead shot. These will be weighed and measured, perpendicular to the ball's mold seam, for diameter (*not caliber*) to 1000ths of an inch. The catalog description will include a conclusion regarding each shot's function based on its diameter or former diameter as implied by weight. Shot and shell will similarly be measured and weighed. Distinguishing characteristics that denote armory or metalworks of origin, and when possible range of manufacture, will be noted and photographed. Guns and fire arm parts as well as saber parts will be identified, photographed and cataloged.

Clothing items will be weighed and measured. Photographs will be taken. Detailed photographs of insignias or devices apparent on the durable clothing items will be documented and attempts will be made to identify insignias by military unit. Since their presence in the river is not necessarily documented and their recovery is not anticipated we are collapsing some material culture categories outlined by Legg and Smith (1989) into the single category of Personal Items. These items are items that would be in the possession of an individual soldier.

Historic artifacts will be analyzed by functional groups according to the procedures outlined in South (1977). Historic ceramic artifacts will be classified according to recognized types (e.g., pearlware, ironstone), and by decorative technique (e.g., hand-painted, transfer print, decal) and vessel form. Bottles are described by type, color, size, and closure type. Where possible, standard references such as Miller (2000), Noel Hume (1970), Jones and Sullivan (1985) and South (1977), as well as more specific published and on-line references for particular artifact types will be used to obtain date ranges for historic ceramics and glass.

The prehistoric artifact analysis will focus on identifying assemblages and/or technological attributes diagnostic of particular temporal and geographical cultural trends. The artifacts will be identified according to established regional types or styles. In the case of projectile points, morphological attributes will be used as typological markers. Ceramics will be typed according to paste, temper, and surface decoration.

The following descriptions define the categories in the lithic artifact typology to be used in the lithic analysis. Lithics refer to stone tools and debris from producing stone tools. The following categories are derived in part from those developed by Blanton et al. (1986) and Garrow (1982), which have been used with excellent success on many projects in South Carolina.

The two major groups of lithics are debitage and functional artifacts. Debitage can be divided into the following categories:

Biface Thinning Flakes. Biface thinning flakes are relatively thin and flat to slightly curved in cross section. Secondary flake scars are frequently present on the dorsal surface. The platform may be faceted and may exhibit a distinct lip, and the bulb of percussion is usually diffuse. These features are characteristic of soft hammer percussion, and the flakes of this type are most often the result of late stage biface reduction and maintenance.

Blades and Bladelike Flakes. These flakes approach or exceed a length-to-width ratio of 2:1. Blades and bladelike flakes frequently have a ridge oriented along the dorsal surface. They are typically manufactured for a specific purpose, such as replacing edges in cutting or grating implements.

Bipolar Flakes. Bipolar flakes exhibit a bulb of percussion on the ventral surface of both the distal and proximal ends. They are often curved in cross section. These flakes are manufactured by placing the raw material on a hard surface, such as an anvil stone, and striking its superior surface with a hard implement.

Unspecialized Flakes. These flakes are relatively thick and wide with little or no indication of having a particular function or representing a specific stage of manufacture.

Flake Fragment. This category includes those flakes that have only nondiagnostic medial or distal portions. Any flake lacking a proximal end will be placed in this category.

Shatter. Shatter is debitage that is angular and blocky. Specimens in this category cannot be oriented in relation to their proximal or distal end.

Chipping debris also will be subdivided based on the amount of cortex present on the dorsal surface. Classifications are assigned based on whether more than half (>50%), less than half (<50%), or no cortex was present on the dorsal surface. This measure should give an approximate indication of the stage of reduction represented in the assemblage. All lithic artifacts will be identified as to debitage class and raw material.

The second major lithic group is functional artifacts. The categories in this group are defined as follows:

Bifaces. This category comprises artifacts that are bifacially flaked and do not have haft elements. They can be finished tools, projectile points, knives, scrapers, or preforms. Bifaces usually cannot be given an established type name.

Hafted Bifaces. Hafted bifaces are bifacially worked artifacts that have a hafting element (i.e., stem and notches). They are often described as projectile points or knives and may conform to established type names.

Cobble Tools. Cobble tools are altered or unaltered cobbles used as hammerstones, nutting stones, anvils, and other similar tools.

Cores. Cores consist of parent raw material and are the remnants of flake manufacture. They can be blocky or discoidal in appearance and exhibit one or more flake scars.

Ground Stone. Artifacts in this category are manufactured by polishing or grinding stone into a desired shape—celts, axes, and manos, for example. These tools are often used in woodworking and food processing.

Manuports. Manuports are unaltered pieces of stone that are not indigenous to the area and obviously have been transported to the site by humans.

Retouched, Used, or Modified (RUM) Flakes. The category of RUM flakes includes all flakes that have been retouched into a unifacial tool, exhibit use wear, or have been modified by undetermined means. This category includes scrapers and utilized flakes.

Soapstone. Soapstone is a very soft stone that is easily worked. Artifacts frequently constructed of soapstone include bowls, pipes, and beads.

Fire-Cracked Rock. Although fire-cracked rock is not a tool per se, these are rocks that exhibit evidence of having been in or near a fire due to human activity. Alteration in color and/or luster, angular fractures, and pitted surfaces are diagnostic of fire-cracked rock.

The analysis of prehistoric sherds will begin with a basic characterization of the entire assemblage. Sherds smaller than 2 × 2 cm will be counted, weighed, and examined to determine the presence of surface treatments or vessel forms that could prove useful in the analysis. If not, they will receive no further analysis. All larger sherds will be classified by surface decoration and aplastic content. The aplastic content will be documented as the type (or raw material) and size of the major aplastics. Size will be determined through comparison with the Wentworth scale, used by most archaeologists to standardize aplastic descriptions. Aplastic size will be recorded as no apparent temper, fine, medium, coarse, and very coarse. Surface decoration will be recorded by type (e.g., incised), and major decorative mode characteristics will be recorded.

The preliminary analysis will allow a characterization of the sherd assemblage. During this initial analysis, sherds will be labeled and pulled for cross-mending, so the subsequent analyses can focus on the vessel assemblage. The surface decoration–aplastic content classes from the

preliminary analysis will be compared to published type descriptions; type names will be applied where possible.

Surface decoration, aplastic content, thickness, and interior surface treatment will be considered in cross-mending the sherds. The analysis will seek to reconstruct as many vessels as possible to help determine vessel form and function. The following attributes will be recorded for each vessel to provide a detailed technological description of the wares. They will be examined to determine technological patterns within and between types.

- Type, size, shape, and density of major aplastics
- Type and size of minority aplastics
- Degree of carbon core retention
- Sherd core cross-section configuration
- Thickness 3 cm below rim
- Rim form
- Presence of coil breaks
- Dominant paste color
- Interior surface treatment

Curation

Dominion realizes a disposition agreement with SCIAA regarding the percentage of artifacts to be received is required as part of the application process. Dominion is committed to displaying and making the artifacts recovered from this site available to the public. At the conclusion of the analysis the artifacts will be prepared for curation following accepted guidelines. Copies of all records, including, but not limited to, field notes, maps, catalog sheets, and representative photographs shall be submitted for curation with the artifacts. After project clearance has been obtained, artifacts and relevant notes will be curated in accordance with the selected repository. It has not yet been determined where the material will be curated, but it is anticipated that all or most of the Civil War related material will be curated at the South Carolina State Museum Confederate Relic Room. It is possible that due to the volume and type of material expected multiple curation facilities may be needed. The preference will be for the artifacts to remain in the state and local if possible. Options include the Cayce History Museum, The Cayce Historical Park and other state and local museums. Other curation options include the SC Office of the State Archaeologist Curation Facility. Moundville, Alabama Curation Facility.

DOCUMENTATION

Daily logs and records will be kept at each artifact processing area during the recovery phase. These logs will be available for review by COE, SHPO and SCIAA personnel during monitoring visits. Interim reports/management summaries will be provided documenting each phase of the remediation project. These management summaries will minimally include maps depicting the area cleared during the related field season, a description of the work completed to date, a preliminary inventory of the artifacts recovered and a status update that will provide detail of the next field season.

At the conclusion of the remediation project a draft technical report will be produced and delivered to review agencies. The report will follow the format and content specified in the *South*

Carolina Standards and Guidelines for Archaeological Investigations, including a description of past archaeological research in the project vicinity, a discussion of local history, an explanation of the research design, the field methods employed, evaluation methods, findings, conclusions, and recommendations. TRC will promptly address all comments and revisions provided in writing by SHPO and SCIAA in a final technical report.

All maps and drawings will be high quality and produced in a professional manner. Project maps will be produced in color using ArcGIS software, CAD or other appropriate mapping programs. These maps will depict each phase of the project and include grid square boundaries. Individual maps of grid squares may be used to identify the locations of ordnance removed during the UXO recovery stages of the project. Overlays of historic maps and plats may be used where appropriate. High quality color photographs or measured drawings, as appropriate, will be provided that show details of representative diagnostic or other interesting artifacts. The report will be bound in a durable cover (minimum 80 lbs cover stock), and contain an identifying label. The paper will be high quality laser printed paper, minimum 24 lbs stock, and will be acid free. Pages will be printed on both sides and project maps and photographs will be produced in color. Electronic copies of the final report in Adobe Portable Document File (PDF) format will be provided to SHPO and SCIAA and outside reviews as appropriate. In addition, a CD or DVD with photographs of the artifacts will be provided if desired.

At the discretion of Dominion, a popular report suitable for public distribution may be produced. This report may also be reviewed and commented on by review agencies prior to publication. This report, if produced, will be part of the public outreach program that Dominion is committed to in order to inform and educate the public on this significant find.

PUBLIC INFORMATION

Salvage of the Civil War material deposited in the Congaree River offers an amazing opportunity to educate and involve the public about a historically significant site. The recovery of tangible evidence of the capture of Columbia will take place almost exactly 150 years from when it occurred. There will be multiple opportunities for the general public to benefit from this project. Initial plans call for an on-site structure dedicated to exhibiting the history of the site, the on-going work and the interpretation of the artifacts. This structure will be open to the public and will tentatively be staffed by Dominion personnel and an archaeological docent.

An electronic presentation or social media site suitable for hosting by Dominion or other appropriate website may be created to present the on-going recovery process. Museum quality artifact displays and/or traveling artifact shows at museums throughout the state can be generated. A book/booklet depicting the artifacts and history of the site suitable for presentation to the general public can be authored. Additional public outreach may involve professional papers and presentations at national and regional archaeological conferences, tours and talks for school age children as well as avocational groups is also an option. Some or all of these potential public outreach approaches will be completed as a result of this project.

QUALIFICATIONS

Company Profile

A pioneer in groundbreaking scientific and engineering developments since the 1960s, TRC is a national engineering and consulting firm providing integrated services to the energy, environmental, and infrastructure markets. We serve a broad range of clients in government and industry, implementing complex projects from initial concept to operations. TRC employs over 2,600 technical professionals and support personnel at more than 70 offices throughout the U.S.

TRC's cultural resource group in the Southeast originated as Garrow and Associates, an Atlanta-based small business that was founded in 1983 and acquired by TRC in 1997. We offer a complete range of cultural resource services in the Southeast from our offices in Atlanta, Georgia; Chapel Hill, North Carolina; Columbia, South Carolina; and Nashville, Tennessee; including archaeological investigations, historic structure surveys and evaluations, and cemetery studies. Our local office in Columbia is within a ten-minute drive of the Congaree River Project site. With the Principal Project Manager and Key Project Team members being local to Columbia, we will be able to respond quickly to all Dominion's needs. Our office provides us rapid access to SCIAA, SHPO, the South Carolina Department of Archives and History (SCDAH), the University of South Carolina at Columbia, and other regulatory offices and research facilities. Our organizational depth will allow us to draw on resources from our nearby offices to support this project as needed.

TRC's core cultural resources staff in the Southeast consists of approximately 55 professional archaeologists, crew chiefs, preservation planners, historians, and support personnel. Our archaeologists possess M.A. or Ph.D. degrees in Anthropology, meet the Secretary of the Interior's standards, and are Register of Professional Archaeologists (RPA) certified or eligible.

Our Columbia office contains 2,400 square feet of laboratory, office, and storage space. It possesses wet lab and dry lab capabilities and has ample room to conduct electrolysis and metal conservation operations. TRC's Atlanta facility includes 2,500 square feet of fully equipped laboratory space that includes tanks capable of conserving metal objects up to four feet in length, and the Chapel Hill office has similar lab and storage capabilities. Our Greenville office contains a wet lab and research/treatability laboratories complete with ventilation hoods and resources for preparing and storing solvents for use in cleaning coal tar from artifacts.

Key Personnel

TRC's proposed key staff for the Congaree River Sediment Removal Project includes highly experienced researchers with extensive experience managing and directing large scale projects that require consultation with multi-disciplinary teams as well as state and Federal agencies. Our team also has experience with both complex projects that involve creative approaches to archaeological issues and with Civil War era projects that involve recovery and conservation of artifacts similar to those anticipated for the Congaree River Project.

TRC Columbia Program Manager Sean Norris, M.A., RPA, will serve as Principal Project Manager for the project. Ms. Ramona Grunden, Senior Archaeologist in our Columbia office will serve as the Assistant Project Manager.

Principal Project Manager

Mr. Sean Norris is the Program Manager for Archaeology at the Columbia Office of TRC. He handles administrative duties and manages all projects and contracts that originate in that office. Mr. Norris will serve as Principal Project Manager and will attend meetings with Dominion and other team members, lead the development of the Artifact Recovery/Salvage and Artifact Conservation and Stabilization plans, and act as TRC's point of contact for this project. Mr. Norris has over 15 years of experience in the eastern U.S. and is RPA certified. Mr. Norris has served as Principal Investigator on numerous projects in South Carolina and has experience in project planning, the development and implementation of research designs and field and laboratory methodologies, and technical and popular reporting. Mr. Norris is President of the Council of South Carolina Professional Archaeologists and routinely interacts and sits on committees with employees of SCIAA and the South Carolina SHPO. He has authored Memorandums of Agreement (MOAs) and Memorandums of Understanding (MOUs) as well as Protective Covenants for significant archaeological sites that have included the SHPO, SCDHEC, and the COE as signatories.

Assistant Project Manager

Ms. Ramona Grunden is a Senior Archaeologist and Laboratory Director in TRC's Columbia Office. She will serve as the Assistant Project Manager. Her duties for this phase of the project will include providing input on artifact recovery strategies related to Civil War sites, she will also be present to attend meetings should Mr. Norris be unavailable. Ms. Grunden has over 30 years of experience in South Carolina archaeology including seven years as an archaeologist at SCIAA. Ms. Grunden has conducted and managed numerous large-scale projects in the Southeast. She has extensive experience in all phases of historic sites investigations, and has worked on numerous Civil War projects and others involving military installations and military components.

Senior Technical Advisor

Mr. Paul Webb is TRC's Cultural Resource Program Leader, and is stationed in the Chapel Hill office. He has over 25 years of experience in cultural resource management, including planning, implementing, and reporting all aspects of cultural resource studies. His qualifications include extensive experience with large and technically complex archaeological projects, and in assisting multidisciplinary teams in developing creative approaches to cultural resource issues. Mr. Webb will assist in the development of the artifact recovery/salvage and conservation and stabilization plans, and will also assist in agency negotiations as appropriate. Mr. Webb's background includes service to public, tribal, and private-sector clients, including the North Carolina Department of Transportation; Federal Highway Administration Eastern Federal Lands Highway Division (FHWA EFLHD); National Park Service (NPS); National Forests in North Carolina; Eastern Band of Cherokee Indians; U.S. Army Corps of Engineers; U.S. Army Construction Engineering Research Laboratory (USACERL); U.S. Army Environmental Center; Maryland State Highway Administration; Iroquois Gas Transmission System; Duke Energy; Piedmont

Natural Gas; North Carolina Natural Gas; Spectra Energy; and Progress Energy; along with numerous engineering and environmental firms.

Laboratory Director

Mr. Thomas Garrow is the Laboratory Manager for TRC's Atlanta office, a position he has held since 1993. Mr. Garrow is responsible for artifact processing, analysis, conservation, and cataloging, as well as specialized recovery techniques such as flotation. Mr. Garrow has nearly 30 years of experience in cultural resource management, including field and laboratory work across the eastern United States. Mr. Garrow has participated in numerous archaeological investigations covering a wide range of site types, including those dating to the Civil War. Mr. Garrow has received training in artifact conservation techniques and curation standards, and few cultural resource practitioners in the region can match his depth of experience in metal conservation. Mr. Garrow will assist in development of the Artifact Recovery/Salvage and Conservation and Stabilization plans.

Senior Scientific Advisor

Dr. Karen Saucier has over 25 years of experience, and has worked extensively in the areas of CERCLA- and RCRA-mandated investigations, risk evaluations and remediations. Dr. Saucier will act as TRC's in-house technical advisor with experience on Manufactured Gas Plant sites. Her expertise includes providing strategic technical services, and assessing regulatory and business implications of environmental remediations and historic liabilities. Dr. Saucier supports client/agency negotiations with respect to risk-based decision making, sediment, soil and groundwater remediation approaches, and liability portfolio life-cycle costing and management. She routinely serves as Project Manager with responsibility for coordination and integration of multidisciplinary technical resources through the various stages of liability project life cycles. She advises on and leads project communications to corporate, regulatory and community stakeholders.

Additional Consultants/Staff

TRC will retain the services of Mr. James Legg as an archaeologist and consultant to assist in the General Consulting and planning tasks requested in this RFP. Mr. Legg currently works as a project archaeologist for SCIAA and has more than 40 years of experience in archaeological research involving battlefields and other military sites. He has worked with Ms. Grunden on a number of those sites. He has a particular interest in 18th and 19th century ordnance, including both small arms and artillery ammunition. He is a recognized expert who has handled all of the major types of Civil War ammunition and has disarmed and conserved many examples.

Mr. Legg has 32 years of experience in archaeological metal detecting, and has a regional reputation as an authority on the subject. Mr. Legg is also highly experienced in metal conservation. Over the last 35 years he has conserved several thousand metal artifacts from private collections as well as significant archaeological collections including those from 16th century Santa Elena, the Camden Battlefield, and a number of other projects conducted by SCIAA and other research entities.

REFERENCES CITED

- Blanton, Dennis B., Christopher T. Espenshade, and Paul E. Brockington Jr.
1986 *An Archaeological Study of 38SU83: A Yadkin Phase Site in the Upper Coastal Plain of South Carolina*. Garrow & Associates, Inc., Atlanta. Submitted to South Carolina Department of Transportation, Columbia.
- Cherau, Suzanne and Jennifer Bonner Bannister
2006 *Archaeological Investigations Chadwick Lead Mill Site, Salem and Marblehead, Massachusetts*. Public Archaeology Laboratory, Pawtucket, Rhode Island.
- Finkelstein, Charles
1976 *Sonar Survey of the Congaree River, Columbia, South Carolina*. Conservation Research Laboratory Center for Maritime Archaeology and Conservation. Texas A&M University. College Station, Texas.
- Garrow, Patrick H.
1982 *Archaeological Investigations of the Washington, D.C. Civic Center Site*. Soil Systems, Inc., Marietta, Georgia. Submitted to the Department of Housing and Community Development, Government of the District of Columbia, Washington, D.C.
- Hamilton, Donny
1999 *Methods of Conserving Archaeological Material from Underwater Sites*. Report to Bruce Hoverman, Columbia, South Carolina, from Massachusetts Institute of Technology, Cambridge, MA.
- Jones, Olive and Catherine Sullivan
1985 *The Parks Canada Glass Glossary*. National Parks and Sites, Ottawa.
- Legg, James B. and Steven D. Smith
1989 *The Best Ever Occupied...Archaeological Investigations of a Civil War Encampment on Folly Island, South Carolina*. Research Manuscript Series 209. South Carolina Institute of Archaeology and Anthropology, Columbia, SC.
- Miller, George L.
2000 Telling Time for Archaeologists. *Northeast Historical Archaeology* 29:1–22.
- Noel Hume, Ivor
1970 *A Guide to Colonial Artifacts of America*. Alfred A. Knopf, New York.
- Sherman, William Tecumseh
2006 *Memoirs of General W. T. Sherman*. Reprint of the 1889 revised and corrected second edition. Echo Library, Teddington, Middlesex, England.
- South, Stanley
1977 *Method and Theory in Historical Archaeology*. Academic Press, New York.

Smith, Steven D.

1994 Archeological Perspectives on the Civil War: The Challenge to Achieve Relevance. In Geier, Clarence R. and Susan E. Winter, editors. *Look to the Earth: Historical Archaeology and the American Civil War*. Knoxville, Tennessee: The University of Tennessee Press. pp. 3-20.

The Spartanburg Herald

1938 YOUNGSTERS TRY TO MELT LEAD FROM OLD WAR SHELLS: EXPLOSION ALMOST REOPENS CONFEDERATE CONFLICT. *The Spartanburg Herald* 5 January:1.
Spartanburg, SC.

The State

1930 Confederate Ammunition, Dug From River, To Go on Display in Columbia This Week. *The State* 3 June 1930:1. Columbia, SC.

Stratton, Susan K., Barry A. Price, and M. Colleen Hamilton

2004 Hazardous Site Archaeology: A Case Study of a Manufactures Gas Plant. *Proceeding of the Society for California Archaeology*, Volume 14 (pp 21-24)

Tidewater Atlantic Research, Inc

2010 *A Remote-Sensing Survey of the Congaree River Below the Gervais Street Bridge*. Submitted to Management and Technical Resources, Inc. Tidewater Atlantic Research. Wilmington, NC.

2011a *A Remote-Sensing Survey of the Congaree River Below the Gervais Street Bridge, Phase II Addition*. Submitted to Management and Technical Resources, Inc. Tidewater Atlantic Research. Wilmington, NC.

2011b *A Remote-Sensing Survey of the Congaree River Below the Gervais Street Bridge, Phase III Report*. Submitted to Management and Technical Resources, Inc. Tidewater Atlantic Research. Wilmington, NC.

2012 *A Terrestrial Remote-Sensing Survey of the Congaree River Below the Gervais Street Bridge*. Submitted to Management and Technical Resources, Inc. Tidewater Atlantic Research. Wilmington, NC.

Warren, Keith, Wendy Nettles, and Colleen Hamilton

2002 *Test Excavations and Evaluation of Historic Archaeological Resources at the Santa Barbara I Manufactured Gas Plant*. Applied Earthworks, Inc., Hemet, California.

Williams, J.F.

1929 *Old and New Columbia*. Epworth Orphanage Press, Columbia, SC.

ATTACHMENT A – SUMMARY OF UNDERWATER ANOMALIES

**MEMORANDUM OF
AGREEMENT**

**AMONG THE U.S. ARMY CORPS OF ENGINEERS, CHARLESTON DISTRICT;
THE SOUTH CAROLINA STATE HISTORIC PRESERVATION OFFICE; AND
DOMINION ENERGY SOUTH CAROLINA, INC.
REGARDING THE CONGAREE RIVER REMEDIATION PROJECT, RICHLAND
COUNTY, SOUTH CAROLINA**

WHEREAS, pursuant to Section 10 of the Rivers and Harbors Act of 1899 (33 U.S.C. 403) and Section 404 of the Clean Water Act (33 U.S.C. 1344), an application (P/N # 2011-1356-6IO) has been submitted to the U. S. Army Corps of Engineers, Charleston District (Corps) by Dominion Energy South Carolina, Inc. (Dominion) for a Department of the Army (DA) permit to authorize impacts to waters of the United States associated with the construction a cofferdam and removal of a Tar-Like Material that is comingled with sediment in the Congaree River, Richland County, South Carolina (undertaking), and

WHEREAS, the Corps has defined the undertaking's Permit Area as a 0.50-acre site, as illustrated in the Attached Figure 1; and

WHEREAS, the Corps has determined that the undertaking will adversely affect Archaeological Site 38RD286/38RD278 (the Ordnance Dump Site/historic underwater site), which is eligible for listing in the National Register of Historic Places and Archaeological Sites 38RD223, 38RD224, and 38RD234 (Figure 2); and

WHEREAS, the Corps has consulted with the South Carolina State Historic Preservation Officer (SHPO) and the South Carolina Institute of Archaeology and Anthropology pursuant to Section 106 of the National Historic Preservation Act (NHPA), as amended (54 U.S.C § 306108, previously codified at 16 U.S.C. § 470f); and

WHEREAS, the Corps has notified federally-recognized tribes about the Undertaking's anticipated impacts on historic properties, as required by 36 C.F.R. § 800.6; and

WHEREAS, the Corps has consulted with Dominion regarding the effects of the undertaking on sites 38RD286/38RD273, 38RD223, 38RD224, and 38RD234 and has invited Dominion to sign this Memorandum of Agreement (MOA) as an invited signatory; and

WHEREAS, the Corps has consulted with the SHPO and Dominion in accordance with Section 106 of the National Historic Preservation Act of 1966, as amended (54 U.S.C. § 306108, previously codified at 16 U.S.C. § 470f), its implementing regulations (36 C.F.R. Part 800), and 33 C.F.R. Part 325, Appendix C to resolve the potential adverse effects of the Undertaking; and

WHEREAS, in accordance with the USACE "Interim Guidance for Implementing Appendix C of 33 CFR part 325 with the revised Advisory Council on Historic Preservation Regulations at 36 CFR part 800" (Apr. 25, 2005); 33 C.F.R. Part 325, Appendix C, Par. 8.; 36

C.F.R. § 800.6(a)(1); and 36 C.F.R. § 800.6(b)(1)(iv), , the Corps has notified the Advisory Council on Historic Preservation (ACHP) of its adverse effect determination with specified documentation and the ACHP has chosen *not* to participate in the consultation pursuant to 36 CFR Part 800.6(a)(1)(iii);

NOW, THEREFORE, the Corps, the SHPO and Dominion agree that the undertaking shall be implemented in accordance with the following stipulations in order to take into account the effect of the undertaking on historic artifacts.

STIPULATIONS

The Corps will monitor the progress of the following stipulated tasks to ensure that the Undertaking is carried out in accordance with this MOA, and Dominion will ensure that the following stipulations are implemented:

I. INSPECTION

Dominion and any successors or assigns engaged in the removal of the contaminated sediment shall allow representatives from the Corps and the SHPO to inspect the authorized activity at any time that is deemed necessary to ensure that it is being or has been accomplished in accordance with the terms and conditions of this MOA. During any inspection the Corps and the SHPO will follow all safety protocols established at the work site.

II. PLANS AND REPORTS

All plans and reports developed for the salvage of historic artifacts shall incorporate guidance provided by the Secretary of Interior's *Standards and Guidelines for Archaeological Documentation* (48 FR 44734-37) and the President's Advisory Council on Historic Preservation publication, *Treatment of Archaeological Properties* (ACHP 1980). In addition, these materials will be consistent with *South Carolina Standards and Guidelines for Archaeological Investigations* (Council of South Carolina Professional Archaeologists, et al. revised 2013).

III. PROTECTIONS

Dominion's archaeological consultant will develop a recovery plan (Plan) for the portions of Archaeological Site 38RD286/38RD278 contained within the project area and identified in Attachment A. The recovery plan will include a description of the undertaking's research design and methodology for artifact recovery. The recovery plan will be submitted to the Corps and the SHPO for review and approval prior to any fieldwork. The Corps and the SHPO will be afforded thirty (30) days to review the recovery plan and provide comments.

Dominion will protect and preserve the areas labeled as Archaeological Sites 38RD223, 38RD224 and 38RD234 as shown in Exhibit A by completing the requirements stated in Stipulation IV below until such time as sites are determined not eligible for the

NRHP or potential adverse effects to those Sites determined eligible are mitigated with data recovery in accordance with this MOA and the Plan.

IV. SURVEY

No less than ten (10) days prior to any land disturbing activities Dominion shall ensure that:

- a. Archaeological Sites 38RD223, 38RD224 and 38RD234 are marked on construction and maintenance plans with treatment notes and this MOA referenced.
- b. All newly constructed roads in the vicinity of site 38RD223, 38RD224 and 38RD234 will be elevated above grade with successive layers of fill, geotextile matting and gravel in order to protect potential subsurface deposits.
- c. The boundaries of Archaeological Sites 38RD223, 38RD224 and 38RD234 are cordoned off in the field with orange safety fencing, or a similar highly visible barrier which shall remain in place until all construction activity is complete.
- d. An archaeologist will be present to monitor construction activities in the vicinity of Archaeological Sites 38RD223, 38RD224 and 38RD234.

V. COPIES OF DRAFT TECHNICAL REPORT

At least one copy of the draft technical report of data recovery operations and final public information plans will be submitted to the SHPO for review and approval within two (2) years from the last day of fieldwork. The draft technical report will be consistent with the standards outlined in *South Carolina Standards and Guidelines for Archaeological Investigations* (Council of South Carolina Professional Archaeologists, et al. revised 2013). The SHPO reserves the right to submit the draft technical report to qualified professional archaeologists for peer review. If the SHPO elects to utilize this option, Dominion's archaeological consultant will be advised, and additional report copies may be requested. If revisions of the draft report are recommended, Dominion is responsible for ensuring that these revisions are addressed in the final report. The final report will be submitted to the SHPO within three (3) months of the receipt of all agency and peer review comments.

VI. PUBLIC EDUCATION

Dominion, and the SHPO will consult to determine the appropriate format for a public education component. Dominion will ensure that a public education plan is developed and submitted to the SHPO with the draft technical report. All public education materials will be implemented within two (2) years of the last day of fieldwork.

VII. FINAL DISPOSTION

Dominion and the SHPO will consult to determine the final disposition of the artifacts recovered in accordance with the Underwater Antiquities Act of 1991 (Article 5, Chapter 7, Title 54, Code of Laws of South Carolina, 1976). Dominion will ensure that artifacts are stabilized and processed prior to their final disposition.

VIII. DURATION

This MOA will expire if its terms are not carried out within five (5) years from the issuance date of the DA permit, or when all stipulations are met, whichever comes first. Prior to such time, the Corps may consult with the other signatories to reconsider the terms of the MOA and amend in accordance with the “Amendments” paragraph below.

IX. POST-REVIEW DISCOVERIES

If any unanticipated cultural materials (e.g. large, intact artifacts or animal bones, large clusters of artifacts or animal bones, large soil stains or patterns of soil stains, buried brick or stone structures, or clusters of brick or stone indicating a former structure) in the project area prior to or during construction activities (a “Late Discovery”), then Dominion will temporarily halt any activities in the vicinity of such Late Discovery and will notify the SHPO and the Corps as soon as practical of the Late Discovery. The halt will afford the Corps and the SHPO the opportunity to assess the situation and recommend a course of action within two (2) business days after such notification.

A buffer will be established around the Late Discovery by the construction project manager. The buffer will be flagged by appropriate personnel and posted with signage indicating that no land altering activities will be allowed within this buffer zone until the course of action hereinafter described has been established.

If unanticipated human remains are found or suspected, they should be left in place and protected until appropriate consultation is completed. DOMINION is responsible for notifying the Corps, the SHPO, and the local authorities to initiate consultation. Human remains are subject to South Carolina law that addresses abandoned cemeteries and burials including but not limited to S.C. Code Ann. §§ 27-43-10 to 27-43-30, 16-16-600 and 61-19-28 to 61-19-29.

X. MONITORING AND REPORTING

Every one (1) year following the execution of this agreement, for the life of the agreement, Dominion will provide the Corps and the SHPO a written report describing all work begun or accomplished during the past year under this agreement. Such report shall include any scheduling changes proposed, any problems encountered, and any disputes and objections received relating to the efforts to carry out the terms of this MOA. Dominion will also report on plans for the next year. This report may be submitted to the Corps via e-mail and to the SHPO in hard copy format.

XI. DISPUTE RESOLUTION

Should any signatory to this MOA object at any time to any actions proposed or the manner in which the terms of this MOA are implemented, the Corps shall consult with such party to resolve the objection. If the Corps determines that such objection cannot be resolved, the Corps will:

- A. Forward all documentation relevant to the dispute, including the Corps' proposed resolution to the ACHP. The ACHP shall provide the Corps with its advice on the resolution of the objection within thirty (30) days of receiving adequate documentation. Prior to reaching a final decision on the dispute, the Corps shall prepare a written response that takes into account any timely advice or comments regarding the dispute from the ACHP and signatories and provide them with a copy of this written response. The Corps will then proceed according to its final decision.
- B. If the ACHP does not provide its advice regarding the dispute within the thirty (30) day time period, the Corps may make a final decision on the dispute and proceed accordingly. Prior to reaching such a final decision, the Corps shall prepare a written response that takes into account any timely comments regarding the dispute from the signatories to the MOA, and provide them and the ACHP with a copy of such written response.
- C. The Corps' responsibility to carry out all other actions subject to the terms of this MOA that are not the subject of the dispute remain unchanged.

XII. AMENDMENTS AND MODIFICATIONS

This MOA may be amended when such an amendment is agreed to in writing by all signatories. The amendment will be effective on the date a copy signed by all of the signatories is filed with the ACHP. Amendment of this MOA may require a concurrent request to amend applicable permits and easements of restrictive covenants.

XIII. TERMINATION

If any signatory to this MOA determines that its terms will not or cannot be carried out, that party shall immediately consult with the other signatories to attempt to develop an amendment per Stipulation XII, above. If within thirty (30) days (or another time period agreed to by all signatories) an amendment cannot be reached, any signatory may terminate the MOA upon written notification to the other signatories.

If the MOA is terminated, the Applicant must halt work and prior to work continuing on the undertaking, Corps must either (a) execute an MOA pursuant to 36 CFR § 800.6 or (b) request, take into account, and respond to the comments of the ACHP under 36 CFR § 800.7. Corps shall notify the signatories as to the course of action it will pursue.

Execution of this MOA by the Corps and the SHPO and implementation of its terms

evidence that the Corps has taken into account the effects of this undertaking on historic properties and afforded the ACHP an opportunity to comment.

XIV. EXECUTION AND COUNTERPARTS

This MOA may be executed in counterparts. A copy with all original executed signature pages affixed shall constitute the original MOA. The date of the execution shall be the date of the signature of the last party to sign.

[SIGNATURE PAGE FOLLOWS]

IN WITNESS WHEREOF, the parties hereto have caused this MOA to be executed by their duly authorized representative of the last signed date.

SIGNATORIES:

U.S. Army Corps of Engineers, Charleston District

By: _____ Date _____

Print Name: _____

Title: _____

South Carolina Department of Archives and History, SHPO

By: _____ Date _____

Print Name: _____

Title: _____

Dominion Energy South Carolina, Inc. - Dominion

By: _____ Date _____

Print Name: _____

Title: _____

ATTACHMENTS

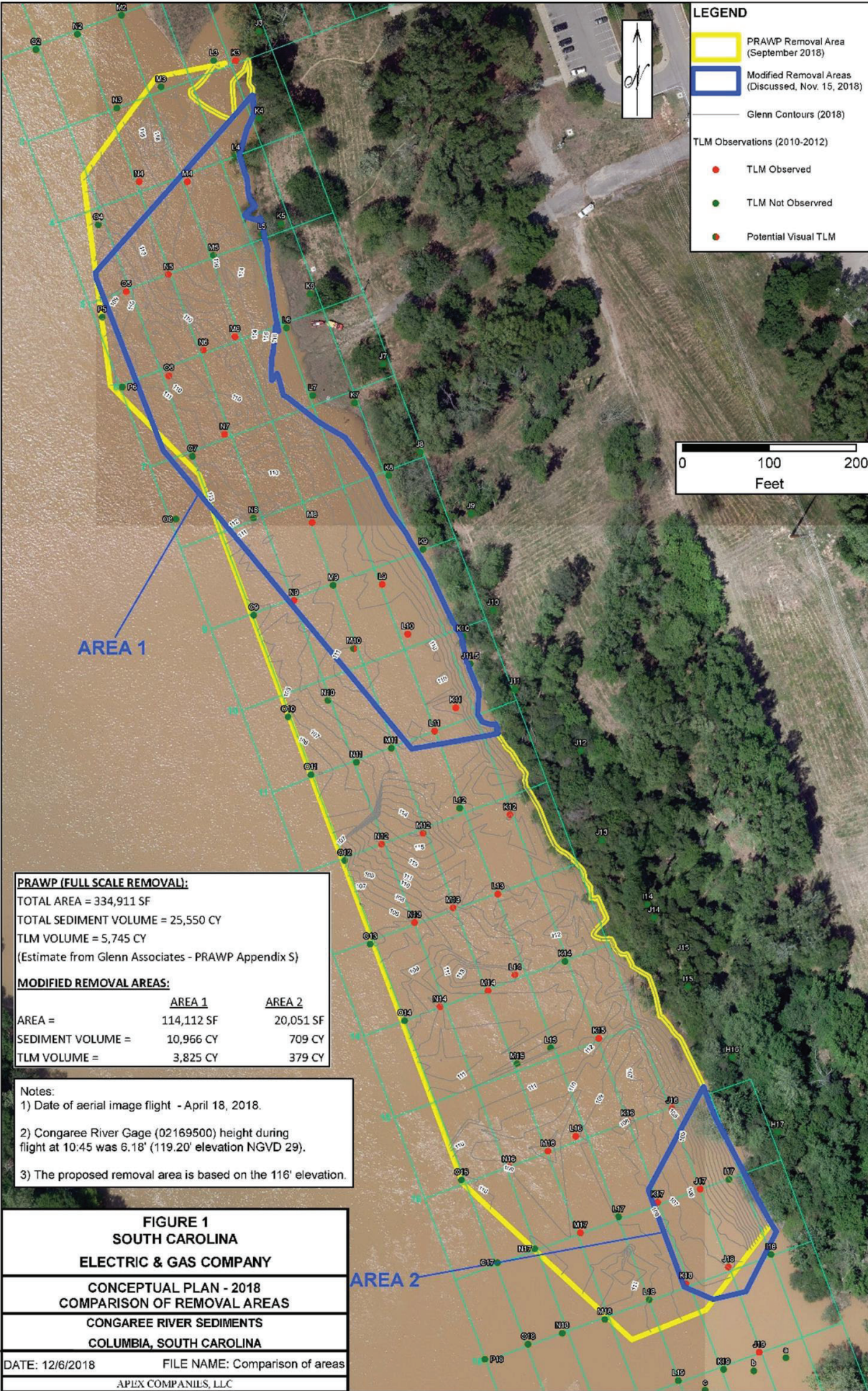

LEGEND

- PRAWP Removal Area (September 2018)
- Modified Removal Areas (Discussed, Nov. 15, 2018)
- Glenn Contours (2018)
- TLM Observed
- TLM Not Observed
- Potential Visual TLM



PRAWP (FULL SCALE REMOVAL):
 TOTAL AREA = 334,911 SF
 TOTAL SEDIMENT VOLUME = 25,550 CY
 TLM VOLUME = 5,745 CY
 (Estimate from Glenn Associates - PRAWP Appendix S)

MODIFIED REMOVAL AREAS:

	AREA 1	AREA 2
AREA =	114,112 SF	20,051 SF
SEDIMENT VOLUME =	10,966 CY	709 CY
TLM VOLUME =	3,825 CY	379 CY

- Notes:**
- 1) Date of aerial image flight - April 18, 2018.
 - 2) Congaree River Gage (02169500) height during flight at 10:45 was 6.18' (119.20' elevation NGVD 29).
 - 3) The proposed removal area is based on the 116' elevation.

FIGURE 1
SOUTH CAROLINA
ELECTRIC & GAS COMPANY

CONCEPTUAL PLAN - 2018
COMPARISON OF REMOVAL AREAS
CONGAREE RIVER SEDIMENTS
COLUMBIA, SOUTH CAROLINA

DATE: 12/6/2018 FILE NAME: Comparison of areas
 APLX COMPANIES, LLC